

# NEWS

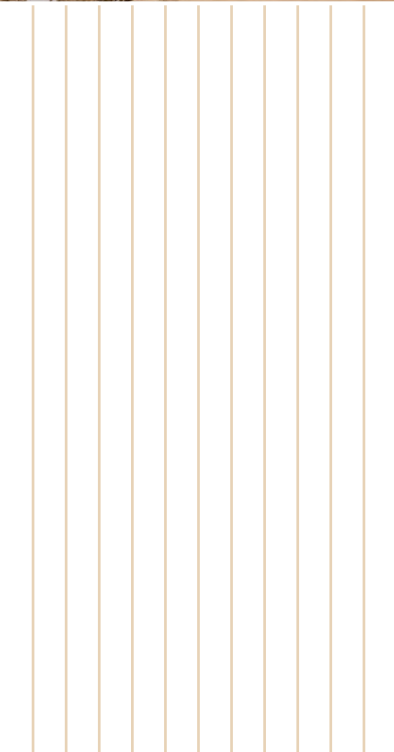

# 2025



Tischleuchte · Table lamp

excl. 1 x E14  
max. 10 W

516900106  
516900180

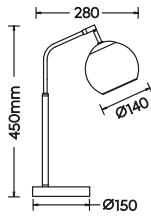

Stehleuchte · Floor lamp

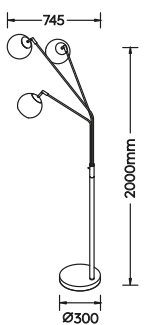

excl. 3 x E27  
max. 10 W

416900306  
416900380



# PAXTON

Metall · Metal

-  **06** | Chrome, Glas transparent irisierend ·  
chrome, glass transparent iridescent
-  **80** | Schwarz-Gold, Glas amber ·  
black-gold, glass amber





# EMERSON

Metall · Metal



Lichtfarbe stufenlos einstellbar ·  
Light color infinitely variable



4 fach TOUCH ·  
4 level Touch function



Innovative Höhenverstellung  
ohne Gegengewicht ·  
Innovative height adjustment  
without counterweight

Pendelleuchte · Pendant

incl. SMD-LED  
22 W / 2.500 Lumen  
2.700 - 5.000 Kelvin

346710107

346710176

346710180

IP20

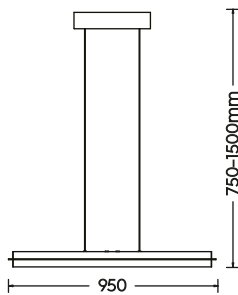

07 | Nickel matt · nickel mat



76 | Warm Grau · warm grey



80 | Schwarz-Gold · black-gold

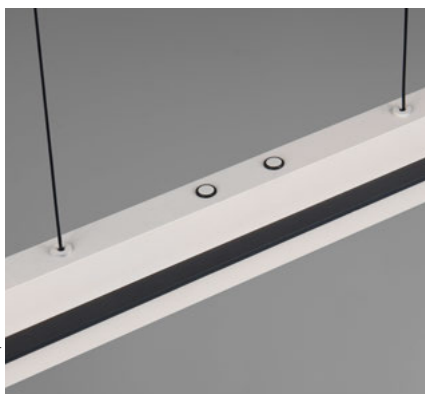



# GRAHAM

Metall · Metal

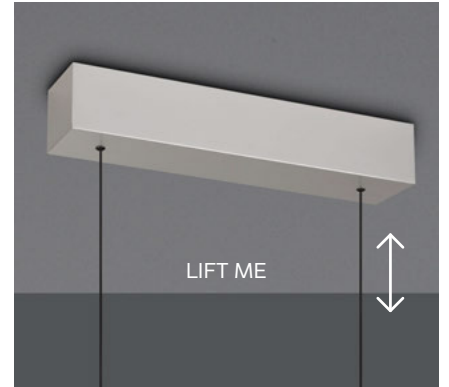

Lichtfarbe einstellbar ·  
Adjustable light color



Integrierter Dimmer ·  
Integrated dimmer



Innovative Höhenverstellung  
ohne Gegengewicht ·  
Innovative height adjustment  
without counterweight

Pendelleuchte · Pendant  
incl. SMD-LED  
7 x 4,5 W / 7 x 480 Lumen  
1 x 10 W / 920 Lumen  
2.300 + 3.000 + 4.000 Kelvin  
**353010107**  
**353010132**



IP20

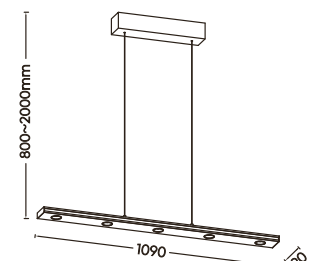



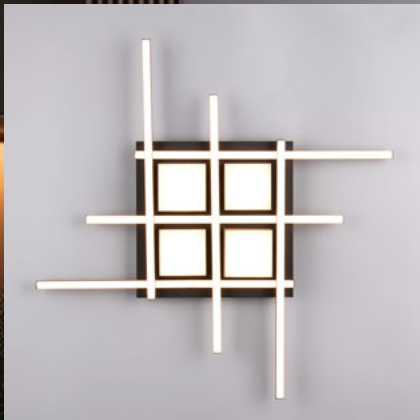

07 | Nickel matt · nickel mat

32 | Schwarz matt · black mat



# ROGER

Metall  
Metal

-  Lichtfarbe stufenlos einstellbar ·  
Light color infinitely variable
-  Integrierter Dimmer ·  
Integrated dimmer
-  SWITCH DIMMER
-  Memory Funktion ·  
Memory function

Deckenleuchte · Ceiling lamp  
incl. SMD-LED  
35 W / 4.050 Lumen  
2.700 - 6.500 Kelvin

647810407  
647810432  
647810465

-    IP20

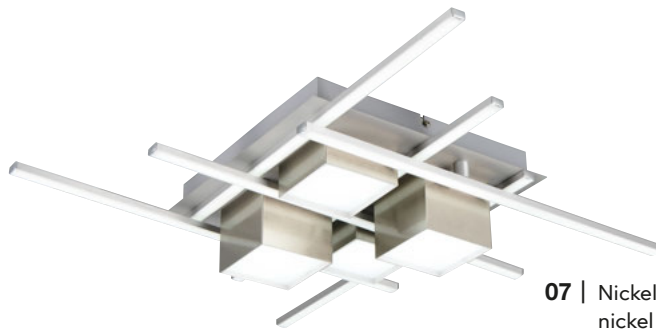
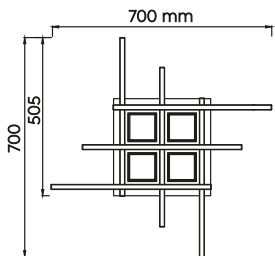

07 | Nickel matt / Aluminium gebürstet ·  
nickel mat / brushed Aluminium



32 | Schwarz matt · black mat

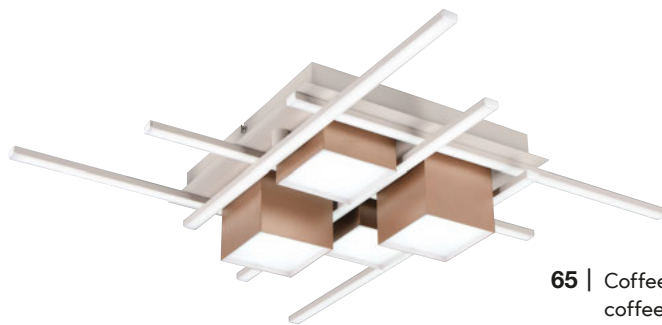

65 | Coffee / Warm Grau ·  
coffee / warm grey

# GILLAN

Metall  
Metal



**07** | Nickel matt / Weiß matt ·  
nickel mat / white mat



**65** | Coffee / Schwarz matt ·  
coffee / black mat

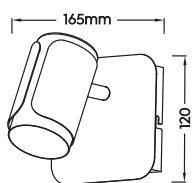

Strahler · Spot  
excl. 1 x GU10  
max. 10 W

**814570107**  
**814570165**



Strahler · Spot  
excl. 3 x GU10  
max. 10 W

**814530307**  
**814530365**

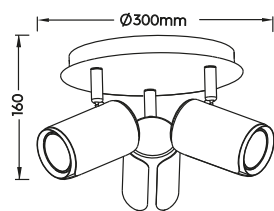

Strahler · Spot  
excl. 2 x GU10  
max. 10 W

**814500207**  
**814500265**

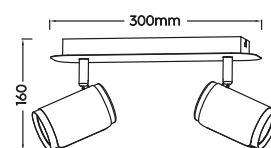

Strahler · Spot  
excl. 4 x GU10  
max. 10 W

**814500407**  
**814500465**

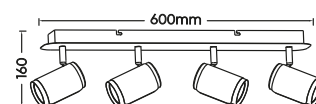



# CHRIS

Metall, Kunststoff weiß  
Metal, plastic white

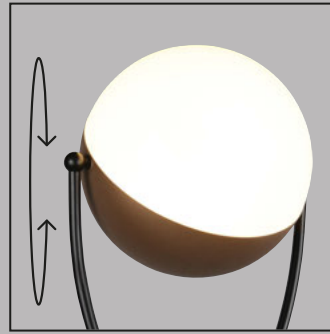

Schwenkbar ·  
Tilttable

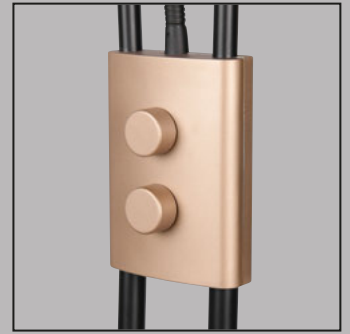

Getrennt schaltbar und dimmbar ·  
Separately switchable and dimmable

● 32 | Schwarz matt · black mat

● 65 | Coffee · coffee

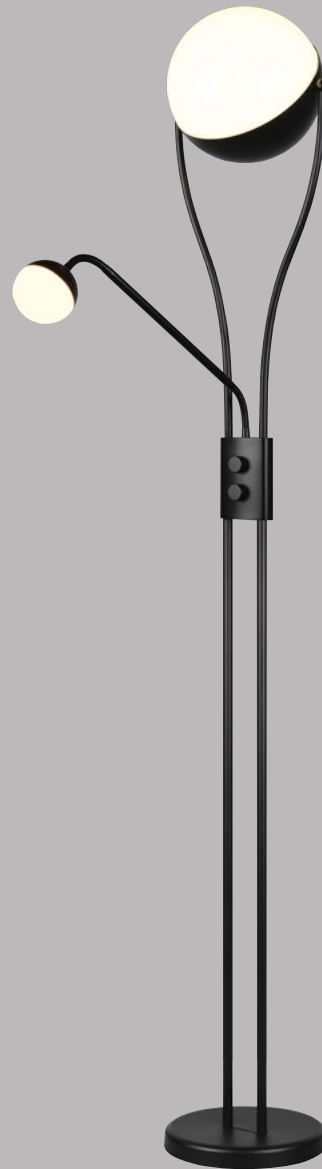

Stehleuchte · Floor lamp  
incl. SMD-LED  
18 W / 2.000 Lumen  
3.000 Kelvin  
3,8 W / 350 Lumen  
3.000 Kelvin  
478310232  
478310265

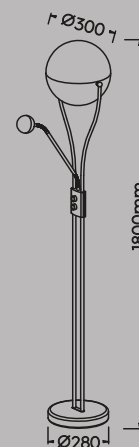



Tischleuchte · Table lamp  
 excl. 1 x E14  
 max. 28 W  
**506200165**

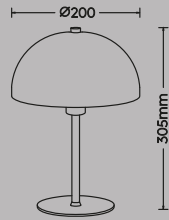

# NOLA

Metall, Coffee  
 Metal, coffee



Tischleuchte · Table lamp  
 excl. 1 x E27  
 max. 40 W  
**506290165**

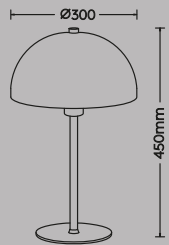

# MARLEY

Metall, Coffee / Warm Grau  
 Metal, coffee / warm grey

Tischleuchte · Table lamp  
 excl. 1 x GU10  
 max. 5 W  
**512400165**



Stehleuchte · Floor lamp  
 excl. 1 x GU10  
 max. 5 W  
**412400165**

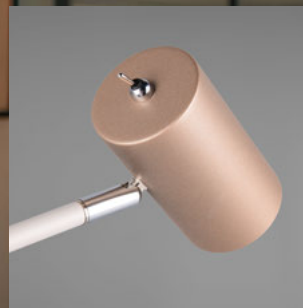
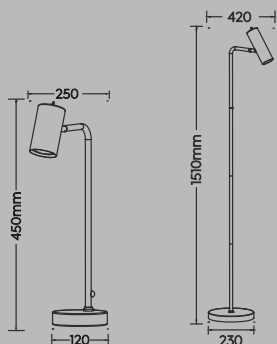





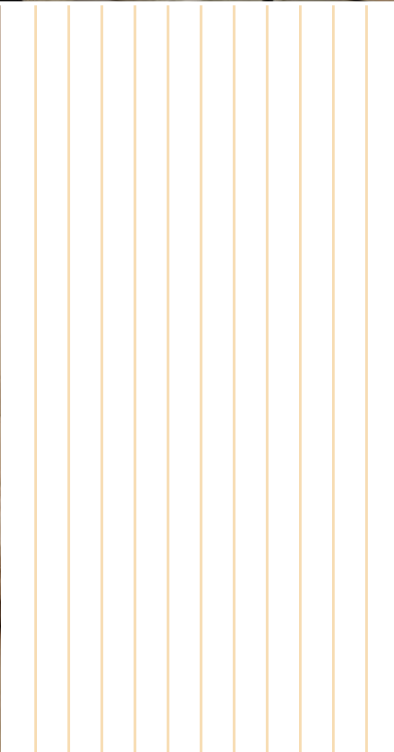

NEW  
COLLECTION



# LAURINE

Papiergarn Braun,  
Metall Schwarz matt

Paper yarn brown,  
metal black mat



Pendelleuchte · Pendant  
excl. 1 x E27  
max. 40 W  
R36161026



Pendelleuchte · Pendant  
excl. 1 x E27  
max. 40 W  
R36161926

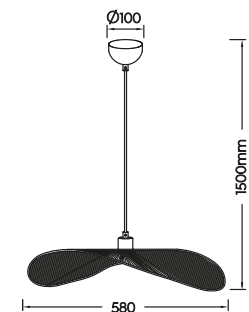
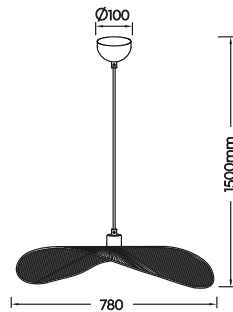

# VALERIE

Jute naturbelassen,  
Metall Schwarz matt

Jute natural finish,  
metal black mat

Pendelleuchte · Pendant  
excl. 1 x E27  
max. 40 W  
R31881036









# ROSALIE

Papier Braun,  
Metall Schwarz matt  
Paper brown,  
metal black mat

Pendelleuchte · Pendant

excl. 1 x E27  
max. 28 W

R36191036



# LUCILLE

Papiergarn Braun,  
Metall Schwarz matt  
Paper yarn brown,  
metal black mat

Pendelleuchte · Pendant

excl. 1 x E27  
max. 28 W

R36111026

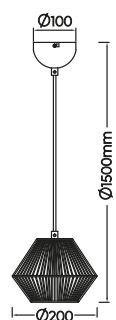

# BIJOU

Papiergarn Braun,  
Metall Schwarz matt  
Paper yarn brown,  
metal black mat



Pendelleuchte · Pendant  
excl. 1 x E27  
max. 10 W  
R31831026

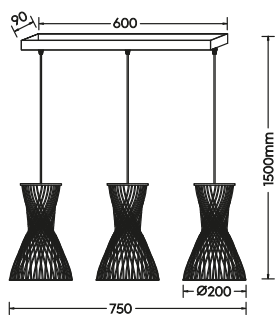

Pendelleuchte · Pendant  
excl. 3 x E27  
max. 10 W  
R31833026







# JOELINE

Papiergarn Braun,  
Metall Schwarz matt  
Paper yarn brown,  
metal black mat

Pendelleuchte · Pendant  
excl. 1 x E27  
max. 10 W  
R31731926

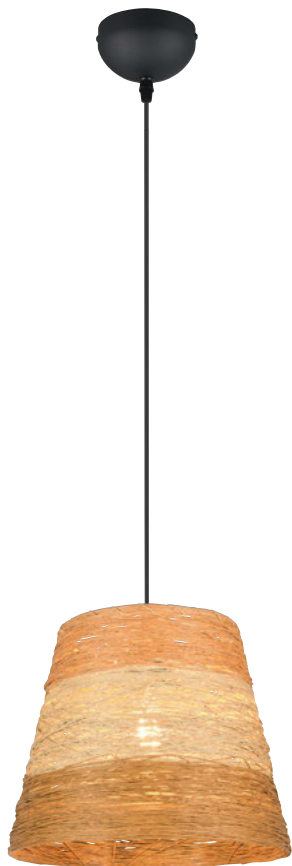
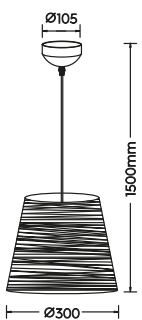

Pendelleuchte · Pendant  
excl. 1 x E27  
max. 10 W  
R31731026

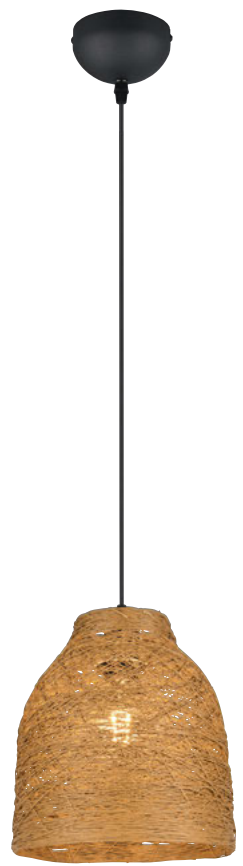
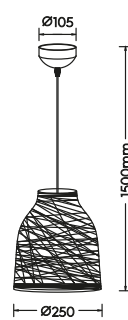



# JEAN

Wasserhyazinthe naturbelassen,  
Metall Schwarz matt,  
Bambus naturbelassen  
Water hyacinth natural finish  
metal black mat,  
bamboo natural finish

Pendelleuchte · Pendant

excl. 1 x E27  
max. 10 W

R36221036

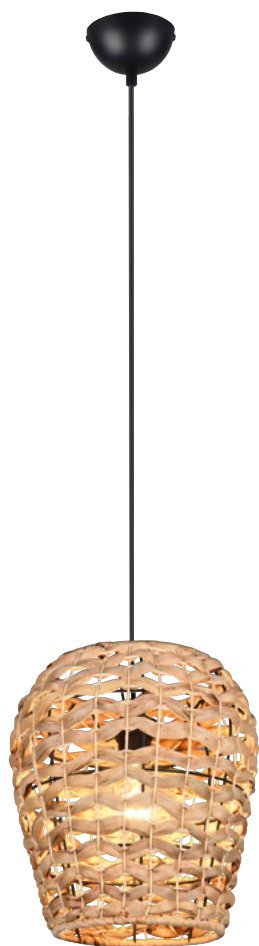
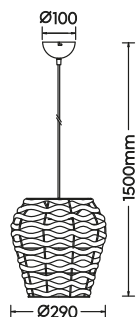

Tischleuchte · Table lamp

excl. 1 x E27  
max. 10 W

R56221036



# HIVE

Metall Schwarz matt,  
Hanf naturbelassen  
Metal black mat,  
natural hemp



Wandleuchte · Wall lamp  
excl. 1 x E27  
max. 10 W  
**R21681736**

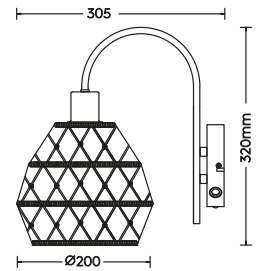

Stehleuchte · Floor lamp  
excl. 1 x E27  
max. 60 W  
**R41681036**

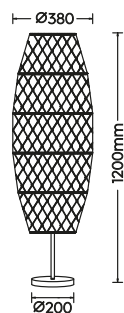

Tischleuchte · Table lamp  
excl. 1 x E27  
max. 10 W  
**R51681036**

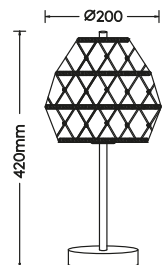





Deckenleuchte · Ceiling lamp  
excl. 1 x E27  
max. 10 W  
**R61681036**

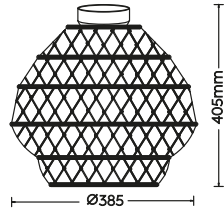

Pendelleuchte · Pendant  
excl. 1 x E27  
max. 10 W  
**R31681936**

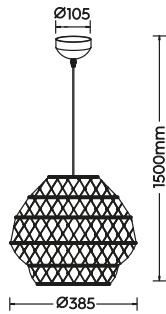

Pendelleuchte · Pendant  
excl. 1 x E27  
max. 60 W  
**R31681036**

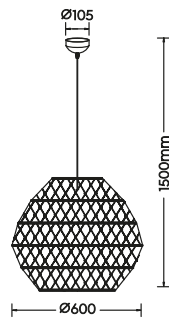





# SANDRINE

Metall Schwarz matt,  
Rattengeflecht naturbelassen  
Metal black mat  
rattan meshwork natural finish

Pendelleuchte · Pendant

excl. 1 x E27

max. 28 W

R36211032

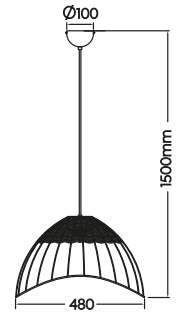



# JEROME

Metall Schwarz matt,  
Rattangeflecht naturbelassen  
Metal black mat  
rattan meshwork natural finish

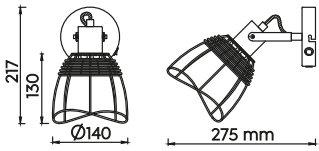

Strahler · Spot  
excl. 1 x E27  
max. 10 W  
R86231732

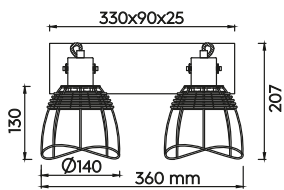

Strahler · Spot  
excl. 2 x E27  
max. 10 W  
R86232032

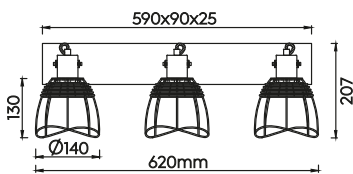

Strahler · Spot  
excl. 3 x E27  
max. 10 W  
R86233032



Tischleuchte · Table lamp  
excl. 1 x E27  
max. 10 W  
R56231032

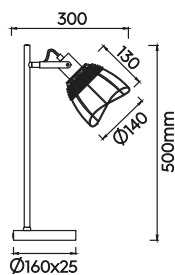



# LAURENT

Bambus naturbelassen,  
Metall Schwarz matt  
Bamboo natural finish,  
metal black mat



Wandleuchte · Wall lamp

excl. 1 x E27  
max. 10 W

R26091732

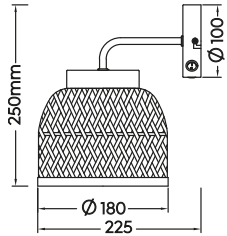

Strahler · Spot

excl. 2 x E14  
max. 10 W

R86092032

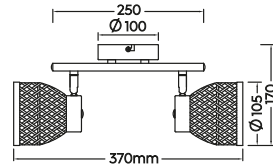

Strahler · Spot

excl. 1 x E14  
max. 10 W

R86091732

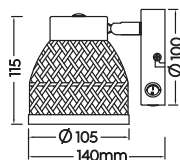

Strahler · Spot

excl. 3 x E14  
max. 10 W

R86093032

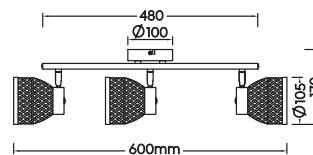



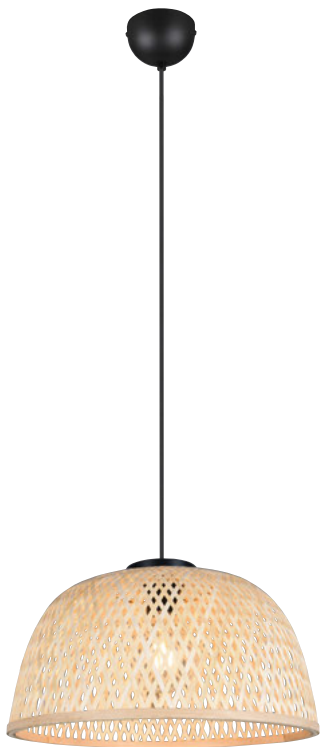

Pendelleuchte · Pendant  
excl. 1 x E27  
max. 28 W  
R36091032

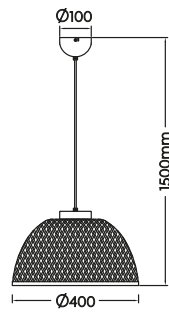

Tischleuchte · Table lamp  
excl. 1 x E14  
max. 10 W  
R56091032

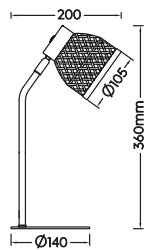

Tischleuchte · Table lamp  
excl. 1 x E27  
max. 10 W  
R56091932

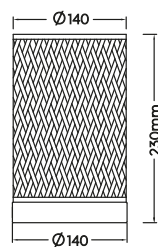



Wandleuchte · Wall lamp

excl. 1 x E27  
max. 10 W

**R21851736**

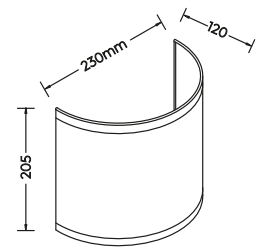

Tischleuchte · Table lamp

excl. 1 x E27  
max. 10 W

**R51851036**

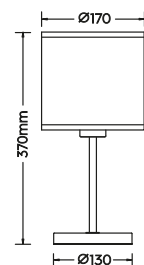





## AIMEE

Metall Schwarz matt,  
Bast naturbelassen  
Metal black mat,  
natural bast

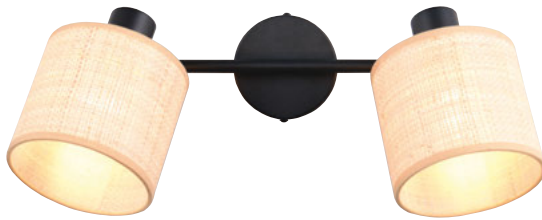

Strahler · Spot  
excl. 2 x E14  
max. 10 W  
R81852036

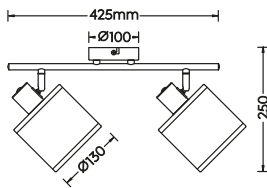

Strahler · Spot  
excl. 1 x E14  
max. 10 W  
R81851736

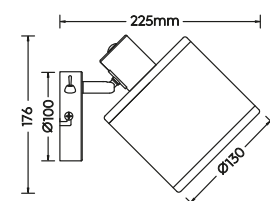

Strahler · Spot  
excl. 4 x E14  
max. 10 W  
R81854036

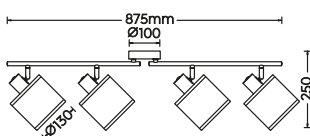





# SATNA

Papiergarn Braun,  
Metall Weiß  
Paper yarn brown,  
metal white



Wandleuchte · Wall lamp  
excl. 1 x E27  
max. 25 W  
R20071026

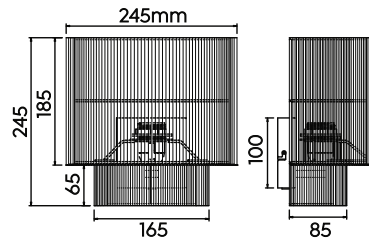

# ALICE

Metall Schwarz matt,  
Holz naturbelassen  
Metal black mat,  
wood natural finish



Wandleuchte · Wall lamp  
excl. 1 x E27  
max. 10 W  
R21861736

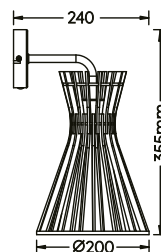

# BINA

Bambus naturbelassen,  
Metall Beige  
Bamboo natural finish,  
metal fawn



Wandleuchte · Wall lamp  
excl. 1 x E27  
max. 25 W  
R20101026

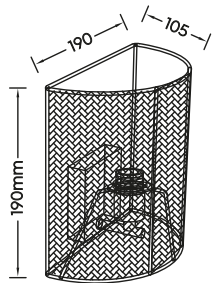

# LEONIE

Bambus naturbelassen,  
Metall Schwarz matt  
Bamboo natural finish,  
metal black mat



Wandleuchte · Wall lamp  
excl. 1 x E27  
max. 10 W  
R21871736

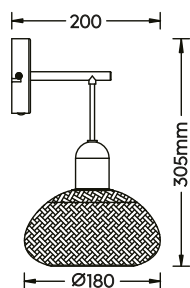





## AMELIE

Bambus naturbelassen,  
Metall Schwarz matt  
Natural bamboo,  
metal black mat

Pendelleuchte · Pendant  
excl. 1 x E27  
max. 10 W  
R31941036

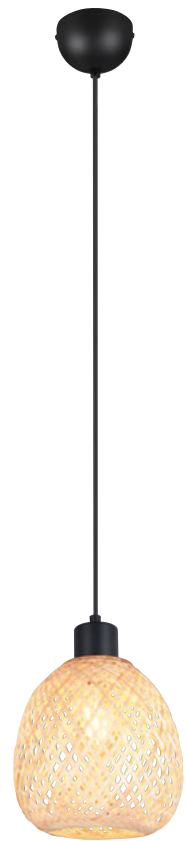
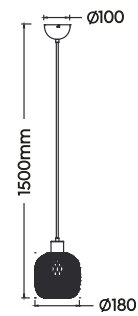

## PAULETTE

Papiergarn Braun,  
Metall Schwarz matt  
Paper yarn brown,  
metal black mat

Pendelleuchte · Pendant  
excl. 1 x E27  
max. 40 W  
R36141026

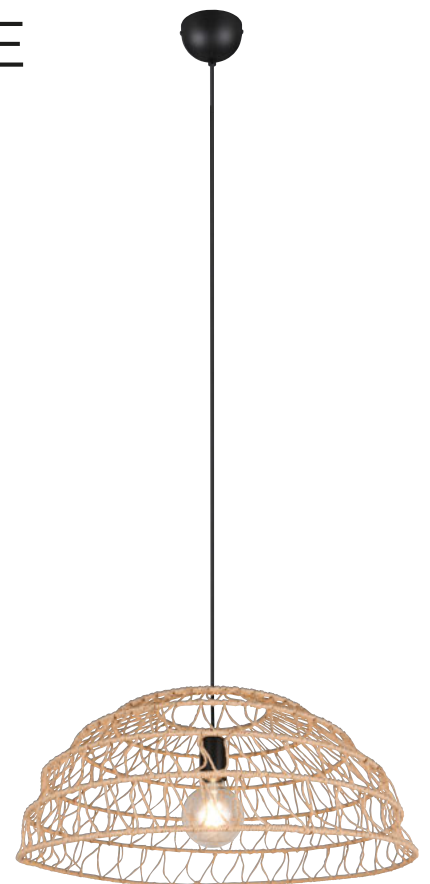
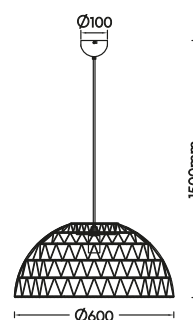



## FLEURE

Metall Schwarz matt  
Metal black mat

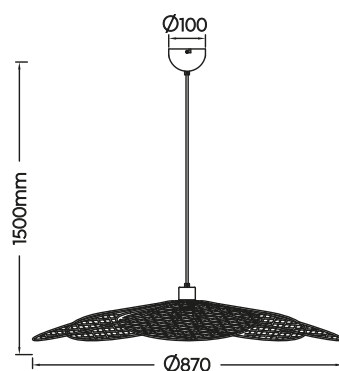

Pendelleuchte · Pendant  
excl. 1 x E27  
max. 60 W  
**R36291032**







# MADELINE

Stoff weiß, Metall Schwarz matt  
Fabric white, metal black mat

Deckenleuchte · Ceiling lamp  
excl. 1 x E27  
max. 10 W  
**R61971001**

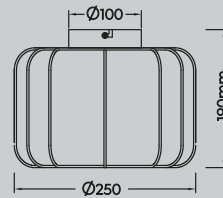

Deckenleuchte · Ceiling lamp  
excl. 1 x E27  
max. 10 W  
**R61971901**

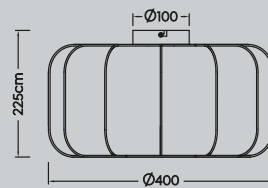

# JANINE

Stoff weiß, Metall Weiß  
Fabric white, metal white

Pendelleuchte · Pendant  
excl. 1 x E27  
max. 40 W  
**R36241001**

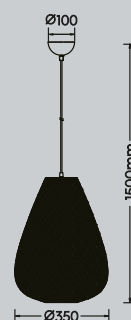

# MADELINE

Stoff weiß, Metall Schwarz matt  
Fabric white, metal black mat

Pendelleuchte · Pendant

excl. 1 x E27

max. 10 W

R31971001

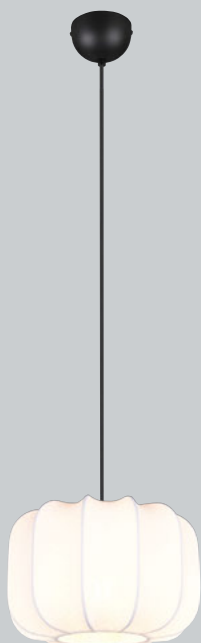

Pendelleuchte · Pendant

excl. 1 x E27

max. 10 W

R31971901

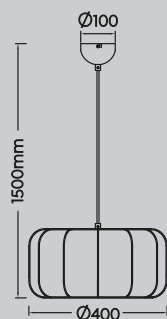
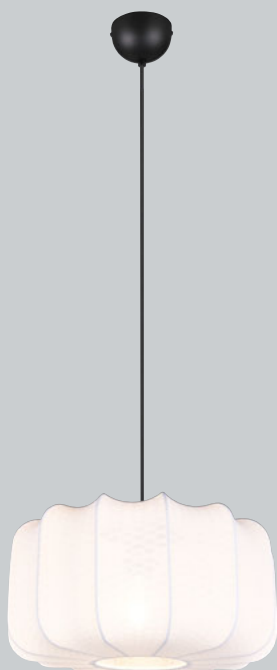

Tischleuchte · Table lamp

excl. 1 x E27

max. 10 W

R51971001

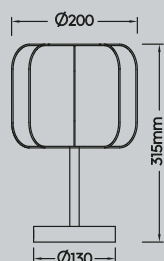





# VALENTIN

Metall, Holznachbildung  
Metal, wood imitation



Strahler · Spot  
excl. 1 x E14  
max. 10 W  
R81921731  
R81921732

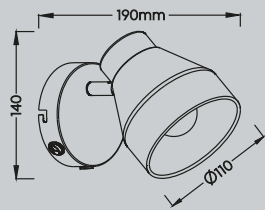

Strahler · Spot  
excl. 2 x E14  
max. 10 W  
R81922031  
R81922032

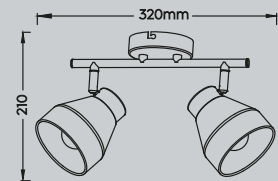

Strahler · Spot  
excl. 4 x E14  
max. 10 W  
R81924031  
R81924032

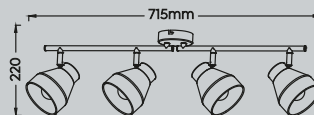

# PIERRE

Metall, Holz naturbelassen  
Metal, wood natural finish



**31** | Weiß matt · white mat



Strahler · Spot  
excl. 1 x GU10  
max. 10 W  
**R81981731**  
**R81981732**

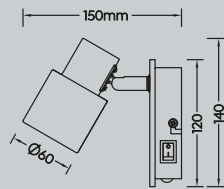

Strahler · Spot  
excl. 2 x GU10  
max. 10 W  
**R81982031**  
**R81982032**

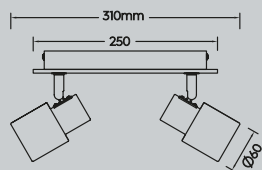

Strahler · Spot  
excl. 3 x GU10  
max. 10 W  
**R81983031**  
**R81983032**

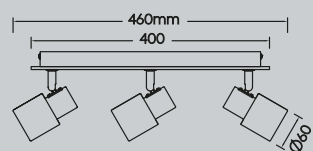





# RL



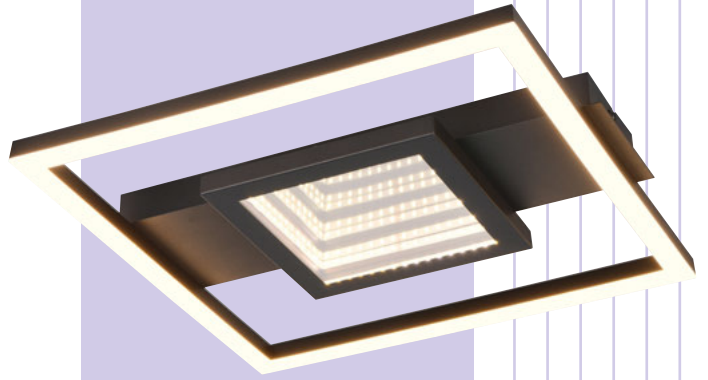

live your light





# GINKO

Metall, Kunststoff weiß  
Metal, plastic white

-  **31** | Weiß matt · white mat 
-  **32** | Schwarz matt · black mat
-  **66** | Sand · sable



## Wandleuchte · Wall lamp

incl. SMD-LED  
11 W / 1.150 Lumen  
3.000 Kelvin

**R25791732**  
**R25791766**

incl. SMD-LED  
11 W / 1.250 Lumen  
4.000 Kelvin

**R25791731**

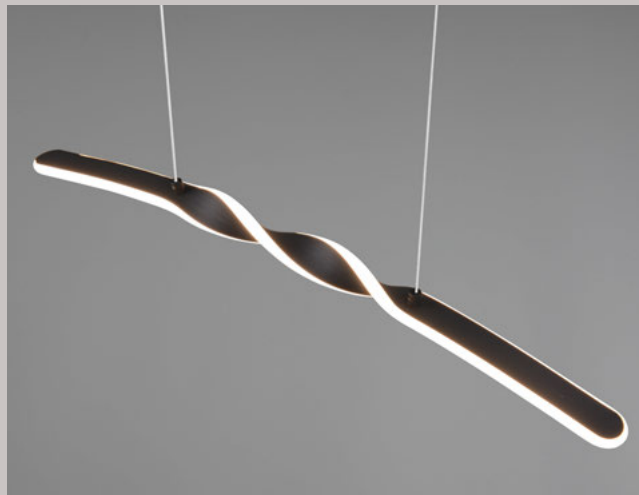
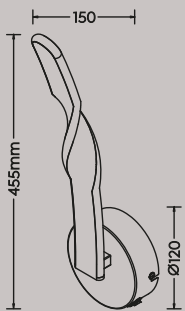

## Pendelleuchte · Pendant

incl. SMD-LED  
18 W / 1.980 Lumen  
3.000 Kelvin

**R35791132**  
**R35791166**

incl. SMD-LED  
18 W / 2.100 Lumen  
4.000 Kelvin

**R35791131**

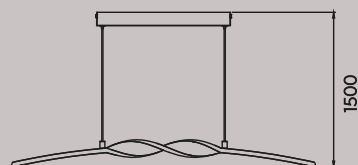
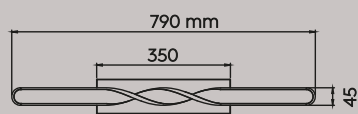

Deckenleuchte · Ceiling lamp

incl. SMD-LED  
18 W / 1.980 Lumen  
3.000 Kelvin

R65791132  
R65791166

incl. SMD-LED  
18 W / 2.100 Lumen  
4.000 Kelvin

R65791131

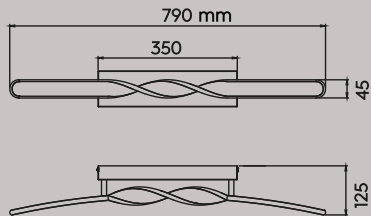

Stehleuchte · Floor lamp

incl. SMD-LED  
19 W / 2.060 Lumen  
3.000 Kelvin

R45791132  
R45791166

incl. SMD-LED  
19 W / 2.100 Lumen  
4.000 Kelvin

R45791131

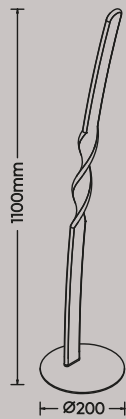

Tischleuchte · Table lamp

incl. SMD-LED  
10 W / 1.020 Lumen  
3.000 Kelvin

R55791132  
R55791166

incl. SMD-LED  
10 W / 1.070 Lumen  
4.000 Kelvin

R55791131

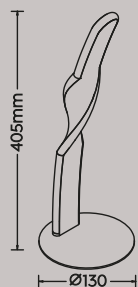





# JASON

Metall Schwarz matt, Kunststoff  
Metal black mat, plastic

64 | bronzefarbig · bronze

79 | goldfarbig · gold

Pendelleuchte · Pendant

excl. 4 x E14

max. 10 W

R36304064

R36304079



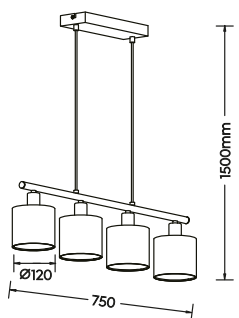

IP20



# PALERMO

Metall, Kunststoff  
Metal, plastic

 Lichtfarbe stufenlos einstellbar ·  
Light color infinitely variable

 Integrierter Dimmer ·  
Integrated dimmer

 Memory Funktion ·  
Memory function

 **07** | Nickel matt · nickel mat

 **32** | Schwarz matt · black mat

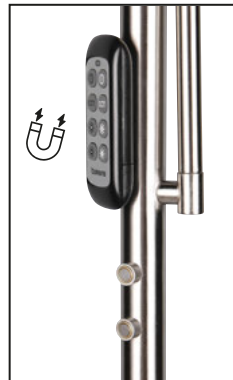

Stehleuchte · Floor lamp  
incl. SMD-LED  
23 W / 2.500 Lumen  
4,5 W / 380 Lumen  
3.000 + 4.000 + 6.500 Kelvin  
**R45741107**  
**R45741132**

  IP20



# GERRY

Metall Schwarz matt, Glas chrom bedampft  
Metal black mat, chrome plated glass

Stehleuchte · Floor lamp

excl. 2 x E27

max. 18 W

excl. 1 x E14

max. 10 W

**R40063132**

    IP20

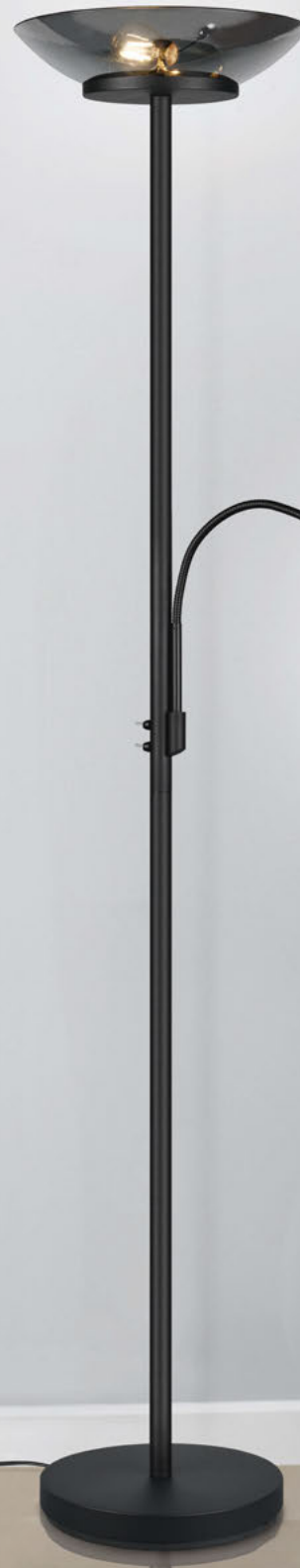
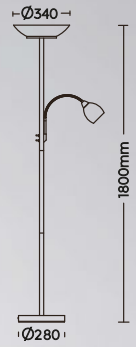



# WHEELER

Metall Weiß matt, Kunststoff  
Metal white mat, plastic



Deckenleuchte · Ceiling lamp

incl. SMD-LED  
16 W / 2.000 Lumen  
4.000 Kelvin  
**R64801931**

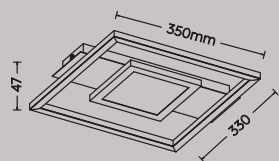

Deckenleuchte · Ceiling lamp

incl. SMD-LED  
16 W / 2.000 Lumen  
4.000 Kelvin  
**R64801131**

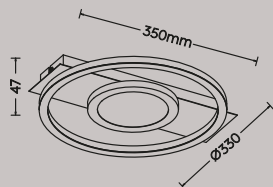

# WHEELER

Metall Schwarz matt, Kunststoff  
Metal black mat, plastic



Die optische Illusion der zahlreichen Lichtpunkte schaffen eine beeindruckende Tiefenwirkung.

The optical illusion of the light points creates an impressive depth effect.



Deckenleuchte · Ceiling lamp  
incl. SMD-LED  
16 W / 2.000 Lumen  
3.000 Kelvin  
**R64801932**

IP20

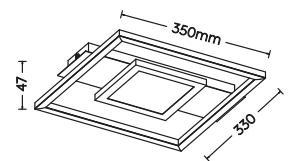

Deckenleuchte · Ceiling lamp  
incl. SMD-LED  
16 W / 2.000 Lumen  
3.000 Kelvin  
**R64801132**

IP20

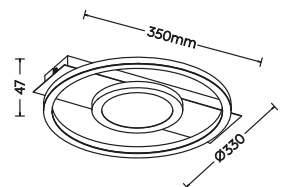



# UMBRIA

Metall Weiß, Kunststoff alabasterfarbig  
Metal white, plastic alabaster



Wandleuchte · Wall lamp

incl. SMD-LED  
9 W / 1.200 Lumen  
4.000 Kelvin

**R24631101**

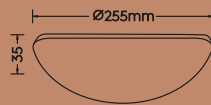

Deckenleuchte · Ceiling lamp

incl. SMD-LED  
12 W / 1.600 Lumen  
4.000 Kelvin

**R64631101**

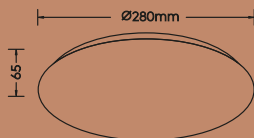

Deckenleuchte · Ceiling lamp

incl. SMD-LED  
23 W / 3.200 Lumen  
4.000 Kelvin

**R64631901**

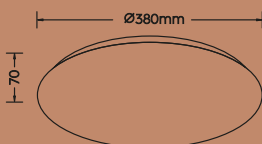

# ATARIS

Kunststoff Weiß  
Plastic white



Lichtfarbe stufenlos einstellbar ·  
Light color infinitely variable



SWITCH DIMMER



Memory Funktion ·  
Memory function



Deckenleuchte · Ceiling lamp

incl. SMD-LED  
18 W / 1.900 Lumen  
2.700 - 6.000 Kelvin

**R64791101**

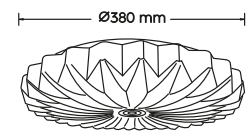

# SIRIUS

Metall Weiß matt, Kunststoff weiß  
Metal white mat, plastic white



Bewegungssensor  
Motion sensor



Deckenleuchte · Ceiling lamp

incl. SMD-LED  
19 W / 2.050 Lumen  
3.000 Kelvin

**R64601131**

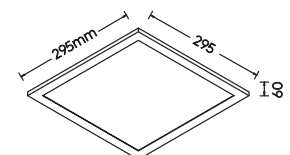

# LUMOS

Metall, Kunststoff  
Metal, plastic



09

Deckenleuchte · Ceiling lamp

incl. SMD-LED  
26,5 W / 3.100 Lumen  
3.000 Kelvin

R64821109 MDF aluminiumfarbig,  
Metall Schwarz matt ·  
MDF aluminium,  
metal black mat

incl. SMD-LED  
26,5 W / 3.300 Lumen  
4.000 Kelvin

R64821106 Metall Chrom und  
titanfarbig ·  
Metal chrome and titan



06

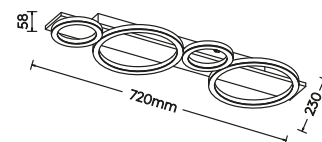

# VARDA

Metall, Kunststoff  
Metal, plastic



01

02

 Lichtfarbe stufenlos einstellbar ·  
Light color infinitely variable

 SWITCH DIMMER

 Memory Funktion ·  
Memory function

Deckenleuchte · Ceiling lamp

incl. SMD-LED  
24 W / 2.500 Lumen  
2.700 - 6.500 Kelvin

R64811101 Weiß · white

R64811102 Schwarz · black

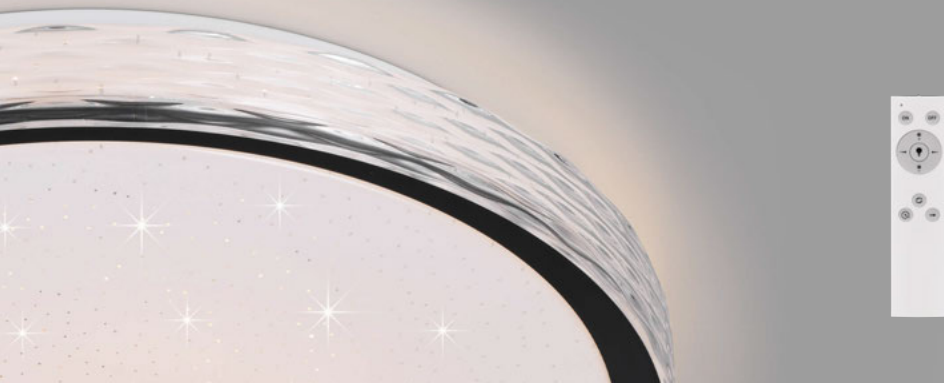
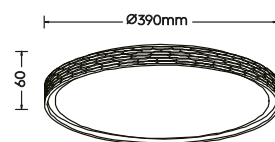

Strahler · Spot

excl. 1 x E14  
max. 10 W

R81571731

R81571765

R81571780

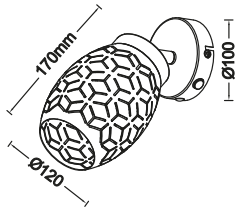

Strahler · Spot

excl. 2 x E14  
max. 10 W

R81572031

R81572065

R81572080

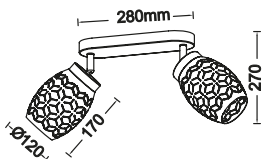

Deckenleuchte · Ceiling lamp

excl. 3 x E14  
max. 10 W

R61573331

R61573365

R61573380

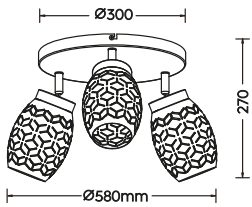

Strahler · Spot

excl. 4 x E14  
max. 10 W

R81574031

R81574065

R81574080

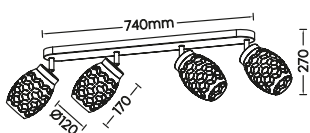



# BIDAR

Metall, Holz naturbelassen  
Metal, wood natural finish

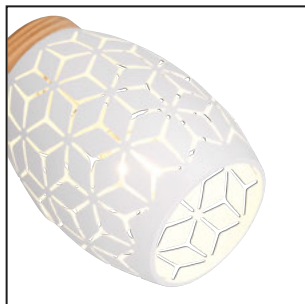

31 | Weiß matt · white mat

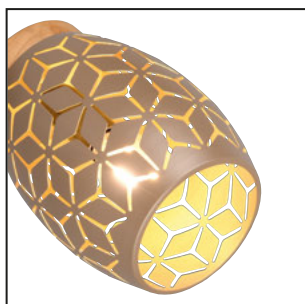

65 | Coffee · coffee



80 | Schwarz-Gold · black-gold

Stehleuchte · Floor lamp

excl. 1 x E27  
max. 10 W

R41571031

R41571065

R41571080

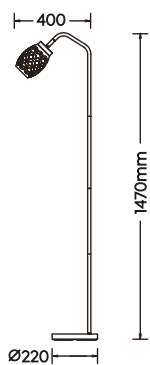



Klemmspot · Clamp spot

incl. SMD-LED  
4,5 W / 500 Lumen  
3.000 Kelvin

R25831101  
R25831102  
R25831115  
R25831143

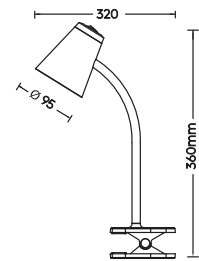

- 01 | Weiß · white
- 02 | Schwarz · black
- 15 | Grün · green
- 43 | Warm beige · warm fawn



Tischleuchte · Table lamp

incl. SMD-LED  
4,5 W / 500 Lumen  
3.000 Kelvin

R55831101  
R55831102  
R55831115  
R55831143

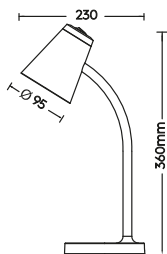

# PONGO

Kunststoff  
Plastic

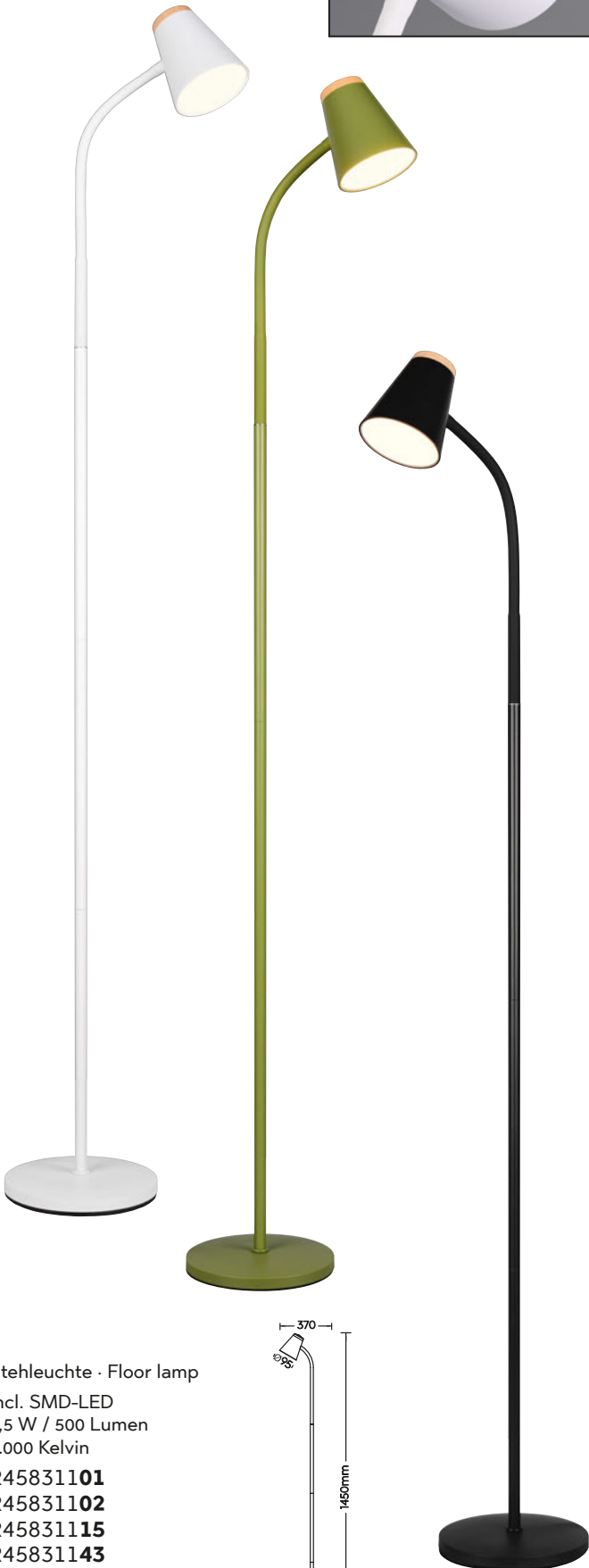

Stehleuchte · Floor lamp

incl. SMD-LED  
4,5 W / 500 Lumen  
3.000 Kelvin

R45831101  
R45831102  
R45831115  
R45831143

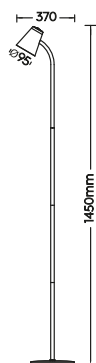





# TACO

Kunststoff Schwarz,  
Stoff Schwarz-Gold  
Plastic black,  
fabric black-gold

Tischleuchte · Table lamp  
incl. SMD-LED  
4 W / 380 Lumen  
3.000 Kelvin  
**R52801002**

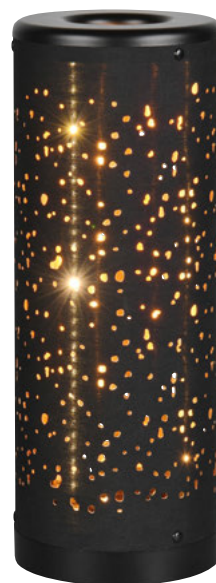
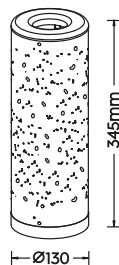

# PAIL

Metall, Stoff  
Metal, fabric



**07** | Nickel matt, Schirm Weiß ·  
nickel mat, shade white



**32** | Schwarz matt, Schirm Weiß ·  
black mat, shade white

Tischleuchte · Table lamp  
excl. 1 x E27  
max. 10 W  
**R55751007**  
**R55751032**  
**R55751065**

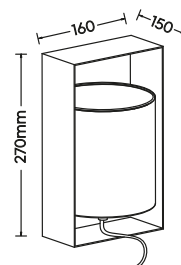

**65** | Coffee, Schirm Taupe ·  
coffee, shade taupe

# CUTIE

Kunststoff  
Plastic



On/Off Touch Funktion ·  
On/Off Touch function



RGB Farbwechsler ·  
RGB Colorchanging



USB Anschluss ·  
USB connection



12 | Blau · blue

15 | Grün · green

93 | Pink · pink



15

Tischleuchte · Table lamp

incl. SMD-LED  
0,3 W / 30 Lumen  
3.000 Kelvin

R57991112

R57991115

R57991193

IP20



12

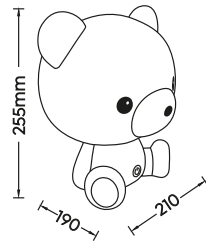

93



15

12 | Blau · blue

15 | Grün · green

93 | Pink · pink

# HOPPER

Kunststoff  
Plastic



On/Off Touch Funktion ·  
On/Off Touch function



RGB Farbwechsler ·  
RGB Colorchanging



USB Anschluss ·  
USB connection



93

Tischleuchte · Table lamp

incl. SMD-LED  
0,3 W / 30 Lumen  
3.000 Kelvin

R57971112

R57971115

R57971193

IP20



12

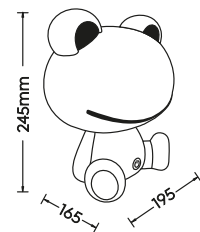





01

# EARL

Metall, Glas · Metal, glass

-  4 fach TOUCH · 4 level Touch function
-  Akkubetrieb · Rechargeable battery operated
-  USB Anschluss · USB connection



15

13

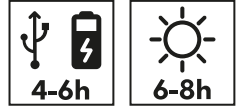

54

Wandleuchte · Wall lamp

incl. SMD-LED  
1,5 W / 140 Lumen  
3.000 Kelvin

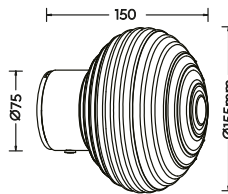

- R27771101 Weiß · white
- R27771113 Amber · amber
- R27771115 Grün · green
- R27771154 rauchfarbig · smoke



15

# FACETTE

Metall Schwarz matt, Glas · Metal black mat, glass

-  4 fach TOUCH · 4 level Touch function
-  Akkubetrieb · Rechargeable battery operated
-  USB Anschluss · USB connection



13

54

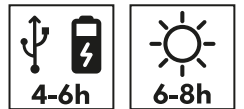

Tischleuchte · Table lamp

incl. SMD-LED  
1,5 W / 140 Lumen  
3.000 Kelvin

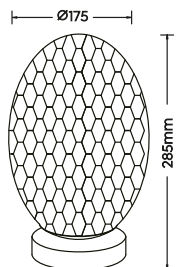

- 564210113 Amber · amber
- 564210115 Grün · green
- 564210154 rauchfarbig · smoke





# DAVEY

Metall · Metal

-  4 fach TOUCH ·  
4 level Touch function
-  Akkubetrieb ·  
Rechargeable battery operated
-  USB Anschluss ·  
USB connection

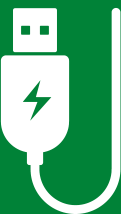
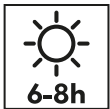
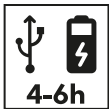

AKKULEUCHTEN  
BATTERY LAMPS

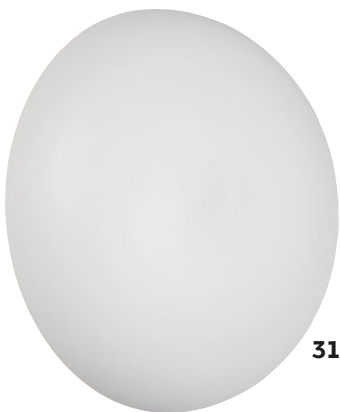

31



32



15

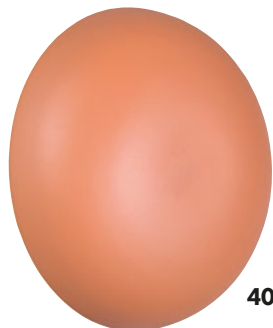

40



43

Wandleuchte · Wall lamp

incl. SMD-LED  
1,5 W / 140 Lumen  
3.000 Kelvin

- R24431115 Grün · green
- R24431131 Weiß matt · white mat
- R24431132 Schwarz matt · black mat
- R24431140 Apricot · apricot
- R24431143 Warm Beige · warm beige

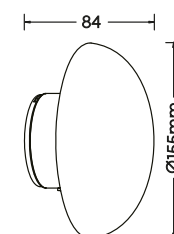

 IP20





# DOOLEY

Metall Schwarz matt, Glas ·  
Metal black mat, glass

-  Akkubetrieb ·  
Rechargeable battery operated
-  4 fach TOUCH ·  
4 level Touch function
-  USB Anschluss ·  
USB connection



54



31

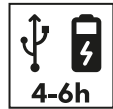

13

Tischleuchte · Table lamp  
incl. SMD-LED  
1,5 W / 140 Lumen  
3.000 Kelvin

- R54981113 Amber · amber
- R54981131 Weiß matt · white mat
- R54981153 Transparent irisierend ·  
transparent iridescent
- R54981154 rauchfarbig · smoke

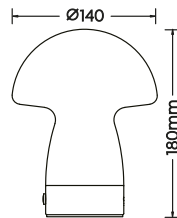



 IP20



# MUNOZ

Metall · Metal

-  4 fach TOUCH ·  
4 level Touch function
-  Akkubetrieb ·  
Rechargeable battery operated
-  USB Anschluss ·  
USB connection



15



32



65

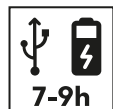

Tischleuchte · Table lamp  
incl. SMD-LED  
1,3 W / 120 Lumen  
3.000 Kelvin

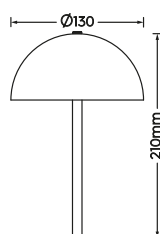

- R54891115 Grün · green
- R54891131 Weiß matt · white mat
- R54891132 Schwarz matt · black mat
- R54891165 Coffee · coffee



 IP20

# SKIP

MDF, Metall · MDF, metal

-  Sensordimmer · Sensor dimmer
-  Akkubetrieb · Rechargeable battery operated
-  USB Anschluss · USB connection

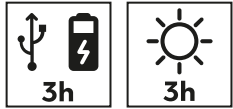

32

Tischleuchte · Table lamp

incl. SMD-LED  
2 W / 185 Lumen  
3.000 Kelvin

R55951132 Schwarz matt · black mat  
R55951135 Holznachbildung · wood imitation

 IP20

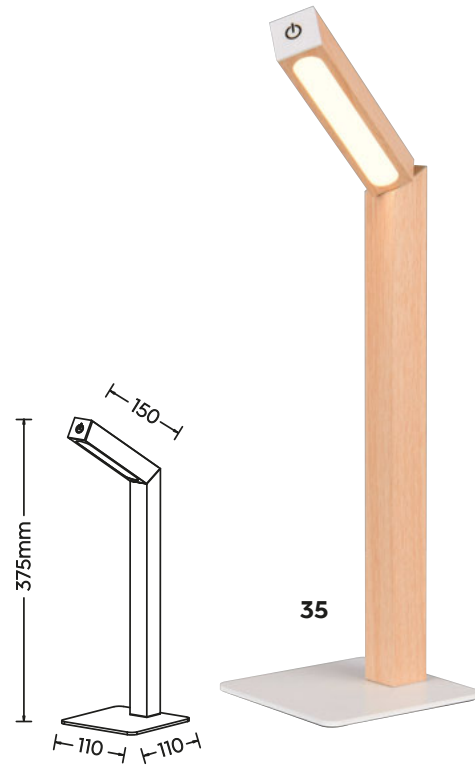

35

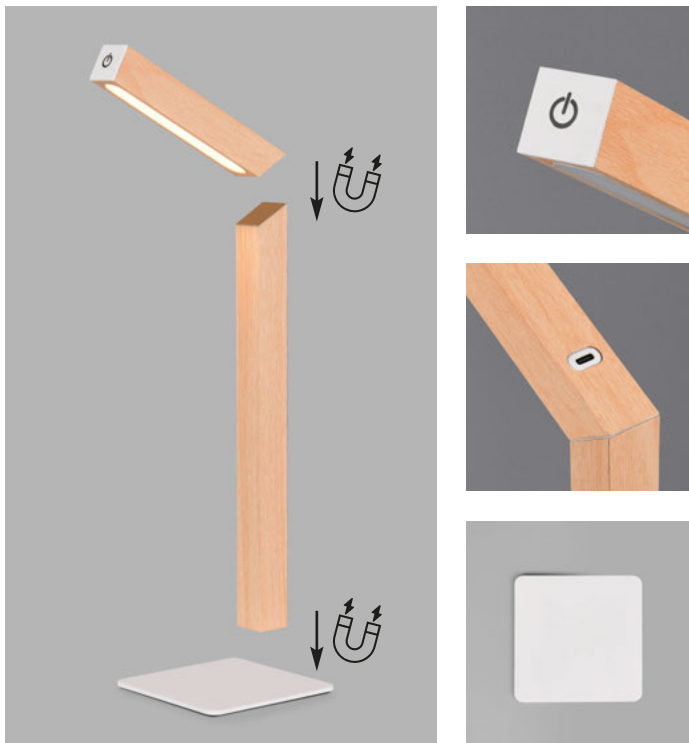

Die Akkutischleuchte SKIP bietet flexible Einsatzmöglichkeiten und ist ideal für jede Umgebung. Dank ihrer magnetischen Verbindungselemente lässt sie sich einfach und jederzeit dort einsetzen, wo Licht benötigt wird, ohne auf einen Stromanschluss angewiesen zu sein.

The SKIP rechargeable table lamp offers flexible application options and is ideal for any environment. Thanks to its magnetic connecting elements, it can be used easily and at any time wherever light is needed without having to rely on a power connection.

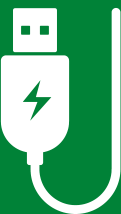

AKKULEUCHTEN  
BATTERY LAMPS







4 fach TOUCH ·  
4 level Touch function



Akkubetrieb ·  
Rechargeable battery operated



USB Anschluss ·  
USB connection

# LIRA

Papiergarn Braun, Metall Schwarz matt ·  
Paper yarn brown, metal black mat



4-6h

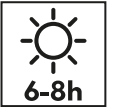

6-8h

Wandleuchte · Wall lamp  
incl. SMD-LED  
1,5 W / 140 Lumen  
3.000 Kelvin  
**R25991126**

Tischleuchte · Table lamp  
incl. SMD-LED  
1,5 W / 140 Lumen  
3.000 Kelvin  
**R55991126**



IP20



IP20

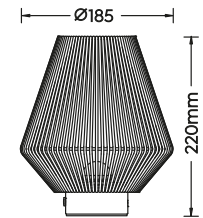
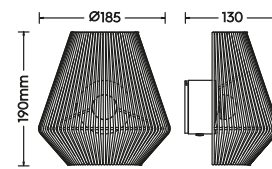

# BLAKE

Metall · Metal



4 fach TOUCH ·  
4 level Touch function



Akkubetrieb ·  
Rechargeable battery operated



USB Anschluss ·  
USB connection

Stehleuchte · Floor lamp  
incl. SMD-LED  
4,5 W / 350 Lumen  
3.000 Kelvin

**R42111131** Weiß matt · white mat  
**R42111166** Sand · sand



IP20

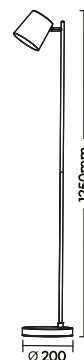

31

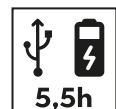

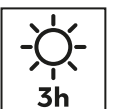

5,5h



3h

# JEFF

Metall · Metal

-  4 fach TOUCH ·  
4 level Touch function
-  Akkubetrieb ·  
Rechargeable battery operated
-  USB Anschluss ·  
USB connection

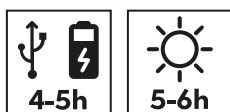
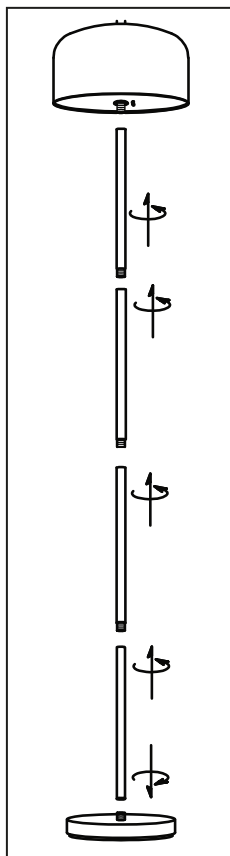
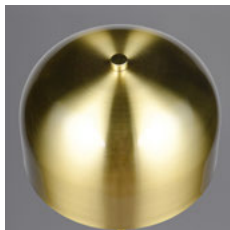

Stehleuchte · Floor lamp

incl. SMD-LED  
2,5 W / 250 Lumen  
3.000 Kelvin

- R49151107 Nickel matt · nickel mat
- R49151108 Messing matt · brass mat
- R49151131 Weiß matt · white mat
- R49151132 Schwarz matt · black mat
- R49151165 Coffee · coffee

 IP20

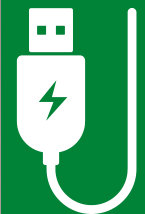
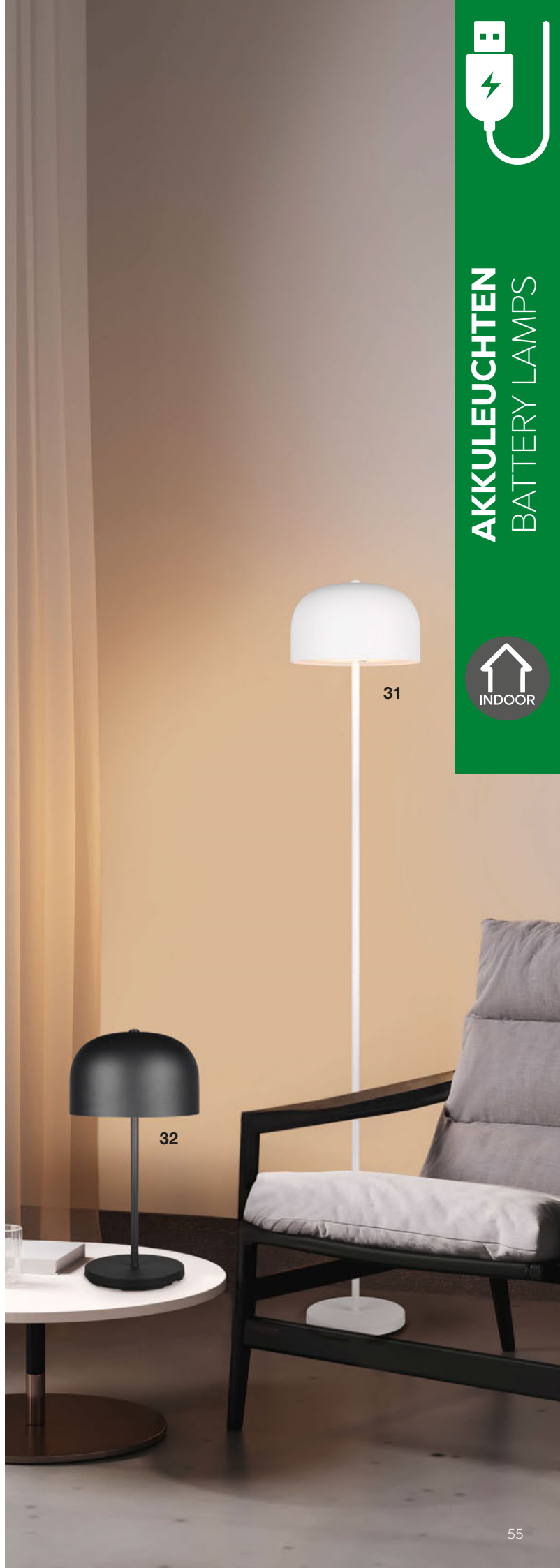
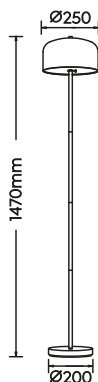



AKKULEUCHTEN  
BATTERY LAMPS



# RICARDO

Kunststoff · Plastic

-  4 fach TOUCH ·  
4 level Touch function
-  USB Anschluss ·  
USB connection
-  Akkubetrieb ·  
Rechargeable battery operated

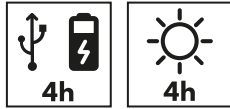
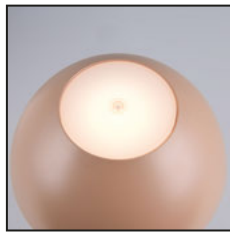

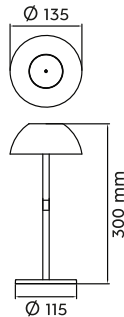

Tischleuchte · Table lamp  
incl. SMD-LED  
1,7 W / 240 Lumen  
3.000 Kelvin  
R54106165 Coffee · coffee



# FERNANDEZ

Kunststoff · Plastic

-  Lichtfarbe einstellbar ·  
Adjustable light color
-  Sensordimmer ·  
Sensor dimmer
-  Inklusive Ladestation ·  
Charging station included

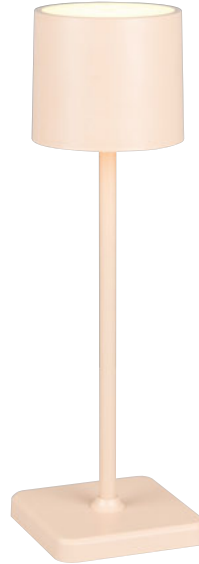
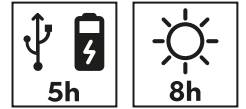

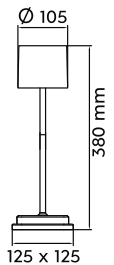

Tischleuchte · Table lamp  
incl. SMD-LED  
1,5 W / 130 Lumen  
2.700 + 4.000 + 6.000 Kelvin  
R54096166 Sand · sand



# SUAREZ

Metall · Metal

-  On/Off Touch Funktion ·  
On/Off Touch function
-  Sensordimmer ·  
Sensor dimmer
-  USB Anschluss ·  
USB connection

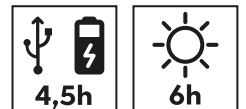

Stehleuchte · Floor lamp  
incl. SMD-LED  
1,5 W / 200 Lumen  
3.000 Kelvin  
R47706166 Sand · sand

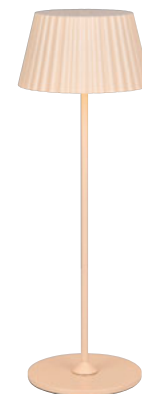

Tischleuchte · Table lamp  
incl. SMD-LED  
1,5 W / 200 Lumen  
3.000 Kelvin  
R57706166 Sand · sand

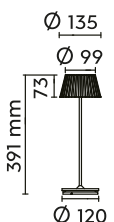



# DIAZ

Metall · Metal

 Lichtfarbe stufenlos einstellbar ·  
Light color infinitely variable

 4 fach TOUCH ·  
4 level Touch function

 USB Anschluss ·  
USB connection

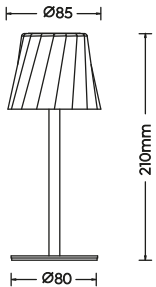
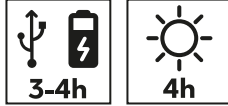
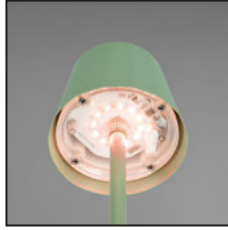

Tischleuchte · Table lamp

incl. SMD-LED  
1,6 W / 160 Lumen  
2.700 - 6.500 Kelvin

R55961131 Weiß matt · white mat  
R55961132 Schwarz matt · black mat  
R55961149 Pistaziengrün · pistachio green  
R55961166 Sand · sand  
R55961177 Ultimate Grau · ultimate grey



AKKULEUCHTEN  
BATTERY LAMPS



# ORTIZ

Kunststoff · Plastic

 On/Off Touch Funktion ·  
On/Off Touch function

 USB Anschluss ·  
USB connection

 Memory Funktion ·  
Memory function

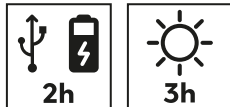
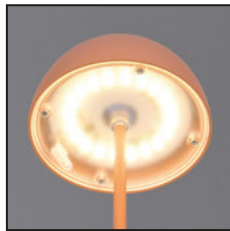
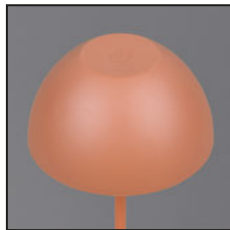
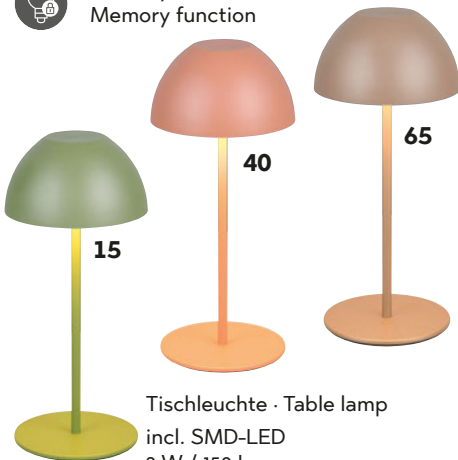

Tischleuchte · Table lamp

incl. SMD-LED  
2 W / 150 Lumen  
3.000 Kelvin

R55601115 Grün · green  
R55601131 Weiß matt · white mat  
R55601132 Schwarz matt · black mat  
R55601140 Apricot · apricot  
R55601165 Coffee · coffee

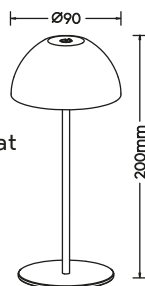







# OUTDOOR

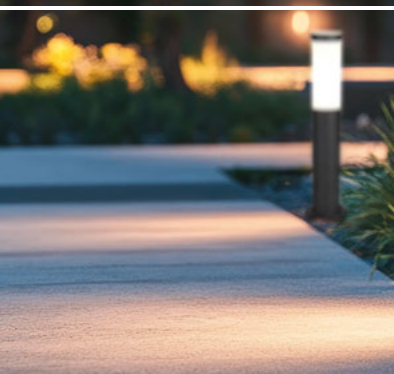
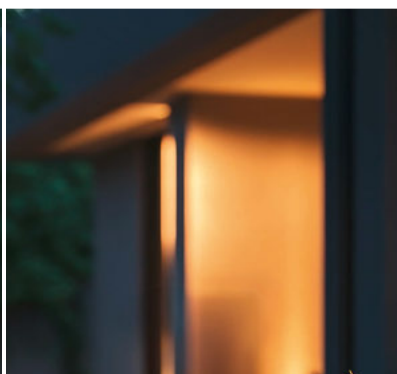
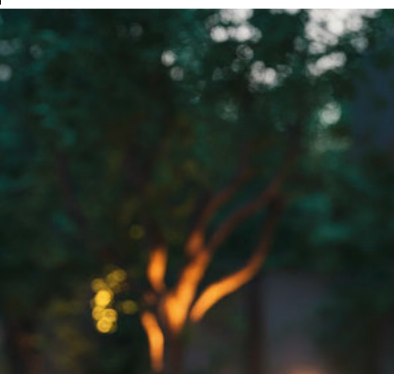

## Außenleuchten Outdoor luminaires





# TRIOTO

Edelstahl Schwarz matt, Kunststoff Weiß  
Steel black mat, plastic white



Wandleuchte · Wall lamp  
excl. 1 x E27  
max. 25 W  
209769132

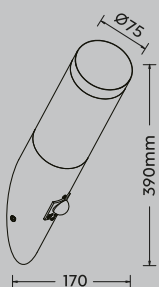

Wandleuchte · Wall lamp  
excl. 1 x E27  
max. 25 W  
209760132

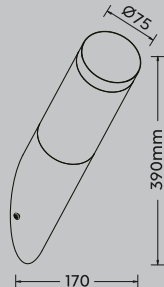

Sockelleuchte · Pedestal lamp  
excl. 1 x E27  
max. 25 W  
509760132

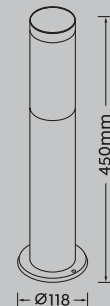



# MACKENZIE

Aluminium Druckguss Anthrazit, Kunststoff Weiß  
Diecast aluminium anthracite, plastic white

OUTDOOR



Wandleuchte · Wall lamp  
incl. SMD-LED  
8 W / 800 Lumen  
3.000 Kelvin  
**230561142**

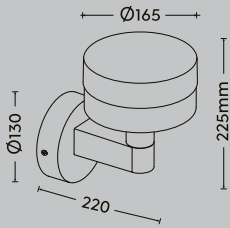

Wandleuchte · Wall lamp  
incl. SMD-LED  
8 W / 800 Lumen  
3.000 Kelvin  
**230569142**

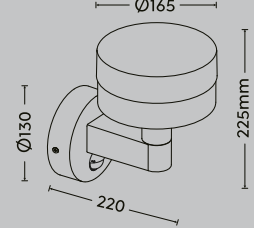

◀ Bodenleuchte · Floor lamp  
incl. SMD-LED  
8 W / 800 Lumen  
3.000 Kelvin  
**430561142**

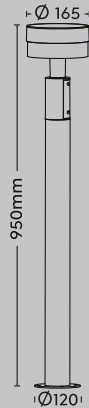

Sockelleuchte · Podestal lamp ▶  
incl. SMD-LED  
8 W / 800 Lumen  
3.000 Kelvin  
**530561142**

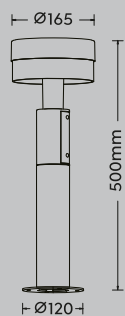



Wandleuchte · Wall lamp  
 excl. 1 x E27  
 max. 10 W  
**262569178**



 IP54



Wandleuchte · Wall lamp  
 excl. 1 x E27  
 max. 10 W  
**262560178**

 IP54



# FRASER

Aluminium Druckguss · Diecast aluminium

- 35** | Holznachbildung / Anthrazit · Wood imitation / anthracite
- 78** | Betonfarbig / Anthrazit · Concrete / anthracite



Bodenleuchte · Floor lamp  
 excl. 1 x E27  
 max. 10 W  
**462560178**

 IP54



Sockelleuchte · Pedestal lamp  
 excl. 1 x E27  
 max. 10 W  
**562560178**



 IP54

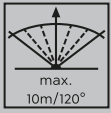
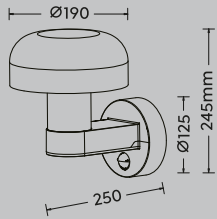

Wandleuchte · Wall lamp  
 excl. 1 x E27  
 max. 10 W  
**262569135**

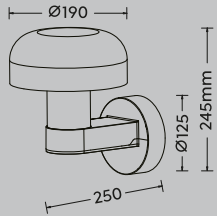

Wandleuchte · Wall lamp  
 excl. 1 x E27  
 max. 10 W  
**262560135**



◀ Bodenleuchte · Floor lamp  
 excl. 1 x E27  
 max. 10 W  
**462560135**



Sockelleuchte · Podestal lamp ▶  
 excl. 1 x E27  
 max. 10 W  
**562560135**

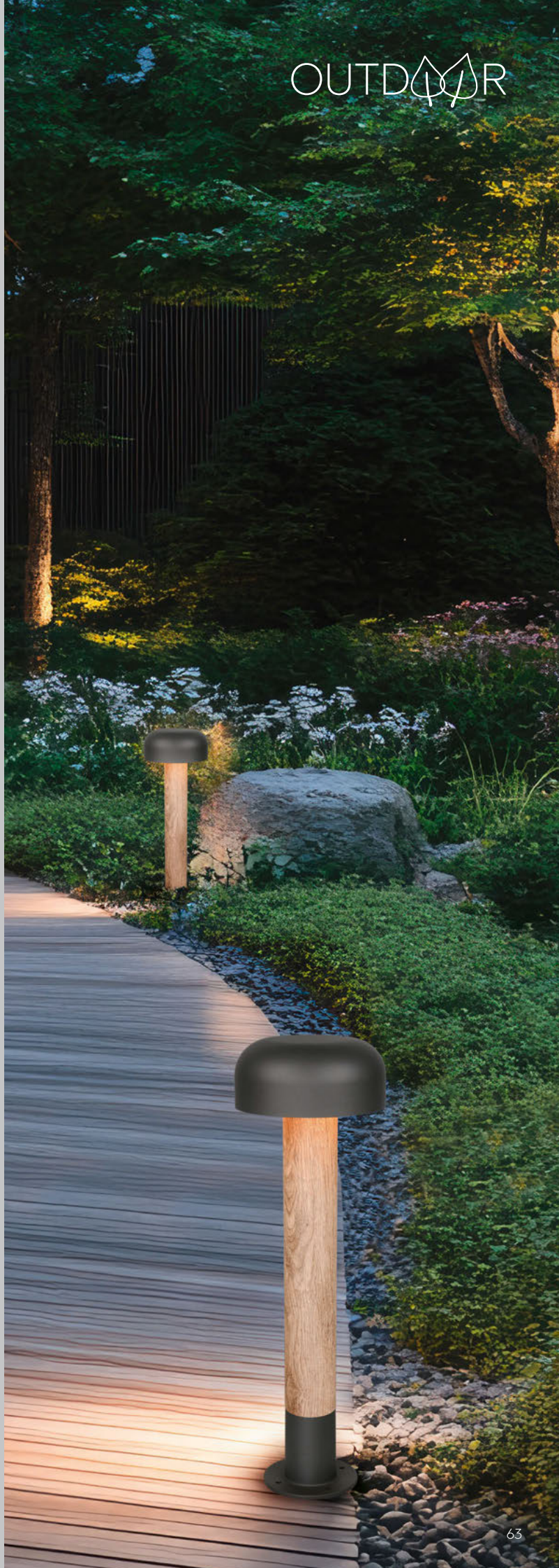
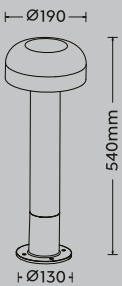



# MAAS

Aluminium Druckguss, Kunststoff  
Diecast aluminium, plastic



66



15

Wandleuchte · Wall lamp

excl. 1 x E27

max. 10 W

262460115 Grün · green

262460124 rostfarbig · rusty

262460140 Apricot · apricot

262460142 Anthrazit · anthracite

262460166 Sand · sand



40



24

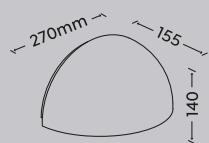

42







40



15



42

## ELBE

Aluminium Druckguss, Kunststoff  
Diecast aluminium, plastic

Wandleuchte · Wall lamp

excl. 1 x E27  
max. 10 W

- 262360115 Grün · green
- 262360124 rostfarbig · rusty
- 262360140 Apricot · apricot
- 262360142 Anthrazit · anthracite
- 262360166 Sand · sand



66



24

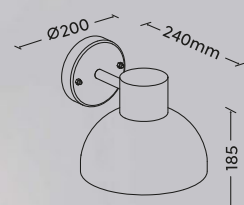





# MAYENNE

Aluminium Druckguss Weiß matt, Glas Weiß  
Diecast aluminium white mat, glass white



Wandleuchte · Wall lamp

excl. 2 x E14  
max. 10 W

**218560231**

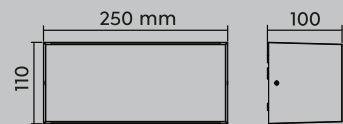

# GARONNE

Aluminium Druckguss Weiß matt,  
Glas Transparent

Diecast aluminium white mat,  
glass transparent

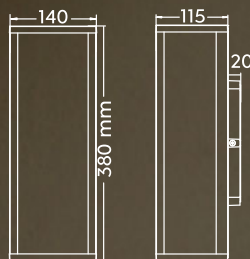
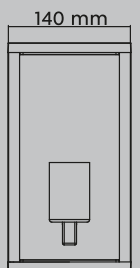

Wandleuchte · Wall lamp

excl. 2 x E27  
max. 10 W

**201860231**



Wandleuchte · Wall lamp

excl. 1 x E27  
max. 60 W

**201860131**

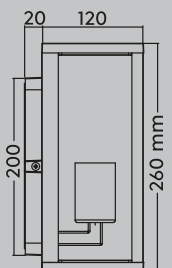





2.300 K



3.000 K



4.000 K

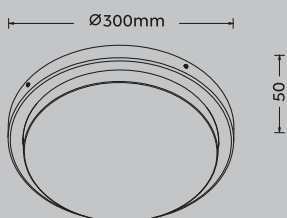
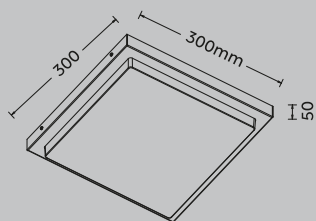

## BERMEJO

Metall Anthrazit, Kunststoff Weiß  
Metal anthracite, plastic white



Bewegungssensor ·  
Motion sensor



Lichtfarbe direkt an der Leuchte einstellbar ·  
Colours directly adjustable at the lamp

Deckenleuchte · Ceiling lamp

incl. SMD-LED  
14 W / 1.450 Lumen  
2.300 + 3.000 + 4.000 Kelvin  
**630369242**



Deckenleuchte · Ceiling lamp

incl. SMD-LED  
14 W / 1.450 Lumen  
2.300 + 3.000 + 4.000 Kelvin  
**630369142**



# MIRANDE

Aluminium Druckguss, Glas ·  
Diecast aluminium, glass



Wandleuchte · Wall lamp  
excl. 1 x E27  
max. 40 W

262260124 rostfarbig · rusty  
262260131 Weiß matt · white mat  
262260142 Anthrazit · anthracite

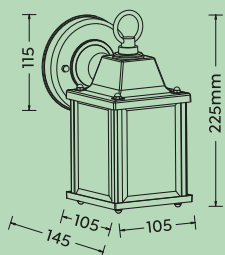

# SAMBESI

Aluminium Druckguss Anthrazit, Holznachbildung,  
Kunststoff transparent

Diecast aluminium anthracite, wood imitation,  
plastic transparent



Wandleuchte · Wall lamp  
excl. 1 x E27  
max. 28 W  
204169135

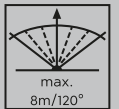
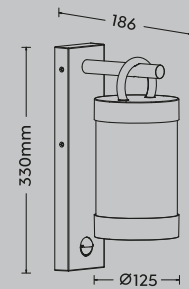

Wandleuchte · Wall lamp  
excl. 1 x E27  
max. 28 W  
204160135

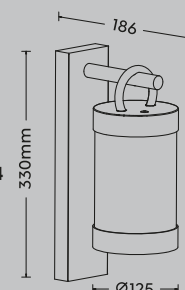



# SAMBESI

Aluminium Druckguss, Kunststoff transparent ·  
Diecast aluminium, plastic transparent



Dämmerungssensor ·  
Dusk sensor



Bodenleuchte · Floor lamp

excl. 3 x E27  
max. 28 W

404160324 rostfarbig · rusty

404160342 Anthrazit · anthracite



IP44



OUTDOOR





Sockelleuchte · Podestal lamp

excl. 1 x E27  
max. 10 W

563260131  
563260132

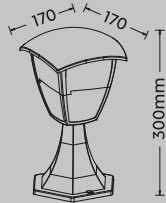

Pendelleuchte · Pendant

excl. 1 x E27  
max. 10 W

363260131  
363260132

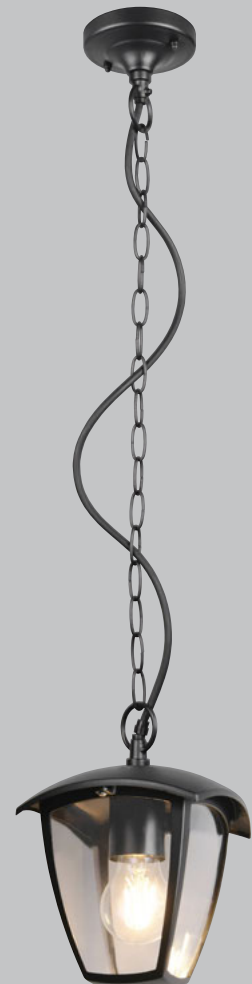
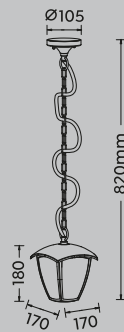





Wandleuchte · Wall lamp

excl. 1 x E27  
max. 10 W

263260331  
263260332

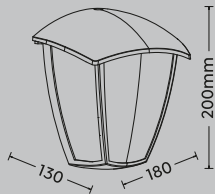

## VENTA

Aluminium Druckguss, Kunststoff ·  
Diecast aluminium, plastic

31 | Weiß matt · white matt

32 | Schwarz matt · black matt



Wandleuchte · Wall lamp

excl. 1 x E27  
max. 10 W

263260231  
263260232

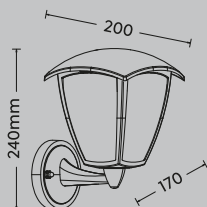

Wandleuchte · Wall lamp

excl. 1 x E27  
max. 10 W

263260131  
263260132

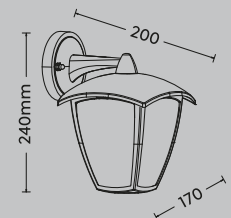



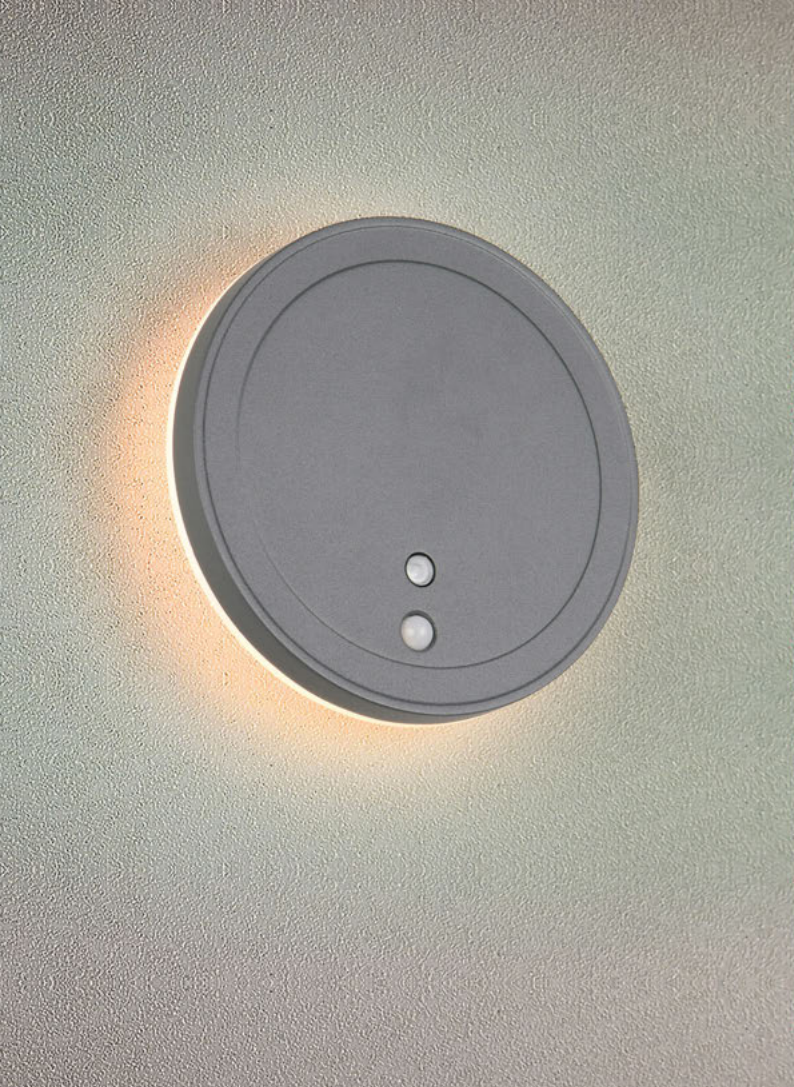







# FORTALEZA

Aluminium Druckguss Anthrazit, Kunststoff ·  
Diecast aluminium anthracite, plastic

-  Bewegungssensor ·  
Motion sensor
-  Dämmerungssensor ·  
Dusk sensor
-  indirekte Beleuchtung ·  
indirect lighting
-  Bewegungssensor und Orientierungslicht ·  
Motion sensor and orientation light

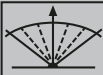
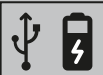
 **AKKUBETRIEB**  
RECHARGEABLE

-  max.  
4m/120°
-  4-5h
-  4-8h



Wandleuchte · Wall lamp  
incl. SMD-LED  
2 W / 200 Lumen  
3.000 Kelvin  
R23056142

Wandleuchte · Wall lamp  
incl. SMD-LED  
2 W / 200 Lumen  
3.000 Kelvin  
R23056242

-     IP54
-     IP54

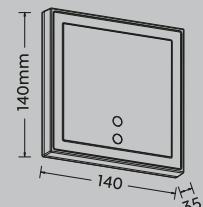
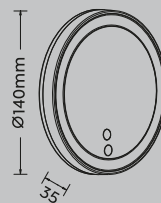





Wandleuchte · Wall lamp  
incl. SMD-LED  
12,5 W / 1.650 Lumen  
4.000 Kelvin  
**R23359142**

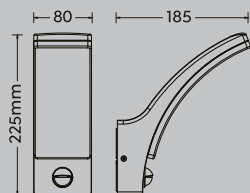

OUTDOOR

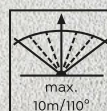

Wandleuchte · Wall lamp  
incl. SMD-LED  
12,5 W / 1.650 Lumen  
4.000 Kelvin  
**R23356142**

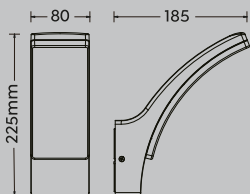

BEJA



Aluminium Druckguss Anthrazit, Kunststoff ·  
Diecast aluminium anthracite, plastic



Bodenleuchte · Floor lamp  
incl. SMD-LED  
12,5 W / 1.650 Lumen  
4.000 Kelvin  
**R43356142**



Sockelleuchte · Podestal lamp  
incl. SMD-LED  
12,5 W / 1.650 Lumen  
4.000 Kelvin  
**R53356142**

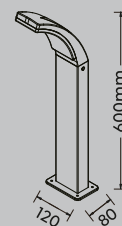

# BARCELOS

Aluminium Druckguss, Schwarz matt, Kunststoff  
Diecast aluminium, black mat, plastic



Wandleuchte · Wall lamp  
excl. 2 x GU10  
max. 10 W  
R26446232

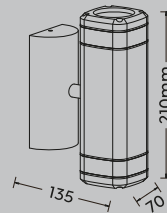

# ALMERIA

Aluminium Druckguss, Kunststoff Transparent  
Diecast aluminium, plastic transparent

Wandleuchte · Wall lamp  
excl. 1 x E27  
max. 28 W

R26476124 rostfarbig · rusty  
R26476142 Anthrazit · anthracite

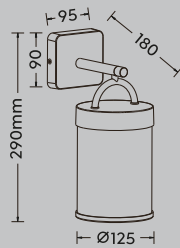

24



42

# SINTRA

Edelstahl Schwarz matt,  
Glas Weiß  
Steel black mat,  
glass white



Wandleuchte · Wall lamp  
excl. 1 x E27  
max. 25 W  
R26459132

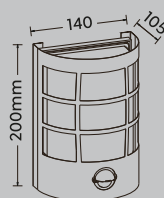
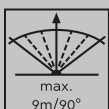

Wandleuchte · Wall lamp  
excl. 1 x E27  
max. 25 W  
R26456132

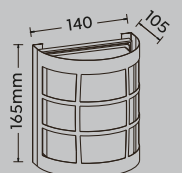





## FUNCHAL



Aluminium Druckguss Schwarz matt,  
Glas Transparent  
Diecast aluminium black mat,  
glass transparent

1) Wandleuchte · Wall lamp  
incl. SMD-LED  
30 W / 2.800 Lumen  
4.000 Kelvin  
R23349232

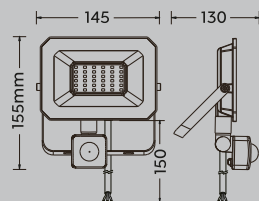

3) Wandleuchte · Wall lamp  
incl. SMD-LED  
30 W / 2.800 Lumen  
4.000 Kelvin  
R23346232

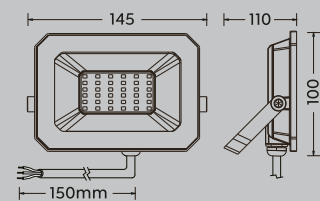

2) Wandleuchte · Wall lamp  
incl. SMD-LED  
20 W / 1.800 Lumen  
4.000 Kelvin  
R23349132

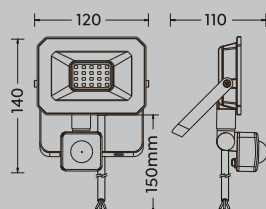

4) Wandleuchte · Wall lamp  
incl. SMD-LED  
20 W / 1.800 Lumen  
4.000 Kelvin  
R23346132

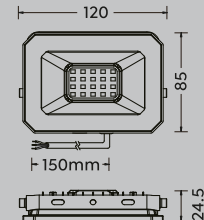

# HYBRID SOLAR

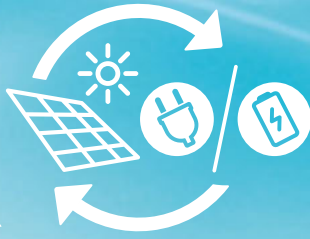

## Die innovative Kombination aus sauberer Solarenergie und Netz- oder Akkubetrieb

## The innovative combination of clean solar energy and mains or battery operation

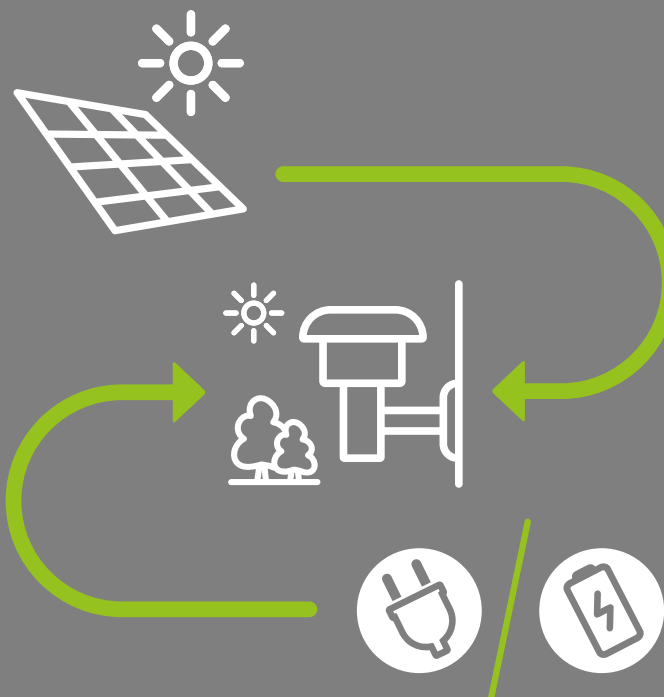

- ✓ 100% Stromkostensparnis während des Solar-Betriebs
- ✓ Sehr hohe Leuchtkraft
- ✓ Hocheffiziente Solarmodule
- ✓ Bewegungsmelder und Dämmerungssensoren sorgen für eine effiziente Nutzung des Solarstroms und mehr Sicherheit
- ✓ 100% electricity cost savings during solar operation
- ✓ Very high luminosity
- ✓ Highly efficient solar modules
- ✓ Motion detectors and twilight sensors ensure efficient use of solar power and more safety

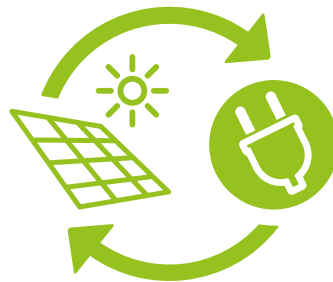

Hybride Solarleuchten tanken tagsüber Sonnenenergie und sorgen nachts für helles Licht. An trübem Tagen, wenn die Sonne mal nicht scheint und die Solarladung zur Neige geht, verbindet sich die Leuchte automatisch mit dem Stromnetz, um mit voller Kapazität weiterzuarbeiten.

Hybrid solar lights charge up with solar energy during the day and provide bright light at night. On cloudy days, when the sun is not shining and the solar charge is running low, the light automatically connects to the power grid to continue working at full capacity.

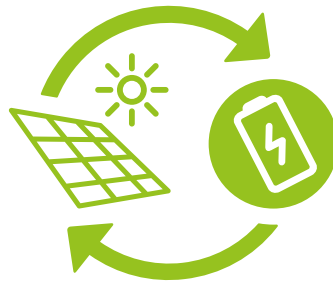

Bei schwacher Solarladung lässt sich die Leuchte in wenigen Stunden über die eingebaute USB-Funktion mühelos aufladen. Das garantiert konstante Lichtleistung und maximale Effizienz.

If the solar charge is low, the light can be easily recharged in just a few hours using the built-in USB function. This guarantees constant light output and maximum efficiency.



# OUTDOOR



## ◀ Wandleuchte · Wall lamp

incl. SMD-LED  
5,5 W / 650 Lumen  
4.000 Kelvin  
**R23286132**

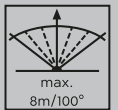
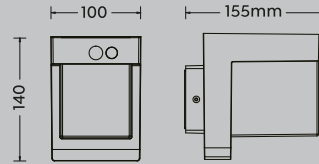

# COLOMBO



Metall Schwarz matt, Kunststoff  
Metal black mat, plastic

- Bewegungssensor · Motion sensor
- Dämmerungssensor · Dusk sensor
- Bewegungssensor und Orientierungslicht · Motion sensor and orientation light
- Solar · Solar

## Sockelleuchte · Pedestal lamp ▶

incl. SMD-LED  
5,5 W / 650 Lumen  
4.000 Kelvin  
**R53286132**

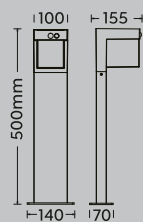

## ◀ Bodenleuchte · Floor lamp

incl. SMD-LED  
5,5 W / 650 Lumen  
4.000 Kelvin  
**R43286132**

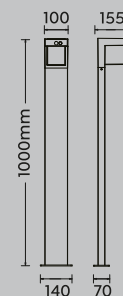

### 3 Beleuchtungsmodi · 3 lighting modes

Modus 1: Orientierungslicht 5%  
Mode 1: Orientation light 5%

Modus 2: 100% Helligkeit bei Bewegung,  
danach Orientierungslicht 5%  
Mode 2: 100% brightness on movement,  
then orientation light 5%

Modus 3: 100% Helligkeit bei Bewegung,  
danach aus

Mode 3: 100% brightness during movement,  
then off

# SILVES



Kunststoff · Plastic

- Bewegungssensor · Motion sensor
- Dämmerungssensor · Dusk sensor
- Bewegungssensor und Orientierungslicht · Motion sensor and orientation light
- Helligkeit einstellbar · Adjustable light level



02



01

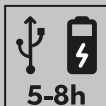

Wandleuchte · Wall lamp

incl. SMD-LED  
6 W / 700 Lumen  
4.000 Kelvin

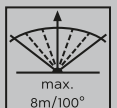

R23306101 Weiß · white  
R23306102 Schwarz · black

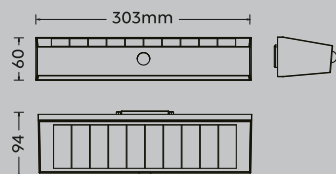

# BILBAO



Kunststoff · Plastic

- Bewegungssensor · Motion sensor
- Dämmerungssensor · Dusk sensor
- Bewegungssensor und Orientierungslicht · Motion sensor and orientation light
- Helligkeit einstellbar · Adjustable light level



01



02

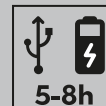

Wandleuchte · Wall lamp

incl. SMD-LED  
6 W / 700 Lumen  
4.000 Kelvin

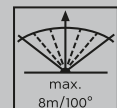

R23336201 Weiß · white  
R23336202 Schwarz · black

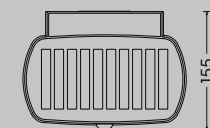
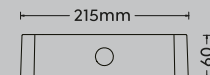

### 3 Beleuchtungsmodi · 3 lighting modes

Modus 1: 100% / 50% / 25% Helligkeit bei Bewegung, danach aus

Mode 1: 100% / 50% / 25% brightness on movement, then off

Modus 2: 100% / 50% / 25% Helligkeit bei Bewegung, danach Orientierungslicht 5%

Mode 2: 100% / 50% / 25% brightness on movement, then orientation light 5%

Modus 3: Orientierungslicht 5%

Mode 3: Orientation light 5%





# ALVORADA



Kunststoff Schwarz · Plastic black



Bewegungssensor · Motion sensor



Dämmerungssensor · Dusk sensor



Bewegungssensor und Orientierungslicht · Motion sensor and orientation light



Helligkeit einstellbar · Adjustable light level

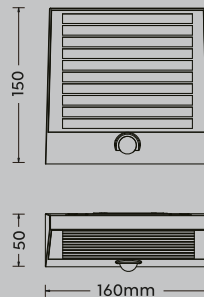
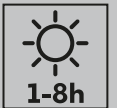
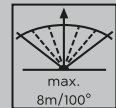
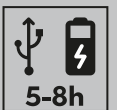

Wandleuchte · Wall lamp

incl. SMD-LED  
6 W / 600 Lumen  
4.000 Kelvin

R23326102



## 3 Beleuchtungsmodi · 3 lighting modes

Modus 1: 100% / 50% / 25% Helligkeit bei Bewegung, danach aus

Mode 1: 100% / 50% / 25% brightness on movement, then off

Modus 2: 100% / 50% / 25% Helligkeit bei Bewegung, danach Orientierungslicht 5%



Mode 2: 100% / 50% / 25% brightness on movement, then orientation light 5%

Modus 3: Orientierungslicht 5%

Mode 3: Orientation light 5%

# LAGOAS

Kunststoff Schwarz · Plastic black

-  Dämmerungssensor · Dusk sensor
-  Bewegungssensor und Orientierungslicht · Motion sensor and orientation light

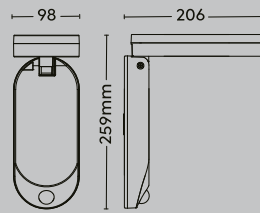
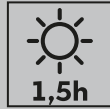
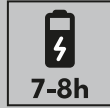
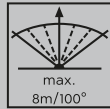

Wandleuchte · Wall lamp

incl. SMD-LED  
3 W / 350 Lumen  
4.000 Kelvin

R23176102



Modus: 100% Helligkeit bei Bewegung für 40 sek, danach Orientierungslicht 10%

Mode: 100% brightness on movement for 40 seconds, then orientation light 10%



# FESTIVAL

Kunststoff Schwarz matt · Plastic black mat

-  Dämmerungssensor · Dusk sensor
-  RGBW Farbwechsler · RGBW Colorchanging

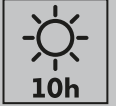
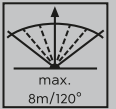

Strahler · Spot

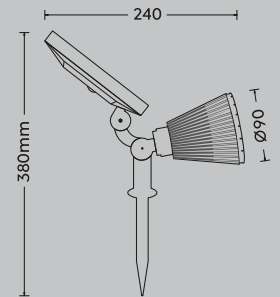

incl. SMD-LED  
1 W / 35 Lumen  
3.000 Kelvin

R84756232



# VIAMAO

Kunststoff Weiß · Plastic white

-  Dämmerungssensor · Dusk sensor
-  Bewegungssensor und Orientierungslicht · Motion sensor and orientation light

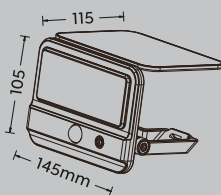
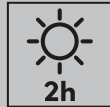
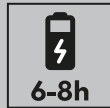
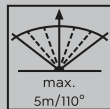

Wandleuchte · Wall lamp



incl. SMD-LED  
4 W / 400 Lumen  
4.000 Kelvin

R23166101



# OLINDA

Kunststoff Schwarz · Plastic black

-  Dämmerungssensor · Dusk sensor
-  Bewegungssensor und Orientierungslicht · Motion sensor and orientation light

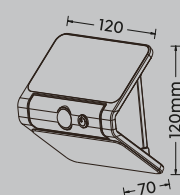
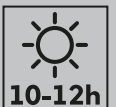
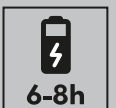
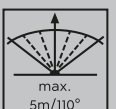

Wandleuchte · Wall lamp

incl. SMD-LED  
2,5 W / 250 Lumen  
4.000 Kelvin

R23156102



## 2 Beleuchtungsmodi · 2 lighting modes

Modus 1: 100% Helligkeit bei Bewegung, nach 20 sek ohne Bewegung aus

Mode 1: 100% brightness on movement, off after 20 seconds without movement

Modus 2: 100% Helligkeit bei Bewegung, nach 20 sek ohne Bewegung, für 1h Orientierungslicht mit 20%, danach aus

Mode 2: 100% brightness on movement, after 20 seconds without movement, for 1 hour orientation light with 20%, then off



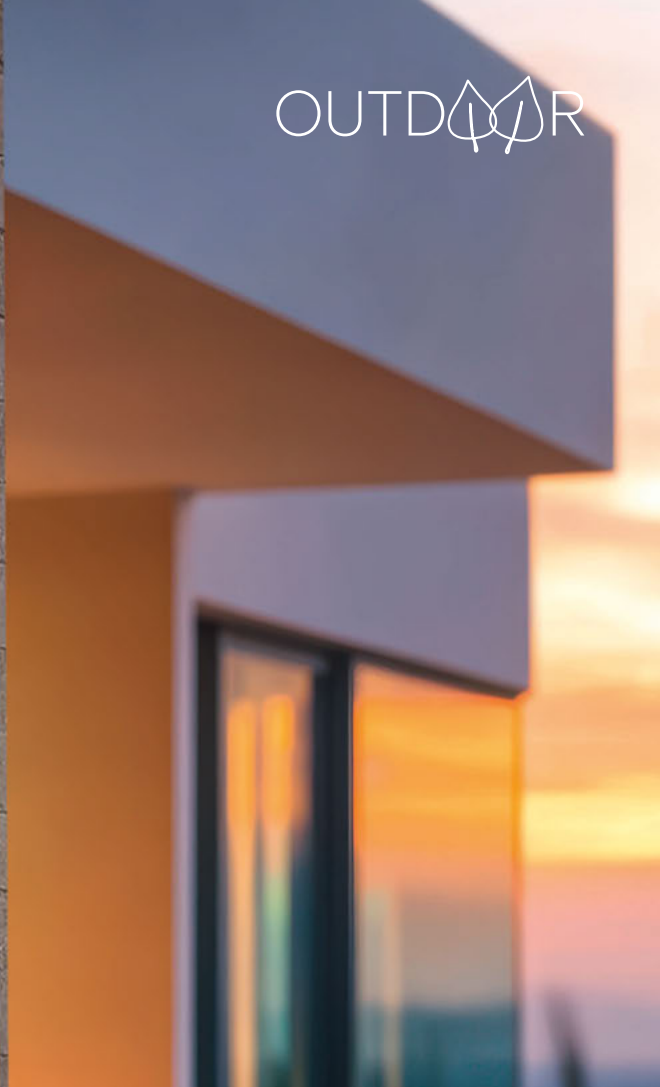

## MOURA



Aluminium Schwarz matt, Kunststoff, Glas ·  
Aluminium black mat, plastic, glass



Bewegungssensor ·  
Motion sensor



Lichtfarbe einstellbar ·  
Adjustable light color

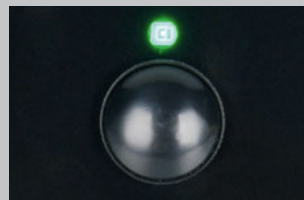
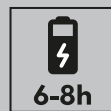
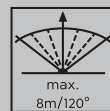

Wandleuchte · Wall lamp  
incl. SMD-LED  
10 W / 1.100 Lumen  
3.000 + 4.000 + 6.000 Kelvin  
R22109132

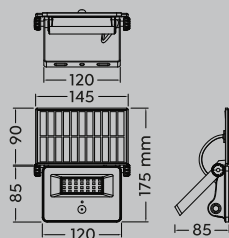

Wandleuchte · Wall lamp  
incl. SMD-LED  
18 W / 2.150 Lumen  
3.000 + 4.000 + 6.000 Kelvin  
R22106132

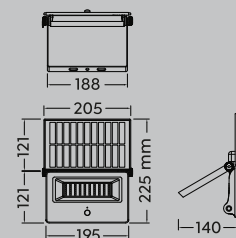

### 3 Beleuchtungsmodi · 3 lighting modes

Modus 1: Orientierungslicht 5%  
Mode 1: Orientation light 5%

Modus 2: 100% Helligkeit bei Bewegung,  
danach Orientierungslicht 5%

Mode 2: 100% brightness on movement,  
then orientation light 5%

Modus 3: 100% Helligkeit bei Bewegung,  
danach aus

Mode 3: 100% brightness during movement,  
then off

# MACAPA



Kunststoff Weiß · Plastic white

- Dämmerungssensor · Dusk sensor
- Bewegungssensor und Orientierungslicht · Motion sensor and orientation light

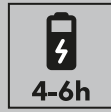
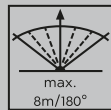

Wandleuchte · Wall lamp  
incl. SMD-LED  
5 W / 390 Lumen  
4.000 Kelvin  
**R23066101**

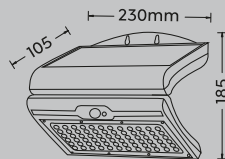

# DIADEMA



Kunststoff Weiß · Plastic white

- Dämmerungssensor · Dusk sensor
- Bewegungssensor und Orientierungslicht · Motion sensor and orientation light

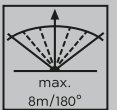

Wandleuchte · Wall lamp  
incl. SMD-LED  
3,5 W / 300 Lumen  
4.000 Kelvin  
**R23146101**

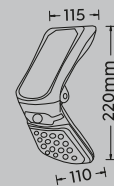

Modus: 100% Helligkeit bei Bewegung, nach 10 sek ohne Bewegung, Orientierungslicht 5%; Akku unter 30%: bei Bewegung auf 100% Helligkeit, nach 10 sek ohne Bewegung aus  
Mode: 100% brightness on movement, after 10 seconds without movement, orientation light 5%; battery below 30%: on movement to 100% brightness, after 10 seconds without movement off





# ACORA



Kunststoff Schwarz matt ·  
Plastic black mat



Bewegungssensor ·  
Motion sensor



Dämmerungssensor ·  
Dusk sensor

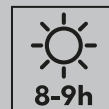
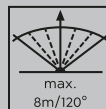

Wandleuchte · Wall lamp  
incl. SMD-LED  
18 W / 2.600 Lumen  
4.000 Kelvin  
**R22189132**

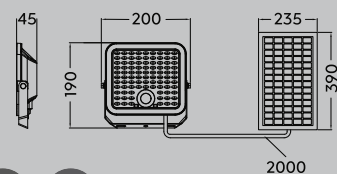

## 2 Beleuchtungsmodi · 2 lighting modes

Modus 1: Licht bei Dunkelheit (Helligkeit und Leuchtdauer über Timer einstellbar)  
Mode 1: Light in the dark (brightness and light duration adjustable via timer)

Modus 2: 100% Helligkeit bei Bewegung  
Mode 2: 100% brightness with movement





# OBIDOS



Aluminium Druckguss Schwarz matt  
Diecast aluminium black mat



Dämmerungssensor ·  
Dusk sensor



Helligkeit einstellbar ·  
Adjustable light level

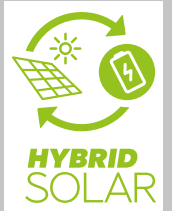

Solar-Leuchte · Solar light  
incl. SMD-LED  
3 x 0,5 W / 3 x 35 Lumen  
4.000 Kelvin  
R83256332

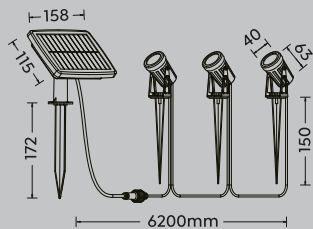

IP44

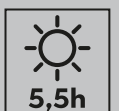
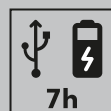
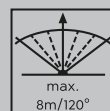







# MOOD

Kunststoff Schwarz  
Plastic black

-  Dämmerungssensor · Dusk sensor
-  Helligkeit einstellbar · Adjustable light level
-  Timer · Timer

**10flg.**  
**5,70 m**

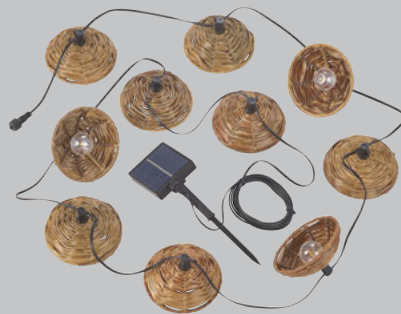

Lichterkette · Fairy lights  
incl. 10 x LED E12  
10 x 0,5 W / 10 x 30 Lumen  
2.700 Kelvin  
R74761932

- 
- 
- 
- 
- 
-  IP44

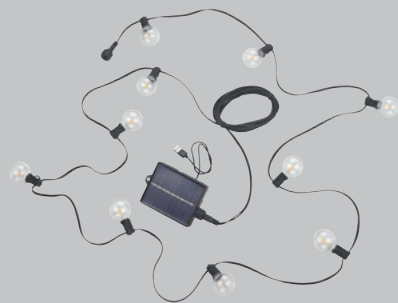
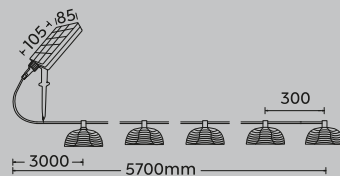

Lichterkette · Fairy lights  
incl. 10 x LED E12  
10 x 0,5 W / 10 x 30 Lumen  
2.700 Kelvin  
R74761132

- 
- 
- 
- 
- 
-  IP44

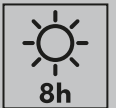
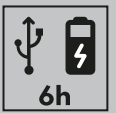
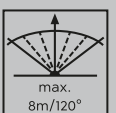
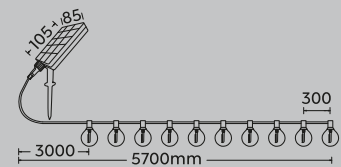



# CHAIN

Kunststoff Schwarz · Plastic black

**10flg.  
6,50 m**



Lichterkette · Fairy lights

incl. LED E27  
10 x 1 W / 10 x 80 Lumen  
3.000 Kelvin  
**R74771132**

⊕ IP44

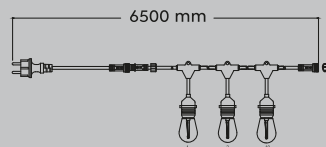

# CACERES

Kunststoff Schwarz · Plastic black



Strahler · Spot  
incl. LED E27  
15 W / 1.500 Lumen  
4.000 Kelvin  
**R86466102**

⊕ IP44

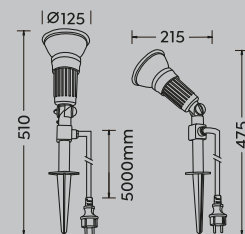





## CHAIN

Kunststoff Schwarz, Metall Schwarz matt ·  
Plastic black, metal black mat

**10flg.**  
**6,50 m**

Lichterkette · Fairy lights  
incl. LED E27  
10 x 1 W / 10 x 80 Lumen  
3.000 Kelvin  
R74771932

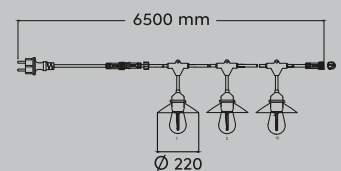

# Produkteigenschaften · Features

Caractéristiques · Kenmerken · Acabados ·  
Caratteristiche · Caracteristici · Ominaisuudet · Cechy



## Schalter · Switch

Interrupteur · Schakelaar · Interruptor · Interruttore ·  
Intrerupator · Kytkin · Przełącznik



## Fußschalter · Footswitch

Interrupteur à pédale · Voetschakelaar · Interruptor de pie ·  
Interruttore a pedale · Comutator picior · Päälle / pois jalkakytin ·  
Wyłłącznik nożny



## Schnurschalter · Cable switch

Interrupteur de cordon · Snoerschakelaar · Cable de interruptor ·  
Interruttore su cavo · Intrerupator cu cablu · katkaisin ja johto ·  
Przełącznik na kablu



## On/Off Touch Funktion · On/Off Touch function

Interrupteur tactile On/Off · Touch schakelaar On/Off ·  
Función táctil On/Off · Interruttore touch On/Off ·  
Intrerupator tactil On/Off · Kosketuskäyttöinen On/Off ·  
Funkcja dotykowa On/Off



## Getrennt schaltbar · Separately switchable

Interrupteurs séparés · Gescheiden schakelbaar ·  
Interrutores separados · Interruttori separati ·  
Intrerupatoare separate · Erikseen kytkettävissä ·  
Oddzieleny przełącznik



## Fernbedienung · Remote control

Commande à distance · Afstandsbediening · Mando a distancia ·  
Comando a distanza · Telecomanda · Kauko-ohjain · Pilot



## Integrierter Dimmer · Integrated dimmer

Variateur intégré · Geïntegreerde dimmer · Regulador integrado ·  
Dimmer integrato · Variator de lumina integrat · Integroitu  
himmennin · aWbudowany ściemniacz



## Sensordimmer · Sensor dimmer

Variateur tactile · Touchdimmer · Regulador con sensor ·  
Touchdimmer · Variator cu senzor · Kosketushimmennin ·  
Czujnik ściemniania



## RGB Farbwechsler · RGB Colorchanging

Changement de couleur RGB · RGB Kleurverandering ·  
Cambio de color RGB · Cambia colore RGB · Schimbator de  
culoare RGB · Värvvaihto RGB · Zmieniający kolor RGB



## Lichtfarbe einstellbar · Adjustable light color

Couleur de lumière réglable · Lichtkleur instelbaar · Color de luz  
regulable · Colore della luce regolabile · Lumina colorata  
reglabila · Värlämpötila säädettävissä · Regulowana barwa światła



## Bewegungssensor · Motion sensor

Détecteur de mouvement · Bewegungssensor · Sensor de  
movimiento · Sensore di movimento · Senzor de mișcare ·  
Liiketunnistin · Czujnik ruchu



## Dämmerungssensor · Dusk sensor

Détecteur de crépuscule · Schemeringsensor · Sensor de  
oscuridad · Sensore crepuscolare · Senzor de lumina/amurg ·  
Hämärätunnistin · Czujnik zmierzchowy



## Schwenkbar · Slewable

Pivotant · Draaibaar · Pivotante · Girevole · Pivotant ·  
Suunnattava · SkreŹny



## 4 fach TOUCH · 4 level Touch function

Interrupteur tactile 4 niveaux · Touch schakelaar 4 niveaus ·  
Función Táctil 4 nivel · Interruttore touch 4 livelli ·  
Intrerupator tactil 4 nivele · Kosketuskäyttöinen 4 taso ·  
Funkcja dotykowa 4 poziomy



## Flexibel · Flexible

Flexible · Flexibel · Flexible · Flessibile · Flexibil · Joustava ·  
Elastyczne



## Lichtfarbe stufenlos einstellbar ·

## Light color infinitely variable

Couleur de lumière infiniment variable · Lichtkleur traploos  
instelbaar · Color de luz infinitamente variable · Colore della luce  
infinitamente variabile · Culoare lumină infinit variabilă · Valon  
väri portaattomasti · Jasny kolor bezstopniowo



## USB Anschluss · USB connection

Entrée USB · USB aansluiting · Conexión USB · Connessione  
USB · Conexiune USB · USB-liitäntä · Połączenie USB



## Nachtlicht · Night light

Veilleuse de nuit · Nachtlucht · Luz de la noche · Luce notturna ·  
Lampă de noapte · Yyövalo · Lampka nocna



## Up and down Beleuchtung · Up and Down lighting

Point lumineux en haut et en bas · Lichtpunt boven en onder ·  
Luz de arriba y abajo · Luce su e giù · Sus și în jos lumina · Ylös  
ja alas valoa · W górę iw dół światło



## Dimmbar mit Schalter · Dimmable via switch

Réglable avec interrupteur · Dimbaar via schakelaar · Regulable  
mediante interruptor · Dimmerabile tramite interruttore ·  
Estompat prin comutator · Himmennettävä kytkimen ·  
Ściemnialne za pośrednictwem przełącznika



## Starlight Effekt · Starlight effect

Effet étoiles · Starlight effekt · Efecto estrella · Effetto stelle ·  
Effect de "stele" · Tähti efekti · Efekt starlight



## RGBW Farbwechsler · RGBW Colorchanging

Changement de couleur RGBW · RGBW Kleurverandering ·  
Cambio de color RGBW · Cambia colore RGBW · Schimbator de  
culoare RGBW · Värvvaihto RGB · Zmieniający kolor RGBW



## Helligkeit einstellbar · Adjustable light level

Niveau d'éclairage ajustable · Instelbaar lichtniveau · Nivel de luz  
ajustable · Livello di luce regolabile · Nivelul de lumina reglabil ·  
Säädettävä valo taso · Regulowana jasność światła



## Memory Funktion · Memory function

Fonction mémoire · Geheugen functie · Función de memoria ·  
Funzione memorizzazione · functia memorie · Muistitoiminto ·  
Funkcja pamięci



## LIFT ME

Innovative Höhenverstellung ohne Gegengewicht ·  
Innovative height adjustment without counterweight ·  
Nouveau! Réglage de la hauteur sans contrepoids · Innovatieve  
hoogteverstelling zonder contragewicht · Innovador sistema de  
ajuste de altura sin necesidad de contrapeso · Regolazione  
innovativa dell'altezza senza contrappeso · Ajustare inovativa a  
inaltimii fara contragreutate · Innovatiivinen korkeuden säätö  
ilman vastapainoa · Innowacyjna regulacja wysokości bez  
przeciwwagi



## Akkubetrieb · Rechargeable battery operated

Fonctionnement sur batteries rechargeable ·  
Oplaadbare accu · Bateria recargable · Batteria Ricaricabile ·  
Operabil prin baterie reincarcabila · Ladattava akku ·  
Akumulator zasilany baterijnie



## Ohne Leuchtmittel · Lamp(s) excluded

Sans ampoule(s) · Zonder lichtbron(nen) · Sin bombilla(s) ·  
Lampadina Esclusa · Fara bec (s) · Ilman polttimo (s) ·  
Bez żarówki (s)





**Kippbar · Tilttable**  
Inclinable · Kantelbaar · Basculante · Inclinabile · Basculant ·  
Kallistettava · Uchylny



**Indirekte Beleuchtung · Indirect lighting**  
Lumière indirecte · Indirecte belichting · Iluminación indirecta ·  
Illuminazione a scomparsa · Iluminat indirect ·  
Epäsuoja valaistus · Oświetlenie pośrednie



**Inkl. Zuleitungskabel · Incl. supply cable**  
Câble d'alimentation inclus · Incl. voedingskabel · Incl. cable de  
alimentación · Incl. cavo di alimentazione · Incl. cablu de  
alimentare · Sis. syöttökaapelin · W tym kabel zasilający



**Exkl. Zuleitungskabel · Excl. supply cable**  
Câble d'alimentation non compris · Excl. voedingskabel · Exkl.  
cable de alimentación · Senza cavo di alimentazione · Excl. cablu  
de alimentare · Ilman syöttökaapelia · Bez kabla zasilającego



**Bewegungssensor und Orientierungslicht ·**  
**Motion sensor and orientation light**  
Capteur de mouvement et lumière d'orientation · Bewegungssensor  
en oriëntatielicht · Lámpara con sensor de movimiento y de orient-  
ación · Sensore di movimento e luce di orientamento · Senzor de  
mişcare și lumină de orientare · Liiketunnistin ja suuntavallo ·  
Czujnik ruchu i światło orientacyjne



**USB-C Anschluss · USB-C connection**  
Entrée USB-C · USB-C-aansluiting · Conexión USB-C ·  
Connessione USB-C · Conexiune USB-C ·  
USB-C-liitäntä · Połączenie USB-C



**Inklusive Ladestation · Charging station included**  
Station de recharge incluse · Laadstation inbegrepen ·  
Estación de carga incluida · Stazione di ricarica inclusa ·  
Stație de încărcare inclusă · Latausasema sisältyy ·  
W zestawie stacja ładująca

## Farben & Materialien · Colours and materials

Couleurs et matériaux · Kleuren en materialen · Colores y materiales · Colori e materiali ·  
Culori si materiale · Värit ja materiaalit · Kolory i materiały

- |  |  |   |
|--|--|---|
| <p><b>01</b> Weiß · white<br/>blanc · wit · blanco · bianco · alb ·<br/>valkoinen · biały</p> <p><b>02</b> Schwarz · black<br/>noir · zwart · negro · nero · negru ·<br/>musta · czarny</p> <p><b>06</b> Chrom · chrome<br/>chrome · chroom · cromo · cromo · crom ·<br/>kromi · chrom</p> <p><b>07</b> Nickel matt · nickel mat<br/>nickel mat · nikkel mat · níquel mate ·<br/>nichel opaco · nichel mat · harjattu teräs ·<br/>nikiel mat</p> <p><b>08</b> Messing matt · brass mat<br/>laiton mat · messing mat · bronze mate ·<br/>ottone satinato · bronz mat · mattamessinki ·<br/>mosiądz mat</p> <p><b>09</b> aluminiumfarbig · aluminium colour<br/>couleur aluminium · aluminium kleurig ·<br/>aluminio pintado · alluminio · aluminium colorat ·<br/>alumiini · aluminium malowane</p> <p><b>12</b> Blau · blue<br/>bleu · blauw · azul · azzurro · gri ·<br/>sininen · niebieski</p> <p><b>13</b> Amber · amber<br/>ambre · amber · ámbar · ambra · amber ·<br/>meripihka · bursztynowy</p> <p><b>15</b> Grün · green<br/>vert · groen · verde · verde · verde ·<br/>vihreä · zielony</p> <p><b>24</b> rostfarbig · rusty<br/>rouille · roestkleur · óxido · ruggine ·<br/>ruginiu · rustiikki · miedź</p> <p><b>26</b> Braun · brown<br/>brun · bruin · marron · marrone · maro ·<br/>ruskea · brązowy</p> | <p><b>31</b> Weiß matt · white mat<br/>blanc mat · wit mat · estera blanca ·<br/>bianco opaco · alb mat · valkoinen matto ·<br/>biały mat</p> <p><b>32</b> Schwarz matt · black mat<br/>noir mat · mat zwart · estera negra ·<br/>nero opaco · negru mat · musta matto ·<br/>czarny mat</p> <p><b>35</b> Holznachbildung · wood imitation<br/>imitation bois · houtimitatie · imitación de<br/>madera · effetto legno · imitație de lemn ·<br/>puujäljitelmä · imitacja drewna</p> <p><b>36</b> naturbelassen · natural finish<br/>finition naturelle · natuurlijke afwerking ·<br/>acabado natural · finitura naturale ·<br/>finisaj natural · luonnollinen viimeistely ·<br/>naturalne wykończenie</p> <p><b>40</b> Apricot · apricot<br/>abricot · abrikoos · albaricoque · apricot ·<br/>caise · aprikoosi · morela</p> <p><b>42</b> Anthrazit · anthracite<br/>antracite · antraciet · antracita · antracite ·<br/>antracit · antrasiitti · antracyt</p> <p><b>43</b> Warm Beige · warm beige<br/>beige chaud · warm beige · beige cálido ·<br/>beige caldo · bej cald · lämmin beige ·<br/>ciepły beż</p> <p><b>49</b> Pistaziengrün · pistachio green<br/>vert pistache · pistachegroen · verde pistacho ·<br/>verde pistacchio · verde fistic ·<br/>pistaasin vihreä · zielony pistacjowy</p> <p><b>53</b> Transparent irisierend · transparent clear<br/>transparent claire · transparent helder ·<br/>transparente claro · transparente chiaro ·<br/>transparent clar · kirkas · przezroczysty</p> | <p><b>54</b> rauchfarbig · smoke<br/>fumé · rookkleur · humo · fume' · fumuriu ·<br/>savu · przydymiony</p> <p><b>64</b> bronzefarbig · bronze<br/>bronce · bronze · bronce · bronzo ·<br/>bronz · pronssi · brąz</p> <p><b>65</b> Coffee · coffee<br/>café · koffie · café · caffè · cafea ·<br/>antiikkiteräs · kawa</p> <p><b>66</b> Sand · sand<br/>zand · arena · sabbia · nisip · hiekka ·<br/>piaskowy · kum</p> <p><b>76</b> Warm Grau · warm grey<br/>gris chaud · warm grijs · gris cálido ·<br/>grigio caldo · gri cald · lämmin harmaa ·<br/>ciepły szary</p> <p><b>77</b> Ultimate Grau · ultimate grey<br/>gris ultimate · ultiem grijs · gris absoluto ·<br/>grigio assoluto · gri suprem · kultaa ·<br/>ciemnoszary</p> <p><b>78</b> betonfarbig · concrete look<br/>couleur beton · beton kleur · color concreto ·<br/>calcestruzzo · culoare beton · konkreettisia<br/>väri · konkretny kolor · beton rengi</p> <p><b>79</b> goldfarbig · gold<br/>or · goud · oro · oro · aur · kultaa · złota</p> <p><b>80</b> Schwarz-Gold · black-gold<br/>noir et or · zwart-goud · negro-oro · oro nero ·<br/>negru-auriu · musta-kulta · czarno złoty</p> <p><b>93</b> Pink · pink<br/>rose · pink · rosa · rosa · roz · pinkki ·<br/>różowy · pembe</p> |
|--|--|---|

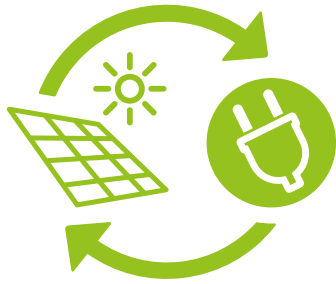

**DE**  
Hybrid solar lights charge up with solar energy during the day and provide bright light at night. On cloudy days, when the sun is not shining and the solar charge is running low, the light automatically connects to the power grid to continue working at full capacity.

**NL**  
Hybride solarlampen laden overdag op met zonne-energie en geven 's nachts helder licht. Op bewolkte dagen, als de zon niet schijnt en de zonnelading laag is, maakt de lamp automatisch verbinding met het elektriciteitsnet om op volle capaciteit te blijven werken.

**IT**  
Le lampade solari ibride si ricaricano con l'energia solare durante il giorno e forniscono una luce brillante di notte. Nelle giornate nuvolose, quando il sole non splende e la carica solare è bassa, la lampada si collega automaticamente alla rete elettrica per continuare a funzionare a pieno regime.

**FI**  
Hybridiaurinkolamput latautuvat aurinkoenergialla päivällä ja antavat loistavaa valoa yöllä. Pilvisenä päivänä, kun aurinko ei paista ja aurinkolataus on vähissä, lamppu kytkeytyy automaattisesti verkkoon jatkaakseen toimintaansa täydellä teholla.

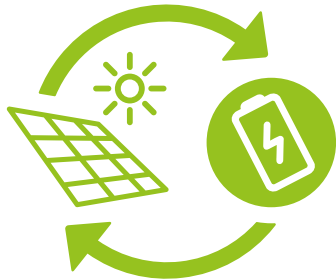

**DE**  
If the solar charge is low, the light can be easily recharged in just a few hours using the built-in USB function. This guarantees constant light output and maximum efficiency.

**NL**  
Als de zonne-energie bijna leeg is, kan de lamp eenvoudig in een paar uur worden opgeladen met de ingebouwde USB-functie. Dit garandeert een constante lichtopbrengst en maximale efficiëntie.

**IT**  
Se la carica solare è bassa, la luce può essere facilmente ricaricata in poche ore utilizzando la funzione USB integrata. Questo garantisce un'emissione luminosa costante e la massima efficienza.

**FI**  
Jos aurinkolataus on vähissä, valo voidaan ladata helposti muutamassa tunnissa sisäänrakennetun USB-toiminnon avulla. Tämä takaa tasaisen valotehon ja maksimaalisen tehokkuuden.

**DE**  
Hybride Solarleuchten tanken tagsüber Sonnenenergie und sorgen nachts für helles Licht. An trüben Tagen, wenn die Sonne mal nicht scheint und die Solarladung zur Neige geht, verbindet sich die Leuchte automatisch mit dem Stromnetz, um mit voller Kapazität weiterzuarbeiten.

**FR**  
Les lampes solaires hybrides se rechargent à l'énergie solaire pendant la journée et fournissent une lumière brillante la nuit. Par temps nuageux, lorsque le soleil ne brille pas et que la charge solaire est faible, la lampe se connecte automatiquement au réseau électrique pour continuer à fonctionner à pleine capacité.

**ES**  
Las lámparas solares híbridas se recargan con energía solar durante el día y proporcionan una luz brillante por la noche. En los días nublados, cuando el sol no brilla y la carga solar es baja, la lámpara se conecta automáticamente a la red para seguir funcionando a pleno rendimiento.

**RO**  
Lămpile solare hibride se reîncarcă cu energie solară în timpul zilei și oferă lumină strălucitoare noaptea. În zilele înnorate, când soarele nu strălucește și încărcarea solară este scăzută, lampa se conectează automat la rețea pentru a continua să funcționeze la capacitate maximă.

**PL**  
Hybrydowe lampy solarne ładują się energią słoneczną w ciągu dnia i zapewniają doskonałe światło w nocy. W pochmurne dni, gdy słońce nie świeci, a poziom naładowania jest niski, lampa automatycznie łączy się z siecią, aby kontynuować pracę z pełną wydajnością.

**DE**  
Bei schwacher Solarladung lässt sich die Leuchte in wenigen Stunden über die eingebaute USB-Funktion mühelos aufladen. Das garantiert konstante Lichtleistung und maximale Effizienz.

**FR**  
Si la charge solaire est faible, la lampe peut être facilement rechargée en quelques heures grâce à la fonction USB intégrée. Cela garantit une luminosité constante et une efficacité maximale.

**ES**  
Si la carga solar es baja, la luz puede recargarse fácilmente en unas pocas horas mediante la función USB incorporada. Esto garantiza una potencia luminosa constante y la máxima eficiencia.

**RO**  
Dacă încărcarea solară este scăzută, lumina poate fi ușor reîncărcată în doar câteva ore utilizând funcția USB încorporată. Acest lucru garantează o ieșire constantă a luminii și o eficiență maximă.

**PL**  
Jeśli poziom naładowania baterii słonecznej jest niski, lampę można łatwo naładować w ciągu zaledwie kilku godzin za pomocą wbudowanej funkcji USB. Gwarantuje to stały strumień światła i maksymalną wydajność.



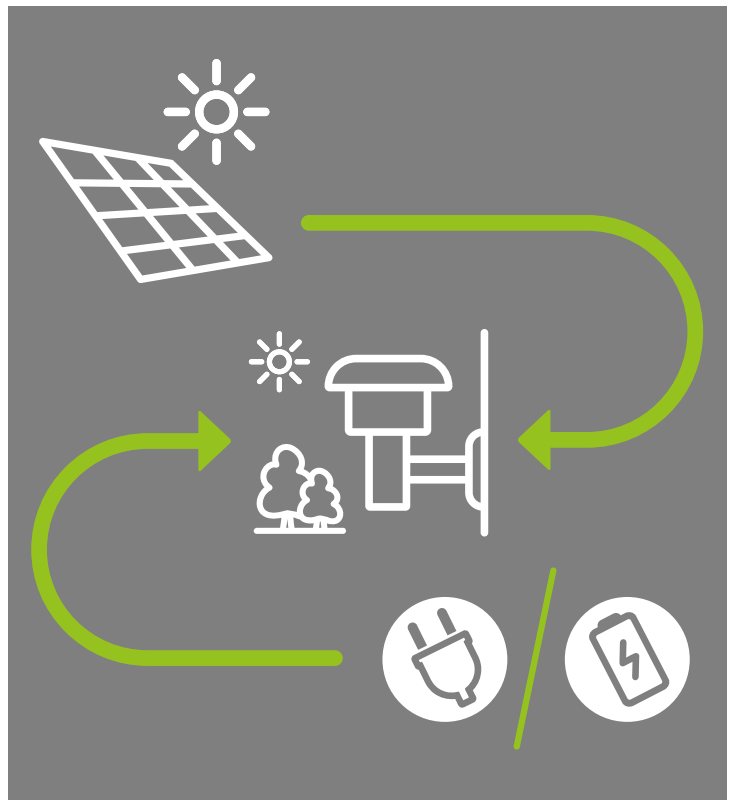

- Ⓓ
- ✓ 100% Stromkostensparnis während des Solar-Betriebs
  - ✓ Sehr hohe Leuchtkraft
  - ✓ Hocheffiziente Solarmodule
  - ✓ Bewegungsmelder und Dämmerungssensoren sorgen für eine effiziente Nutzung des Solarstroms und mehr Sicherheit

- Ⓔ
- ✓ 100% electricity cost savings during solar operation
  - ✓ Very high luminosity
  - ✓ Highly efficient solar modules
  - ✓ Motion detectors and twilight sensors ensure efficient use of solar power and more safety

- Ⓗ
- ✓ 100% besparing op elektriciteitskosten tijdens gebruik op zonne-energie
  - ✓ Zeer hoge lichtsterkte
  - ✓ Zeer efficiënte zonnepanelen
  - ✓ Bewegingsdetectoren en schemersensoren zorgen voor efficiënt gebruik van zonne-energie en meer veiligheid

- Ⓘ
- ✓ 100% di risparmio sui costi dell'elettricità durante il funzionamento solare
  - ✓ Luminosità molto elevata
  - ✓ Moduli solari ad alta efficienza
  - ✓ I rilevatori di movimento e i sensori crepuscolari garantiscono un uso efficiente dell'energia solare e una maggiore sicurezza.

- Ⓙ
- ✓ 100 % sähkökustannusten säästö aurinkokäytön aikana
  - ✓ Erittäin suuri valovoima
  - ✓ Erittäin tehokkaat aurinkopaneelit
  - ✓ Liiketunnistimet ja hämärätunnistimet varmistavat aurinkoenergian tehokkaan käytön ja turvallisuuden lisääntymisen.

- Ⓕ
- ✓ 100 % d'économies d'électricité pendant le fonctionnement de l'énergie solaire
  - ✓ Très grande luminosité
  - ✓ Modules solaires à haut rendement
  - ✓ Les détecteurs de mouvement et les capteurs crépusculaires garantissent une utilisation efficace de l'énergie solaire et une plus grande sécurité.

- Ⓖ
- ✓ 100% de ahorro en costes de electricidad durante el funcionamiento solar
  - ✓ Luminosidad muy elevada
  - ✓ Módulos solares de alta eficiencia
  - ✓ Los detectores de movimiento y los sensores crepusculares garantizan un uso eficiente de la energía solar y más seguridad

- Ⓡ
- ✓ Economii de energie electrică de 100% în timpul funcționării solare
  - ✓ Luminozitate foarte mare
  - ✓ Module solare extrem de eficiente
  - ✓ Detectoarele de mișcare și senzorii crepusculari asigură utilizarea eficientă a energiei solare și mai multă siguranță

- Ⓛ
- ✓ 100% oszczędności kosztów energii elektrycznej podczas pracy w trybie solarnym
  - ✓ Bardzo wysoka jasność
  - ✓ Wysokowydajne moduły słoneczne
  - ✓ Czujniki ruchu i zmierzchu zapewniają efektywne wykorzystanie energii słonecznej i większe bezpieczeństwo

Artikel-Nr. product no.	Serie series	Seite page	EAN-Nummer EAN-number	Artikel-Nr. product no.	Serie series	Seite page	EAN-Nummer EAN-number
201860131	GARONNE	66	4017807647525	814530307	GILLAN	7	4017807640489
201860231	GARONNE	66	4017807647549	814530365	GILLAN	7	4017807640441
204160135	SAMBESI	68	4017807647587	814570107	GILLAN	7	4017807641134
204169135	SAMBESI	68	4017807647600	814570165	GILLAN	7	4017807641127
209760132	TRIOTO	60	4017807648201	R20071026	SATNA	26	4017807636192
209769132	TRIOTO	60	4017807648218	R20101026	BINA	27	4017807636215
218560231	MAYENNE	66	4017807647563	R21681736	HIVE	18	4017807637212
230561142	MACKENZIE	61	4017807648522	R21851736	AIMEE	24	4017807637328
230569142	MACKENZIE	61	4017807648539	R21861736	ALICE	26	4017807637366
262260124	MIRANDE	68	4017807648287	R21871736	LEONIE	27	4017807637373
262260131	MIRANDE	68	4017807648294	R22106132	MOURA	81	4017807650488
262260142	MIRANDE	68	4017807648270	R22109132	MOURA	81	4017807650495
262360115	ELBE	65	4017807648454	R22189132	ACORA	83	4017807650563
262360124	ELBE	65	4017807648430	R23056142	FORTALEZA	72	4017807647907
262360140	ELBE	65	4017807648461	R23056242	FORTALEZA	72	4017807647914
262360142	ELBE	65	4017807648423	R23066101	MACAPA	82	4017807647921
262360166	ELBE	65	4017807648447	R23146101	DIADEMA	82	4017807647938
262460115	MAAS	64	4017807648508	R23156102	OLINDA	80	4017807647945
262460124	MAAS	64	4017807648485	R23166101	VIAMAO	80	4017807647952
262460140	MAAS	64	4017807648515	R23176102	LAGOAS	80	4017807647969
262460142	MAAS	64	4017807648478	R23286132	COLOMBO	77	4017807647983
262460166	MAAS	64	4017807648492	R23306101	SILVES	78	4017807648027
262560135	FRASER	62	4017807648560	R23306102	SILVES	78	4017807648010
262560178	FRASER	62	4017807650235	R23326102	ALVORADA	79	4017807648034
262569135	FRASER	62	4017807648577	R23336201	BILBAO	78	4017807648041
262569178	FRASER	62	4017807650242	R23336202	BILBAO	78	4017807648058
263260131	VENTA	70	4017807648119	R23346132	FUNCHAL	75	4017807648065
263260132	VENTA	70	4017807648102	R23346232	FUNCHAL	75	4017807648072
263260231	VENTA	70	4017807648133	R23349132	FUNCHAL	75	4017807648089
263260232	VENTA	70	4017807648126	R23349232	FUNCHAL	75	4017807648096
263260331	VENTA	70	4017807648195	R23356142	BEJA	73	4017807648386
263260332	VENTA	70	4017807648188	R23359142	BEJA	73	4017807648393
346710107	EMERSON	4	4017807642773	R24431115	DAVEY	51	4017807643824
346710176	EMERSON	4	4017807642803	R24431131	DAVEY	51	4017807643800
346710180	EMERSON	4	4017807642841	R24431132	DAVEY	51	4017807643794
353010107	GRAHAM	5	4017807642926	R24431140	DAVEY	51	4017807643831
353010132	GRAHAM	5	4017807642919	R24431143	DAVEY	51	4017807643817
363260131	VENTA	70	4017807648171	R24631101	UMBRIA	42	4017807640182
363260132	VENTA	70	4017807648164	R25791731	GINKO	36	4017807642469
404160324	SAMBESI	69	4017807648317	R25791732	GINKO	36	4017807642445
404160342	SAMBESI	69	4017807648300	R25791766	GINKO	36	4017807642452
412400165	MARLEY	9	4017807633993	R25831101	PONGO	46	4017807642766
416900306	PAXTON	2	4017807641219	R25831102	PONGO	46	4017807642797
416900380	PAXTON	2	4017807641233	R25831115	PONGO	46	4017807642810
430561142	MACKENZIE	61	4017807648553	R25831143	PONGO	46	4017807642834
462560135	FRASER	62	4017807648591	R25991126	LIRA	54	4017807643183
462560178	FRASER	62	4017807650266	R26091732	LAURENT	22	4017807637588
478310232	CHRIS	8	4017807642964	R26446232	BARCELOS	74	4017807648232
478310265	CHRIS	8	4017807642971	R26456132	SINTRA	74	4017807648249
506200165	NOLA	9	4017807633924	R26459132	SINTRA	74	4017807648256
506290165	NOLA	9	4017807633948	R26476124	ALMERIA	74	4017807648331
509760132	TRIOTO	60	4017807648225	R26476142	ALMERIA	74	4017807648324
512400165	MARLEY	9	4017807634013	R27771101	EARL	50	4017807643442
516900106	PAXTON	2	4017807641240	R27771113	EARL	50	4017807643435
516900180	PAXTON	2	4017807641288	R27771115	EARL	50	4017807643459
530561142	MACKENZIE	61	4017807648546	R27771154	EARL	50	4017807643404
562560135	FRASER	62	4017807648584	R31681036	HIVE	18	4017807637199
562560178	FRASER	62	4017807650259	R31681936	HIVE	18	4017807637205
563260131	VENTA	70	4017807648157	R31731026	JOELINE	16	4017807637250
563260132	VENTA	70	4017807648140	R31731926	JOELINE	16	4017807637267
564210113	FACETTE	50	4017807643541	R31831026	BIJOU	15	4017807637304
564210115	FACETTE	50	4017807643565	R31833026	BIJOU	15	4017807637298
564210154	FACETTE	50	4017807643589	R31881036	VALERIE	12	4017807637380
630369142	BERMEJO	67	4017807648348	R31941036	AMELIE	28	4017807637458
630369242	BERMEJO	67	4017807648355	R31971001	MADÉLINE	30	4017807637465
647810407	ROGER	6	4017807640052	R31971901	MADÉLINE	30	4017807638226
647810432	ROGER	6	4017807640106	R35791131	GINKO	36	4017807642438
647810465	ROGER	6	4017807640113	R35791132	GINKO	36	4017807642414
814500207	GILLAN	7	4017807640472	R35791166	GINKO	36	4017807642421
814500265	GILLAN	7	4017807640434	R36091032	LAURENT	22	4017807637601
814500407	GILLAN	7	4017807640496	R36111026	LUCILLE	14	4017807637618
814500465	GILLAN	7	4017807640458	R36141026	PAULETTE	28	4017807637533



Artikel-Nr. product no.	Serie series	Seite page	EAN-Nummer EAN-number	Artikel-Nr. product no.	Serie series	Seite page	EAN-Nummer EAN-number
R36161026	LAURINE	12	4017807637625	R56091032	LAURENT	22	4017807637571
R36161926	LAURINE	12	4017807637632	R56091932	LAURENT	22	4017807637595
R36191036	ROSALIE	14	4017807637649	R56221036	JEAN	17	4017807637687
R36211032	SANDRINE	20	4017807637656	R56231032	JEROME	21	4017807637724
R36221036	JEAN	17	4017807637670	R57706166	SUAREZ	56	4017807643244
R36241001	JANINE	30	4017807637663	R57971112	HOPPER	49	4017807643268
R36291032	FLEURE	29	4017807637731	R57971115	HOPPER	49	4017807643275
R36304064	JASON	38	4017807641172	R57971193	HOPPER	49	4017807643251
R36304079	JASON	38	4017807641165	R57991112	CUTIE	49	4017807643329
R40063132	GERRY	39	4017807618136	R57991115	CUTIE	49	4017807643343
R41571031	BIDAR	44	4017807633368	R57991193	CUTIE	49	4017807643299
R41571065	BIDAR	44	4017807633375	R61573331	BIDAR	44	4017807633405
R41571080	BIDAR	44	4017807629972	R61573365	BIDAR	44	4017807633429
R41681036	HIVE	18	4017807637243	R61573380	BIDAR	44	4017807629996
R42111131	BLAKE	54	4017807643367	R61681036	HIVE	18	4017807637236
R42111166	BLAKE	54	4017807643282	R61971001	MADELINE	30	4017807638240
R43286132	COLOMBO	77	4017807648003	R61971901	MADELINE	30	4017807638257
R43356142	BEJA	73	4017807648409	R64601131	SIRIUS	42	4017807638585
R45741107	PALERMO	39	4017807641370	R64631101	UMBRIA	42	4017807640229
R45741132	PALERMO	39	4017807641363	R64631901	UMBRIA	42	4017807640236
R45791131	GINKO	36	4017807642667	R64791101	ATARIS	42	4017807640519
R45791132	GINKO	36	4017807642629	R64801131	WHEELER	40	4017807640540
R45791166	GINKO	36	4017807642636	R64801132	WHEELER	40	4017807640564
R45831101	PONGO	46	4017807642759	R64801931	WHEELER	40	4017807640571
R45831102	PONGO	46	4017807642865	R64801932	WHEELER	40	4017807640588
R45831115	PONGO	46	4017807642872	R64811101	VARDA	43	4017807640601
R45831143	PONGO	46	4017807643138	R64811102	VARDA	43	4017807640625
R47706166	SUAREZ	56	4017807643220	R64821106	LUMOS	43	4017807640748
R49151107	JEFF	55	4017807640922	R64821109	LUMOS	43	4017807641011
R49151108	JEFF	55	4017807640939	R65791131	GINKO	36	4017807642582
R49151131	JEFF	55	4017807640885	R65791132	GINKO	36	4017807642520
R49151132	JEFF	55	4017807640892	R65791166	GINKO	36	4017807642544
R49151165	JEFF	55	4017807640915	R74761132	MOOD	85	4017807622607
R51681036	HIVE	18	4017807637229	R74761932	MOOD	85	4017807650693
R51851036	AIMEE	24	4017807637311	R74771132	CHAIN	86	4017807622720
R51971001	MADELINE	30	4017807638233	R74771932	CHAIN	87	4017807650648
R52801002	TACO	48	4017807641332	R81571731	BIDAR	44	4017807640632
R53286132	COLOMBO	77	4017807647990	R81571765	BIDAR	44	4017807640656
R53356142	BEJA	73	4017807648416	R81571780	BIDAR	44	4017807640649
R54096166	FERNANDEZ	56	4017807642476	R81572031	BIDAR	44	4017807640663
R54106165	RICARDO	56	4017807633900	R81572065	BIDAR	44	4017807640687
R54891115	MUNOZ	52	4017807640861	R81572080	BIDAR	44	4017807640670
R54891131	MUNOZ	52	4017807640847	R81574031	BIDAR	44	4017807640694
R54891132	MUNOZ	52	4017807640830	R81574065	BIDAR	44	4017807640717
R54891165	MUNOZ	52	4017807642537	R81574080	BIDAR	44	4017807640700
R54981113	DOOLEY	52	4017807643213	R81851736	AIMEE	24	4017807637335
R54981131	DOOLEY	52	4017807643121	R81852036	AIMEE	24	4017807637342
R54981153	DOOLEY	52	4017807643237	R81854036	AIMEE	24	4017807637359
R54981154	DOOLEY	52	4017807643206	R81921731	VALENTIN	32	4017807637403
R55601115	ORTIZ	57	4017807643350	R81921732	VALENTIN	32	4017807637397
R55601131	ORTIZ	57	4017807643305	R81922031	VALENTIN	32	4017807637427
R55601132	ORTIZ	57	4017807643312	R81922032	VALENTIN	32	4017807637410
R55601140	ORTIZ	57	4017807643336	R81924031	VALENTIN	32	4017807637441
R55601165	ORTIZ	57	4017807643374	R81924032	VALENTIN	32	4017807637434
R55751007	PAIL	48	4017807642124	R81981731	PIERRE	33	4017807638141
R55751032	PAIL	48	4017807642117	R81981732	PIERRE	33	4017807638158
R55751065	PAIL	48	4017807642148	R81982031	PIERRE	33	4017807638165
R55791131	GINKO	36	4017807642513	R81982032	PIERRE	33	4017807638172
R55791132	GINKO	36	4017807642490	R81983031	PIERRE	33	4017807638189
R55791166	GINKO	36	4017807642506	R81983032	PIERRE	33	4017807638196
R55831101	PONGO	46	4017807642681	R83256332	OBIDOS	84	4017807647976
R55831102	PONGO	46	4017807642698	R84756232	FESTIVAL	80	4017807622584
R55831115	PONGO	46	4017807642711	R86091732	LAURENT	22	4017807637540
R55831143	PONGO	46	4017807642742	R86092032	LAURENT	22	4017807637557
R55951132	SKIP	53	4017807643473	R86093032	LAURENT	22	4017807637564
R55951135	SKIP	53	4017807643503	R86231732	JEROME	21	4017807637694
R55961131	DIAZ	57	4017807644777	R86232032	JEROME	21	4017807637700
R55961132	DIAZ	57	4017807644784	R86233032	JEROME	21	4017807637717
R55961149	DIAZ	57	4017807644807	R86466102	CACERES	86	4017807648263
R55961166	DIAZ	57	4017807644791				
R55961177	DIAZ	57	4017807644814				
R55991126	LIRA	54	4017807643169				

# Kontakte · Contact

Contact · Contact · Contactar · Contatto · Contact · Yhteydenotto · Kontakt

## **TRIO Leuchten GmbH**

Gut Nierhof 17  
D-59757 Arnsberg

T +49 (0) 2931 9666-0  
F +49 (0) 2931 9666-57

info@trio-leuchten.de  
www.trio-leuchten.de

## **Reality Leuchten GmbH**

Gut Nierhof 17  
D-59757 Arnsberg

T +49 (0) 2931 9666-99  
F +49 (0) 2931 9666-98

info@reality-leuchten.de  
www.reality-leuchten.de

## **TRIO International GmbH**

Gut Nierhof 17  
D-59757 Arnsberg

T +49 (0) 2931 9666-587  
F +49 (0) 2931 9666-56

info@trio-lighting.com  
www.trio-lighting.com

## **Baden Württemberg, Rheinland-Pfalz und Saarland**

### **Antonio De Simone**

T +49 (0) 151 58555222  
antonio.desimone@trio-leuchten.de

## **Bayern, Hessen**

### **Martin Kluge**

T +49 (0) 171 7300330  
martin.kluge@trio-leuchten.de

## **Berlin, Brandenburg, Mecklenburg-Vorpommern, Sachsen, Sachsen-Anhalt, Thüringen**

### **Jörg Bumke**

T +49 (0) 160 7406860  
joerg.bumke@trio-leuchten.de

## **Bremen, Hamburg, Niedersachsen, Schleswig-Holstein**

### **Jens Gebers**

T +49 (0) 170 1615227  
jens.gebers@trio-leuchten.de

## **Hessen, Nordrhein-Westfalen Rheinland-Pflaz**

### **Christian Teller**

T +49 (0) 171 4521820  
christian.teller@trio-leuchten.de

## **Österreich**

### **Wolfgang Melich**

T +43 (0) 660 5161228  
wolfgang.melich@trio-leuchten.de

## **Schweiz**

### **TRIO Leuchten GmbH**

T +49 (0) 2931 9666-0  
info@trio-leuchten.de

## **France**

### **Stéphane Papierny**

Directeur Commerciale France  
info.france@trio-lighting.com

### **Julien Lamouret**

Product & Sales Manager DIY France

### **Sullivan Nicolas**

Commercial pour les départements  
01, 03, 07, 21, 23, 26, 38, 39, 42, 43, 48, 63,  
69, 71, 73 et 74

### **Vincent Zaepffel**

Commercial pour les départements  
08, 10, 25, 51, 52, 54, 55, 57, 67, 68, 70,  
88 et 90

### **Christophe Meulien**

Agent commercial pour les départements  
04, 05, 06, 11, 13, 30, 34, 66, 83, 84 et 98

### **Jean Barel**

Agent exclusif pour les départements  
09, 12, 15, 16, 19, 24, 31, 32, 33, 40, 46, 47,  
64, 65, 81, 82 et 87

### **Michel Salamand**

Agent commercial pour les départements  
14, 17, 22, 29, 35, 36, 37, 41, 44, 49, 50, 53, 56,  
61, 72, 79, 85 et 86

### **Stéphane Riebel**

Agent commercial pour les départements  
18, 27, 28, 45, 58, 75, 76, 77, 78, 89, 91, 92, 93,  
94 et 95

### **Sylvain Martin**

Agent commercial pour les territoires  
des DOMTOM

### **Bruno Rouquié**

Agent commercial pour les départements  
09, 12, 15, 16, 19, 24, 31, 32, 33, 40, 46, 47,  
64, 65, 81, 82 et 87

### **Matthieu Soubiran**

Agent commercial pour les départements  
02, 59, 60, 62 et 80

### **Jean Marc Beneforti**

Agent commercial pour les départements  
2a et 2b

## **Belgium**

**Yves Van den Berghe / Frank Boesmans/  
Pauline Delorme**

info.belgium@trio-lighting.com





## Denmark

### Jan Rantzau-Bartens

info.denmark@trio-lighting.com

## Netherlands

### Karl Stok / Bas Martin

info.nederland@trio-lighting.com

## Romania

### Loredana Barbu

info.romania@trio-lighting.com

## Great Britain

### TRIO Lighting UK Ltd.

Unit 5, Hemmells Park Hemmells,

Laindon Essex

SS1s 6GF

T +44 (0) 12 68 88 95 95

F +44 (0) 12 68 88 95 96

sales@trio-lightinguk.com

## Italy

### TRIO Lighting Italia s.r.l

Via Isonzo, 81

22066 Mariano Comense (CO)

T +39 (0) 317 477 55

F +39 (0) 313 551 560

commerciale@trio-lighting.com

## Nordic and Baltic

### TRIO Lighting Scandinavia Oy

Malmin raitti, rappu 17 B

00700 Helsinki

T +358 (0) 10 23 13 390

TLS@trio-lighting.com

*Our Scandinavian organisation represents TRIO also in Estonia, Iceland, Latvia, Lithuania, Norway and Sweden*

## Spain

### TRIO Lighting Ibèrica S.L.

C/VALLESPÍR 19, Plta 2, mòdulo 1.1

08173 Sant Cugat del Vallès

T +34 (0) 935 458 630

info.iberica@trio-lighting.com

## Africa

### F&M Global

T (+32) 4719 22111

hans.deserranno@fmglobal.be

### Ina Concept

T (+32) 4719 94693

jerome.freri@ina-concept.com

## Albania

### Kika Light

T (+355) 672 084 781

kikallight@gmail.com

## Bosnia and Herzegovina

### GRIČ d.o.o.

T (+38) 7039 706 658

daniel.martinovic@tel.net.ba

## Bulgaria

### ATG Bulgaria

T (+359) 899 927 707

deyana\_petrova@atg-apa.net

## Czech Republic

### Luminex spol. s.r.o.

T (+42) 777 570 560

objednavky@luminex.cz

## Greece / Cyprus

### Solomon Lighting S.A.

T (+30) 21060 46003

alberto@solomongroup.gr

## Hungary

### Luxera Kft.

T (+36) 83 3163 88

info@trio-lampa.hu

## Kosovo

### ACN

T (+383) 44 344 434

info@acn-ks.com

## North Macedonia

### Elektro Megavat

T (+389) 71665006

contact@megalight.com.mk

## Polen

### Delighting Polska sp. z.o.o.

T (+48) 61 4367 481

kontakt@delighting.pl

## Republic of Moldova

### Volta LTD

T (+37) 322 26 7775

import5@volta.md

## Serbia

### Aura Light d.o.o. Novi Sad

T (+38) 121 2100724

aura.lightdoo@gmail.com

## Slovakia

### Feim SK s.r.o.

T (+42) 134 7743 228

svietidla@feim.sk

## Slovenia

### BT Trade d.o.o.

T (+386) 41 676 006

info@butiksvetil.si

## Turkey

### Soho Aydinlatma Ticaret Ltd.

T (+90) 2165 7669 41

kartal.kendirici@soholight.com

## Ukraine

### MAX Light

T (+38) 4446 37942

tanya@maxlight.ua

# SAVE THE DATE



**LICHTWOCHE**  
**SAUERLAND**

16.02. – 21.02.2025

lichtforumnrw

Mitglied der Trägergesellschaft Lichtforum NRW e.V.  
Member of the supporting organisation Lichtforum NRW e.V.

TRIO behält sich das Recht vor, zu jeder Zeit, notwendige Änderungen oder Aktualisierungen der in diesem Katalog enthaltenen Produkte vorzunehmen. · TRIO reserves the right to carry out any time, necessary changes or updates of the products in this catalogue. · TRIO se réserve le droit d'apporter à tout moment les modifications ou actualisations nécessaires aux produits dans ce catalogue. · TRIO behoudt zich het recht voor op ieder moment noodzakelijke wijzigingen of updates aan de producten in deze catalogus door te voeren. · TRIO se reserva , en todo momento, el derecho a realizar las modificaciones o actualizaciones que considere necesarias para cualquier producto de este catálogo. · TRIO si riserva il diritto di apportare, in qualunque momento, tutte le modifiche necessarie ai prodotti di questo catalogo. · TRIO-ul își rezervă dreptul de a face oricând orice modificări sau actualizări necesare pentru produsele din acest catalog. · TRIO pidättää oikeuden tehdä muutoksia tai päivittää tuotteita tässä luettelossa. · TRIO zastrzega sobie prawo do wprowadzania w dowolnym czasie zmian lub aktualizacji produktów zawartych w katalogu.



LIGHTING FOR YOU



**TRIO Leuchten GmbH**

Gut Nierhof 17  
D-59757 Arnsberg

T +49 2931 9666-0  
F +49 2931 9666-57

info@trio-leuchten.de  
www.trio-leuchten.de

**Reality Leuchten GmbH**

Gut Nierhof 17  
D-59757 Arnsberg

T +49 2931 9666-99  
F +49 2931 9666-98

info@reality-leuchten.de  
www.reality-leuchten.de

**TRIO International GmbH**

Gut Nierhof 17  
D-59757 Arnsberg

T +49 2931 9666-587  
F +49 2931 9666-56

info@trio-lighting.com  
www.trio-lighting.com

