



TREND & STYLE

COLLECTION

2024/25



TREND & STYLE COLLECTION

Dear business partners and faithful friends of EGLO,

It is with great pleasure that we present to you the updated Trend & Style catalogue for the 2024/25 season. In addition to a wealth of already familiar favourites, we are pleased to combine our new products with current design trends again this year.

The unique fusion of Japanese minimalism and Scandinavian style, also known as Japandi, gives our lights a subtle elegance. By combining simplicity, clean lines and the use of natural materials, Japandi style luminaires reflect a timeless character.

In keeping with this, the Nature trend combines organic shapes and natural materials to create a harmonious connection between indoor and outdoor spaces. This creates a relaxed and sustainable living atmosphere.

True to our credo "my light | my style", you will find a light for every interior design style in the updated Trend & Style catalogue.

Sehr geehrte Geschäftspartner*innen, treue Freund*innen von EGLO,

mit großer Freude präsentieren wir Ihnen den aktualisierten Trend & Style Katalog für die Saison 2024/25. Neben einer Fülle an bereits bekannten Favoriten freuen wir uns auch dieses Jahr unsere Neuheiten mit aktuellen Designtrends zu verbinden.

Die einzigartige Fusion aus japanischem Minimalismus und skandinavischem Stil, auch bekannt als Japandi, verleiht unseren Leuchten eine subtile Eleganz. Durch die Kombination von Einfachheit, klaren Linien und dem Einsatz natürlicher Materialien spiegeln die Leuchten im Japandi-Stil einen zeitlosen Charakter wider.

Passend dazu verbindet der Nature Trend organische Formen und natürliche Materialien, um eine harmonische Verbindung zwischen Innen- und Außenraum zu schaffen. Dadurch entsteht eine entspannte und nachhaltige Wohnatmosphäre.

Ganz nach unserem Credo "my light | my style" finden Sie im aktualisierten Trend & Style Katalog eine Leuchte für jeden Einrichtungsstil.

Chers partenaires, chers amis fidèles d'EGLO,

Nous avons le plaisir de vous présenter le nouveau catalogue Trend & Style 2024/25. Outre une multitude de nouveautés et d'articles favoris déjà connus, nous vous surprenons avec une nouvelle tendance: Japandi, une combinaison des styles japonais et scandinave, reflétant une esthétique minimaliste et fonctionnelle. Les luminaires de style Japandi se distinguent par leur simplicité, leurs lignes épurées et l'utilisation de matériaux naturels.

Ajoutez une touche sophistiquée à votre intérieur avec nos luminaires de la collection Tend & Styles. Des lustres rustiques aux lampes de table en passant par les suspensions, ils représentent l'élégance intemporelle du passé et font de votre espace un lieu très spécial.

Conformément à notre credo „my light | my style“, vous trouverez dans le nouveau catalogue Trend & Style un luminaire pour chaque style d'intérieur.

EDITORIAL

Our Trend & Style collection features the latest trends for the 2024/25 season.

Our luminaire portfolio has been expanded to include exciting compositions made from natural materials, metal and glass. Exciting compositions made of natural materials, metal and glass have been added to our luminaire portfolio. Dried bamboo and birch leaves on flax fleece and luminaires made of paper are the highlights of our new luminaire designs.

In der Trend & Style Kollektion erwarten Sie die aktuellen Trend-Welten der Saison 2024/25.

Unser Leuchten Portfolio wurde um spannende Kompositionen aus Naturmaterialien, Metall und Glas ergänzt. Getrocknete Bambus- und Birkenblätter auf Flachsvlies und Leuchten aus Papier sind die Highlights unserer neuen Leuchten-Designs.

Dans la collection Trend & Style, vous trouverez toutes les tendances actuelles de la saison 2024/25.

Notre portefeuille de luminaires a été complété par des compositions passionnantes en matériaux naturels, métal et verre. Des feuilles de bambou et de bouleau séchées sur un voile de lin et des luminaires en papier sont les points forts de nos nouveaux designs de luminaires.

INDUSTRIAL

4



LOFT

76



JAPANDI

180



NATURE

202



VINTAGE

240



ETHNO ELEGANCE

260



SOCKETS & ILLUMINANTS

270



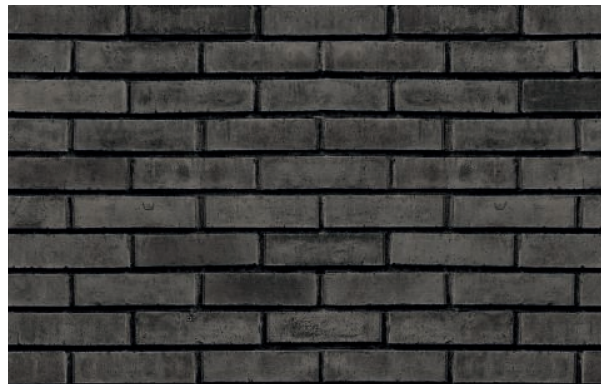

INDUSTRIAL

#RAW
#BRICKS

Soft lines, playful curves and comfort? Certainly not. The industrial range is dominated by hard and functional elements. Raw metal parts are turned into luminaires and spread the rough style of factory halls. The Industrial Look celebrates the aesthetic of things imperfect.

Weiche Linien, verspielte Rundungen und Gemütlichkeit? Mitnichten. Im Industrial Sortiment dominieren harte und funktionelle Elemente. Rohe Metallteile werden zu Leuchten verarbeitet und verbreiten den groben Stil von Fabrikhallen. Der Industrial Look zelebriert die Ästhetik des Imperfekten.

Des lignes tendres, des arrondis enjoués et de la convivialité ? En aucun cas. Des éléments durs et fonctionnels dominant la gamme industrielle. Des pièces métalliques brutes sont usinées pour devenir des luminaires et diffusent le style franc d'usines. Le look industriel symbolise l'esthétique de l'imperfection.

MILLIGAN 6	PONTEFRACT 9	MANBY 10-11	RINROE 12-13	ROUNDHAM 14	DELLOW 16-17	NOHALES 19	REDCLIFFE 20
CATTERICK 22	IKESTON 24-25	SPEKE 26	SEDBERGH 27	TAKELEY 28	BARNSTAPLE 1 30-31	SHIREBROOK 31	BARNSTAPLE 32-35
LUBENHAM 1 36	LUBENHAM 36-37	WINKWORTH 1 38	EBURY 39	TRURO 1 40	TRURO 2 40, 42	GRANTHAM 1 40	AUCKLAND 42
PRIDDY 1 42	PRIDDY 45-46	TREBURY 48	COVALEDA 48	MARDYKE 50-51	EMBLETON 51	LONGINO 52	TOOTHILL 53
CHARTERHOUSE 54	ELSWICK 56	FEMBARD 56	WILMCOTE 56	OLDBURY 58	TOWNSHEND 4 59-61	PRESTWICK 2 62-63	PRESTWICK 63
GATEBECK 64	MACCLES 66-67	CAWTON 68-69	LAYHAM 70	HARBOROUGH 72	EVESHAM 72-73	KILNSDALE 74	



This product is available in different colors and shapes./ Dieser Artikel ist in unterschiedlichen Farben und Formen verfügbar.
Cet article est disponible en différentes couleurs et formes.



43626

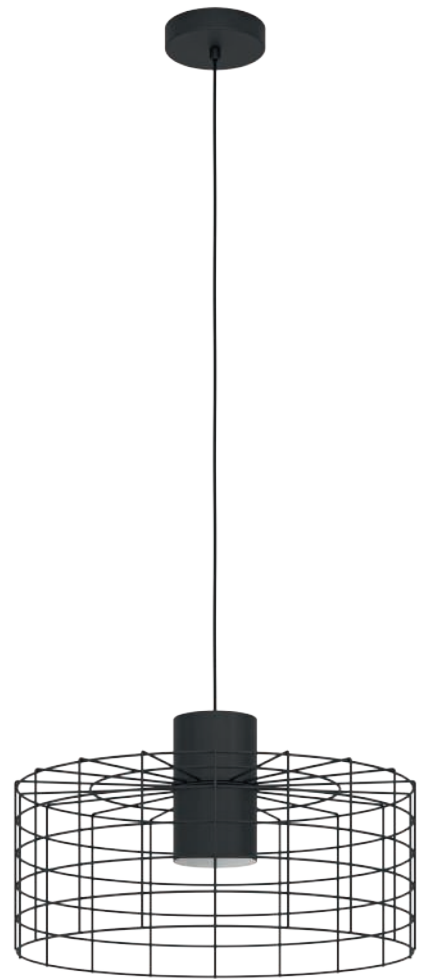

43628

43626 MILLIGAN

pendant light; steel, black, white
 Hängeleuchte; Stahl, schwarz, weiss
 luminaire en suspension; acier, noir, blanc

L 1030, B 200, H 1100



E27 3x 40W



9 002759 436261

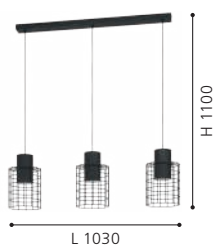

43628 MILLIGAN

pendant light; steel, black, white
 Hängeleuchte; Stahl, schwarz, weiss
 luminaire en suspension; acier, noir, blanc

H 1100, Ø 480



E27 1x 40W



9 002759 436285

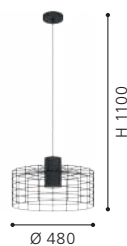

43627 MILLIGAN

pendant light; steel, black, white
 Hängeleuchte; Stahl, schwarz, weiss
 luminaire en suspension; acier, noir, blanc

H 1100, Ø 380



E27 1x 40W



9 002759 436278

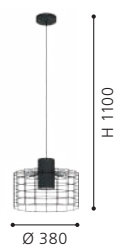



43627

FRANK GEHRY Charles Jencks
INTERIORS | THE COMPLETE COLLECTION
1 Architecture + Interiors

Made with love
CANDLE
Matin Blanc



43891

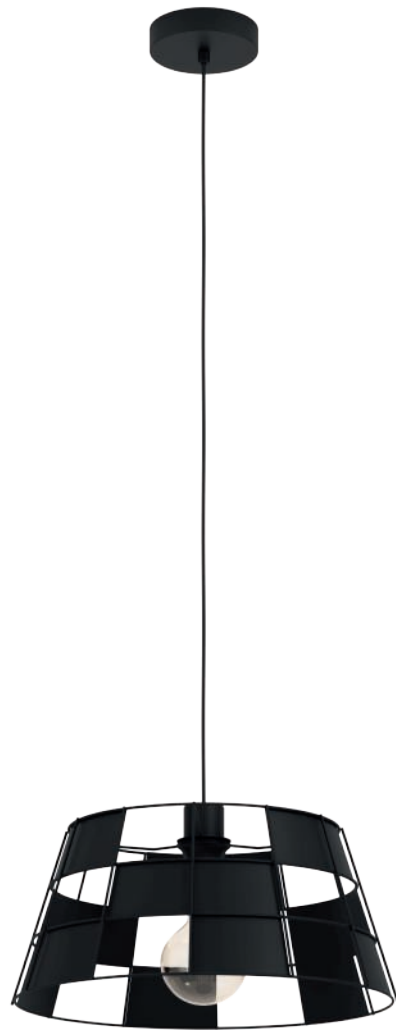

43892

DESIGN
HIGHLIGHT
DETAIL



43891 PONTEFRACT

ceiling light; steel, black
Deckenleuchte; Stahl, schwarz
plafonnier; acier, noir

H 205, Ø 420



E27



1x 40W



9 002759 438913



43892 PONTEFRACT

pendant light; steel, black
Hängeleuchte; Stahl, schwarz
luminaire en suspension; acier, noir

H 1100, Ø 420



E27



1x 40W



9 002759 438920





43796

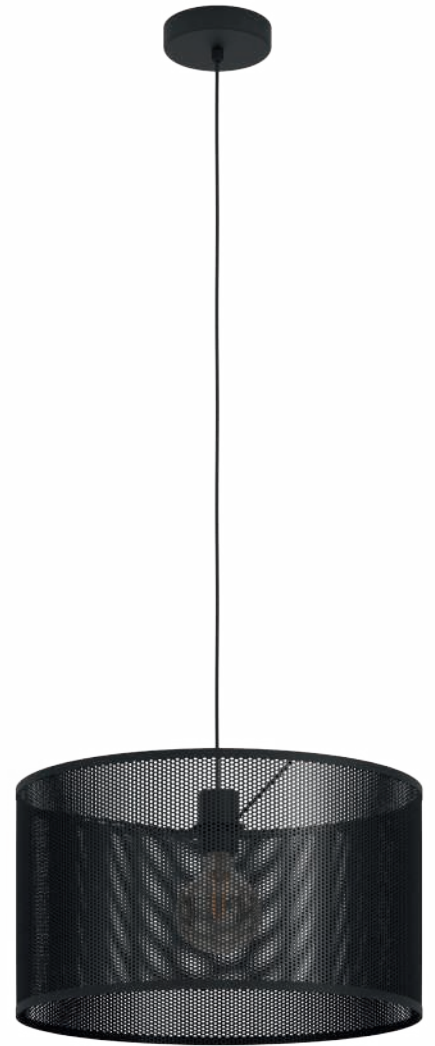

43795

43796 MANBY

pendant light; steel, black
 Hängeleuchte; Stahl, schwarz
 luminaire en suspension; acier, noir

L 900, B 200, H 1100



E27



3x 40W



9 002759 437961



43795 MANBY

pendant light; steel, black
 Hängeleuchte; Stahl, schwarz
 luminaire en suspension; acier, noir

H 1100, Ø 450



E27



1x 40W



9 002759 437954





43794



43794 MANBY

ceiling light; steel, black
Deckenleuchte; Stahl, schwarz
plafonnier; acier, noir

H 280, Ø 450



E27



1x 40W



9 002759 437947

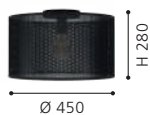

43797 MANBY

table light; steel, black
Tischleuchte; Stahl, schwarz
luminaire de table; acier, noir

H 485, Ø 240, Base: Ø 230



E27



1x 40W



9 002759 437978





DESIGN
HIGHLIGHT
DETAIL



43966

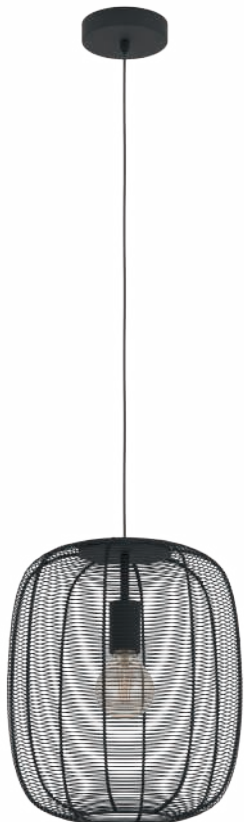

43965



43968

43965 RINROE

pendant light; steel, black
Hängeleuchte; Stahl, schwarz
luminaire en suspension; acier, noir

H 1100, Ø 325



E27 1x 40W



9 002759 439651



43966 RINROE

pendant light; steel, black
Hängeleuchte; Stahl, schwarz
luminaire en suspension; acier, noir

L 900, B 325, H 1100



E27 2x 40W



9 002759 439668



43968 RINROE

floor light; steel, black
Stehleuchte; Stahl, schwarz
lampadaire; acier, noir

H 1405, Ø 325, Base: Ø 630



E27 1x 40W



9 002759 439682

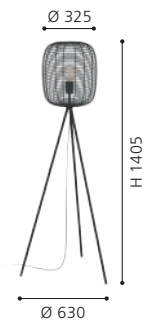



43967

43967 RINROE

table light; steel, black
Tischleuchte; Stahl, schwarz
luminaire de table; acier, noir

H 440, Ø 200, Base: Ø 225



E27



1x 40W



9 002759 439675



43896 RINROE

ceiling light; steel, black
Deckenleuchte; Stahl, schwarz
plafonnier; acier, noir

H 200, Ø 450



E27



1x 40W



9 002759 438968

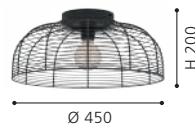

43896

DESIGN
HIGHLIGHT
DETAIL

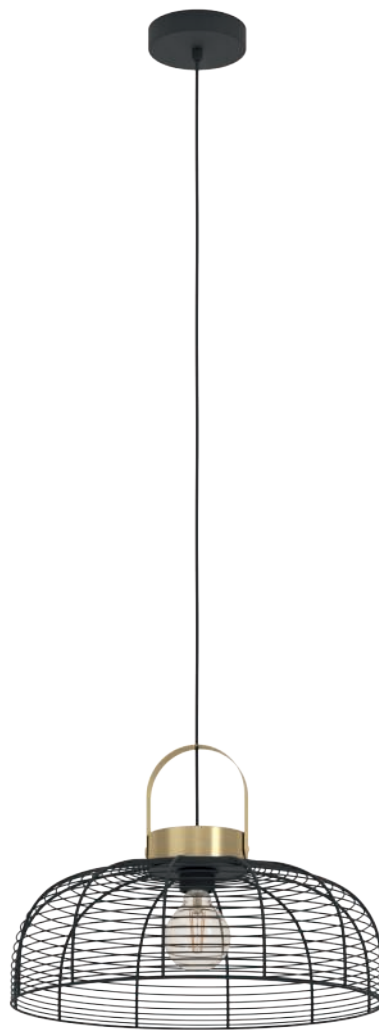

43964

43964 ROUNDHAM

pendant light; steel, black, brushed brass
Hängeleuchte; Stahl, schwarz, messing-gebürstet
luminaire en suspension; acier, noir, laiton brossé

H 1100, Ø 450



E27 1x 40W



9 002759 439644



43963 ROUNDHAM

pendant light; steel, black, brushed brass
Hängeleuchte; Stahl, schwarz, messing-gebürstet
luminaire en suspension; acier, noir, laiton brossé

H 1100, Ø 220



E27 1x 40W



9 002759 439637





43963



43605



43603

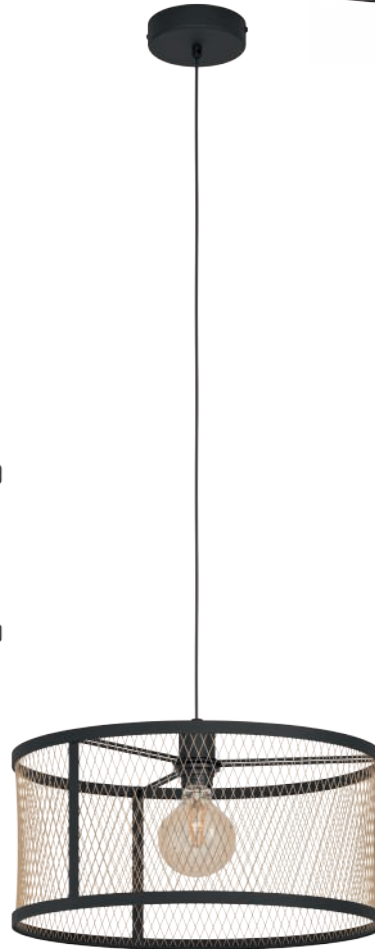

43604

43605 DELLOW

pendant light; steel, black / steel, black, brass
 Hängeleuchte; Stahl, schwarz / Stahl, schwarz, messing
 luminaire en suspension; acier, noir / acier, noir, laiton

L 880, B 180, H 1100



E27 3x 40W



9 002759 436056



43604 DELLOW

pendant light; steel, black / steel, black, brass
 Hängeleuchte; Stahl, schwarz / Stahl, schwarz, messing
 luminaire en suspension; acier, noir / acier, noir, laiton

H 1100, Ø 450



E27 1x 40W



9 002759 436049



43603 DELLOW

ceiling light; steel, black / steel, black, brass
 Deckenleuchte; Stahl, schwarz / Stahl, schwarz, messing
 plafonnier; acier, noir / acier, noir, laiton

H 270, Ø 450



E27 1x 40W



9 002759 436032





43533



43531



43532

43533 DELLOW

spot; steel, black / steel, black, brass
 Spot; Stahl, schwarz / Stahl, schwarz, messing
 spot; acier, noir / acier, noir, laiton

L 830, B 180, H 210



E27



3x 40W



9 002759 435332



L 830

H 210

43532 DELLOW

spot; steel, black / steel, black, brass
 Spot; Stahl, schwarz / Stahl, schwarz, messing
 spot; acier, noir / acier, noir, laiton

L 475, B 180, H 210



E27



2x 40W



9 002759 435325



L 475

H 210

43531 DELLOW

spot; steel, black / steel, black, brass
 Spot; Stahl, schwarz / Stahl, schwarz, messing
 spot; acier, noir / acier, noir, laiton

L 180, B 110, H 200



E27



1x 40W



9 002759 435318

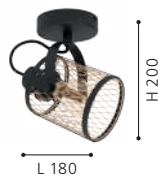

L 180

H 200

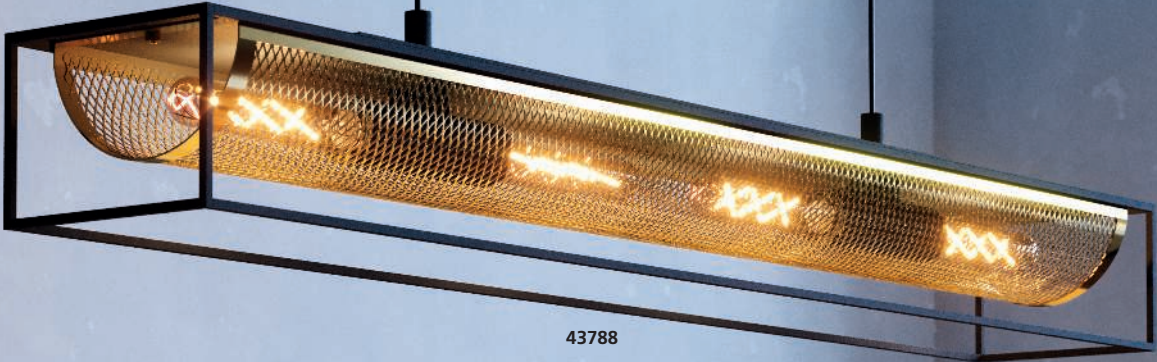

43788



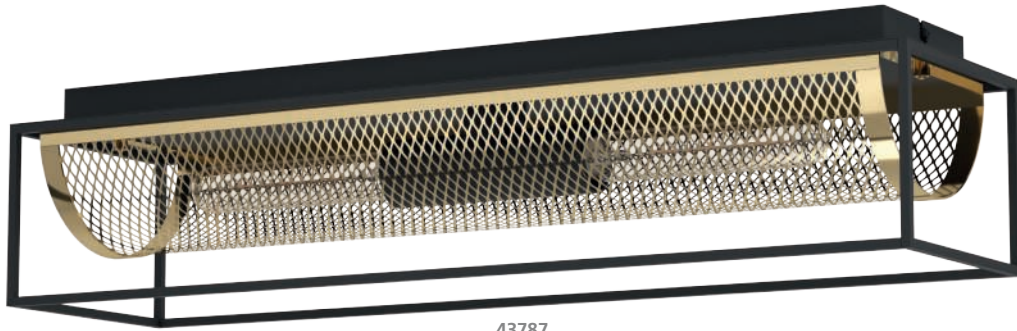

43787



43789



43788 NOHALES

pendant light; steel, black, brass
Hängeleuchte; Stahl, schwarz, messing
luminaire en suspension; acier, noir, laiton

L 1120, B 170, H 1500



E27



4x 40W



9 002759 437886



43789 NOHALES

wall light; steel, black, brass
Wandleuchte; Stahl, schwarz, messing
Applique; acier, noir, laiton

L 170, H 320, A 145



E27



1x 40W



9 002759 437893



43787 NOHALES

ceiling light; steel, black, brass
Deckenleuchte; Stahl, schwarz, messing
plafonnier; acier, noir, laiton

L 640, B 170, H 145



E27



2x 40W



9 002759 437879

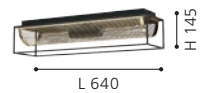



43534



43535

DETAIL 43534

To replace the bulbs, the two halves of the luminaires can be taken apart in the middle.

Zum Tausch der Leuchtmittel können die beiden Hälften der Leuchten in der Mitte auseinander genommen werden.

Pour remplacer les ampoules, les deux moitiés des luminaires peuvent être séparées au milieu.

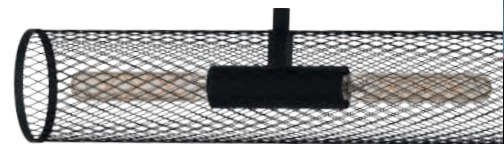

43534 REDCLIFFE

pendant light; steel, black
Hängeleuchte; Stahl, schwarz
luminaire en suspension; acier, noir

L 1080, B 125, H 1100



E27 4x 40W



9 002759 435349



L 1080

H 1100

43535 REDCLIFFE

wall/ceiling light; steel, black
Wand- / Deckenleuchte; Stahl, schwarz
Applique/Plafonnier; acier, noir

L 540, B 120, H 145



E27 2x 40W



9 002759 435356

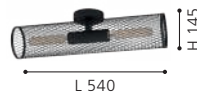

L 540

H 145

43537 REDCLIFFE

floor light; steel, black
Stehleuchte; Stahl, schwarz
lampadaire; acier, noir

H 1355, Ø 120, Base: Ø 250



E27 4x 40W



9 002759 435370



Ø 120

H 1355

Ø 250



43537



43773



DESIGN
HIGHLIGHT
DETAIL

43773 CATTERICK

pendant light; steel, black
Hängeleuchte; Stahl, schwarz
luminaire en suspension; acier, noir

L 910, B 165, H 1100



E27



4x 40W



9 002759 437732



43772 CATTERICK

ceiling light; steel, black
Deckenleuchte; Stahl, schwarz
plafonnier; acier, noir

L 350, B 165, H 190



E27



2x 40W



9 002759 437725





43772





43728

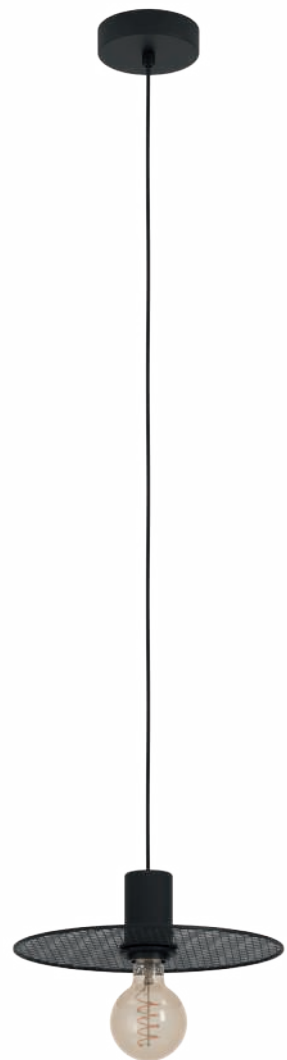

43731

43728 IKESTON

ceiling light; steel, black
Deckenleuchte; Stahl, schwarz
plafonnier; acier, noir

H 130, Ø 530



E27



3x 40W



9 002759 437282



43731 IKESTON

pendant light; steel, black
Hängeleuchte; Stahl, schwarz
luminaire en suspension; acier, noir

H 1100, Ø 280



E27



1x 40W



9 002759 437312

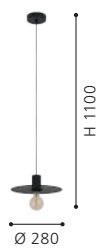



43729



43732

43732 IKESTON

pendant light; steel, black
Hängeleuchte; Stahl, schwarz
luminaire en suspension; acier, noir

L 980, B 280, H 1100



E27



4x 40W



9 002759 437329

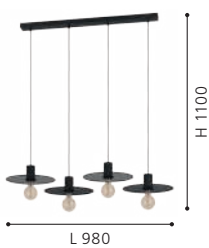

H 1100

L 980

43729 IKESTON

ceiling light; steel, black
Deckenleuchte; Stahl, schwarz
plafonnier; acier, noir

L 950, B 330, H 120



E27



4x 40W



9 002759 437299



H 120

L 950



43722 SPEKE

ceiling light; steel, black
Deckenleuchte; Stahl, schwarz
plafonnier; acier, noir

L 1560, B 310, H 105



E27



11x 40W



9 002759 437220

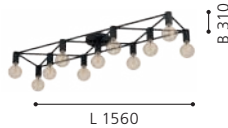

43721 SPEKE

ceiling light; steel, black
Deckenleuchte; Stahl, schwarz
plafonnier; acier, noir

L 415, B 310, H 105



E27



5x 40W



9 002759 437213

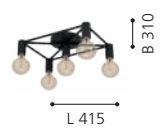

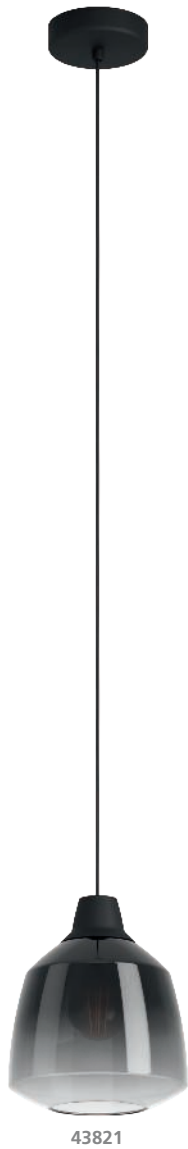

43821



43822

43821 SEDBERGH

pendant light; steel, black / glass, black-grey-transparent
 Hängeleuchte; Stahl, schwarz / Glas, schwarz-grau-transparent
 luminaire en suspension; acier, noir / verre, noir gris transparent

H 1100, Ø 200



E27



1x 40W



9 002759 438210



43822 SEDBERGH

pendant light; steel, black / glass, black-grey-transparent
 Hängeleuchte; Stahl, schwarz / Glas, schwarz-grau-transparent
 luminaire en suspension; acier, noir / verre, noir-gris transparent

L 900, B 200, H 1100



E27



3x 40W



9 002759 438227



DESIGN
HIGHLIGHT
DETAIL



DETAIL TAKELEY

The arms of the luminaires are individually adjustable.
Die Arme der Leuchten sind individuell einstellbar.
Les bras des luminaires sont réglables individuellement.



43562

43562 TAKELEY

ceiling light; steel, black
Deckenleuchte; Stahl, schwarz
plafonnier; acier, noir

B 1980, H 1325



E27



2x 28W



9 002759 435622

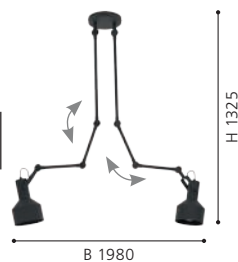

43561 TAKELEY

ceiling light; steel, black
Deckenleuchte; Stahl, schwarz
plafonnier; acier, noir

H 1325, Ø 150



E27



1x 28W



9 002759 435615

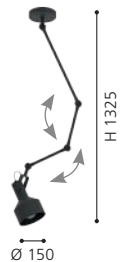



43561





43431



43432



43433

43431 BARNSTAPLE 1

spot; wood, steel, black / steel, black
Spot; Holz, Stahl, schwarz / Stahl, schwarz
spot; bois, acier, noir / acier, noir

L 160, B 160



E27 1x 28W



9 002759 434311



L 160

B 160

43432 BARNSTAPLE 1

spot; wood, steel, black / steel, black
Spot; Holz, Stahl, schwarz / Stahl, schwarz
spot; bois, acier, noir / acier, noir

L 475, B 90



E27 2x 40W



9 002759 434328



L 475

B 90

43433 BARNSTAPLE 1

spot; wood, steel, black / steel, black
Spot; Holz, Stahl, schwarz / Stahl, schwarz
spot; bois, acier, noir / acier, noir

L 750, B 90



E27 3x 40W



9 002759 434335



L 750

B 90



43434



43726



43434 BARNSTAPLE 1

spot; wood, steel, black / steel, black
Spot; Holz, Stahl, schwarz / Stahl, schwarz
spot; bois, acier, noir / acier, noir

L 450, B 450



E27



4x 40W



9 002759 434342



L 450

43726 SHIREBROOK

pendant light; steel, wood, black
Hängeleuchte; Stahl, Holz, schwarz
luminaire en suspension; acier, bois, noir

L 1000, B 250, H 1100



E27



4x 40W



9 002759 437268



L 1000

H 1100



49648



49653



49652

49648 BARNSTAPLE

spot; wood, steel, brown-patina, black / steel, distressed zinc
 Spot; Holz, Stahl, braun-patina, schwarz / Stahl, used look
 Zink
 spot; bois, acier, marron patiné, noir / acier, look zinc usé

L 160, B 160



9 002759 496487



49652 BARNSTAPLE

spot; wood, steel, brown-patina, black / steel, distressed zinc
 Spot; Holz, Stahl, braun-patina, schwarz / Stahl, used look
 Zink
 spot; bois, acier, marron patiné, noir / acier, look zinc usé

L 750, B 90



9 002759 496524



49653 BARNSTAPLE

spot; wood, steel, brown-patina, black / steel, distressed zinc
 Spot; Holz, Stahl, braun-patina, schwarz / Stahl, used look
 Zink
 spot; bois, acier, marron patiné, noir / acier, look zinc usé

L 450, B 450



9 002759 496531





49649

49649 BARNSTAPLE

spot; wood, steel, brown-patina, black / steel, distressed zinc
Spot; Holz, Stahl, braun-patina, schwarz / Stahl, used look
Zink
spot; bois, acier, marron patiné, noir / acier, look zinc usé

L 475, B 90



E27



2x 40W



9 002759 496494





49647



49722



49718

49647 BARNSTAPLE

pendant light; wood, steel, brown-patina, black / steel, distressed zinc

Hängeleuchte; Holz, Stahl, braun-patina, schwarz / Stahl, used look Zink

luminaire en suspension; bois, acier, marron patiné, noir / acier, look zinc usé

H 1500, Ø 270



E27 3x 40W



9 002759 496470



49722 BARNSTAPLE

floor light; wood, steel, brown-patina, black / steel, distressed zinc

Stehleuchte; Holz, Stahl, braun-patina, schwarz / Stahl, used look Zink

lampadaire; bois, acier, marron patiné, noir / acier, look zinc usé

H 1580, Base: Ø 270

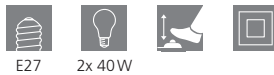

E27 2x 40W



9 002759 497224

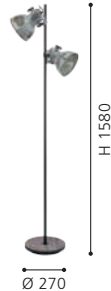

49718 BARNSTAPLE

table light; wood, steel, brown-patina, black / steel, distressed zinc

Tischleuchte; Holz, Stahl, braun-patina, schwarz / Stahl, used look Zink

luminaire de table; bois, acier, marron patiné, noir / acier, look zinc usé

B 175, H 400, Base: Ø 180



E27 1x 40W



9 002759 497187





49619

49619 BARNSTAPLE

pendant light; steel, black / steel, distressed zinc
Hängeleuchte; Stahl, schwarz / Stahl, used look Zink
luminaire en suspension; acier, noir / acier, look zinc usé

H 1100, Ø 175



E27



1x 40W



9 002759 496197



DESIGN
HIGHLIGHT
DETAIL





43168



44057



44056



43168 LUBENHAM 1

pendant light; steel, antique nickel, cream
 Hängeleuchte; Stahl, nickel-antik, creme
 luminaire en suspension; acier, nickel antique, crème

L 900, B 200, H 1100



E27 3x 28W



9 002759 431686

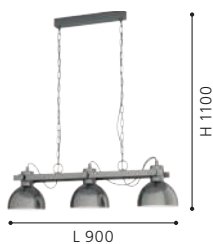

44056 LUBENHAM

pendant light; steel, wood, black, brown
 Hängeleuchte; Stahl, Holz, schwarz, braun
 luminaire en suspension; acier, bois, noir, marron

H 1100, Ø 300



E27 1x 28W



9 002759 440565



44057 LUBENHAM

wall light; steel, wood, black, brown
 Wandleuchte; Stahl, Holz, schwarz, braun
 Applique; acier, bois, noir, marron

L 175, H 205, A 210



E27 1x 28W



9 002759 440572





44058

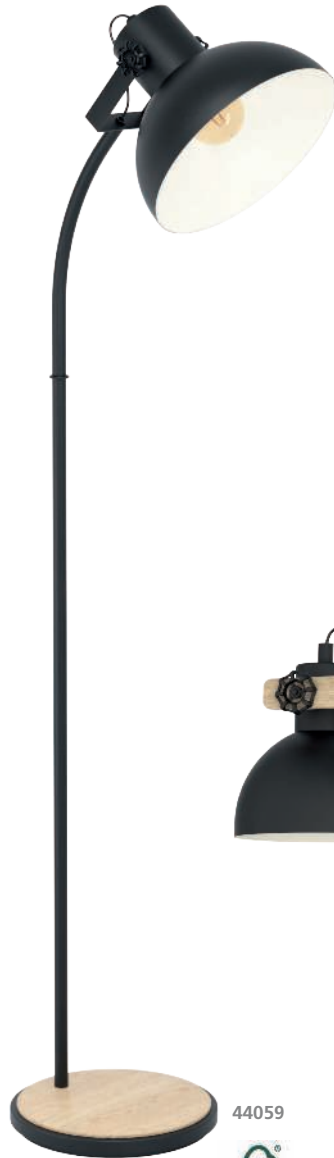

44059



43992



44058 LUBENHAM

table light; steel, wood, black, brown
Tischleuchte; Stahl, Holz, schwarz, braun
luminaire de table; acier, bois, noir, marron

L 355, H 570, Base: Ø 180



E27 1x 28W



9 002759 440589



44059 LUBENHAM

floor light; steel, wood, black, brown
Stehleuchte; Stahl, Holz, schwarz, braun
lampadaire; acier, bois, noir, marron

L 475, B 300, H 1600, Base: Ø 300



E27 1x 28W



9 002759 440596

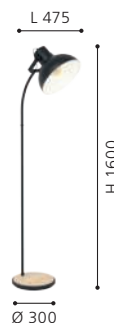

43992 LUBENHAM

pendant light; steel, wood, black, brown
Hängeleuchte; Stahl, Holz, schwarz, braun
luminaire en suspension; acier, bois, noir, marron

L 900, B 200, H 1100



E27 3x 28W



9 002759 439927

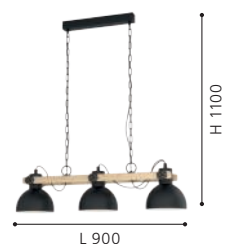



43435



43436



DETAIL WINKWORTH 1

The distance of the luminaires to the ceiling is individually adjustable due to the additional weight.

Der Abstand der Leuchten zur Decke ist durch das zusätzliche Gewicht individuell verstellbar.

La distance entre les luminaires et le plafond peut être réglée individuellement grâce au poids supplémentaire.

43435 WINKWORTH 1

pendant light; steel, black
Hängeleuchte; Stahl, schwarz
luminaire en suspension; acier, noir

H 910 - 1900, Ø 380



E27 1x 40W



9 002759 434359



43436 WINKWORTH 1

pendant light; steel, black
Hängeleuchte; Stahl, schwarz
luminaire en suspension; acier, noir

L 1180, B 380, H 910 - 1900



E27 2x 40W



9 002759 434366

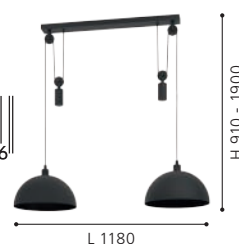



43621



43622

43621 Ebury

pendant light; steel, black, white
Hängeleuchte; Stahl, schwarz, weiss
luminaire en suspension; acier, noir, blanc

H 1100, Ø 380



E27



1x 60W



9 002759 436216



43622 Ebury

pendant light; steel, grey, white
Hängeleuchte; Stahl, grau, weiss
luminaire en suspension; acier, gris, blanc

H 1100, Ø 380



E27



1x 60W



9 002759 436223



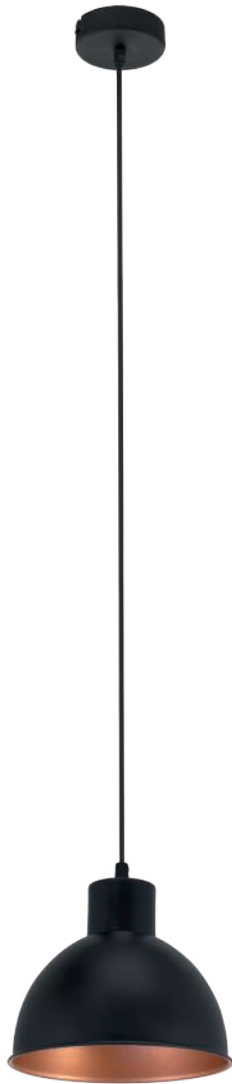

49238

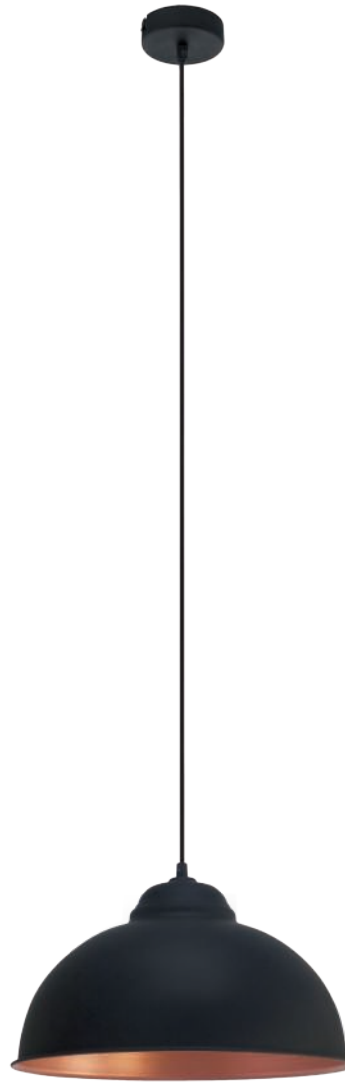

49247

49238 TRURO 1

pendant light; steel, black, copper
Hängeleuchte; Stahl, schwarz, kupfer
luminaire en suspension; acier, noir, cuivre

H 1100, Ø 210



E27 1x 60W



9 002759 492380



49247 TRURO 2

pendant light; steel, black, copper
Hängeleuchte; Stahl, schwarz, kupfer
luminaire en suspension; acier, noir, cuivre

H 1100, Ø 370



E27 1x 60W



9 002759 492472



49819 GRANTHAM 1

pendant light; steel, antique brown, beige
Hängeleuchte; Stahl, antik-braun, beige
luminaire en suspension; acier, marron antique, beige

H 1100, Ø 370



E27 1x 60W



9 002759 498191





49819

DESIGN
HIGHLIGHT
DETAIL

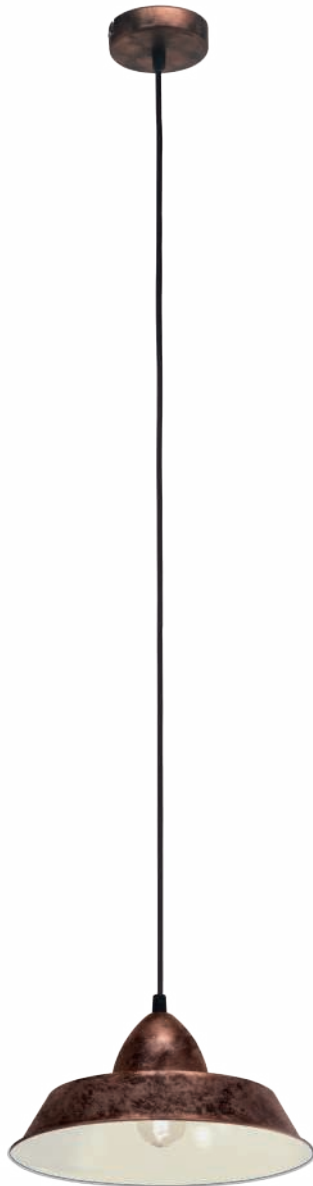

49243



49492

49243 AUCKLAND

pendant light; steel, antique copper coloured
Hängeleuchte; Stahl, kupferfarben-antik
luminaire en suspension; acier, cuivré antique

H 1100, Ø 260



E27 1x 60W



9 002759 492434



49492 PRIDDY 1

pendant light; steel, antique copper coloured
Hängeleuchte; Stahl, kupferfarben-antik
luminaire en suspension; acier, cuivré antique

H 1100, Ø 155



E27 1x 40W



9 002759 494926



49248 TRURO 2

pendant light; steel, antique copper coloured
Hängeleuchte; Stahl, kupferfarben-antik
luminaire en suspension; acier, cuivré antique

H 1100, Ø 370



E27 1x 60W



9 002759 492489





49248



43878





49464



49466

43878 PRIDDY

pendant light; steel, black, white
Hängeleuchte; Stahl, schwarz, weiss
luminaire en suspension; acier, noir, blanc

H 1100, Ø 305



E27



1x 40W



9 002759 438784

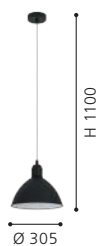

49464 PRIDDY

pendant light; steel, black, white
Hängeleuchte; Stahl, schwarz, weiss
luminaire en suspension; acier, noir, blanc

H 1100, Ø 155



E27



1x 40W



9 002759 494643



49466 PRIDDY

pendant light; steel, black, white
Hängeleuchte; Stahl, schwarz, weiss
luminaire en suspension; acier, noir, blanc

L 975, B 155, H 1100



E27



4x 40W



9 002759 494667





49468



49469

49468 PRIDDY

wall light; steel, black, white
Wandleuchte; Stahl, schwarz, weiss
Applique; acier, noir, blanc

L 130, H 215, A 200



E27 1x 40W



9 002759 494681



49469 PRIDDY

table light; steel, black, white
Tischleuchte; Stahl, schwarz, weiss
luminaire de table; acier, noir, blanc

H 425, Base: Ø 155



E27 1x 40W



9 002759 494698



49471 PRIDDY

floor light; steel, black, white
Stehleuchte; Stahl, schwarz, weiss
lampadaire; acier, noir, blanc

H 1370, Base: Ø 230

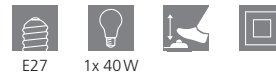

E27 1x 40W



9 002759 494711

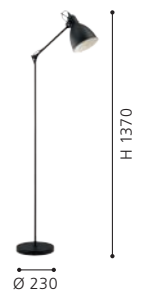



49471



DETAIL 43184

The luminaires can be individually extended by the movable and extendable arms.

Die Leuchten können durch die beweglichen und ausziehbaren Arme individuell verlängert werden.

Les luminaires peuvent être rallongés individuellement grâce aux bras mobiles et extensibles.



43184 TREBURLEY

wall light; steel, black, gold
Wandleuchte; Stahl, schwarz, gold
Applique; acier, noir, or

L 155, B 650, H 200



E27 1x 28W



9 002759 431846



49617 COVALEDA

table light; wood, steel, black, brass, gold
Tischleuchte; Holz, Stahl, schwarz, messing, gold
luminaire de table; bois, acier, noir, laiton, or

H 735, Ø 380



E27 1x 60W



9 002759 496173



49618 COVALEDA

floor light; wood, steel, black, brass, gold
Stehleuchte; Holz, Stahl, schwarz, messing, gold
lampadaire; bois, acier, noir, laiton, or

H 1640, Ø 550

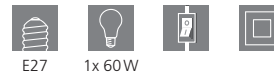

E27 1x 60W



9 002759 496180

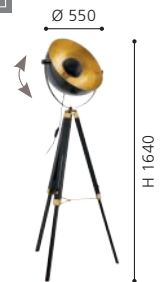



49617

49618



DETAIL MARDYKE

This luminaire series has a unique look with the mixture of steel and clear glass.

Diese Leuchtenserie verfügt mit der Mischung aus Stahl und Klarglas über eine einzigartige Optik.

Cette série de luminaires a un look unique avec le mélange d'acier et de verre transparent.

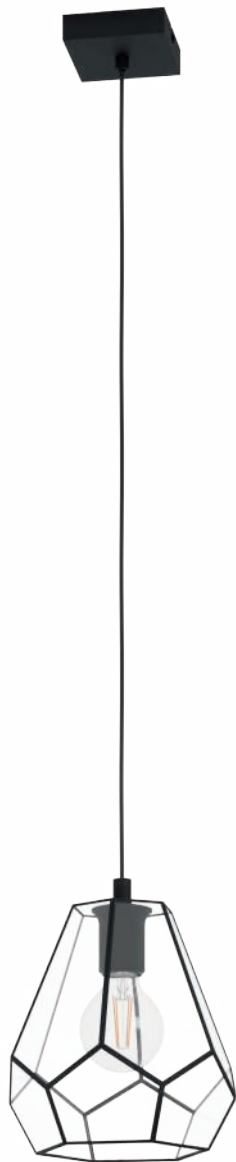

43643



43645



43646

43643 MARDYKE

pendant light; steel, black / glass, clear
Hängeleuchte; Stahl, schwarz / Glas, klar
luminaire en suspension; acier, noir / verre, transparent

H 1100, Ø 230



E27



1x 40W



9 002759 436438

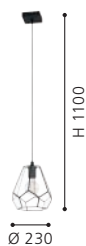

43645 MARDYKE

wall light; steel, black / glass, clear
Wandleuchte; Stahl, schwarz / Glas, klar
Applique; acier, noir / verre, transparent

L 145, H 205, A 195



E27



1x 40W



9 002759 436452

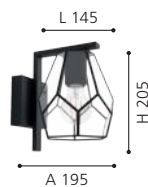

43646 MARDYKE

table light; steel, black / glass, clear
Tischleuchte; Stahl, schwarz / Glas, klar
luminaire de table; acier, noir / verre, transparent

L 190, B 150, H 505, Base: B 188, T 128



E27



1x 40W



9 002759 436469



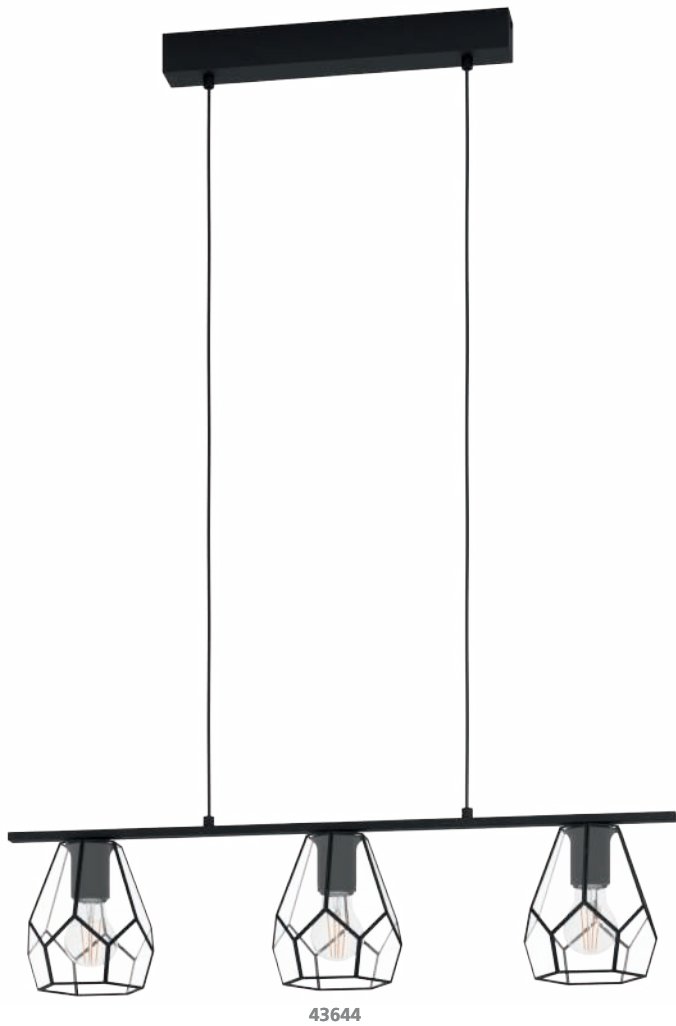

43644



49762

43644 MARDYKE

pendant light; steel, black / glass, clear
 Hängeleuchte; Stahl, schwarz / Glas, klar
 luminaire en suspension; acier, noir / verre, transparent

L 775, B 145, H 1100



E27



3x 40W



9 002759 436445

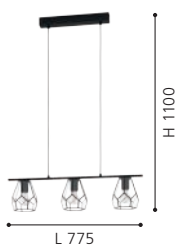

L 775

H 1100

49762 EMBLETON

pendant light; steel, black
 Hängeleuchte; Stahl, schwarz
 luminaire en suspension; acier, noir

H 1500, Ø 460



E27



1x 60W



9 002759 497620

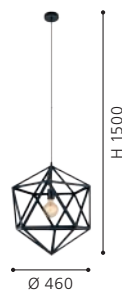

H 1500

Ø 460



DESIGN
 HIGHLIGHT
 DETAIL



49495



49496

49495 LONCINO

pendant light; steel, black / smoked glass, black-transparent
 Hängeleuchte; Stahl, schwarz / Rauchglas, schwarz-transparent
 luminaire en suspension; acier, noir / verre fumé, noir transparent

L 150, B 150, H 1100



E27



1x 60W



9 002759 494957



49496 LONCINO

pendant light; steel, black / smoked glass, black-transparent
 Hängeleuchte; Stahl, schwarz / Rauchglas, schwarz-transparent
 luminaire en suspension; acier, noir / verre fumé, noir transparent

L 745, B 150, H 1100



E27



3x 60W



9 002759 494964





44003



44004

44003 TOOTHILL

wall light; steel, black / glass vaporized, black-transparent
 Wandleuchte; Stahl, schwarz / Glas bedampft, schwarz-transparent
 Applique; acier, noir / verre vaporisé, noir transparent

L 110, H 360, A 130



E27



1x 40W



9 002759 440039



44004 TOOTHILL

floor light; steel, black / glass vaporized, black-transparent
 Stehleuchte; Stahl, schwarz / Glas bedampft, schwarz-transparent
 lampadaire; acier, noir / verre vaporisé, noir transparent

H 1535, Ø 105, Base: Ø 195



E27



1x 40W



9 002759 440046





49392



49394

49392 CHARTERHOUSE

ceiling light; steel, black / glass, clear
Deckenleuchte; Stahl, schwarz / Glas, klar
plafonnier; acier, noir / verre, transparent

L 360, B 360, H 160



E27 2x 60W



9 002759 493929

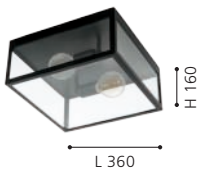

49394 CHARTERHOUSE

wall light; steel, black / glass, clear
Wandleuchte; Stahl, schwarz / Glas, klar
Applique; acier, noir / verre, transparent

L 160, H 280, A 150



E27 1x 60W



9 002759 493943



49393 CHARTERHOUSE

pendant light; steel, black / glass, clear
Hängeleuchte; Stahl, schwarz / Glas, klar
luminaire en suspension; acier, noir / verre, transparent

L 730, B 200, H 1100



E27 3x 60W



9 002759 493936





49393



49564



43365

49564 ELSWICK

pendant light; steel, black
Hängeleuchte; Stahl, schwarz
luminaire en suspension; acier, noir

L 1100, B 250, H 1500



E27 3x 60W



9 002759 495640



L 1100

H 1500

43365 FEMBAR

pendant light; steel, black
Hängeleuchte; Stahl, schwarz
luminaire en suspension; acier, noir

L 1005, B 40, H 1100



E27 7x 60W



9 002759 433659

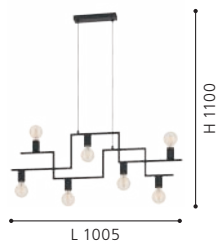

L 1005

H 1100

43126 WILMCOTE

ceiling light; steel, black
Deckenleuchte; Stahl, schwarz
plafonnier; acier, noir

H 380, Ø 280



E27 3x 60W



9 002759 431266



Ø 280

H 380



43126



43522

DESIGN
HIGHLIGHT
DETAIL



43152

43522 TOWNSHEND 4

ceiling light; steel, antique brown
Deckenleuchte; Stahl, antik-braun
plafonnier; acier, marron antique

L 550, B 140, H 260



E27



3x 60W



9 002759 435226

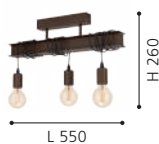

43152 TOWNSHEND 4

wall light; steel, black, brown
Wandleuchte; Stahl, schwarz, braun
Applique; acier, noir, marron

L 80, H 190, A 185



E27



1x 10W



9 002759 431525





43523



43524

DETAIL TOWNSHEND 4

Thanks to the long cable of the luminaire heads the height can be adjusted individually.

Durch das lange Kabel der Leuchtenköpfe kann die Höhe individuell eingestellt werden.

Grâce au long câble des têtes de luminaire la hauteur peut être réglée individuellement.



43523 TOWNSHEND 4

pendant light; steel, antique brown, black
Hängeleuchte; Stahl, antik-braun, schwarz
luminaire en suspension; acier, marron antique, noir

L 700, B 140, H 1100



E27



4x 60W



9 002759 435233



43524 TOWNSHEND 4

pendant light; steel, antique brown, black
Hängeleuchte; Stahl, antik-braun, schwarz
luminaire en suspension; acier, marron antique, noir

L 1500, B 140, H 1100



E27



8x 60W



9 002759 435240

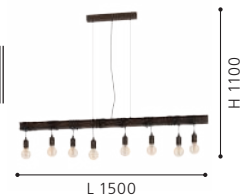



49859



43526



43525

49859 TOWNSHEND 4

pendant light; steel, antique brown, black
Hängeleuchte; Stahl, antik-braun, schwarz
luminaire en suspension; acier, marron antique, noir

L 1005, B 70, H 1100



E27



6x 60W



9 002759 498597

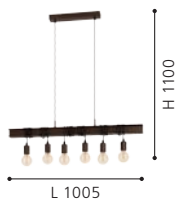

43526 TOWNSHEND 4

floor light; steel, antique brown, black
Stehleuchte; Stahl, antik-braun, schwarz
lampadaire; acier, marron antique, noir

L 260, B 250, H 1690, Base: Ø 250



E27



2x 10W



9 002759 435264



43525 TOWNSHEND 4

table light; steel, antique brown, black
Tischleuchte; Stahl, antik-braun, schwarz
luminaire de table; acier, marron antique, noir

L 165, B 155, H 500, Base: Ø 155



E27



1x 10W



9 002759 435257





43733



43733 PRESTWICK 2

table light; wood, brown
Tischleuchte; Holz, braun
luminaire de table; bois, marron

L 95, B 95, H 95



E27



1x 40W



9 002759 437336





43549



43734



49812

43549 PRESTWICK 2

table light; steel, dark bronze
Tischleuchte; Stahl, bronze dunkel
luminaire de table; acier, bronze foncé

L 100, B 100, H 100



E27 1x 40W



9 002759 435493



L 100

H 100

43734 PRESTWICK 2

table light; wood, black
Tischleuchte; Holz, schwarz
luminaire de table; bois, noir

L 95, B 95, H 95



E27 1x 40W



9 002759 437343



L 95

H 95

49812 PRESTWICK

table light; concrete, grey
Tischleuchte; Beton, grau
luminaire de table; béton, gris

L 90, B 90, H 130



E27 1x 60W



9 002759 498122



L 90

H 130



44091



44093



44091 GATEBECK

spot; wood, natural / steel, black
Spot; Holz, natur / Stahl, schwarz
spot; bois, naturel / acier, noir

L 110, B 110, H 205



E14



1x 40W



9 002759 440916



44093 GATEBECK

spot; wood, natural / steel, black
Spot; Holz, natur / Stahl, schwarz
spot; bois, naturel / acier, noir

L 590, B 110, H 205



E14



3x 40W



9 002759 440930



44092 GATEBECK

spot; wood, natural / steel, black
Spot; Holz, natur / Stahl, schwarz
spot; bois, naturel / acier, noir

L 360, B 110, H 205



E14



2x 40W



9 002759 440923





44092





43956



43956 MACCLES

pendant light; steel, wood, black, brown
Hängeleuchte; Stahl, Holz, schwarz, braun
luminaire en suspension; acier, bois, noir, marron

L 780, B 180, H 1100



E27



3x 15W



9 002759 439569

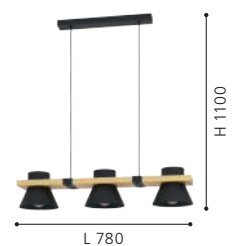



43955



43958



43959



43955 MACCLES

ceiling light; steel, wood, black, brown
Deckenleuchte; Stahl, Holz, schwarz, braun
plafonnier; acier, bois, noir, marron

L 780, B 180, H 205



E27



3x 15W



9 002759 439552



L 780

H 205

43958 MACCLES

wall light; steel, wood, black, brown
Wandleuchte; Stahl, Holz, schwarz, braun
Applique; acier, bois, noir, marron

L 180, H 150, A 200



E27



1x 15W



9 002759 439583

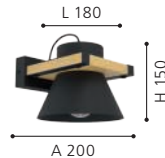

L 180

H 150

A 200

43959 MACCLES

table light; steel, wood, black, brown
Tischleuchte; Stahl, Holz, schwarz, braun
luminaire de table; acier, bois, noir, marron

H 150, Ø 180, Base: B 160, T 160



E27



1x 15W



9 002759 439590

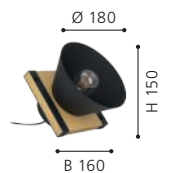

Ø 180

H 150

B 160



43953



43948



43949



43953 CAWTON

table light; steel, wood, steel coloured, rustic brown
Tischleuchte; Stahl, Holz, stahlfarben, braun rustikal
luminaire de table; acier, bois, couleur acier, marron rustique

L 240, B 160, H 380, Base: Ø 180



E27 1x 40W



9 002759 439538



43948 CAWTON

spot; steel, wood, steel coloured, rustic brown
Spot; Stahl, Holz, stahlfarben, braun rustikal
spot; acier, bois, couleur acier, marron rustique

L 160, H 195, A 300



E27 1x 40W



9 002759 439484



43949 CAWTON

spot; steel, wood, steel coloured, rustic brown
Spot; Stahl, Holz, stahlfarben, braun rustikal
spot; acier, bois, couleur acier, marron rustique

L 585, B 160, H 250



E27 2x 40W



9 002759 439491





43954 CAWTON

floor light; steel, wood, steel coloured, rustic brown
 Stehleuchte; Stahl, Holz, stahlfarben, braun rustikal
 lampadaire; acier, bois, couleur acier, marron rustique

L 290, B 160, H 1345, Base: Ø 230



L 290



H 1345

Ø 230



9 002759 439545

43951 CAWTON

pendant light; steel, wood, steel coloured, rustic brown
 Hängeleuchte; Stahl, Holz, stahlfarben, braun rustikal
 luminaire en suspension; acier, bois, couleur acier, marron rustique

H 1100, Ø 160



H 1100

Ø 160



9 002759 439514

43952 CAWTON

pendant light; steel, wood, steel coloured, rustic brown
 Hängeleuchte; Stahl, Holz, stahlfarben, braun rustikal
 luminaire en suspension; acier, bois, couleur acier, marron rustique

L 760, B 160, H 1100



H 1100

L 760



9 002759 439521

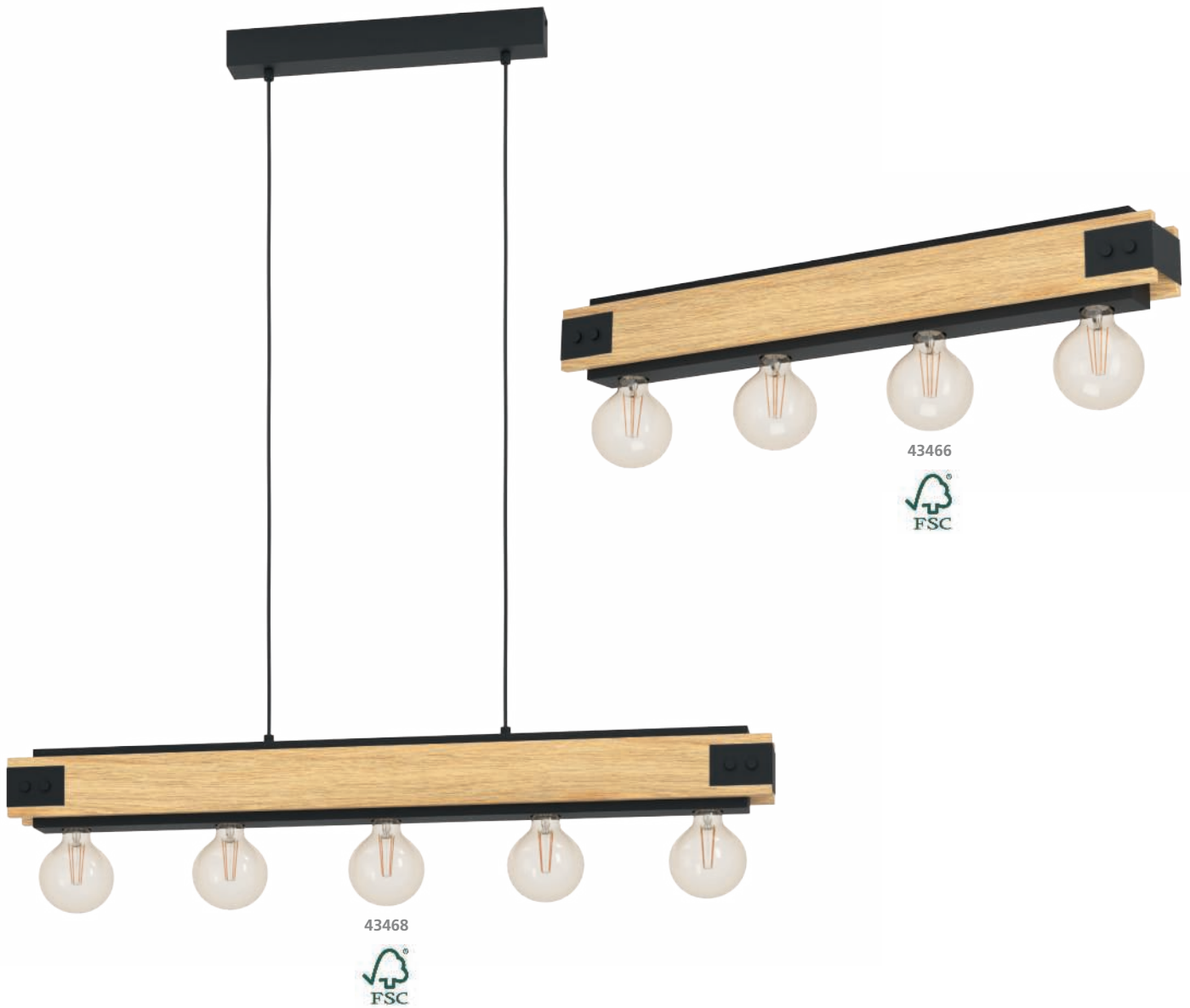

43468 LAYHAM

pendant light; wood, steel, brown, black
 Hängeleuchte; Holz, Stahl, braun, schwarz
 luminaire en suspension; bois, acier, marron, noir

L 960, B 85, H 1100



E27 5x 60W



9 002759 434687

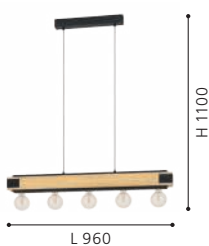

43466 LAYHAM

ceiling light; wood, steel, brown, black
 Deckenleuchte; Holz, Stahl, braun, schwarz
 plafonnier; bois, acier, marron, noir

L 760, B 85, H 100



E27 4x 60W



9 002759 434663

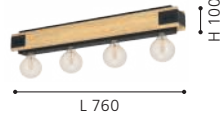

43469 LAYHAM

table light; wood, steel, brown, black
 Tischleuchte; Holz, Stahl, braun, schwarz
 luminaire de table; bois, acier, marron, noir

L 200, B 85, H 100



E27 1x 16W



9 002759 434694

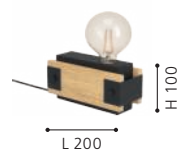



43469





43159



43805

43159 HARBOROUGH

pendant light; steel, black / wood, brown
 Hängeleuchte; Stahl, schwarz / Holz, braun
 luminaire en suspension; acier, noir / bois, marron

L 900, B 125, H 1100



E27 4x 40W



9 002759 431594

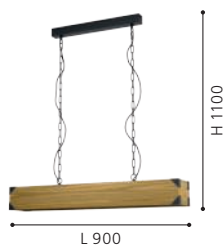

43805 EVESHAM

pendant light; steel, wood, black, brown
 Hängeleuchte; Stahl, Holz, schwarz, braun
 luminaire en suspension; acier, bois, noir, marron

L 895, B 195, H 1100



E27 3x 40W



9 002759 438050

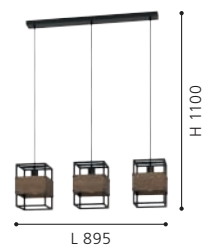



43804 EVESHAM

ceiling light; steel, wood, black, brown
 Deckenleuchte; Stahl, Holz, schwarz, braun
 plafonnier; acier, bois, noir, marron

L 875, B 195, H 250



E27



3x 40W



9 002759 438043



43807 EVESHAM

table light; steel, wood, black, brown
 Tischleuchte; Stahl, Holz, schwarz, braun
 luminaire de table; acier, bois, noir, marron

L 195, B 195, H 250



E27



1x 40W



9 002759 438074



43806 EVESHAM

wall light; steel, wood, black, brown
 Wandleuchte; Stahl, Holz, schwarz, braun
 Applique; acier, bois, noir, marron

L 140, H 240, A 170



E27



1x 40W



9 002759 438067





43832

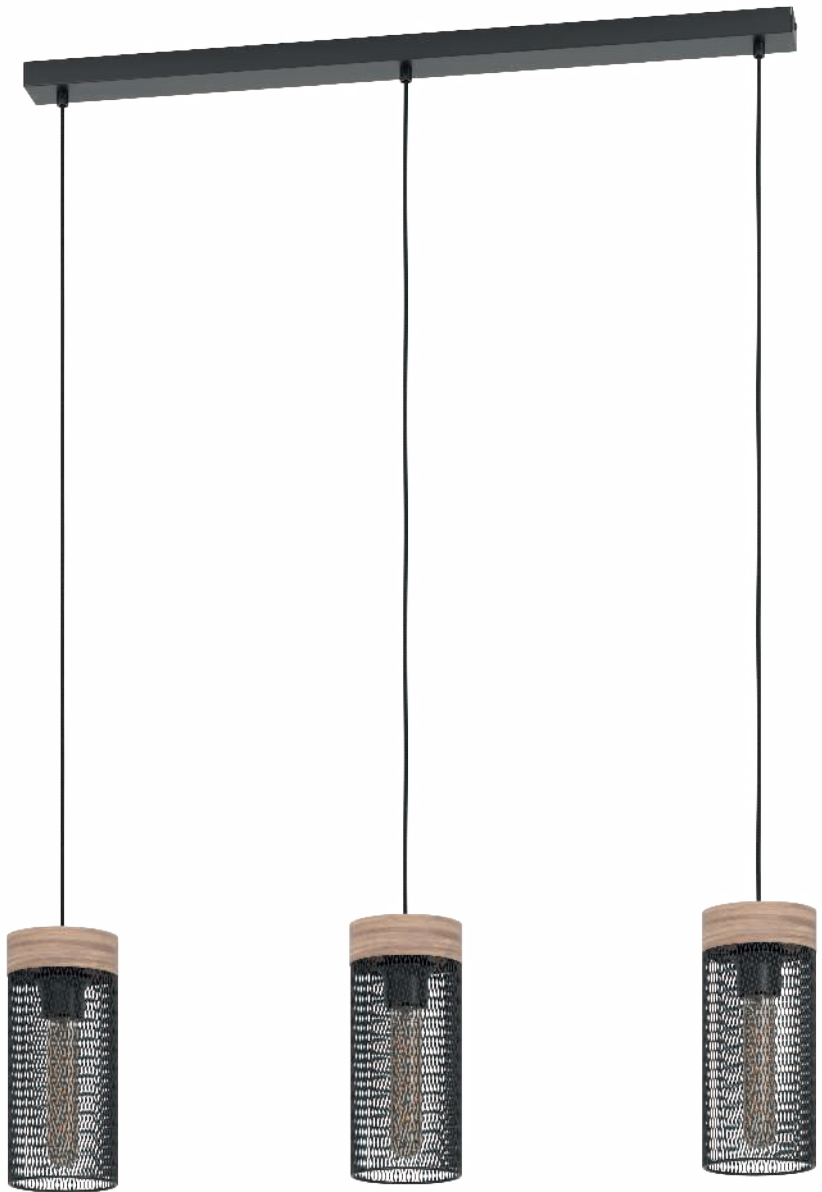

43834

43832 KILNSDALE

ceiling light; steel, wood, black, brown
Deckenleuchte; Stahl, Holz, schwarz, braun
plafonnier; acier, bois, noir, marron

H 240, Ø 380



E27 1x 40W



9 002759 438326

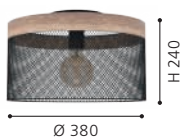

Ø 380

H 240

43834 KILNSDALE

pendant light; steel, wood, black, brown
Hängeleuchte; Stahl, Holz, schwarz, braun
luminaire en suspension; acier, bois, noir, marron

L 810, B 110, H 1100

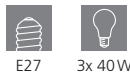

E27 3x 40W



9 002759 438340



L 810

H 1100

43833 KILNSDALE

pendant light; steel, wood, black, brown
Hängeleuchte; Stahl, Holz, schwarz, braun
luminaire en suspension; acier, bois, noir, marron

H 1100, Ø 110



E27 1x 40W



9 002759 438333

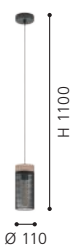

Ø 110

H 1100



43833

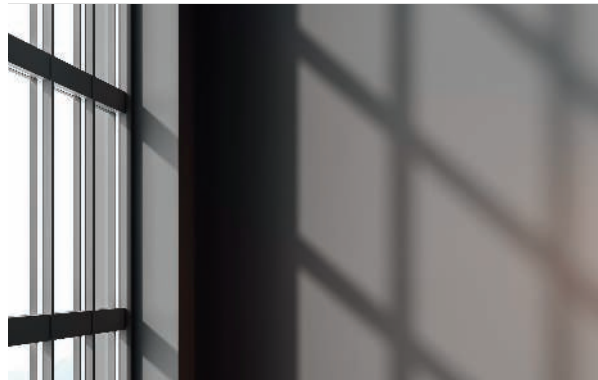

LOFT

#COSY
#CLEAR

Separate rooms and designated spaces for working, eating and leisure are a thing of the past. Free spirits need open spaces. The loft design imparts a sense of freedom and tranquillity, and the minimalist furnishings and accessories ensure your space still feels cosy and liveable. Simple yet sophisticated. Clean lines and dark surfaces offset by brighter accents are the main features of the loft aesthetic. Recreate this chic look in your own home with EGLO.

Die Zeiten in denen Wohnen, Essen und Arbeiten in getrennten Räumen stattfanden, sind vorbei. Freigeister brauchen Freiräume, um sich wohl zu fühlen. Der Loft-Look steht für Freiheit und Gelassenheit, welcher durch minimalistische Möbel und Accessoires trotzdem ein gemütliches Raumgefühl gibt. Einfach und doch raffiniert. Klare Linien, dunkle Oberflächen, kontrastiert von hellen Akzenten sind die Hauptmerkmale des Loft-Looks und mit EGLO holen Sie sich diesen Loft-Charm ganz einfach nach Hause.

Finie l'époque où l'on vivait, mangeait et travaillait dans des pièces distinctes ! Les esprits libres ont besoin d'espace pour se sentir bien. Le style loft est synonyme de liberté et de sérénité, mais donne néanmoins le sentiment d'un espace chaleureux grâce à un mobilier et à des accessoires minimalistes. Simple, mais sophistiqué. Des lignes épurées avec des surfaces foncées, contrastées par des touches claires, sont les principales caractéristiques du style loft. Appropriiez-vous son élégance dans votre intérieur avec EGLO.

HORNWOOD 2 78	BOYLE 80	HORNWOOD 82-83	LACEY 84-85	BRAMERTON 86-87	AYLES 87	CHIEVELEY 88-89	HALKIN 90
CONSETT 90-91	FAMBOROUGH 92-93	NAFFERTON 94-95	LITTLETON 96-97	BASILDON 1 98	BASILDON 98-99	CALLOW 100	SHERBURN 101
BUDDON 102	POCKLEY 102	BAILRIGG 102-103	TOWNSHEND 104-109	TOWNSHEND 5 110-113	PALMORLA 113	CARLTON 1 114-116,120-122	CARLTON 7 116-117
CARLTON 4 118	CARLTON 6 118	CARLTON 5 119	CARLTON-P 122	CARLTON 124-127	STYPE 128-129	STRAITON 130	VERNHAM 133
TARBES 134,146-151	CARLTON 2 134	STILLINGTON 136-137	STILLINGTON 1 138-139	SOUTHERY 140-141	LINTMILL 142	CASTANUELO 144-145	ROCCAMENA 152
CLEVEDON 153	NEWTOWN 154-155	AUSTELL 156	PLIMSOLL 159	WAVERTON 160-161	HORNWOOD 1 162	BIDFORD 163	LANTADA 163
CHESTER 164	CHESTER 1 164	CORETTO 2 165	HAPTON 165	COPLEY 166-167	WRINGTON 168-169	POMPEYA 171	WRINGTON 1 171
BAZELY 173	SALLICANO 173	TWICKEN 174-175	MATLOCK 176-179				



This product is available in different colors and shapes./ Dieser Artikel ist in unterschiedlichen Farben und Formen verfügbar.
Cet article est disponible en différentes couleurs et formes.

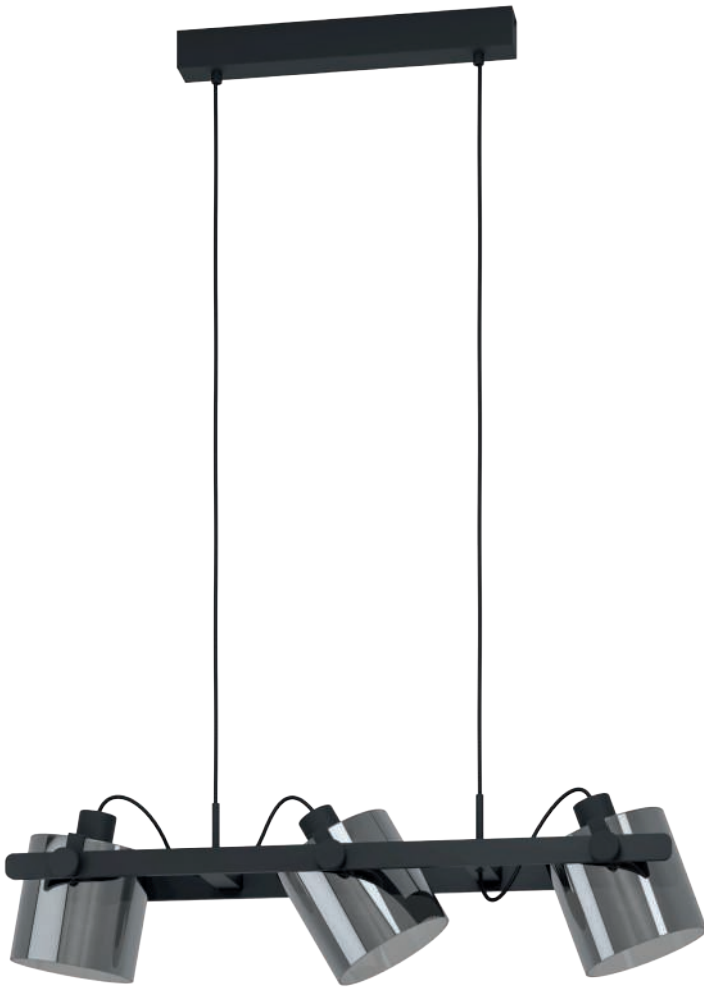

43606



DETAIL HORNWOOD 2

The heads of this luminaire can be swiveled individually.

Die Leuchtenköpfe sind individuell schwenkbar.

Les têtes de ce luminaire peuvent être pivotées individuellement.



43606 HORNWOOD 2

pendant light; steel, wood, black / glass vaporized, black-transparent

Hängeleuchte; Stahl, Holz, schwarz / Glas bedampft, schwarz-transparent

luminaire en suspension; acier, bois, noir / verre vaporisé, noir transparent

L 780, B 150, H 1100



E27



3x 40W



9 002759 436063

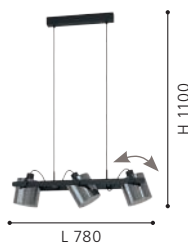

43671 HORNWOOD 2

ceiling light; steel, wood, black / glass vaporized, black-transparent

Deckenleuchte; Stahl, Holz, schwarz / Glas bedampft, schwarz-transparent

plafonnier; acier, bois, noir / verre vaporisé, noir transparent

L 1110, B 225, H 265



E27



4x 40W



9 002759 436711

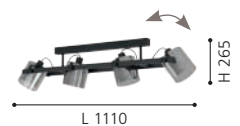



43671





43635



43635 BOYLE

ceiling light; steel, wood, black, brown / plastic, white
Deckenleuchte; Stahl, Holz, schwarz, braun / Kunststoff, weiss
plafonnier; acier, bois, noir, marron / plastique, blanc

L 780, B 170, H 300



E27



3x 10W



9 002759 436353



L 780

H 300

43636 BOYLE

pendant light; steel, wood, black, brown / plastic, white
Hängeleuchte; Stahl, Holz, schwarz, braun / Kunststoff, weiss
luminaire en suspension; acier, bois, noir, marron / plastique, blanc

L 780, B 170, H 1100



E27



3x 10W



9 002759 436360



L 780

H 1100



43636





43517



43424



DETAIL HORNWOOD

The heads can be adjusted or fixed in position with the lateral screws.

Die Köpfe können mittels den seitlichen Schrauben verstellt oder fixiert werden.

Les têtes peuvent être réglées ou fixées à l'aide des vis latérales.



43518



43517 HORNWOOD

pendant light; steel, black, creme / wood, brown
Hängeleuchte; Stahl, schwarz, creme / Holz, braun
luminaire en suspension; acier, noir, crème / bois, marron

L 780, B 210, H 1100



E27



3x 60W



9 002759 435172

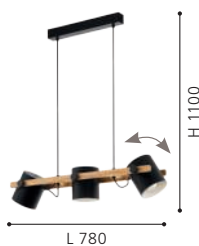

43424 HORNWOOD

pendant light; steel, black, creme / wood, brown
Hängeleuchte; Stahl, schwarz, creme / Holz, braun
luminaire en suspension; acier, noir, crème / bois, marron

L 1100, B 180, H 1100



E27



4x 28W



9 002759 434243

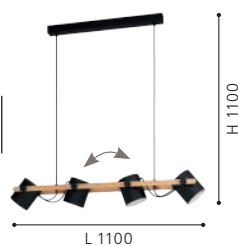

43518 HORNWOOD

wall light; steel, black, creme / wood, brown
Wandleuchte; Stahl, schwarz, creme / Holz, braun
applique; acier, noir, crème / bois, marron

Ø 170



E27



1x 28W



9 002759 435189



Ø 170



43558



43519



43521



43558 HORNWOOD

ceiling light; steel, black, creme / wood, brown
Deckenleuchte; Stahl, schwarz, creme / Holz, braun
plafonnier; acier, noir, crème / bois, marron

L 1000, B 190, H 275



E27



4x 28W



9 002759 435585

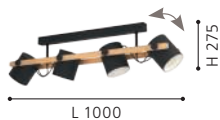

43519 HORNWOOD

table light; steel, black, creme / wood, brown
Tischleuchte; Stahl, schwarz, creme / Holz, braun
luminaire de table; acier, noir, crème / bois, marron

L 210, B 180, H 420, Base: Ø 180



E27



1x 28W



9 002759 435196



43521 HORNWOOD

floor light; steel, black, creme / wood, brown
Stehleuchte; Stahl, schwarz, creme / Holz, braun
lampadaire; acier, noir, crème / bois, marron

L 230, B 230, H 1400, Base: Ø 230



E27



1x 28W



9 002759 435219

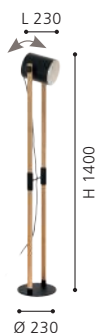



43735



43612



LACEY

These luminaires have design elements made of real wood.

Diese Leuchten verfügen über Design-elemente aus Echtholz.

Ces luminaires disposent d'éléments de design en bois véritable.

43735 LACEY

wall light; steel, wood, black, brown / steel, black, creme
Wandleuchte; Stahl, Holz, schwarz, braun / Stahl, schwarz, creme
Applique; acier, bois, noir, marron / acier, noir, crème

L 135, H 275, A 265



E14



1x 40W



9 002759 437350



43612 LACEY

pendant light; steel, wood, black, brown / steel, black, creme
Hängeleuchte; Stahl, Holz, schwarz, braun / Stahl, schwarz, creme
luminaire en suspension; acier, bois, noir, marron / acier, noir, crème

L 780, B 160, H 1100



E27



3x 40W



9 002759 436124





43611



43613



43614



43611 LACEY

ceiling light; steel, wood, black, brown / steel, black, creme
Deckenleuchte; Stahl, Holz, schwarz, braun / Stahl, schwarz, creme
plafonnier; acier, bois, noir, marron / acier, noir, crème

L 780, B 160, H 335



E27



3x 40W



9 002759 436117



L 780

H 335

43613 LACEY

table light; steel, wood, black, brown / steel, black, creme
Tischleuchte; Stahl, Holz, schwarz, braun / Stahl, schwarz, creme
luminaire de table; acier, bois, noir, marron / acier, noir, crème

L 255, B 135, H 485, Base: B 170, T 120



E14



1x 40W



9 002759 436131



L 255

H 485

B 170

43614 LACEY

floor light; steel, wood, black, brown / steel, black, creme
Stehleuchte; Stahl, Holz, schwarz, braun / Stahl, schwarz, creme
lampadaire; acier, bois, noir, marron / acier, noir, crème

L 310, B 160, H 1595, Base: B 280, T 200



E27



1x 40W



9 002759 436148

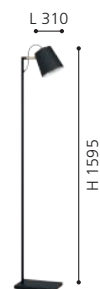

L 310

H 1595

B 280



43752 BRAMERTON

pendant light; steel, wood, black, brown
 Hängeleuchte; Stahl, Holz, schwarz, braun
 luminaire en suspension; acier, bois, noir, marron

L 810, B 120, H 1100

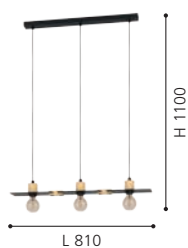

43751 BRAMERTON

ceiling light; steel, wood, black, brown
 Deckenleuchte; Stahl, Holz, schwarz, braun
 plafonnier; acier, bois, noir, marron

L 810, B 120, H 100

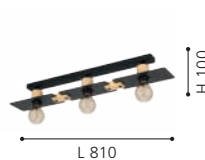

43753 BRAMERTON

wall light; steel, wood, black, brown
 Wandleuchte; Stahl, Holz, schwarz, braun
 Applique; acier, bois, noir, marron

L 120, H 110, A 215

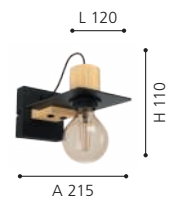



43749

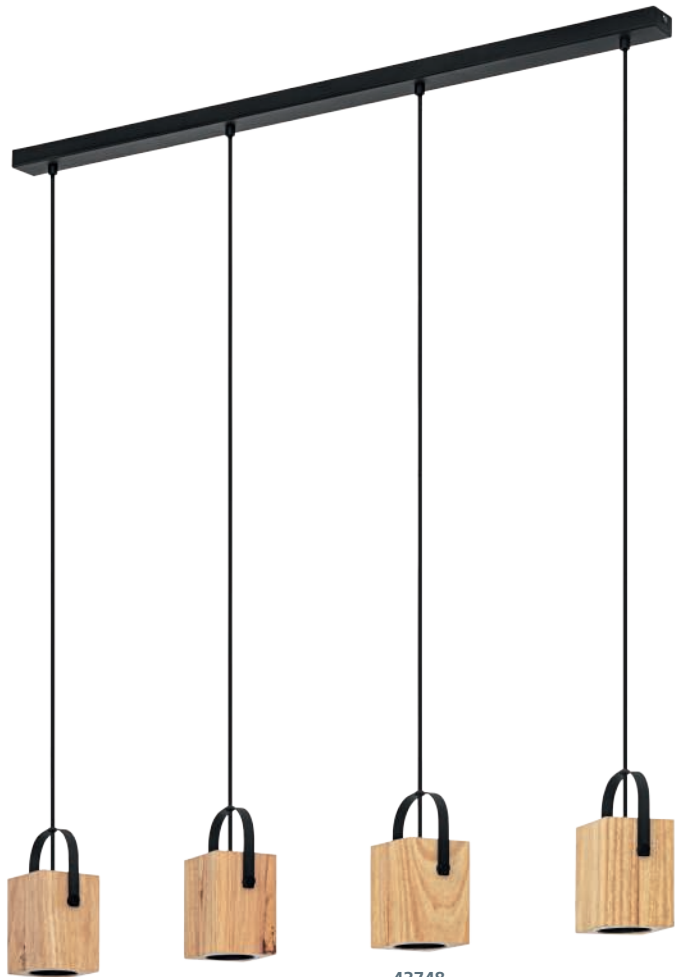

43748



43754



43754 BRAMERTON

table light; steel, wood, black, brown
Tischleuchte; Stahl, Holz, schwarz, braun
luminaire de table; acier, bois, noir, marron

L 120, B 140, H 310, Base: B 120, T 140



E27



1x 40W



9 002759 437541



43749 AYLES

table light; steel, black / wood, brown
Tischleuchte; Stahl, schwarz / Holz, braun
luminaire de table; acier, noir / bois, marron

H 475, Base: Ø 260



GU10



1x 3W



warm
WHITE
1x
250lm



9 002759 437497



43748 AYLES

pendant light; steel, black / wood, brown
Hängeleuchte; Stahl, schwarz / Holz, braun
luminaire en suspension; acier, noir / bois, marron

L 930, B 85, H 1100



GU10



4x 3W



warm
WHITE
4x
250lm



9 002759 437480

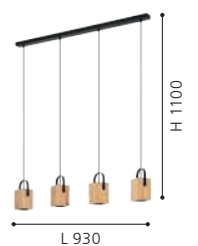



43541

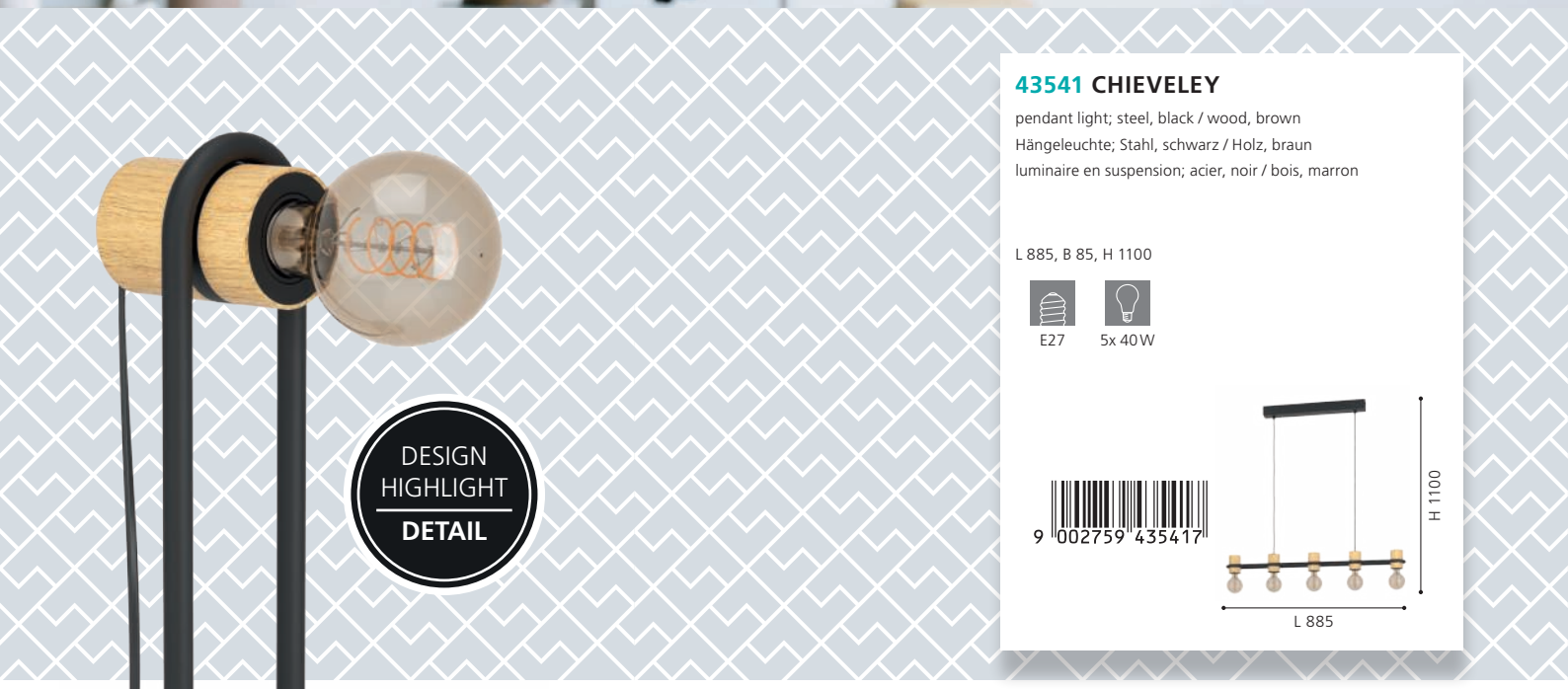

DESIGN
HIGHLIGHT
DETAIL

43541 CHIEVELEY

pendant light; steel, black / wood, brown
Hängeleuchte; Stahl, schwarz / Holz, braun
luminaire en suspension; acier, noir / bois, marron

L 885, B 85, H 1100



E27



5x 40W



9 002759 435417

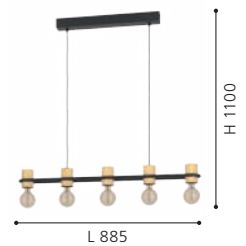



43542



43543

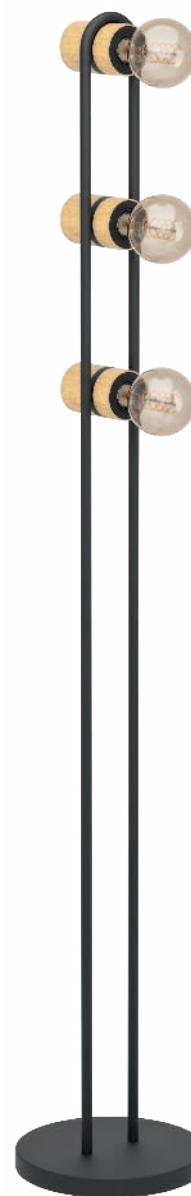

43544



43542 CHIEVELEY

wall light; steel, black / wood, brown
Wandleuchte; Stahl, schwarz / Holz, braun
Applique; acier, noir / bois, marron

L 285, H 90, A 115



E27



2x 40W



9 002759 435424

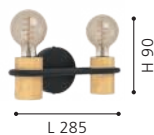

43543 CHIEVELEY

table light; steel, black / wood, brown
Tischleuchte; Stahl, schwarz / Holz, braun
luminaire de table; acier, noir / bois, marron

L 85, B 90, H 410, Base: Ø 155



E27



1x 28W



9 002759 435431



43544 CHIEVELEY

floor light; steel, black / wood, brown
Stehleuchte; Stahl, schwarz / Holz, braun
lampadaire; acier, noir / bois, marron

L 85, B 90, H 1405, Base: Ø 230



E27



3x 28W



9 002759 435448

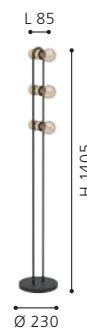

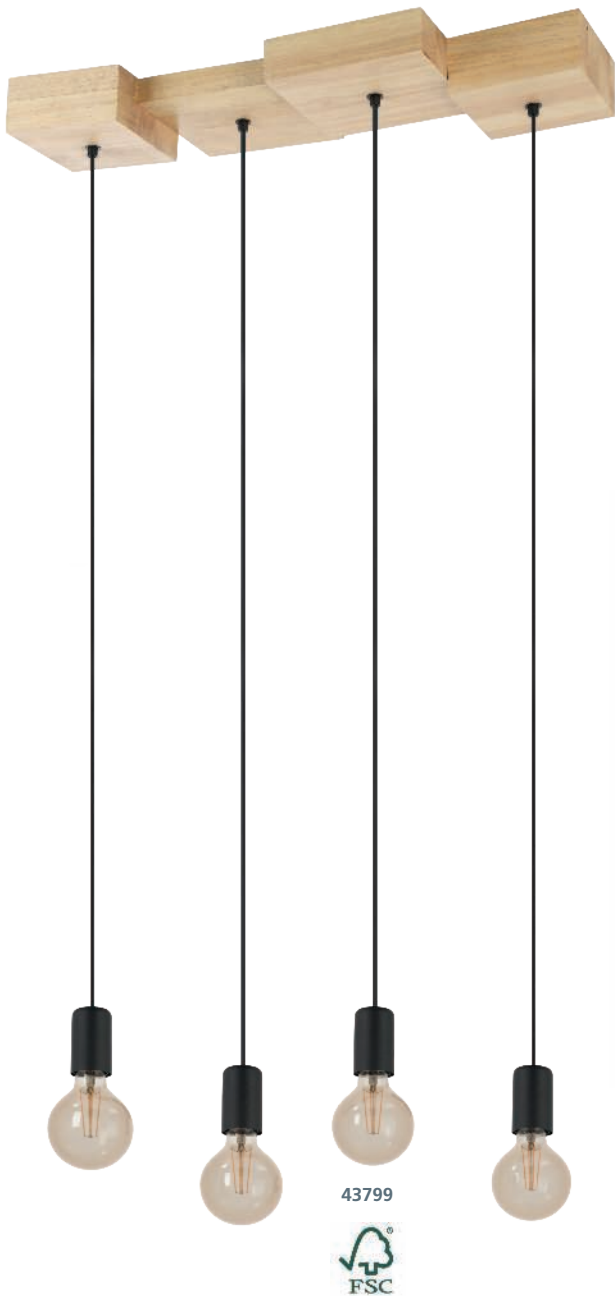

43799



43798



43724



43799 HALKIN

pendant light; wood, steel, brown, black
 Hängeleuchte; Holz, Stahl, braun, schwarz
 luminaire en suspension; bois, acier, marron, noir

L 720, B 250, H 1100



E27 4x 40W



9 002759 437992

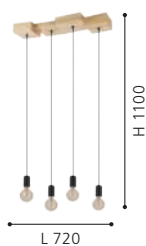

43798 HALKIN

ceiling light; wood, steel, brown, black
 Deckenleuchte; Holz, Stahl, braun, schwarz
 plafonnier; bois, acier, marron, noir

L 400, B 430, H 140



E27 4x 40W



9 002759 437985

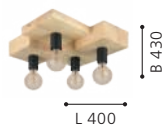

43724 CONSETT

ceiling light; steel, wood, black, brown
 Deckenleuchte; Stahl, Holz, schwarz, braun
 plafonnier; acier, bois, noir, marron

L 780, B 250, H 115



E27 6x 40W



9 002759 437244

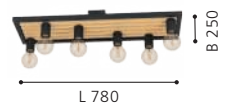



43725



43725 CONSETT

pendant light; steel, wood, black, brown
 Hängeleuchte; Stahl, Holz, schwarz, braun
 luminaire en suspension; acier, bois, noir, marron

L 780, B 250, H 1100



E27



6x 40W



9 002759 437251

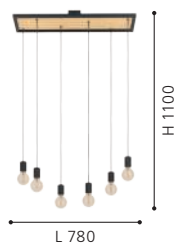

H 1100

L 780

DESIGN
HIGHLIGHT
DETAIL



43413



43413 FAMBOROUGH

pendant light; steel, wood, black, natural
Hängeleuchte; Stahl, Holz, schwarz, natur
luminaire en suspension; acier, bois, noir, naturel

L 160, B 105, H 1100



E27



1x 40W



9 002759 434137

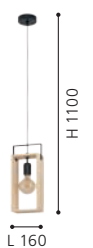



43414



43416



43415



43414 FAMBOROUGH

pendant light; steel, wood, black, natural
Hängeleuchte; Stahl, Holz, schwarz, natur
luminaire en suspension; acier, bois, noir, naturel

L 1000, B 160, H 1100



E27

5x 40W



9 002759 434144

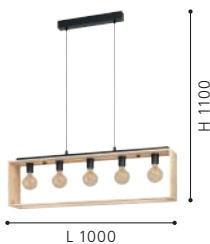

43416 FAMBOROUGH

table light; steel, wood, black, natural
Tischleuchte; Stahl, Holz, schwarz, natur
luminaire de table; acier, bois, noir, naturel

L 305, B 160, H 565, Base: B 300, T 160



E27

3x 40W



9 002759 434168



43415 FAMBOROUGH

table light; steel, wood, black, natural
Tischleuchte; Stahl, Holz, schwarz, natur
luminaire de table; acier, bois, noir, naturel

L 165, B 100, H 400, Base: B 160, T 100



E27

1x 40W



9 002759 434151





43744



43744 NAFFERTON

pendant light; steel, wood, black, brown
Hängeleuchte; Stahl, Holz, schwarz, braun
luminaire en suspension; acier, bois, noir, marron

L 800, B 100, H 1100



E27



3x 40W



9 002759 437442





43743



43746



43745



43743 NAFFERTON

pendant light; steel, wood, black, brown
Hängeleuchte; Stahl, Holz, schwarz, braun
luminaire en suspension; acier, bois, noir, marron

L 100, B 100, H 1100



E27



1x 40W



9 002759 437435



43746 NAFFERTON

table light; steel, wood, black, brown
Tischleuchte; Stahl, Holz, schwarz, braun
luminaire de table; acier, bois, noir, marron

L 100, B 100, H 280



E27



1x 40W



9 002759 437466



43745 NAFFERTON

wall light; steel, wood, black, brown
Wandleuchte; Stahl, Holz, schwarz, braun
Applique; acier, bois, noir, marron

L 100, H 280, A 125



E27



1x 40W



9 002759 437459

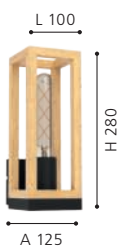

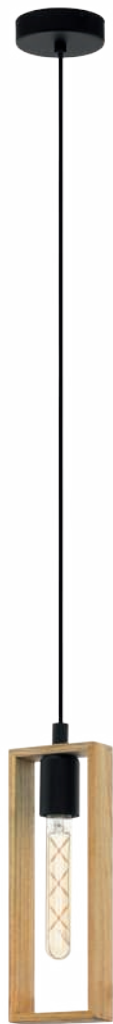

44051



44053



44051 LITTLETON

pendant light; steel, black / wood, brown
Hängeleuchte; Stahl, schwarz / Holz, braun
luminaire en suspension; acier, noir / bois, marron

L 110, B 100, H 1100



E27



1x 40W



9 002759 440510



44053 LITTLETON

pendant light; steel, black / wood, brown
Hängeleuchte; Stahl, schwarz / Holz, braun
luminaire en suspension; acier, noir / bois, marron

L 1160, B 55, H 1100



E27



4x 40W



9 002759 440534





44055



44054



44055 LITTLETON

wall light; steel, black / wood, brown
 Wandleuchte; Stahl, schwarz / Holz, braun
 Applique; acier, noir / bois, marron

L 110, H 330, A 115



E27



1x 40W



9 002759 440558

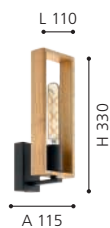

44054 LITTLETON

pendant light; steel, black / wood, brown
 Hängeleuchte; Stahl, schwarz / Holz, braun
 luminaire en suspension; acier, noir / bois, marron

H 1500, Ø 500



E27



6x 40W



9 002759 440541





DETAIL BASILDON

The black metal ring is individually adjustable.
Der schwarze Metallring ist individuell verstellbar.
L'anneau en métal noir est réglable individuellement.



43569



43461



43462



43569 BASILDON 1

table light; steel, wood, black, brown / fabric, black
Tischleuchte; Stahl, Holz, schwarz, braun / Textil, schwarz
luminaire de table; acier, bois, noir, marron / tissu, noir

H 425, Ø 230, Base: Ø 150



E27 1x 40W



9 002759 435691



43461 BASILDON

pendant light; steel, wood, black, brown
Hängeleuchte; Stahl, Holz, schwarz, braun
luminaire en suspension; acier, bois, noir, marron

L 190, B 160, H 1100



E27 1x 40W



9 002759 434618



43462 BASILDON

pendant light; steel, wood, black, brown
Hängeleuchte; Stahl, Holz, schwarz, braun
luminaire en suspension; acier, bois, noir, marron

L 780, B 160, H 1100



E27 3x 40W



9 002759 434625

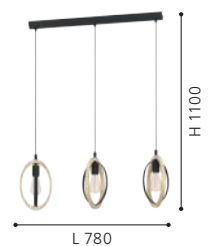



43736



43464



43463



43736 BASILDON

ceiling light; steel, wood, black, brown
Deckenleuchte; Stahl, Holz, schwarz, braun
plafonnier; acier, bois, noir, marron

H 375, Ø 320



E27



1x 40W



9 002759 437367

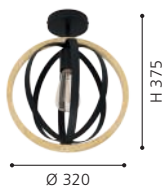

43464 BASILDON

table light; steel, wood, black, brown
Tischleuchte; Stahl, Holz, schwarz, braun
luminaire de table; acier, bois, noir, marron

L 190, B 160, H 345, Base: Ø 155



E27



1x 40W



9 002759 434649



43463 BASILDON

pendant light; steel, wood, black, brown
Hängeleuchte; Stahl, Holz, schwarz, braun
luminaire en suspension; acier, bois, noir, marron

H 1300, Ø 615



E27



3x 40W



9 002759 434632





43756

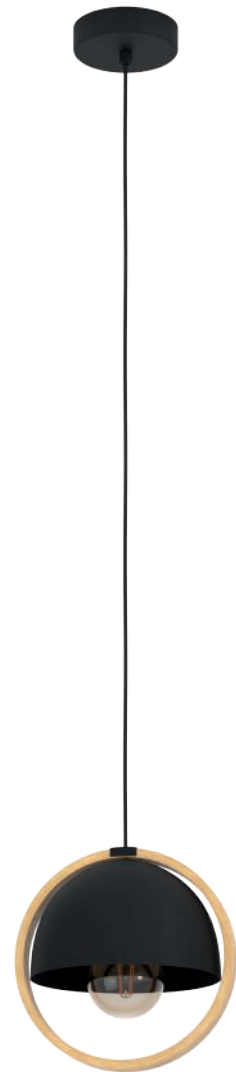

43755



43756 CALLOW

pendant light; steel, wood, black, brown
 Hängeleuchte; Stahl, Holz, schwarz, braun
 luminaire en suspension; acier, bois, noir, marron

L 930, B 230, H 1100



E27



3x 40W



9 002759 437565



43755 CALLOW

pendant light; steel, wood, black, brown
 Hängeleuchte; Stahl, Holz, schwarz, braun
 luminaire en suspension; acier, bois, noir, marron

H 1100, Ø 230



E27



1x 40W



9 002759 437558





43739 SHERBURN

pendant light; steel, wood, black, brown
 Hängeleuchte; Stahl, Holz, schwarz, braun
 luminaire en suspension; acier, bois, noir, marron

L 770, B 200, H 1100



E27



3x 40W



9 002759 437398



43738 SHERBURN

ceiling light; steel, wood, black, brown
 Deckenleuchte; Stahl, Holz, schwarz, braun
 plafonnier; acier, bois, noir, marron

L 800, B 200, H 255



E27



3x 40W



9 002759 437381



DETAIL 43898, 44013



These wall luminaires are easily adjustable using the cable wrap or the adjustable rod. No wall outlet is required for installation, just a socket below the luminaires.

Diese Wandleuchten sind einfach verstellbar mit Hilfe der Wickelung des Kabels bzw. des verstellbaren Stabes. Für die Montage ist kein Wandauslas notwendig, sondern nur eine Steckdose unterhalb der Leuchten.

Ces appliques sont facilement réglables à l'aide de l'enroulement du câble ou de la tige réglable. Pour le montage, il n'est pas nécessaire de prévoir une sortie murale, mais seulement une prise de courant sous le luminaire.



43898



44013



43904



43898 BUDDON

wall light; wood, steel, brown, black
Wandleuchte; Holz, Stahl, braun, schwarz
Applique; bois, acier, marron, noir

L 55, H 2600, A 80



E27 1x 13W



9 002759 438982

44013 POCKLEY

wall light; wood, steel, brown, black
Wandleuchte; Holz, Stahl, braun, schwarz
Applique; bois, acier, marron, noir

L 45, H 295, A 160



E27 1x 10W



9 002759 440138

43904 BAILRIGG

table light; steel, wood, black, brown
Tischleuchte; Stahl, Holz, schwarz, braun
luminaire de table; acier, bois, noir, marron

L 65, B 45, H 330, Base: B 130, T 80



E27 1x 40W



9 002759 439040



43901



43903



43902



43903 BAILRIGG

wall light; steel, wood, black, brown
Wandleuchte; Stahl, Holz, schwarz, braun
Applique; acier, bois, noir, marron

L 55, H 135, A 140



E27



1x 40W



9 002759 439033

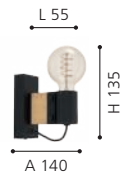

43901 BAILRIGG

ceiling light; steel, wood, black, brown
Deckenleuchte; Stahl, Holz, schwarz, braun
plafonnier; acier, bois, noir, marron

L 655, B 100, H 45



E27



3x 40W



9 002759 439019

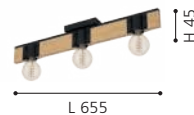

43902 BAILRIGG

pendant light; steel, wood, black, brown
Hängeleuchte; Stahl, Holz, schwarz, braun
luminaire en suspension; acier, bois, noir, marron

L 895, B 45, H 1100



E27



4x 40W



9 002759 439026

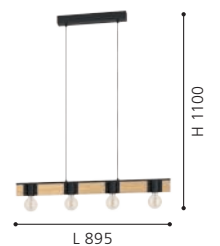



43704



43705



43704 TOWNSHEND

pendant light; steel, white / wood, brown
 Hängeleuchte; Stahl, weiss / Holz, braun
 luminaire en suspension; acier, blanc / bois, marron

L 700, B 105, H 1100



E27



4x 60W



9 002759 437046



43705 TOWNSHEND

pendant light; steel, white / wood, brown
 Hängeleuchte; Stahl, weiss / Holz, braun
 luminaire en suspension; acier, blanc / bois, marron

L 1000, B 100, H 1100



E27



6x 60W



9 002759 437053

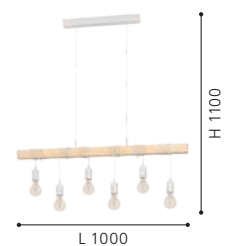



43706



44082



33163

43706 TOWNSHEND

wall light; steel, white / wood, brown
Wandleuchte; Stahl, weiss / Holz, braun
Applique; acier, blanc / bois, marron

L 65, H 215, A 185



E27



1x 10W



9 002759 437060



44082 TOWNSHEND

ceiling light; steel, white / wood, brown
Deckenleuchte; Stahl, weiss / Holz, braun
plafonnier; acier, blanc / bois, marron

L 550, B 105, H 265



E27



3x 60W



9 002759 440824

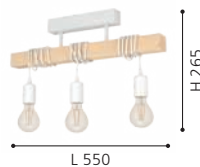

33163 TOWNSHEND

table light; steel, white / wood, brown
Tischleuchte; Stahl, weiss / Holz, braun
luminaire de table; acier, blanc / bois, marron

L 175, B 155, H 500, Base: Ø 155



E27



1x 10W



9 002759 331634

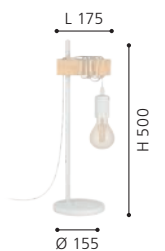



43513



44099



DETAIL TOWNSHEND

Thanks to the long cable of the luminaire heads, the height can be adjusted individually.

Durch das lange Kabel der Leuchtenköpfe kann die Höhe individuell eingestellt werden.

Grâce au long câble des têtes de luminaire, la hauteur peut être réglée individuellement.



43513 TOWNSHEND

pendant light; steel, wood, black, brown
Hängeleuchte; Stahl, Holz, schwarz, braun
luminaire en suspension; acier, bois, noir, marron

L 1000, B 100, H 1100



E27



6x 60W



9 002759 435134

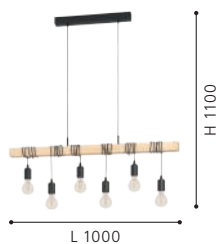

44099 TOWNSHEND

pendant light; wood, steel, brown, black
Hängeleuchte; Holz, Stahl, braun, schwarz
luminaire en suspension; bois, acier, marron, noir

L 1500, B 100, H 1100



E27



9x 60W



9 002759 440992

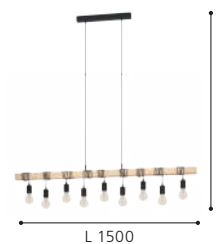

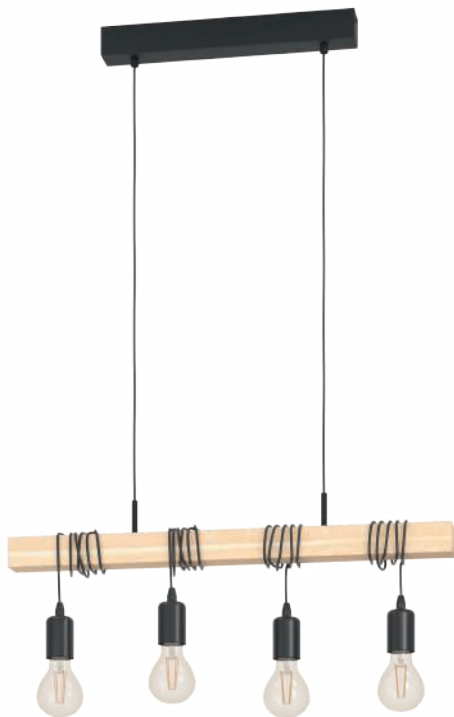

43512



43511



43512 TOWNSHEND

pendant light; steel, wood, black, brown
 Hängeleuchte; Stahl, Holz, schwarz, braun
 luminaire en suspension; acier, bois, noir, marron

L 700, B 105, H 1100



E27



4x 60W



9 002759 435127



43511 TOWNSHEND

ceiling light; steel, wood, black, brown
 Deckenleuchte; Stahl, Holz, schwarz, braun
 plafonnier; acier, bois, noir, marron

L 550, B 105, H 265



E27



3x 60W



9 002759 435110

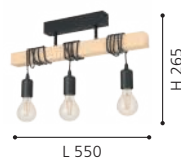

DESIGN
HIGHLIGHT
DETAIL



43514 TOWNSHEND

wall light; steel, wood, black, brown
Wandleuchte; Stahl, Holz, schwarz, braun
Applique; acier, bois, noir, marron

L 65, H 215, A 190

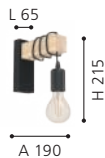

43515 TOWNSHEND

table light; steel, wood, black, brown
Tischleuchte; Stahl, Holz, schwarz, braun
luminaire de table; acier, bois, noir, marron

L 175, B 155, H 500, Base: Ø 155



43516 TOWNSHEND

floor light; steel, wood, black, brown
Stehleuchte; Stahl, Holz, schwarz, braun
lampadaire; acier, bois, noir, marron

L 205, B 250, H 1665, Base: Ø 250





44062



44062 TOWNSHEND

pendant light; steel, black / wood, black
Hängeleuchte; Stahl, schwarz / Holz, schwarz
luminaire en suspension; acier, noir / bois, noir

L 1000, B 100, H 1100



E27



6x 40W



9 002759 440626

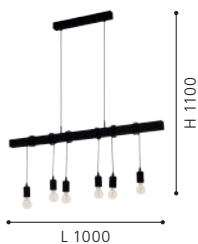



44074



44075



44074 TOWNSHEND 5

ceiling light; steel, wood, black, brown
Deckenleuchte; Stahl, Holz, schwarz, braun
plafonnier; acier, bois, noir, marron

L 550, B 200, H 360



E27



3x 60W



9 002759 440749



L 550

H 360

44075 TOWNSHEND 5

pendant light; steel, wood, black, brown
Hängeleuchte; Stahl, Holz, schwarz, braun
luminaire en suspension; acier, bois, noir, marron

L 700, B 200, H 1100



E27



4x 60W



9 002759 440756

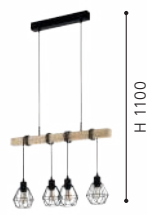

L 700

H 1100

44078 TOWNSHEND 5

wall light; steel, wood, black, brown
Wandleuchte; Stahl, Holz, schwarz, braun
Applique; acier, bois, noir, marron

L 140, H 275, A 240



E27



1x 60W



9 002759 440787

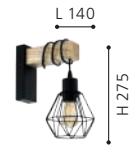

A 240

H 275



44078





44076



44077



DETAIL TOWNSHEND 5

Thanks to the long cable of the luminaire heads, the height can be adjusted individually.

Durch das lange Kabel der Leuchtenköpfe kann die Höhe individuell eingestellt werden.

Grâce au long câble des têtes de luminaire, la hauteur peut être réglée individuellement.

44076 TOWNSHEND 5

pendant light; steel, wood, black, brown
Hängeleuchte; Stahl, Holz, schwarz, braun
luminaire en suspension; acier, bois, noir, marron

L 1000, B 200, H 1100



E27



6x 60W



9 002759 440763



44077 TOWNSHEND 5

pendant light; steel, wood, black, brown
Hängeleuchte; Stahl, Holz, schwarz, braun
luminaire en suspension; acier, bois, noir, marron

L 1500, B 200, H 1100



E27



9x 60W



9 002759 440770

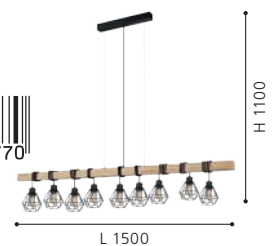



44081



44079



44094



44081 TOWNSHEND 5

floor light; steel, wood, black, brown
 Stehleuchte; Stahl, Holz, schwarz, braun
 lampadaire; acier, bois, noir, marron

L 400, B 250, H 1665, Base: Ø 250



E27 2x 60W



9 002759 440817

44079 TOWNSHEND 5

table light; steel, wood, black, brown
 Tischleuchte; Stahl, Holz, schwarz, braun
 luminaire de table; acier, bois, noir, marron

L 220, B 155, H 500, Base: Ø 155



E27 1x 60W



9 002759 440794

44094 PALMORLA

pendant light; steel, wood, black, brown
 Hängeleuchte; Stahl, Holz, schwarz, braun
 luminaire en suspension; acier, bois, noir, marron

L 760, B 160, H 1100



E27 3x 60W



9 002759 440947

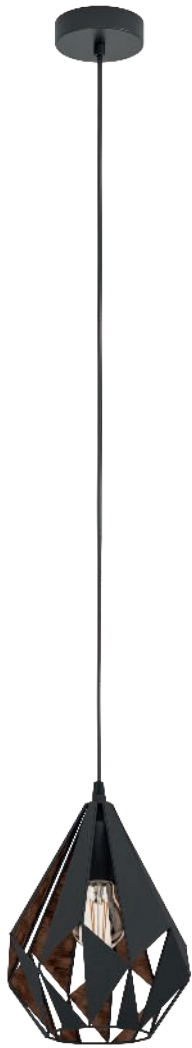

49997

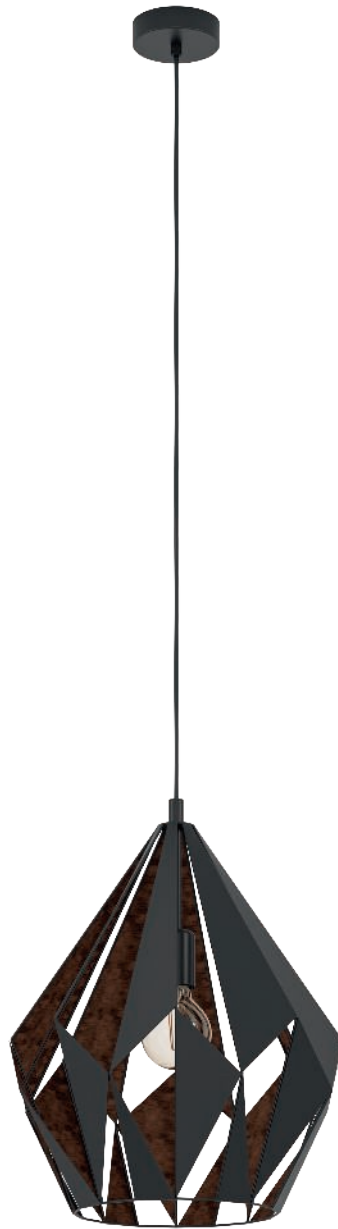

49878

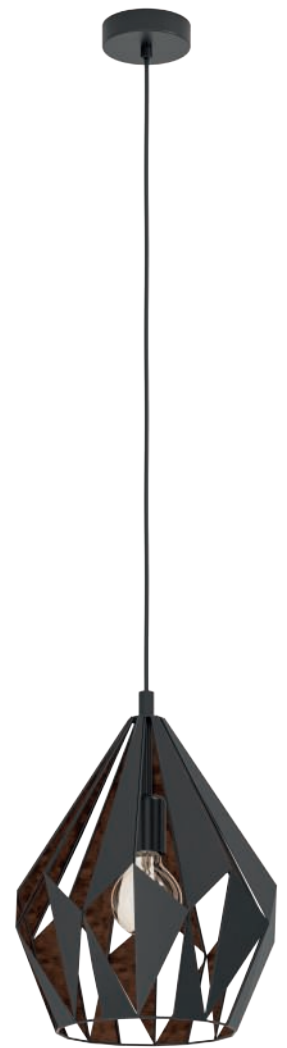

49254

49997 CARLTON 1

pendant light; steel, black, copper
Hängeleuchte; Stahl, schwarz, kupfer
luminaire en suspension; acier, noir, cuivre

H 1100, Ø 205



E27 1x 60W



9 002759 499976

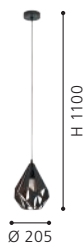

49878 CARLTON 1

pendant light; steel, black, copper
Hängeleuchte; Stahl, schwarz, kupfer
luminaire en suspension; acier, noir, cuivre

H 1500, Ø 385



E27 1x 60W



9 002759 498788



49254 CARLTON 1

pendant light; steel, black, copper
Hängeleuchte; Stahl, schwarz, kupfer
luminaire en suspension; acier, noir, cuivre

H 1100, Ø 310



E27 1x 60W



9 002759 492540





49991



49994



49992

DETAIL 49992

This wall luminaires can be mounted with the head up and down.

Diese Wandleuchten können mit dem Kopf nach oben und unten montiert werden.

Cette appliques peuvent être montée avec la tête en haut ou en bas.



49991 CARLTON 1

pendant light; steel, black, copper
Hängeleuchte; Stahl, schwarz, kupfer
luminaire en suspension; acier, noir, cuivre

L 805, B 205, H 1100



E27 3x 60W



9 002759 499914



49994 CARLTON 1

floor light; steel, black, copper
Stehleuchte; Stahl, schwarz, kupfer
lampadaire; acier, noir, cuivre

H 1525, Ø 255, Base: Ø 230



E27 1x 60W



9 002759 499945

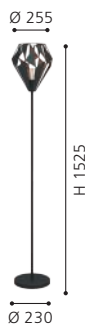

49992 CARLTON 1

wall light; steel, black, copper
Wandleuchte; Stahl, schwarz, kupfer
Applique; acier, noir, cuivre

L 205, H 330, A 220



E27 1x 60W



9 002759 499921





43846



43716

43846 CARLTON 1

pendant light; steel, black, copper
Hängeleuchte; Stahl, schwarz, kupfer
luminaire en suspension; acier, noir, cuivre

L 1455, B 385, H 1070



E27



6x 40W



9 002759 438463



L 1455

H 1070

43716 CARLTON 7

spot; steel, black, antique copper coloured
Spot; Stahl, schwarz, kupferfarben-antik
spot; acier, noir, aspect cuivre-antique

L 420, B 160, H 255



E27



2x 40W



9 002759 437169



L 420

H 255



43717



43718



43715

43717 CARLTON 7

spot; steel, black, antique copper coloured
Spot; Stahl, schwarz, kupferfarben-antik
spot; acier, noir, aspect cuivre-antique

L 730, B 160, H 255



E27



3x 40W



9 002759 437176



L 730

43715 CARLTON 7

spot; steel, black, antique copper coloured
Spot; Stahl, schwarz, kupferfarben-antik
spot; acier, noir, aspect cuivre-antique

Ø 160, A 255



E27



1x 40W



9 002759 437152



A 255

43718 CARLTON 7

spot; steel, black, antique copper coloured
Spot; Stahl, schwarz, kupferfarben-antik
spot; acier, noir, aspect cuivre-antique

L 370, B 370, H 255



E27



4x 40W



9 002759 437183



L 370

B 370



43057



43399



43058

43057 CARLTON 4

wall light; steel, black, antique copper coloured
Wandleuchte; Stahl, schwarz, kupferfarben-antik
Applique; acier, noir, aspect cuivre-antique

L 160, H 315, A 225



E27 1x 60W



9 002759 430573



43058 CARLTON 4

table light; steel, black, antique copper coloured
Tischleuchte; Stahl, schwarz, kupferfarben-antik
luminaire de table; acier, noir, aspect cuivre-antique

L 220, B 160, H 505, Base: Ø 170

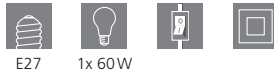

E27 1x 60W



9 002759 430580



43399 CARLTON 6

ceiling light; steel, black, copper
Deckenleuchte; Stahl, schwarz, kupfer
plafonnier; acier, noir, cuivre

H 235, Ø 470



E27 1x 60W



9 002759 433994

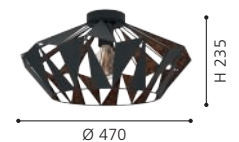



43077

43077 CARLTON 5

table light; steel, black, copper / fabric, black, copper
Tischleuchte; Stahl, schwarz, kupfer / Textil, schwarz, kupfer
luminaire de table; acier, noir, cuivre / tissu, noir, cuivre

H 510, Ø 250



E27



1x 60W



9 002759 430771



49932



43002

49932 CARLTON 1

pendant light; steel, white, honey gold
Hängeleuchte; Stahl, weiss, honiggold
luminaire en suspension; acier, blanc, or

H 1100, Ø 310



E27 1x 60W



9 002759 499327



43002 CARLTON 1

pendant light; steel, white, gold
Hängeleuchte; Stahl, weiss, gold
luminaire en suspension; acier, blanc, or

L 805, B 205, H 1100



E27 3x 60W



9 002759 430023



43001 CARLTON 1

pendant light; steel, white, gold
Hängeleuchte; Stahl, weiss, gold
luminaire en suspension; acier, blanc, or

H 1100, Ø 205



E27 1x 60W



9 002759 430016





43001





49024



49026

49024 CARLTON-P

pendant light; steel, pastel apricot
 Hängeleuchte; Stahl, Pastell apricot
 luminaire en suspension; acier, Pastel abricot

H 1500, Ø 310



E27 1x 60W



9 002759 490249



49026 CARLTON-P

pendant light; steel, pastel light green
 Hängeleuchte; Stahl, Pastell hellgrün
 luminaire en suspension; acier, pastel vert clair

H 1500, Ø 310



E27 1x 60W



9 002759 490263



49931 CARLTON 1

pendant light; steel, black, gold
 Hängeleuchte; Stahl, schwarz, gold
 luminaire en suspension; acier, noir, or

H 1100, Ø 310



E27 1x 60W



9 002759 499310





49931



43909



43908

43909 CARLTON

pendant light; steel, gold-coloured
Hängeleuchte; Stahl, goldfarben
luminaire en suspension; acier, or

L 805, B 205, H 1100



E27



3x 60W



9 002759 439095



43908 CARLTON

ceiling light; steel, gold-coloured
Deckenleuchte; Stahl, goldfarben
plafonnier; acier, or

H 235, Ø 470



E27



1x 60W



9 002759 439088





43815

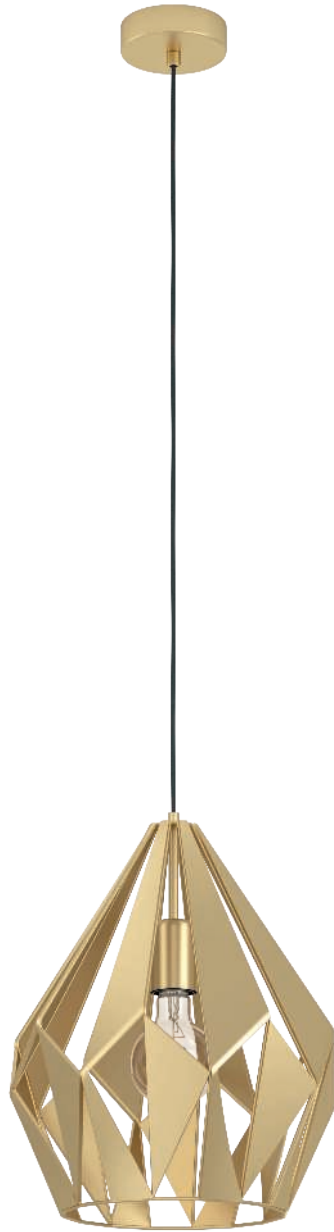

43814

43815 CARLTON

pendant light; steel, gold-coloured
Hängeleuchte; Stahl, goldfarben
luminaire en suspension; acier, or

H 1100, Ø 385



E27



1x 60W



9 002759 438159



43814 CARLTON

pendant light; steel, gold-coloured
Hängeleuchte; Stahl, goldfarben
luminaire en suspension; acier, or

H 1100, Ø 310



E27



1x 60W



9 002759 438142





49258



49259



49933

49258 CARLTON

pendant light; steel, copper-coloured
Hängeleuchte; Stahl, kupferfarben
luminaire en suspension; acier, cuivré

H 1100, Ø 310



E27 1x 60W



9 002759 492588



49259 CARLTON

pendant light; steel, mint
Hängeleuchte; Stahl, mint
luminaire en suspension; acier, menthe

H 1100, Ø 310



E27 1x 60W



9 002759 492595



49933 CARLTON

pendant light; steel, gold-coloured
Hängeleuchte; Stahl, goldfarben
luminaire en suspension; acier, or

H 1100, Ø 310



E27 1x 60W



9 002759 499334





49257 CARLTON

pendant light; steel, black
Hängeleuchte; Stahl, schwarz
luminaire en suspension; acier, noir

H 1100, Ø 310



E27



1x 60W



9 002759 492571



DESIGN
HIGHLIGHT
DETAIL





43692

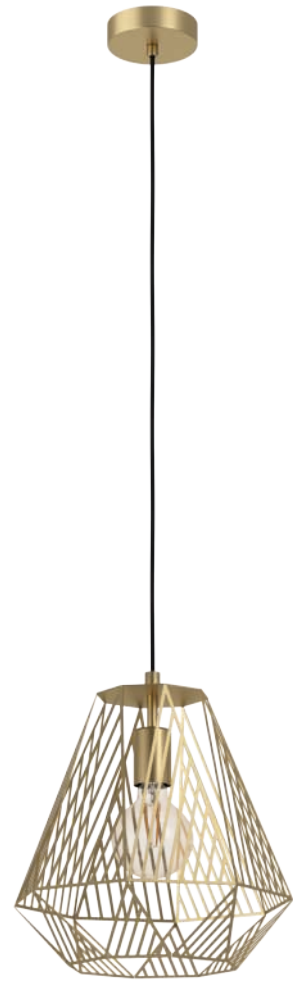

43695

43692 STYPE

pendant light; steel, black
Hängeleuchte; Stahl, schwarz
luminaire en suspension; acier, noir

H 1100, Ø 330



E27



1x 40W



9 002759 436926



43695 STYPE

pendant light; steel, gold-coloured
Hängeleuchte; Stahl, goldfarben
luminaire en suspension; acier, or

H 1100, Ø 330



E27



1x 40W



9 002759 436957





43696



43693

43696 STYPE

pendant light; steel, gold-coloured
Hängeleuchte; Stahl, goldfarben
luminaire en suspension; acier, or

L 960, B 200, H 1100



E27



3x 40W



9 002759 436964



L 960

H 1100

43693 STYPE

pendant light; steel, black
Hängeleuchte; Stahl, schwarz
luminaire en suspension; acier, noir

L 960, B 200, H 1100



E27



3x 40W



9 002759 436933



L 960

H 1100



43359



43361

43359 STRAITON

pendant light; steel, black
Hängeleuchte; Stahl, schwarz
luminaire en suspension; acier, noir

H 1100, Ø 515



E27 1x 60W



9 002759 433598

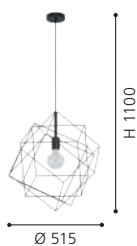

43361 STRAITON

pendant light; steel, black
Hängeleuchte; Stahl, schwarz
luminaire en suspension; acier, noir

L 905, B 240, H 1100



E27 3x 60W



9 002759 433611

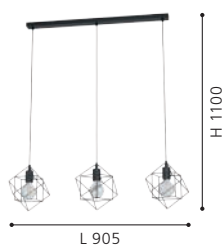

43358 STRAITON

pendant light; steel, black
Hängeleuchte; Stahl, schwarz
luminaire en suspension; acier, noir

L 240, B 205, H 1100



E27 1x 60W



9 002759 433581

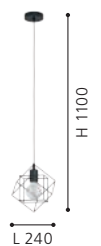



43358



43481



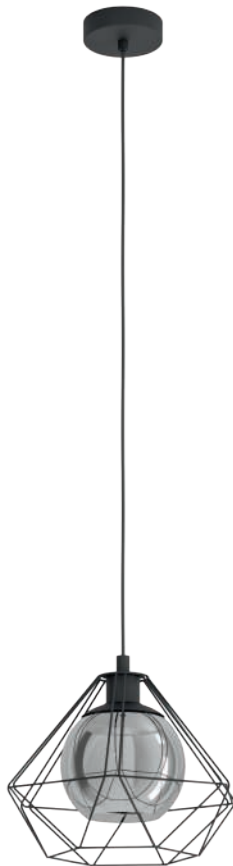

43482



43483

43481 VERNHAM

pendant light; steel, black / glass vaporized, black-transparent
 Hängeleuchte; Stahl, schwarz / Glas bedampft, schwarz-transparent
 luminaire en suspension; acier, noir / verre vaporisé, noir transparent

H 1100, Ø 445



E27



1x 40W



9 002759 434816

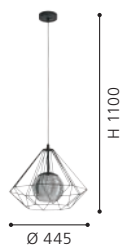

43482 VERNHAM

pendant light; steel, black / glass vaporized, black-transparent
 Hängeleuchte; Stahl, schwarz / Glas bedampft, schwarz-transparent
 luminaire en suspension; acier, noir / verre vaporisé, noir transparent

H 1100, Ø 325



E27



1x 40W



9 002759 434823



43483 VERNHAM

pendant light; steel, black / glass vaporized, black-transparent
 Hängeleuchte; Stahl, schwarz / Glas bedampft, schwarz-transparent
 luminaire en suspension; acier, noir / verre vaporisé, noir transparent

L 1145, B 325, H 1100



E27



3x 40W



9 002759 434830

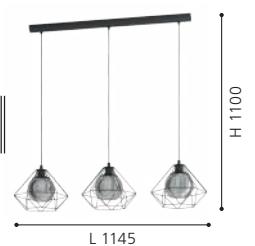



43004



49081

DESIGN
HIGHLIGHT
DETAIL



43004 TARBES

ceiling light; steel, black
Deckenleuchte; Stahl, schwarz
plafonnier; acier, noir

H 275, Ø 325



9 002759 430047

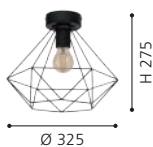

49081 TARBES

wall light; steel, black
Wandleuchte; Stahl, schwarz
Applique; acier, noir

L 155, H 375, A 275



9 002759 490812



49487 CARLTON 2

pendant light; steel, black
Hängeleuchte; Stahl, schwarz
luminaire en suspension; acier, noir

H 1100, Ø 455



9 002759 494872





49487



43766

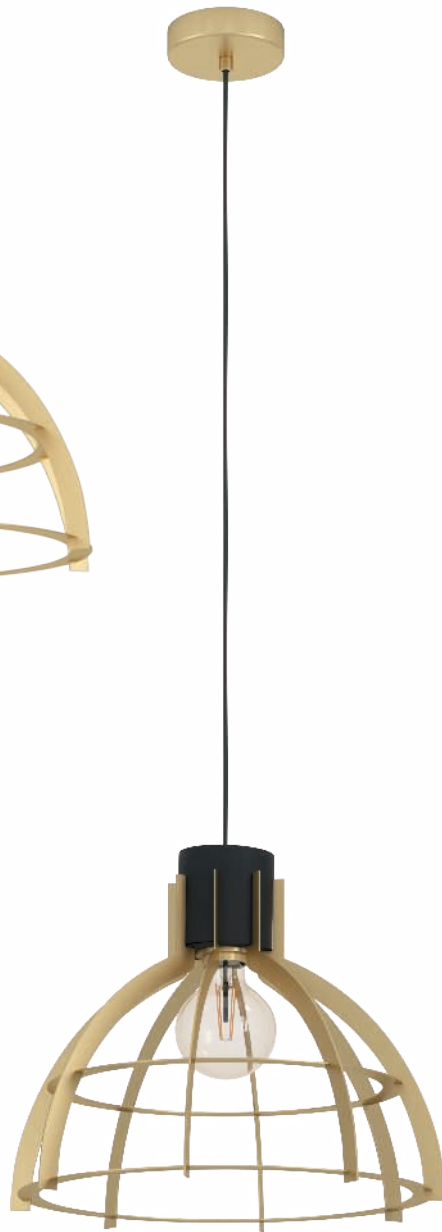

43767

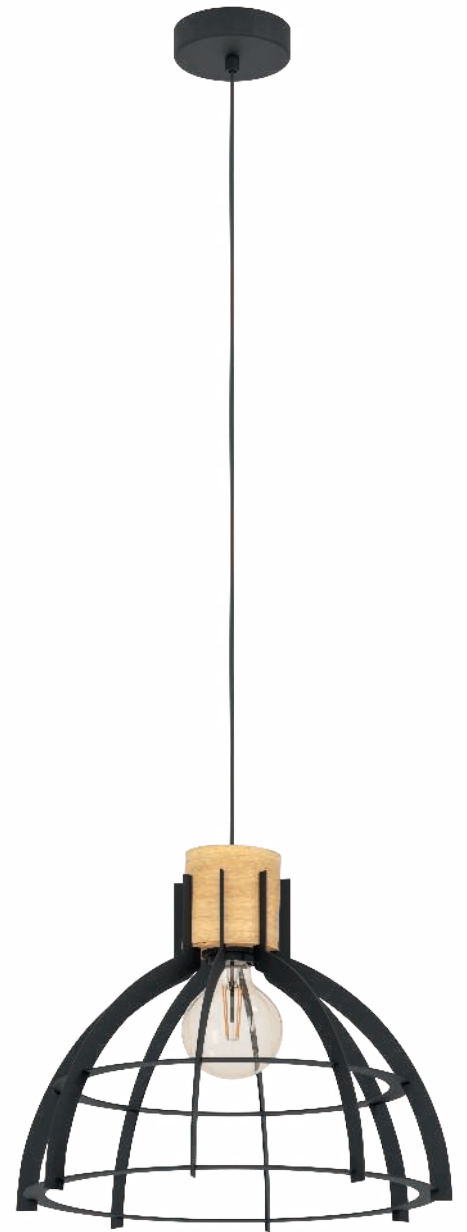

43769

43766 STILLINGTON

ceiling light; steel, black, gold
Deckenleuchte; Stahl, schwarz, gold
plafonnier; acier, noir, or

H 315, Ø 415



E27 1x 40W



9 002759 437664



43767 STILLINGTON

pendant light; steel, black, gold
Hängeleuchte; Stahl, schwarz, gold
luminaire en suspension; acier, noir, or

H 1100, Ø 415



E27 1x 40W



9 002759 437671



43769 STILLINGTON

pendant light; steel, wood, black, brown
Hängeleuchte; Stahl, Holz, schwarz, braun
luminaire en suspension; acier, bois, noir, marron

H 1100, Ø 415



E27 1x 40W



9 002759 437695

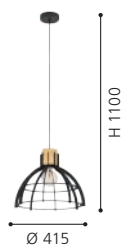



43768

43768 STILLINGTON

ceiling light; steel, wood, black, brown
Deckenleuchte; Stahl, Holz, schwarz, braun
plafonnier; acier, bois, noir, marron

H 315, Ø 415



E27



1x 40W



9 002759 437688

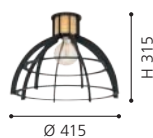



43928
 FSC



43926
 FSC



43927
 FSC

43926 STILLINGTON 1

spot; steel, wood, black, brown
 Spot; Stahl, Holz, schwarz, braun
 spot; acier, bois, noir, marron

H 245, Ø 160

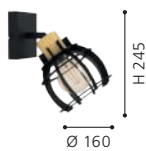

43928 STILLINGTON 1

spot; steel, wood, black, brown
 Spot; Stahl, Holz, schwarz, braun
 spot; acier, bois, noir, marron

L 710, B 160, H 245



43927 STILLINGTON 1

spot; steel, wood, black, brown
 Spot; Stahl, Holz, schwarz, braun
 spot; acier, bois, noir, marron

L 420, B 160, H 245





43925



43925 STILLINGTON 1

pendant light; steel, wood, black, brown
 Hängeleuchte; Stahl, Holz, schwarz, braun
 luminaire en suspension; acier, bois, noir, marron

L 880, B 180, H 1100



E27



3x 40W



9 002759 439255



DESIGN
 HIGHLIGHT
 DETAIL

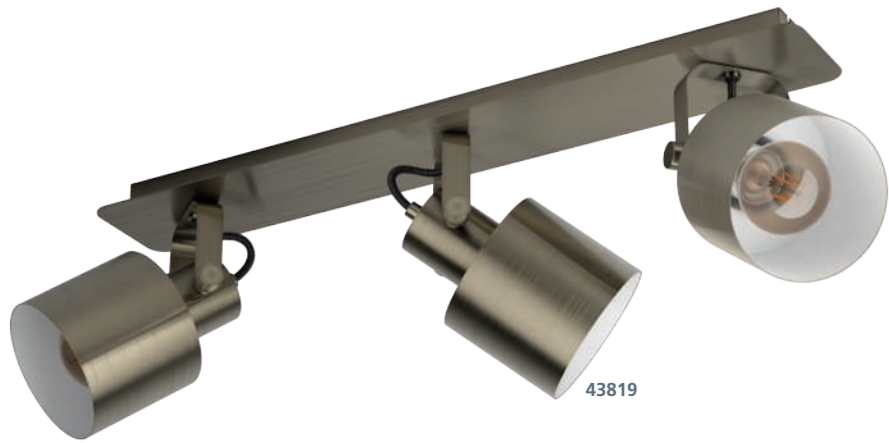

43819



43818



43817

43819 SOUTHERY

spot; steel, brushed creme-gold, white
Spot; Stahl, creme-gold gebürstet, weiss
spot; acier, or crème brossé, blanc

L 700, B 110, H 210



E27 3x 40W



9 002759 438197

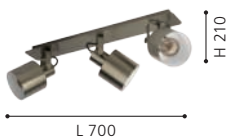

L 700

43818 SOUTHERY

spot; steel, brushed creme-gold, white
Spot; Stahl, creme-gold gebürstet, weiss
spot; acier, or crème brossé, blanc

L 470, B 110, H 210



E27 2x 40W



9 002759 438180



L 470

43817 SOUTHERY

spot; steel, brushed creme-gold, white
Spot; Stahl, creme-gold gebürstet, weiss
spot; acier, or crème brossé, blanc

L 185, B 110, H 210



E27 1x 40W



9 002759 438173

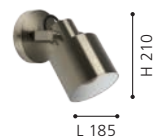

L 185



43816

43816 SOUTHERY

pendant light; steel, brushed creme-gold, white
Hängeleuchte; Stahl, creme-gold gebürstet, weiss
luminaire en suspension; acier, or crème brossé, blanc

H 1100, Ø 350



E27



1x 40W



9 002759 438166





44028



DETAIL LINTMILL

The brushed brass shade is adjustable.
 Die gebürstete Messingscheibe ist verstellbar.
 Le disque en laiton brossé est réglable.



44027

44028 LINTMILL

wall/ceiling light; steel, black / glass, grey
 Wand- / Deckenleuchte; Stahl, schwarz / Glas, grau
 Applique/Plafonnier; acier, noir / verre, gris

H 75, Ø 300



44027 LINTMILL

ceiling light; steel, black, brushed brass / glass, grey
 Deckenleuchte; Stahl, schwarz, messing-gebürstet / Glas, grau
 plafonnier; acier, noir, laiton brossé / verre, gris

H 200, Ø 530

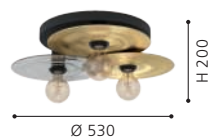

44029 LINTMILL

pendant light; steel, black / steel, brushed brass
 Hängeleuchte; Stahl, schwarz / Stahl, messing-gebürstet
 luminaire en suspension; acier, noir / acier, laiton brossé

H 1100, Ø 400

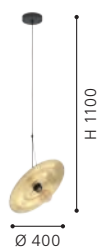



44029



43443

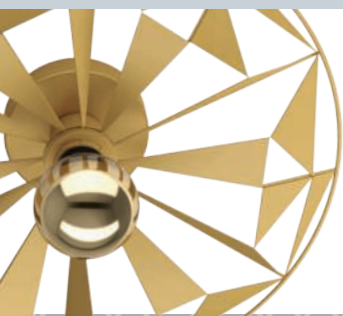

DETAIL 43599

These ceiling luminaires have a great play of light.

Diese Deckenleuchten verfügen über ein tolles Lichtspiel.

Ces plafonniers disposent d'un superbe jeu de lumière.

43443 CASTANUELO

wall/ceiling light; steel, gold
Wand- / Deckenleuchte; Stahl, gold
Applique/Plafonnier; acier, or

H 105, Ø 425



E27



1x 40W



9 002759 434434



Ø 425

H 105



43599



43808



43809

43599 CASTANUELO

wall/ceiling light; steel, gold
Wand- / Deckenleuchte; Stahl, gold
Applique/Plafonnier; acier, or

H 100, Ø 425



E27



1x 40W



9 002759 435998



H 100

Ø 425

43808 CASTANUELO

table light; steel, black, gold
Tischleuchte; Stahl, schwarz, gold
luminaire de table; acier, noir, or

L 370, B 270, H 575, Base: Ø 295



E27



1x 40W



9 002759 438081

L 370



H 575

Ø 295

43809 CASTANUELO

floor light; steel, black, gold
Stehleuchte; Stahl, schwarz, gold
lampadaire; acier, noir, or

L 500, B 270, H 1520, Base: Ø 745



E27



1x 40W



9 002759 438098

L 500



H 1520

Ø 745



43679

43679 TARBES

pendant light; steel, brushed brass
Hängeleuchte; Stahl, messing-gebürstet
luminaire en suspension; acier, laiton brossé

H 1100, Ø 325



E27



1x 60W



9 002759 436797





43678



43681



43682

43678 TARDES

ceiling light; steel, brushed brass
Deckenleuchte; Stahl, messing-gebürstet
plafonnier; acier, laiton brossé

H 275, Ø 325



E27



1x 60W



9 002759 436780



Ø 325

H 275

43681 TARDES

pendant light; steel, brushed brass
Hängeleuchte; Stahl, messing-gebürstet
luminaire en suspension; acier, laiton brossé

H 1300, Ø 175



E27



1x 60W



9 002759 436810



Ø 175

H 1300

43682 TARDES

pendant light; steel, brushed brass
Hängeleuchte; Stahl, messing-gebürstet
luminaire en suspension; acier, laiton brossé

L 795, B 175, H 1300



E27



3x 60W



9 002759 436827



L 795

H 1300



94191

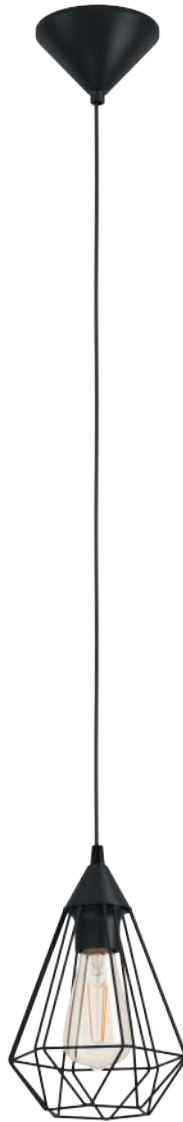

94187

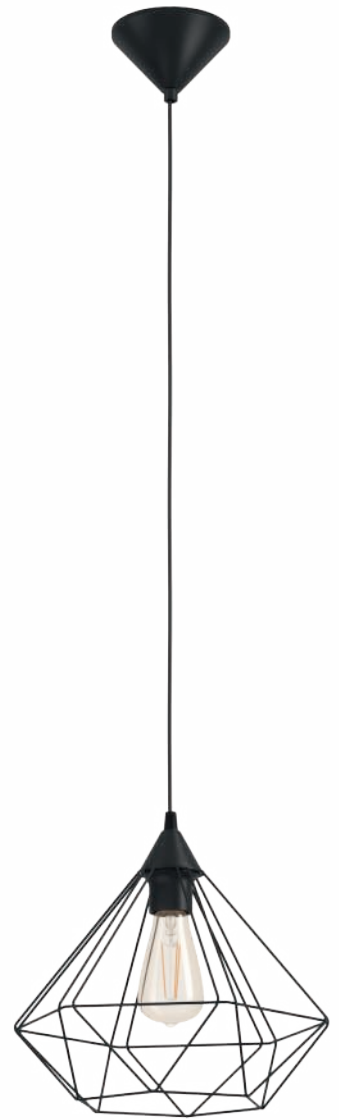

94188

94191 TARDES

pendant light; steel, black / steel, black
 Hängeleuchte; Stahl, schwarz / Stahl, schwarz
 luminaire en suspension; acier, noir / acier, noir

H 1100, Ø 310



E27 3x 60W



9 002759 941918



94187 TARDES

pendant light; plastic, black / steel, black
 Hängeleuchte; Kunststoff, schwarz / Stahl, schwarz
 luminaire en suspension; plastique, noir / acier, noir

H 1100, Ø 175



E27 1x 60W



9 002759 941871

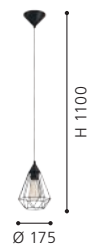

94188 TARDES

pendant light; plastic, black / steel, black
 Hängeleuchte; Kunststoff, schwarz / Stahl, schwarz
 luminaire en suspension; plastique, noir / acier, noir

H 1100, Ø 325



E27 1x 60W



9 002759 941888





94189



94192

94189 TARBES

pendant light; steel, black / steel, black
 Hängeleuchte; Stahl, schwarz / Stahl, schwarz
 luminaire en suspension; acier, noir / acier, noir

L 790, B 175, H 1100



E27



3x 60W



9 002759 941895



L 790

H 1100

94192 TARBES

table light; steel, black / steel, black
 Tischleuchte; Stahl, schwarz / Stahl, schwarz
 luminaire de table; acier, noir / acier, noir

H 265, Ø 175



E27



1x 60W



9 002759 941925



H 265

Ø 175



94194

94195

94194 TARDES

pendant light; plastic, black / steel, copper-coloured
 Hängeleuchte; Kunststoff, schwarz / Stahl, kupferfarben
 luminaire en suspension; plastique, noir / acier, cuivré

H 1100, Ø 325



E27 1x 60W



9 002759 941949



94195 TARDES

pendant light; steel, black / steel, copper-coloured
 Hängeleuchte; Stahl, schwarz / Stahl, kupferfarben
 luminaire en suspension; acier, noir / acier, cuivré

L 790, B 175, H 1100



E27 3x 60W



9 002759 941956

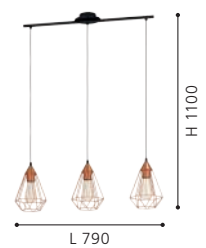



94196



94193

94196 TARBES

pendant light; steel, black / steel, copper-coloured
Hängeleuchte; Stahl, schwarz / Stahl, kupferfarben
luminaire en suspension; acier, noir / acier, cuivré

H 1100, Ø 310



E27



3x 60W



9 002759 941963



H 1100

Ø 310

94193 TARBES

pendant light; plastic, black / steel, copper-coloured
Hängeleuchte; Kunststoff, schwarz / Stahl, kupferfarben
luminaire en suspension; plastique, noir / acier, cuivré

H 1100, Ø 175



E27



1x 60W



9 002759 941932



H 1100

Ø 175



49644

49645

49646

49644 ROCCAMENA

pendant light; steel, black, copper
 Hängeleuchte; Stahl, schwarz, kupfer
 luminaire en suspension; acier, noir, cuivre

H 1100, Ø 130



E27 1x 60W



9 002759 496449

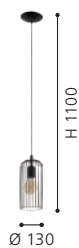

49645 ROCCAMENA

pendant light; steel, black, copper
 Hängeleuchte; Stahl, schwarz, kupfer
 luminaire en suspension; acier, noir, cuivre

L 730, B 130, H 1100



E27 3x 60W



9 002759 496456



49646 ROCCAMENA

table light; steel, black, copper
 Tischleuchte; Stahl, schwarz, kupfer
 luminaire de table; acier, noir, cuivre

H 310, Ø 130, Base: Ø 130



E27 1x 60W



9 002759 496463





49142

49142 CLEVEDON

pendant light; steel, black
Hängeleuchte; Stahl, schwarz
luminaire en suspension; acier, noir

L 780, B 170, H 1100



E27



3x 60W



9 002759 491420

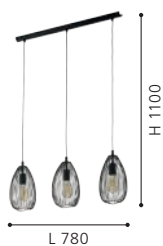



49472



49477

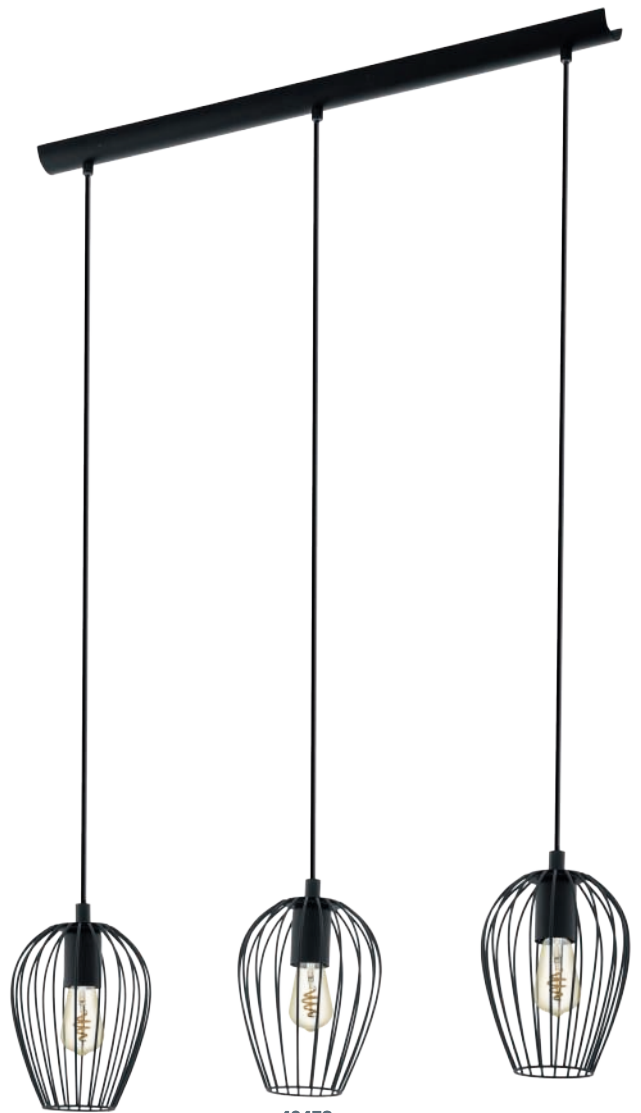

49478

49472 NEWTOWN

pendant light; steel, black
Hängeleuchte; Stahl, schwarz
luminaire en suspension; acier, noir

H 1100, Ø 275



E27 1x 60W



9 002759 494728



49477 NEWTOWN

pendant light; steel, black
Hängeleuchte; Stahl, schwarz
luminaire en suspension; acier, noir

H 1100, Ø 160



E27 1x 60W



9 002759 494773



49478 NEWTOWN

pendant light; steel, black
Hängeleuchte; Stahl, schwarz
luminaire en suspension; acier, noir

L 700, B 160, H 1100



E27 3x 60W



9 002759 494780





49479



49481



49474

49479 NEWTOWN

pendant light; steel, black
Hängeleuchte; Stahl, schwarz
luminaire en suspension; acier, noir

H 1300, Ø 380



E27



3x 60W



9 002759 494797



H 1300

Ø 380

49481 NEWTOWN

table light; steel, black
Tischleuchte; Stahl, schwarz
luminaire de table; acier, noir

H 230, Ø 160, Base: Ø 120



E27



1x 60W



9 002759 494810



Ø 160

H 230

Ø 120

49474 NEWTOWN

floor light; steel, black
Stehleuchte; Stahl, schwarz
lampadaire; acier, noir

H 1595, Ø 275, Base: Ø 230



E27



1x 60W



9 002759 494742



Ø 275

H 1595

Ø 230

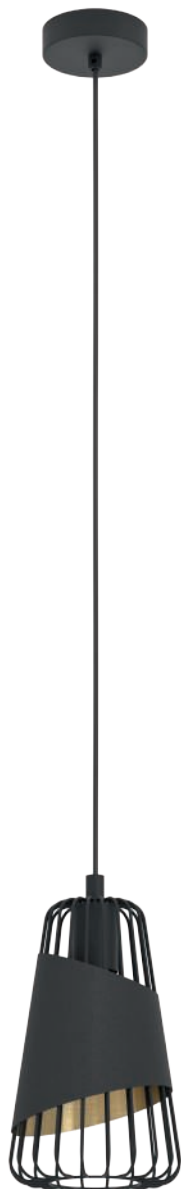

49447



49448

49447 AUSTELL

pendant light; steel, black / steel, fabric, black, gold
 Hängeleuchte; Stahl, schwarz / Stahl, Textil, schwarz, gold
 luminaire en suspension; acier, noir / acier, tissu, noir, or

H 1100, Ø 165



E27 1x 60W



9 002759 494476

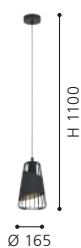

49448 AUSTELL

pendant light; steel, black / steel, fabric, black, gold
 Hängeleuchte; Stahl, schwarz / Stahl, Textil, schwarz, gold
 luminaire en suspension; acier, noir / acier, tissu, noir, or

L 765, B 165, H 1100



E27 3x 60W



9 002759 494483



49446 AUSTELL

pendant light; steel, black / steel, fabric, black, gold
 Hängeleuchte; Stahl, schwarz / Stahl, Textil, schwarz, gold
 luminaire en suspension; acier, noir / acier, tissu, noir, or

H 1100, Ø 360



E27 1x 60W



9 002759 494469





49446



43848





43847



43849



43848 PLIMSOLL

pendant light; steel, wood, black
Hängeleuchte; Stahl, Holz, schwarz
luminaire en suspension; acier, bois, noir

L 770, B 95, H 1100



E27



4x 15W



9 002759 438487

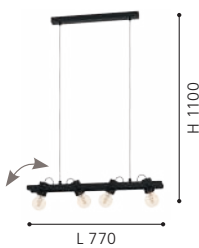

43847 PLIMSOLL

ceiling light; steel, wood, black
Deckenleuchte; Stahl, Holz, schwarz
plafonnier; acier, bois, noir

L 770, B 95, H 165



E27



4x 15W



9 002759 438470



43849 PLIMSOLL

table light; steel, wood, black
Tischleuchte; Stahl, Holz, schwarz
luminaire de table; acier, bois, noir

L 105, B 75, H 255, Base: Ø 135



E27



1x 15W



9 002759 438494

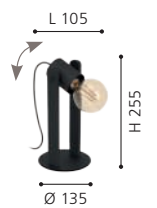



44006



44005

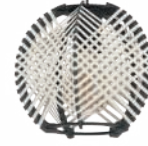

44007

44006 WAVERTON

pendant light; steel, black / fabric, wood, white, black
 Hängeleuchte; Stahl, schwarz / Textil, Holz, weiss, schwarz
 luminaire en suspension; acier, noir / tissu, bois, blanc, noir

H 1100, Ø 480



E27 1x 40W



9 002759 440060



44005 WAVERTON

pendant light; steel, black / fabric, wood, white, black
 Hängeleuchte; Stahl, schwarz / Textil, Holz, weiss, schwarz
 luminaire en suspension; acier, noir / tissu, bois, blanc, noir

H 1100, Ø 400



E27 1x 40W



9 002759 440053



44007 WAVERTON

pendant light; steel, black / fabric, wood, white, black
 Hängeleuchte; Stahl, schwarz / Textil, Holz, weiss, schwarz
 luminaire en suspension; acier, noir / tissu, bois, blanc, noir

L 920, B 220, H 1100



E27 3x 40W



9 002759 440077

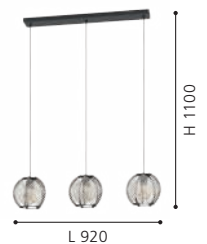



44008



44009

44008 WAVERTON

table light; steel, black / fabric, wood, white, black
 Tischleuchte; Stahl, schwarz / Textil, Holz, weiss, schwarz
 luminaire de table; acier, noir / tissu, bois, blanc, noir

H 400, Ø 220, Base: Ø 225



E27 1x 40W



9 002759 440084



44009 WAVERTON

floor light; steel, black / fabric, wood, white, black
 Stehleuchte; Stahl, schwarz / Textil, Holz, weiss, schwarz
 lampadaire; acier, noir / tissu, bois, blanc, noir

H 1430, Ø 400, Base: Ø 665



E27 1x 40W



9 002759 440091





43426



43427



DETAIL HORNWOOD 1

The heads can be adjusted or fixed in position with the lateral screws.
Die Köpfe können mittels den seitlichen Schrauben verstellt oder fixiert werden.
Les têtes peuvent être réglées ou fixées à l'aide des vis latérales.

43426 HORNWOOD 1

pendant light; steel, wood, black / fabric, white
Hängeleuchte; Stahl, Holz, schwarz / Textil, weiss
luminaire en suspension; acier, bois, noir / tissu, blanc

L 780, B 195, H 1100



E27



3x 28W



9 002759 434267

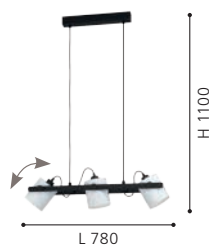

43427 HORNWOOD 1

wall light; steel, wood, black / fabric, white
Wandleuchte; Stahl, Holz, schwarz / Textil, weiss
Applique; acier, bois, noir / tissu, blanc

L 195, A 255



E27



1x 28W



9 002759 434274





44098



44114



44115



44098 BIDFORD

floor light; wood, steel, brown / fabric, cappuccino, gold
 Stehleuchte; Holz, Stahl, braun / Textil, cappuccino, gold
 lampadaire; bois, acier, marron / tissu, cappuccino, or

H 1540, Ø 460, Base: Ø 700



E27



1x 60W



9 002759 440985

44114 LANTADA

floor light; wood, steel, natural / fabric, beige
 Stehleuchte; Holz, Stahl, natur / Textil, beige
 lampadaire; bois, acier, naturel / tissu, beige

H 1430, Ø 450, Base: Ø 975



E27



1x 60W



9 002759 441142

44115 LANTADA

floor light; wood, steel, nut / fabric, taupe
 Stehleuchte; Holz, Stahl, nuss / Textil, taupe
 lampadaire; bois, acier, noisette / tissu, taupe

H 1430, Ø 450, Base: Ø 975



E27



1x 60W



9 002759 441159



49386



49519



DESIGN
HIGHLIGHT
DETAIL

49386 CHESTER

floor light; steel, black, copper
Stehleuchte; Stahl, schwarz, kupfer
lampadaire; acier, noir, cuivre

H 1495, Base: Ø 600



E27



1x 60W

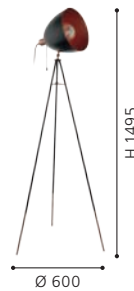

9 002759 493868

49519 CHESTER 1

floor light; steel, rust-coloured, gold
Stehleuchte; Stahl, rostfarben, gold
lampadaire; acier, rouille, or

H 1495, Base: Ø 600



E27



1x 60W



9 002759 495190

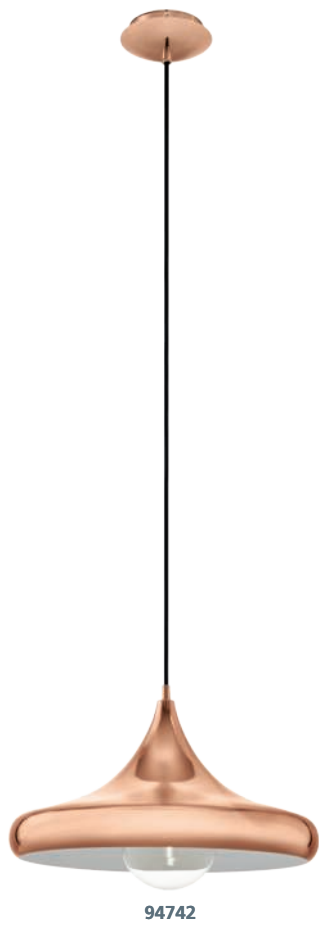

94742 CORETTO 2

pendant light; steel, copper
Hängeleuchte; Stahl, kupfer
luminaire en suspension; acier, cuivre

H 1100, Ø 400



E27



1x 60W



9 002759 947422

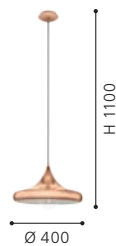

49449 HAPTON

pendant light; steel, copper
Hängeleuchte; Stahl, kupfer
luminaire en suspension; acier, cuivre

H 1100, Ø 290



E27



1x 60W



9 002759 494490

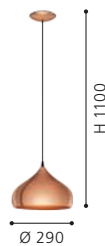



43633



43634

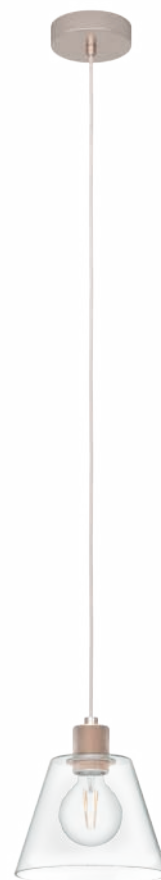

43631

43633 COPLEY

pendant light; steel, aluminium, gold-coloured / glass, clear
Hängeleuchte; Stahl, Alu, goldfarben / Glas, klar
luminaire en suspension; acier, aluminium, or / verre,
transparent

H 1100, Ø 200



E27 1x 40W



9 002759 436339



43634 COPLEY

pendant light; steel, aluminium, gold-coloured / glass, clear
Hängeleuchte; Stahl, Alu, goldfarben / Glas, klar
luminaire en suspension; acier, aluminium, or / verre,
transparent

L 900, B 200, H 1100



E27 3x 40W



9 002759 436346



43631 COPLEY

pendant light; steel, aluminium, rose gold / glass, clear
Hängeleuchte; Stahl, Alu, roségold / Glas, klar
luminaire en suspension; acier, aluminium, rose or / verre,
transparent

H 1100, Ø 200



E27 1x 40W



9 002759 436315





43632

43632 COPLEY

pendant light; steel, aluminium, rose gold / glass, clear
Hängeleuchte; Stahl, Alu, roségold / Glas, klar
luminaire en suspension; acier, aluminium, rose or / verre,
transparent

L 900, B 200, H 1100



E27



3x 40W



9 002759 436322

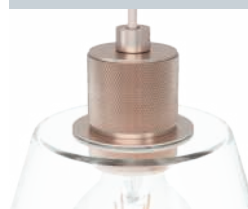

DETAIL COPLEY

These luminaires have a special socket.

Diese Leuchten verfügen über eine spezielle Fassung.

Ces luminaires disposent d'une douille spéciale.



43331



43333

43331 WRINGTON

pendant light; steel, black
Hängeleuchte; Stahl, schwarz
luminaire en suspension; acier, noir

H 1100, Ø 300



E27



1x 60W



9 002759 433314



43333 WRINGTON

pendant light; steel, black
Hängeleuchte; Stahl, schwarz
luminaire en suspension; acier, noir

L 740, B 150, H 1100



E27



3x 60W



9 002759 433338

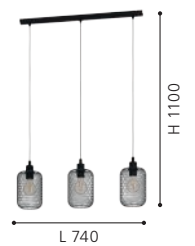



43096



32468

43096 WRINGTON

table light; steel, black
Tischleuchte; Stahl, schwarz
luminaire de table; acier, noir

H 285, Ø 150, Base: Ø 100



E27



1x 60W



9 002759 430962



32468 WRINGTON

floor light; steel, black
Stehleuchte; Stahl, schwarz
lampadaire; acier, noir

L 635, B 300, H 1940, Base: Ø 300



E27



1x 60W



9 002759 324681

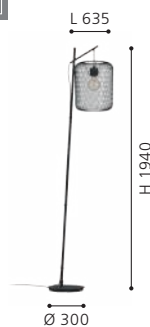



43305

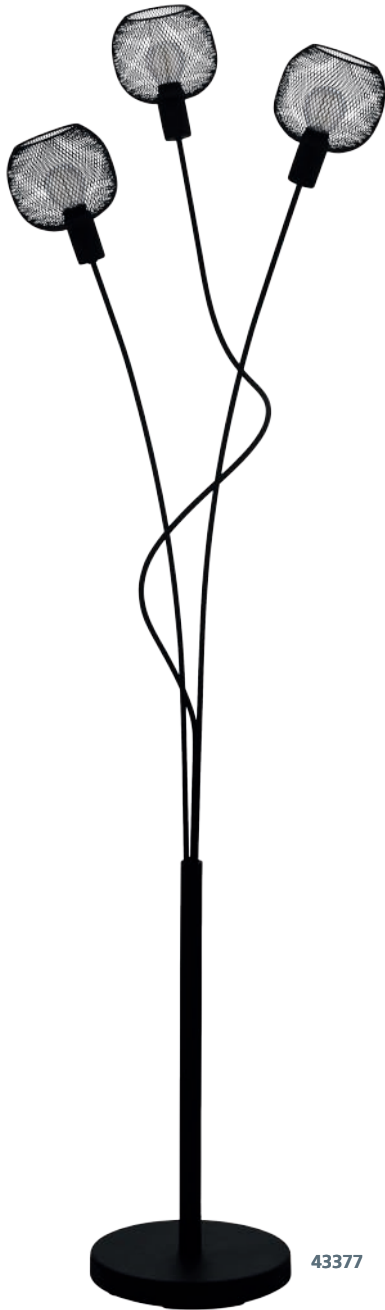

43377

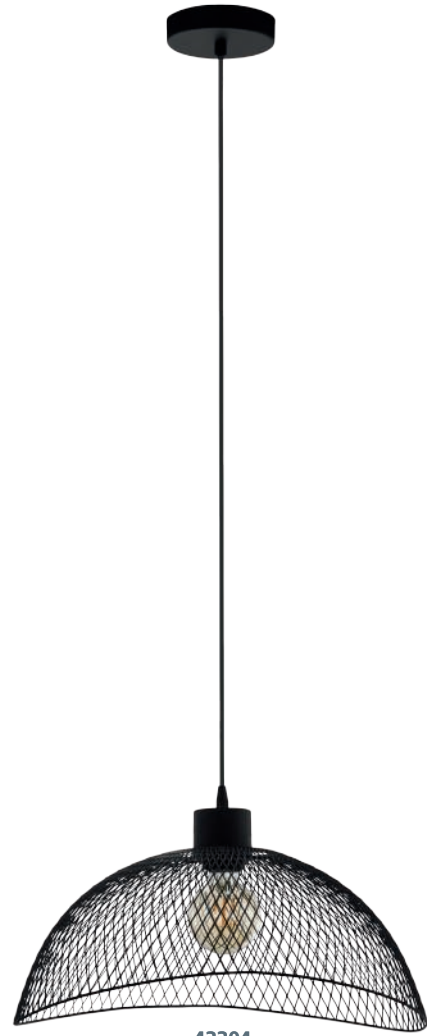

43304

43305 POMPEYA

pendant light; steel, black
Hängeleuchte; Stahl, schwarz
luminaire en suspension; acier, noir

L 570, B 540, H 1100



E27



1x 60W



9 002759 433055



43377 WRINGTON 1

floor light; steel, black
Stehleuchte; Stahl, schwarz
lampadaire; acier, noir

L 340, B 305, H 1495, Base: Ø 230



E14



3x 40W



9 002759 433772

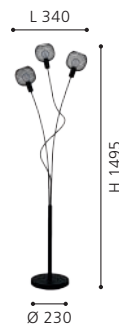

43304 POMPEYA

pendant light; steel, black
Hängeleuchte; Stahl, schwarz
luminaire en suspension; acier, noir

L 450, B 440, H 1100



E27



1x 60W



9 002759 433048





43669

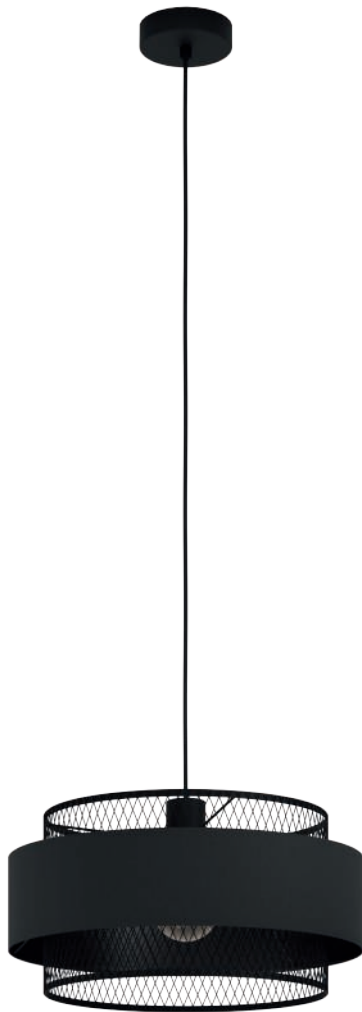

43668

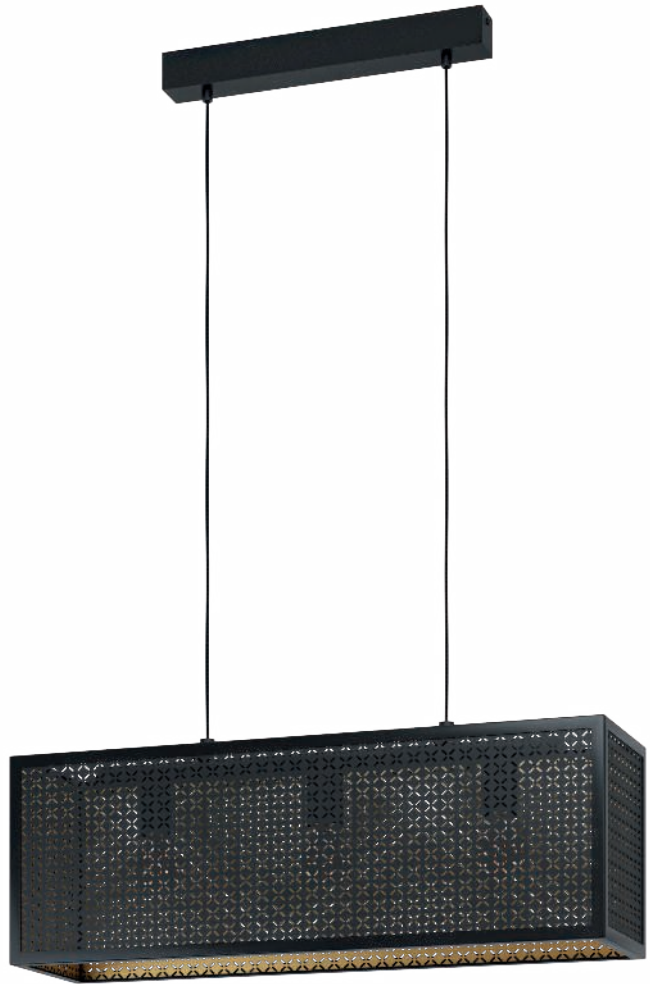

43559

43669 BAZELY

pendant light; steel, black / fabric, black
 Hängeleuchte; Stahl, schwarz / Textil, schwarz
 luminaire en suspension; acier, noir / tissu, noir

L 990, B 230, H 1100



E27



3x 40W



9 002759 436681



43668 BAZELY

pendant light; steel, black / fabric, black
 Hängeleuchte; Stahl, schwarz / Textil, schwarz
 luminaire en suspension; acier, noir / tissu, noir

H 1100, Ø 400



E27



1x 40W



9 002759 436681



43559 SALLICANO

pendant light; steel, black, gold
 Hängeleuchte; Stahl, schwarz, gold
 luminaire en suspension; acier, noir, or

L 730, B 200, H 1100



E27



3x 40W



9 002759 435592

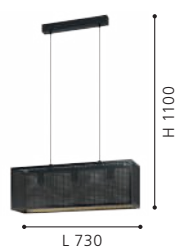

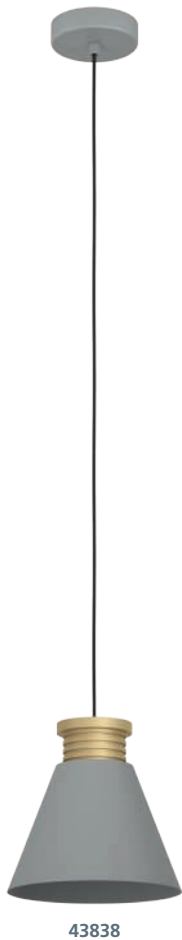

43838



43839



43841

43838 TWICKEN

pendant light; steel, grey, gold
Hängeleuchte; Stahl, grau, gold
luminaire en suspension; acier, gris, or

H 1100, Ø 220



E27 1x 40W



9 002759 438388



43839 TWICKEN

pendant light; steel, grey, gold
Hängeleuchte; Stahl, grau, gold
luminaire en suspension; acier, gris, or

L 920, B 220, H 1100



E27 3x 40W



9 002759 438395

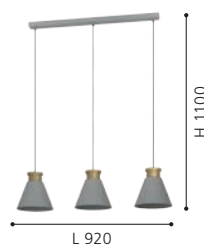

43841 TWICKEN

table light; steel, grey, gold
Tischleuchte; Stahl, grau, gold
luminaire de table; acier, gris, or

L 155, B 150, H 195, Base: B 150



E27 1x 28W



9 002759 438418





43835



43836



43837

43835 TWICKEN

spot; steel, grey, gold
Spot; Stahl, grau, gold
spot; acier, gris, or

L 180, B 150, H 200



E27



1x 28W



9 002759 438357

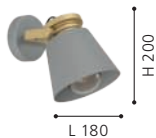

L 180

H 200

43836 TWICKEN

spot; steel, grey, gold
Spot; Stahl, grau, gold
spot; acier, gris, or

L 370, B 205, H 175



E27



2x 40W



9 002759 438364



L 370

H 175

43837 TWICKEN

spot; steel, grey, gold
Spot; Stahl, grau, gold
spot; acier, gris, or

L 590, B 205, H 175



E27



3x 40W



9 002759 438371



L 590

H 175



43825



DESIGN
HIGHLIGHT
DETAIL

43825 MATLOCK

pendant light; steel, grey, black
Hängeleuchte; Stahl, grau, schwarz
luminaire en suspension; acier, gris, noir

H 1100, Ø 380



E27



1x 40W



9 002759 438258

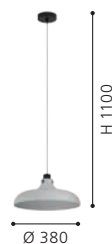



43826



43842

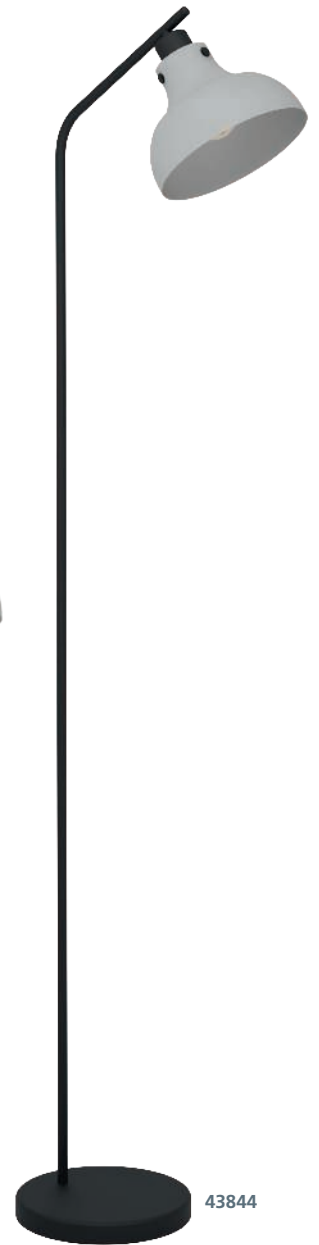

43844

43826 MATLOCK

pendant light; steel, grey, black
 Hängeleuchte; Stahl, grau, schwarz
 luminaire en suspension; acier, gris, noir

L 900, B 200, H 1100



E27 3x 40W



9 002759 438265



L 900

H 1100

43842 MATLOCK

ceiling light; steel, grey, black
 Deckenleuchte; Stahl, grau, schwarz
 plafonnier; acier, gris, noir

H 210, Ø 380



E27 1x 40W



9 002759 438425



Ø 380

H 210

43844 MATLOCK

floor light; steel, grey, black
 Stehleuchte; Stahl, grau, schwarz
 lampadaire; acier, gris, noir

L 405, B 200, H 1580, Base: B 230



E27 1x 40W



9 002759 438449

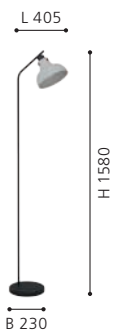

L 405

H 1580

B 230



43829



43827



43828

43829 MATLOCK

spot; steel, wood, grey, black
Spot; Stahl, Holz, grau, schwarz
spot; acier, bois, gris, noir

L 740, B 145, H 225



E27



3x 40W



9 002759 438296



L 740

43828 MATLOCK

spot; steel, wood, grey, black
Spot; Stahl, Holz, grau, schwarz
spot; acier, bois, gris, noir

L 520, B 145, H 225



E27



2x 40W



9 002759 438289



L 520

43827 MATLOCK

spot; steel, grey, black
Spot; Stahl, grau, schwarz
spot; acier, gris, noir

L 245, B 145, H 225



E27



1x 40W



9 002759 438272



L 245



43843

43843 MATLOCK

wall light; steel, grey, black
Wandleuchte; Stahl, grau, schwarz
Applique; acier, gris, noir

L 200, H 250, A 800



E27



1x 40W



9 002759 438432



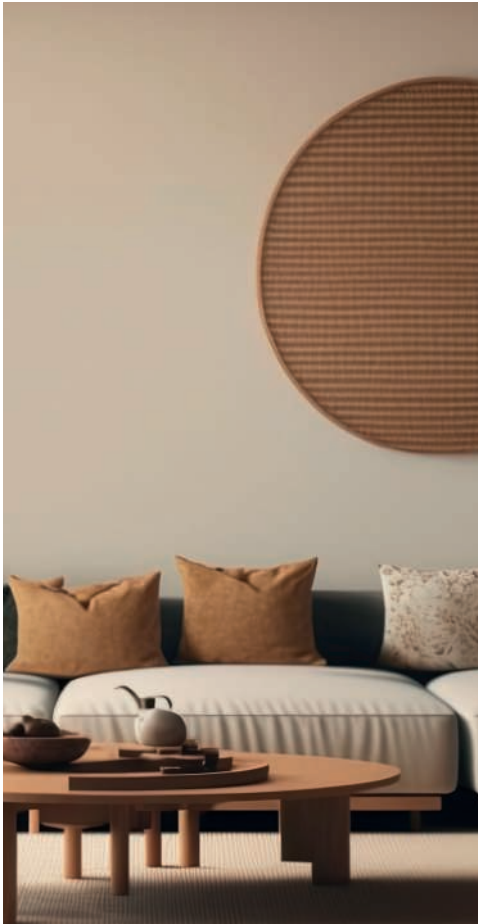

JAPANDI

#PEACE
#ROOTS

Japanese interior style is characterized primarily by minimalism, with natural materials and colors. The roots of this trend reach far into the past and are based on long tradition. Craftsmanship has always been appreciated. The popularity of the style led to its combination with other trends, such as Scandinavian design, in recent years. In summary, peaceful simplicity, balance and the natural beauty count.

Der japanische Einrichtungsstil ist vor allem durch Minimalismus, natürliche Materialien und Farben gekennzeichnet. Die Wurzeln dieses Trends reichen weit in die Vergangenheit zurück und beruhen auf einer langen Tradition. Handwerkliches Können wurde schon immer geschätzt. Die Beliebtheit des Stils führte in den letzten Jahren zu seiner Kombination mit anderen Trends, wie dem skandinavischen Design. Zusammenfassend lässt sich sagen, dass friedliche Einfachheit, Ausgewogenheit und die natürliche Schönheit zählen.

Le style d'intérieur japonais se caractérise principalement par le minimalisme, avec des matériaux et des couleurs naturels. Les racines de cette tendance remontent loin dans le passé et reposent sur une longue tradition. Le savoir-faire artisanal a toujours été apprécié. La popularité de ce style a conduit à sa combinaison avec d'autres tendances, comme le design scandinave, ces dernières années. En résumé, la simplicité paisible, l'équilibre et la beauté naturelle comptent.



MIDSUMER
182-183



OXPARK
184-185



BUTTERBURN
186-187



BELGRAVE
188



MINTING
191



SUMMERHILL
192-194



ASBY
195



DOLWEN
196-197



BARLSTON
198-199



ALSAGER
200-201



This product is available in different colors and shapes./ Dieser Artikel ist in unterschiedlichen Farben und Formen verfügbar.
Cet article est disponible en différentes couleurs et formes.



43998



44002



44001

43998 MIDSUMER

ceiling light; steel, black / fabric, cream
Deckenleuchte; Stahl, schwarz / Textil, creme
plafonnier; acier, noir / tissu, crème

H 175, Ø 380



E27



1x 40W



9 002759 439989



44002 MIDSUMER

table light; steel, black / fabric, cream
Tischleuchte; Stahl, schwarz / Textil, creme
luminaire de table; acier, noir / tissu, crème

H 440, Ø 380, Base: Ø 200



E27



1x 40W



9 002759 440022



44001 MIDSUMER

pendant light; steel, black / fabric, cream
Hängeleuchte; Stahl, schwarz / Textil, creme
luminaire en suspension; acier, noir / tissu, crème

L 920, B 220, H 1100



E27



3x 40W



9 002759 440015

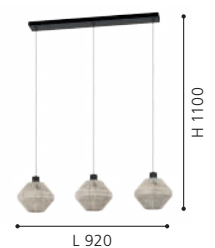



43999

43999 MIDSUMER

pendant light; steel, black / fabric, cream
Hängeleuchte; Stahl, schwarz / Textil, creme
luminaire en suspension; acier, noir / tissu, crème

H 1100, Ø 380



E27



1x 40W



9 002759 439996

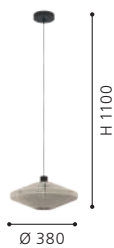

DESIGN
HIGHLIGHT
DETAIL





PURE

COLLECTION



43943

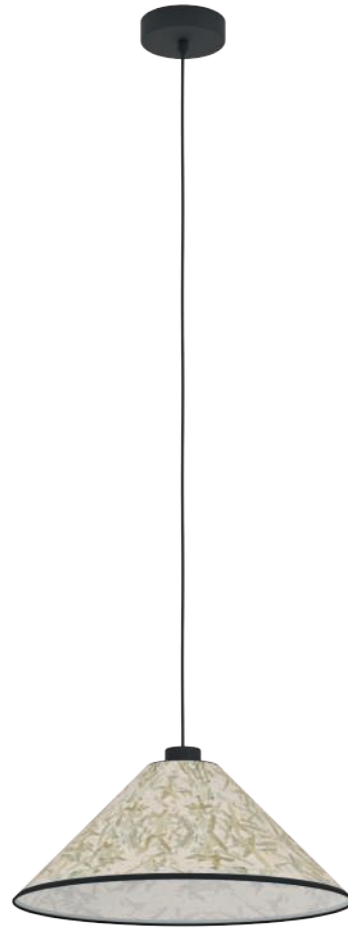

43942



43941

43943 OXPARK

pendant light; steel, black / fabric with bamboo leaves, white, green

Hängeleuchte; Stahl, schwarz / Textil mit Bambusblättern, weiss, grün

luminaire en suspension; acier, noir / tissu avec des feuilles de bam, blanc, vert

L 920, B 220, H 1100



E27



3x 25W



9 002759 439439



43942 OXPARK

pendant light; steel, black / fabric with bamboo leaves, white, green

Hängeleuchte; Stahl, schwarz / Textil mit Bambusblättern, weiss, grün

luminaire en suspension; acier, noir / tissu avec des feuilles de bam, blanc, vert

H 1100, Ø 420



E27



1x 25W



9 002759 439422



43941 OXPARK

ceiling light; steel, black / fabric with bamboo leaves, white, green

Deckenleuchte; Stahl, schwarz / Textil mit Bambusblättern, weiss, grün

plafonnier; acier, noir / tissu avec des feuilles de bam, blanc, vert

H 195, Ø 420



E27



1x 25W



9 002759 439415

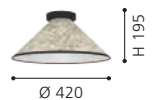



43944

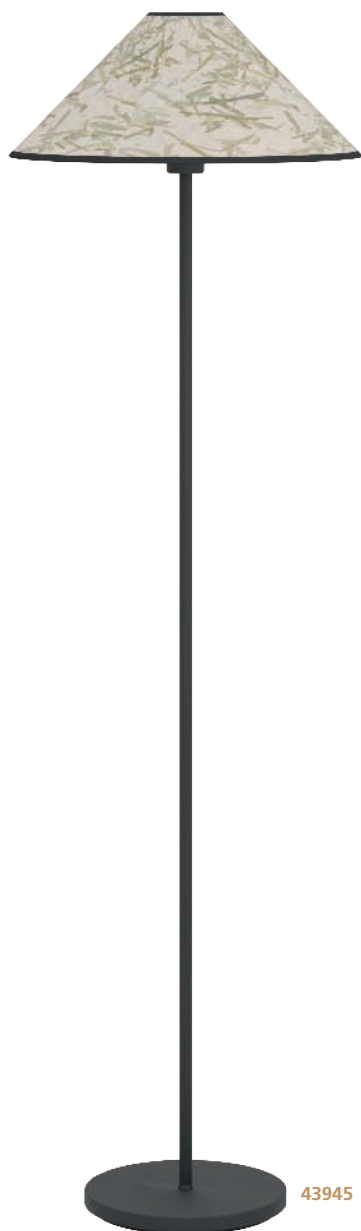

43945

DESIGN
HIGHLIGHT
DETAIL



DETAIL OXPARK

Dried bamboo leaves on flax fleece - a piece of nature for your own four walls.

Getrocknete Bambusblätter auf Flax Fleece - ein Stück Natur für Ihre eigenen vier Wände.

Des feuilles de bambou séchées sur un voile de lin - un morceau de nature pour vos propres murs.

43944 OXPARK

table light; steel, black / fabric with bamboo leaves, white, green

Tischleuchte; Stahl, schwarz / Textil mit Bambusblättern, weiss, grün

luminaire de table; acier, noir / tissu avec des feuilles de bam, blanc, vert

H 415, Ø 220, Base: Ø 145



E27



1x 25W



9 002759 439446

Ø 220



H 415



Ø 145

43945 OXPARK

floor light; steel, black / fabric with bamboo leaves, white, green

Stehleuchte; Stahl, schwarz / Textil mit Bambusblättern, weiss, grün

lampadaire; acier, noir / tissu avec des feuilles de bam, blanc, vert

H 1465, Ø 420, Base: Ø 250



E27



1x 25W



9 002759 439453

Ø 420



H 1465



Ø 250



PURE
COLLECTION



43939



43935



43938

43939 BUTTERBURN

floor light; steel, black / fabric with birch leaves, beige, green
Stehleuchte; Stahl, schwarz / Textil mit Birkenblättern, beige, grün
lampadaire; acier, noir / tissu avec des feuilles de bou, beige, vert

H 1620, Ø 360, Base: Ø 320



E27 1x 25W



9 002759 439392

43938 BUTTERBURN

table light; steel, black / fabric with birch leaves, beige, green
Tischleuchte; Stahl, schwarz / Textil mit Birkenblättern, beige, grün
luminaire de table; acier, noir / tissu avec des feuilles de bou, beige, vert

H 475, Ø 180, Base: Ø 180



E27 1x 25W



9 002759 439385

43935 BUTTERBURN

ceiling light; steel, black / fabric with birch leaves, beige, green
Deckenleuchte; Stahl, schwarz / Textil mit Birkenblättern, beige, grün
plafonnier; acier, noir / tissu avec des feuilles de bou, beige, vert

H 235, Ø 380



E27 1x 25W

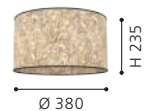

9 002759 439354

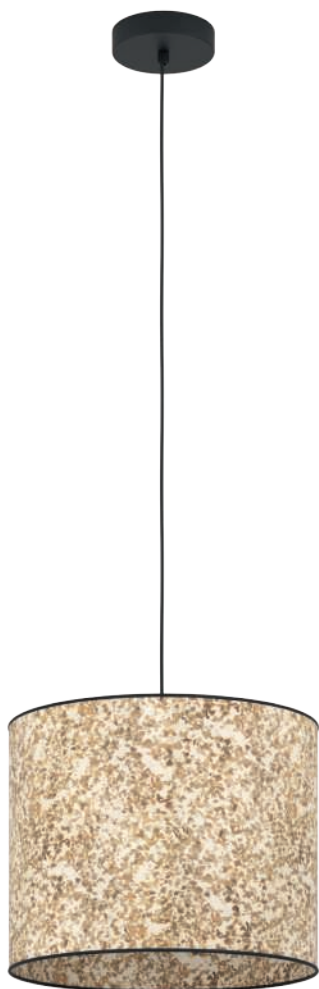

43936



43937

43936 BUTTERBURN

pendant light; steel, black / fabric with birch leaves, beige, green

Hängeleuchte; Stahl, schwarz / Textil mit Birkenblättern, beige, grün

luminaire en suspension; acier, noir / tissu avec des feuilles de bouleau, beige, vert

H 1100, Ø 360



E27



1x 25W



9 002759 439361



43937 BUTTERBURN

pendant light; steel, black / fabric with birch leaves, beige, green

Hängeleuchte; Stahl, schwarz / Textil mit Birkenblättern, beige, grün

luminaire en suspension; acier, noir / tissu avec des feuilles de bouleau, beige, vert

L 860, B 180, H 1100



E27



3x 25W



9 002759 439378



DESIGN
HIGHLIGHT
DETAIL

DETAIL BUTTERBURN

Dried birch leaves on flax fleece - a piece of nature for your own four walls.

Getrocknete Birkenblätter auf Flachsvlies - ein Stück Natur für Ihre eigenen vier Wände.

Feuilles de bouleau séchées sur voile de lin - un peu de nature pour vos propres murs.



44103 BELGRAVE

table light; steel, black / paper, white
Tischleuchte; Stahl, schwarz / Papier, weiss
luminaire de table; acier, noir / papier, blanc

H 440, Ø 180, Base: Ø 220



E27 1x 40W



9 002759 441036



44102 BELGRAVE

pendant light; steel, black / paper, white
Hängeleuchte; Stahl, schwarz / Papier, weiss
luminaire en suspension; acier, noir / papier, blanc

L 880, B 180, H 1100



E27 3x 40W



9 002759 441029



44104 BELGRAVE

floor light; steel, black / paper, white
Stehleuchte; Stahl, schwarz / Papier, weiss
lampadaire; acier, noir / papier, blanc

H 1415, Ø 300, Base: Ø 720



E27 1x 60W



9 002759 441043



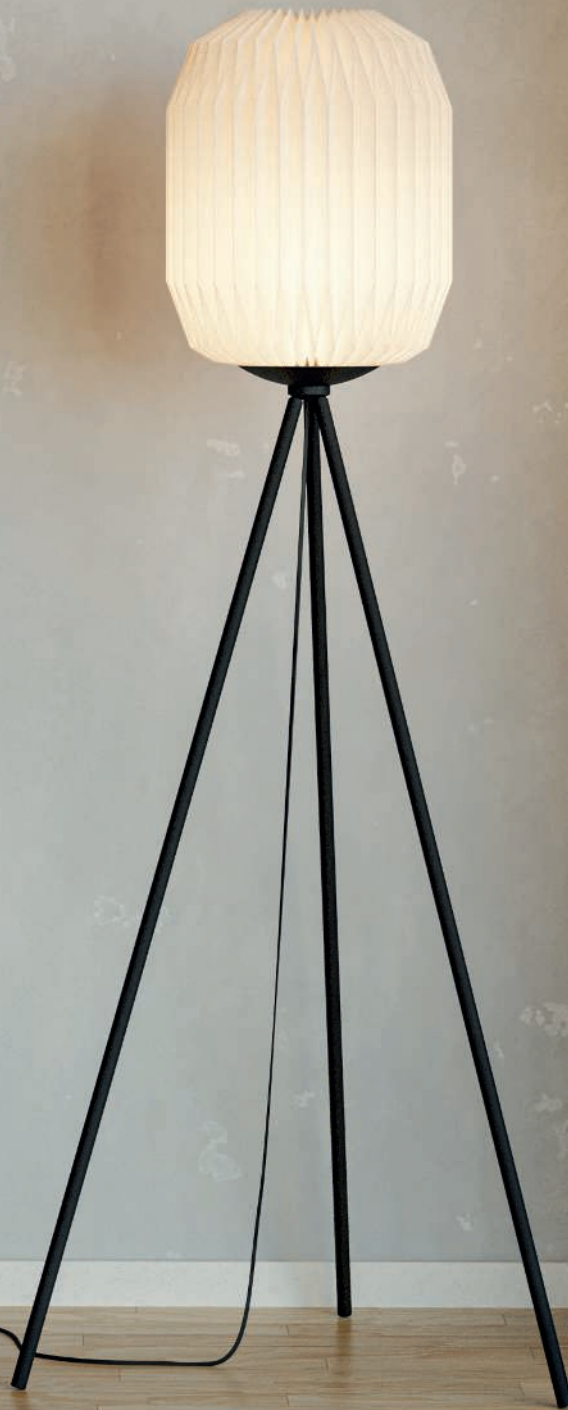
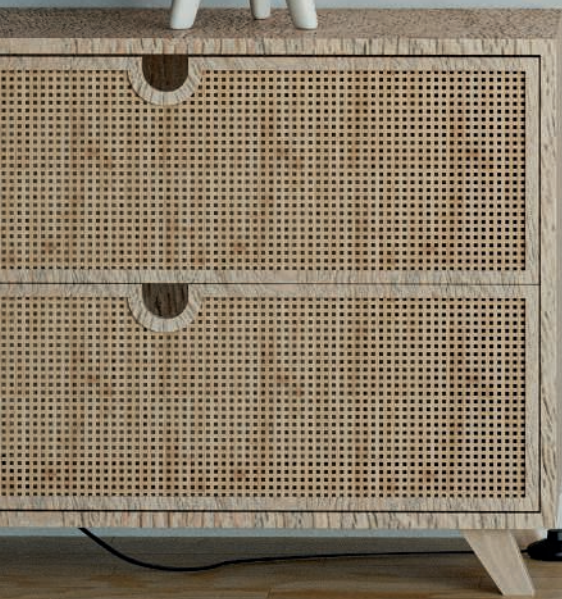

44104





43933



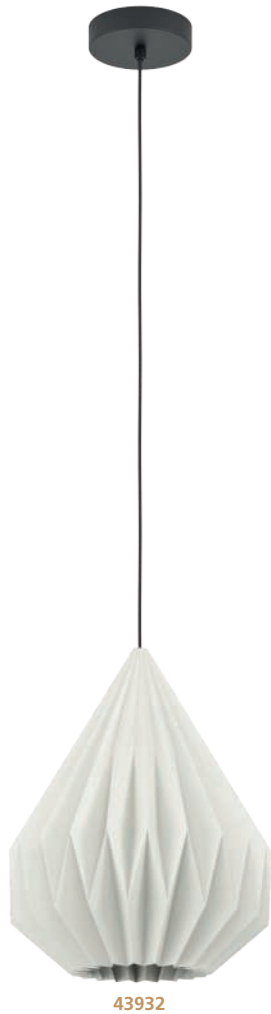

43932

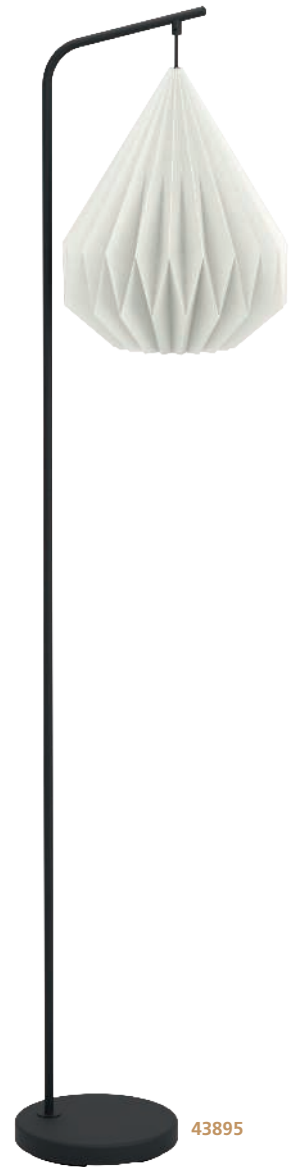

43895

43933 MINTING

pendant light; steel, black / paper, white
 Hängeleuchte; Stahl, schwarz / Papier, weiss
 luminaire en suspension; acier, noir / papier, blanc

H 1100, Ø 450



E27



1x 25W



9 002759 439330



H 1100

Ø 450

43932 MINTING

pendant light; steel, black / paper, white
 Hängeleuchte; Stahl, schwarz / Papier, weiss
 luminaire en suspension; acier, noir / papier, blanc

H 1100, Ø 310



E27



1x 25W



9 002759 439323



H 1100

Ø 310

43895 MINTING

floor light; steel, black / paper, white
 Stehleuchte; Stahl, schwarz / Papier, weiss
 lampadaire; acier, noir / papier, blanc

L 365, B 300, H 1585, Base: Ø 230



E27



1x 25W



9 002759 438951



L 365

Ø 230

H 1585



44063



DESIGN
HIGHLIGHT
DETAIL



44064



44063 SUMMERHILL

ceiling light; wood, steel, brown / paper, white
Deckenleuchte; Holz, Stahl, braun / Papier, weiss
plafonnier; bois, acier, marron / papier, blanc

H 245, Ø 400



E27 1x 40W



9 002759 440633

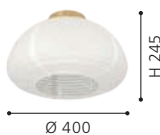

44064 SUMMERHILL

pendant light; steel, wood, white, brown / paper, white
Hängeleuchte; Stahl, Holz, weiss, braun / Papier, weiss
luminaire en suspension; acier, bois, blanc, marron / papier, blanc

H 1100, Ø 400



E27 1x 40W



9 002759 440640



44065 SUMMERHILL

pendant light; steel, wood, white, brown / paper, white
Hängeleuchte; Stahl, Holz, weiss, braun / Papier, weiss
luminaire en suspension; acier, bois, blanc, marron / papier, blanc

H 1100, Ø 550



E27 1x 40W



9 002759 440657





44065





44066



44067



44066 SUMMERHILL

pendant light; steel, wood, white, brown / paper, white
 Hängeleuchte; Stahl, Holz, weiss, braun / Papier, weiss
 luminaire en suspension; acier, bois, blanc, marron / papier, blanc

L 925, B 225, H 1100



E27



3x 40W



9 002759 440664

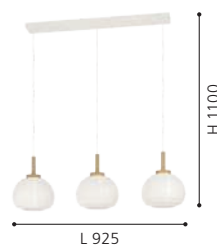

44067 SUMMERHILL

table light; wood, steel, brown / paper, white
 Tischleuchte; Holz, Stahl, braun / Papier, weiss
 luminaire de table; bois, acier, marron / papier, blanc

H 200, Ø 225, Base: Ø 100



E27



1x 40W



9 002759 440671





44014



44015



44014 ASBY

table light; wood, light brown
Tischleuchte; Holz, hellbraun
luminaire de table; bois, marron clair

H 100, Ø 85



E27



1x 40W



9 002759 440145



Ø 85

H 100

44015 ASBY

table light; wood, dark brown
Tischleuchte; Holz, dunkelbraun
luminaire de table; bois, marron foncé

H 100, Ø 85



E27



1x 40W



9 002759 440152



Ø 85

H 100

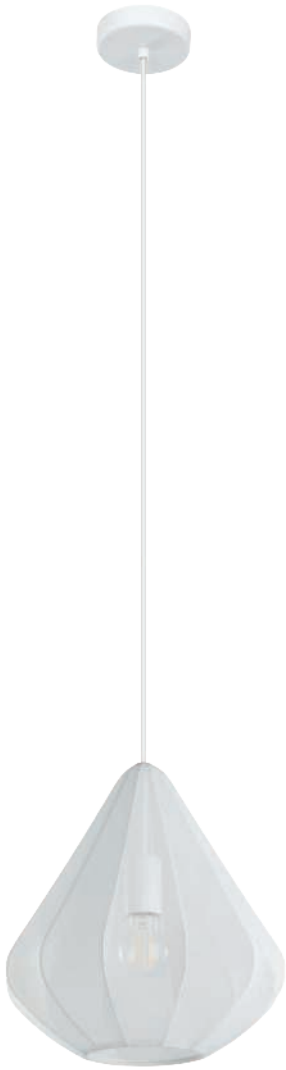

43996

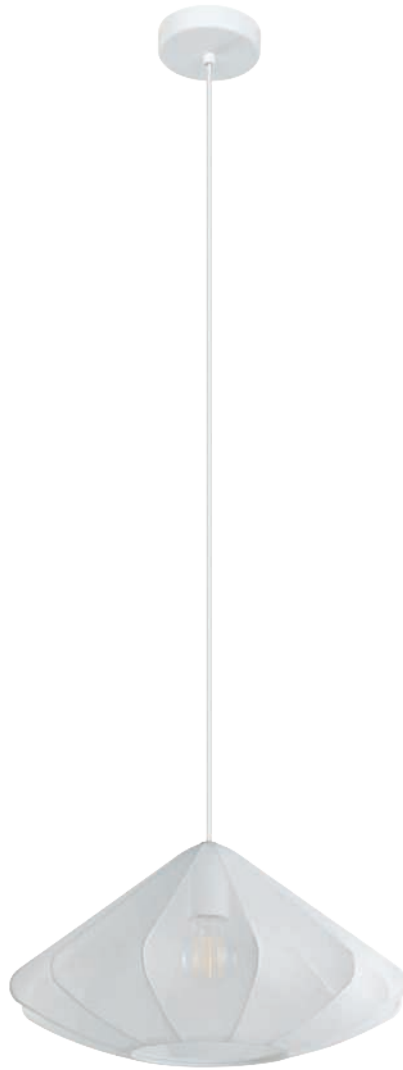

43997

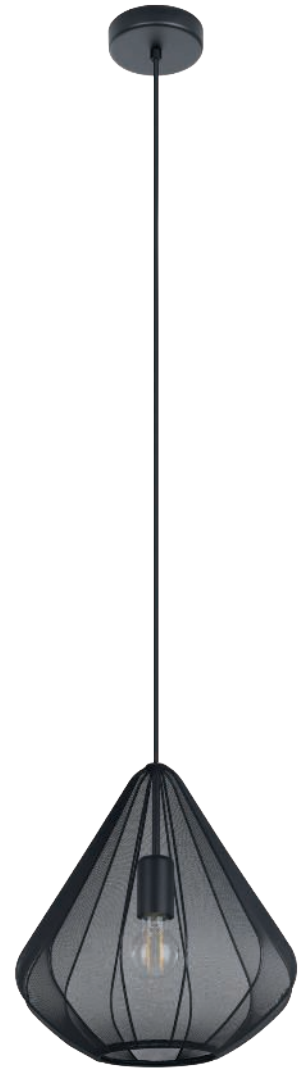

43994

43996 DOLWEN

pendant light; steel, white / fabric, white
 Hängeleuchte; Stahl, weiss / Textil, weiss
 luminaire en suspension; acier, blanc / tissu, blanc

H 1100, Ø 335



E27 1x 40W



9 002759 439965



43997 DOLWEN

pendant light; steel, white / fabric, white
 Hängeleuchte; Stahl, weiss / Textil, weiss
 luminaire en suspension; acier, blanc / tissu, blanc

H 1100, Ø 425



E27 1x 40W



9 002759 439972



43994 DOLWEN

pendant light; steel, black / fabric, black
 Hängeleuchte; Stahl, schwarz / Textil, schwarz
 luminaire en suspension; acier, noir / tissu, noir

H 1100, Ø 335



E27 1x 40W



9 002759 439941





43995

43995 DOLWEN

pendant light; steel, black / fabric, black
Hängeleuchte; Stahl, schwarz / Textil, schwarz
luminaire en suspension; acier, noir / tissu, noir

H 1100, Ø 425



E27



1x 40W



9 002759 439958

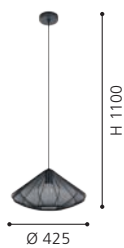



43961

43961 BARLASTON

pendant light; steel, black / fabric, grey
Hängeleuchte; Stahl, schwarz / Textil, grau
luminaire en suspension; acier, noir / tissu, gris

H 1100, Ø 450



E27



1x 40W



DESIGN
HIGHLIGHT
DETAIL



9 002759 439613

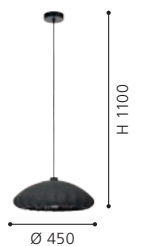



43962



43973

43946

43962 BARLASTON

pendant light; steel, black / fabric, grey
 Hängeleuchte; Stahl, schwarz / Textil, grau
 luminaire en suspension; acier, noir / tissu, gris

L 880, B 180, H 1100



E27



3x 40W



9 002759 439620

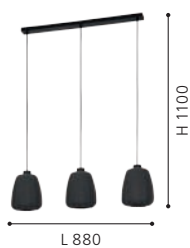

L 880

H 1100

43946 BARLASTON

table light; steel, black / fabric, grey
 Tischleuchte; Stahl, schwarz / Textil, grau
 luminaire de table; acier, noir / tissu, gris

H 390, Ø 180, Base: Ø 120



E27



1x 40W



9 002759 439460



Ø 120

H 390

Ø 180

43973 BARLASTON

pendant light; steel, black / fabric, grey
 Hängeleuchte; Stahl, schwarz / Textil, grau
 luminaire en suspension; acier, noir / tissu, gris

H 1100, Ø 350



E27



1x 40W



9 002759 439736



Ø 350

H 1100

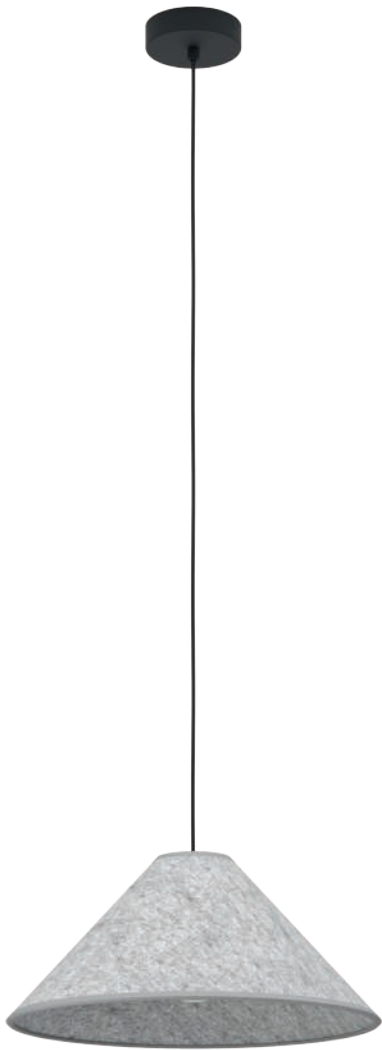

43984



43985

43984 ALSAGER

pendant light; steel, black / felt, grey
 Hängeleuchte; Stahl, schwarz / Filz, grau
 luminaire en suspension; acier, noir / feutre, gris

H 1100, Ø 410



E27 1x 40W



9 002759 439842

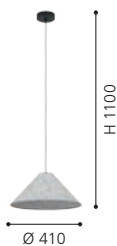

43985 ALSAGER

pendant light; steel, black / felt, grey
 Hängeleuchte; Stahl, schwarz / Filz, grau
 luminaire en suspension; acier, noir / feutre, gris

L 910, B 210, H 1100



E27 3x 40W



9 002759 439859



43987 ALSAGER

floor light; steel, black / felt, grey
 Stehleuchte; Stahl, schwarz / Filz, grau
 lampadaire; acier, noir / feutre, gris

L 505, B 210, H 1700, Base: Ø 300



E27 1x 40W



9 002759 439873

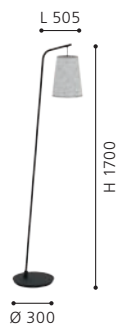



43987



43986

43986 ALSAGER

table light; steel, black / felt, grey
 Tischleuchte; Stahl, schwarz / Filz, grau
 luminaire de table; acier, noir / feutre, gris

H 395, Ø 200, Base: Ø 150



E27



1x 40W



9 002759 439866

Ø 200



H 395



Ø 150

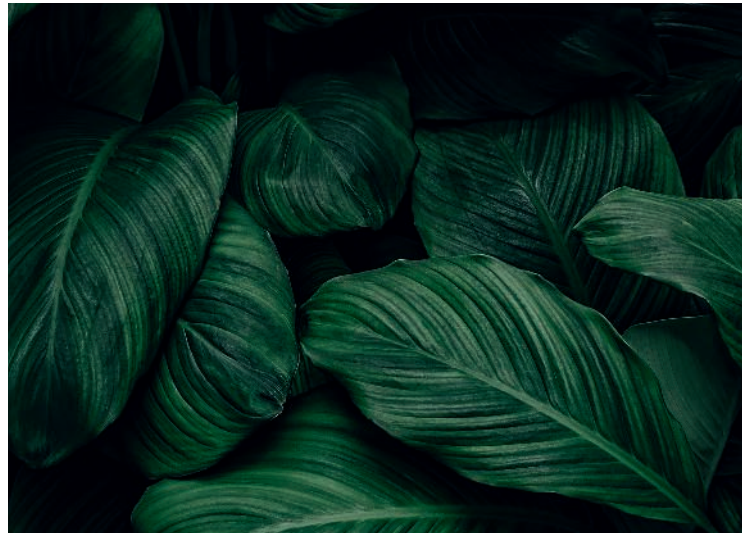

! NATURE

#PURE
#GREEN

Bring the warmth and comfort of natural elements into your home. The back-to-nature trend incorporates designs that use natural materials, harmonious colour combinations, and simple, neutral shapes. A lamp from the EGLO Nature range will increase the comfort of any living space, no matter what interior design style you prefer.

Holen Sie sich pure Gemütlichkeit in Ihr zu Hause, ganz getreu dem Motto „back to nature“. Der Nature-Trend umfasst Designs mit natürlichen Materialien, aufeinander abgestimmten Farbkombinationen und neutralen sowie einfachen Formen. Egal welchen Einrichtungsstil Sie bevorzugen, mit einer EGLO Leuchte aus der Kategorie Nature steigern Sie das Wohlbefinden im Wohnraum.

Faites entrer le confort absolu dans votre maison, fidèle à la devise „retour à la nature“. La tendance nature comprend des designs avec des matériaux naturels, des combinaisons de couleurs coordonnées et des formes neutres et simples. Quel que soit le style d'ameublement que vous préférez, avec une lampe EGLO de la catégorie Nature, vous augmentez le bien-être dans le salon.



ALDERNEY 204 	ADWICKLE 205 	PERSLEY 206-207 	LAVISTER 208 	SIRUELA 210-211 	MARYWELL 212-213 	ANWICK 214-215 	ANWICK 1 216 		
HYKEHAM 218-219 	LEOMINSTER 219 	GLYNEATH 220 	LYDNEY 220 	BORDESLEY 222-223 	DEMBLEBY 224-225 	CLAVERDON 225 	AYESGARTH 226 		
AMSFIELD 227 	AMSFIELD 1 228 	KIRKCOLM 230 	AYCLIFFE 230 	HAXEY 230 	HETTONLE 231 	MEDJOUNA 232 	MARFORD 232 		
TABLEY 234-235 	ROSLEY 236-237 	SURFLEET 238 							



 This product is available in different colors and shapes./ Dieser Artikel ist in unterschiedlichen Farben und Formen verfügbar.
Cet article est disponible en différentes couleurs et formes.



43785



43784



43786

43785 ALDERNEY

pendant light; steel, black / textile thread, natural
Hängeleuchte; Stahl, schwarz / Textilfaden, natur
luminaire en suspension; acier, noir / fil textile, nature

H 1100, Ø 300



E27 1x 40W



9 002759 437855



43784 ALDERNEY

ceiling light; steel, black / textile thread, natural
Deckenleuchte; Stahl, schwarz / Textilfaden, natur
plafonnier; acier, noir / fil textile, nature

H 240, Ø 480



E27 1x 40W



9 002759 437848

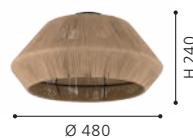

43786 ALDERNEY

pendant light; steel, black / textile thread, natural
Hängeleuchte; Stahl, schwarz / Textilfaden, natur
luminaire en suspension; acier, noir / fil textile, nature

L 900, B 200, H 1100



E27 3x 40W



9 002759 437862





43775



43777



43776

43775 ADWICKLE

ceiling light; steel, black / fabric, natural
Deckenleuchte; Stahl, schwarz / Textil, natur
plafonnier; acier, noir / tissu, nature

H 260, Ø 445



E27



1x 40W



9 002759 437756



Ø 445

H 260

43777 ADWICKLE

pendant light; steel, black / fabric, natural
Hängeleuchte; Stahl, schwarz / Textil, natur
luminaire en suspension; acier, noir / tissu, nature

L 870, B 145, H 1100



E27



3x 40W



9 002759 437770



L 870

H 1100

43776 ADWICKLE

pendant light; steel, black / fabric, natural
Hängeleuchte; Stahl, schwarz / Textil, natur
luminaire en suspension; acier, noir / tissu, nature

L 170, B 145, H 1100



E27



1x 40W



9 002759 437763



L 170

H 1100



44105



44108



44107



44105 PERSLEY

pendant light; steel, black / paper, black
Hängeleuchte; Stahl, schwarz / Papier, schwarz
luminaire en suspension; acier, noir / papier, noir

H 1100, Ø 220



E27 1x 60W



9 002759 441050



44108 PERSLEY

floor light; steel, black / paper, black
Stehleuchte; Stahl, schwarz / Papier, schwarz
lampadaire; acier, noir / papier, noir

H 1555, Ø 220, Base: Ø 230

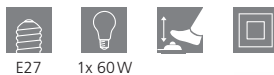

E27 1x 60W



9 002759 441081



44107 PERSLEY

table light; steel, black / paper, black
Tischleuchte; Stahl, schwarz / Papier, schwarz
luminaire de table; acier, noir / papier, noir

H 275, Ø 220, Base: Ø 120

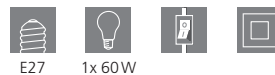

E27 1x 60W



9 002759 441074





44106



44106 PERSLEY

pendant light; steel, black / paper, black
Hängeleuchte; Stahl, schwarz / Papier, schwarz
luminaire en suspension; acier, noir / papier, noir

L 920, B 220, H 1100



E27



3x 60W



9 002759 441067



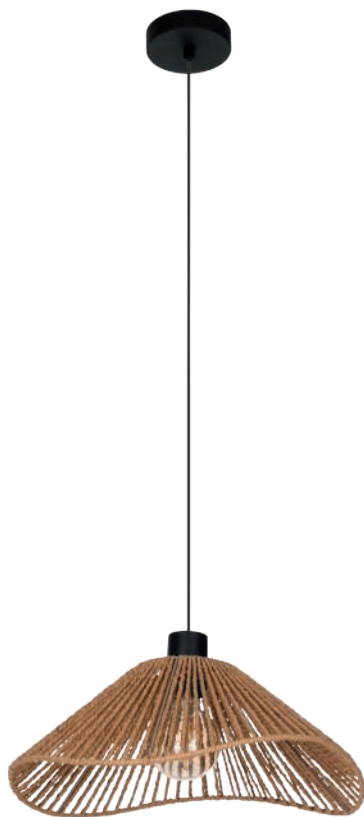

44072



44073



44072 LAVISTER

pendant light; steel, black / paper, natural
Hängeleuchte; Stahl, schwarz / Papier, natur
luminaire en suspension; acier, noir / papier, nature

H 1100, Ø 390



E27 1x 60W



9 002759 440725



44073 LAVISTER

pendant light; steel, black / paper, natural
Hängeleuchte; Stahl, schwarz / Papier, natur
luminaire en suspension; acier, noir / papier, nature

L 910, B 210, H 1100



E27 3x 60W



9 002759 440732



44071 LAVISTER

ceiling light; steel, black / paper, natural
Deckenleuchte; Stahl, schwarz / Papier, natur
plafonnier; acier, noir / papier, nature

H 175, Ø 390



E27 1x 60W



9 002759 440718





44071





31966



31964



31965



31966 SIRUELA

floor light; steel, black / paper, natural
 Stehleuchte; Stahl, schwarz / Papier, natur
 lampadaire; acier, noir / papier, nature

L 480, B 560, H 1600, Base: Ø 230



E27

1x 42W



9 002759 319663

31964 SIRUELA

wall light; steel, black / paper, natural
 Wandleuchte; Stahl, schwarz / Papier, natur
 Applique; acier, noir / papier, nature

L 365, H 250, A 350



E27

1x 42W

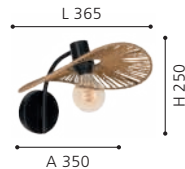

9 002759 319649

31965 SIRUELA

table light; steel, black / paper, natural
 Tischleuchte; Stahl, schwarz / Papier, natur
 luminaire de table; acier, noir / papier, nature

L 320, B 365, H 465, Base: Ø 180



E27

1x 42W



9 002759 319656



31991 SIRUELA

pendant light; steel, black / paper, natural
 Hängeleuchte; Stahl, schwarz / Papier, natur
 luminaire en suspension; acier, noir / papier, nature

L 560, B 400, H 1100



E27 1x 42W



9 002759 319915



31992 SIRUELA

pendant light; steel, black / paper, natural
 Hängeleuchte; Stahl, schwarz / Papier, natur
 luminaire en suspension; acier, noir / papier, nature

L 800, B 600, H 1100



E27 1x 42W



9 002759 319922



31961 SIRUELA

ceiling light; steel, black / paper, natural
 Deckenleuchte; Stahl, schwarz / Papier, natur
 plafonnier; acier, noir / papier, nature

L 560, B 400, H 160



E27 1x 42W



9 002759 319618





44044



44045



44043

44044 MARYWELL

pendant light; steel, black / wood, brown
 Hängeleuchte; Stahl, schwarz / Holz, braun
 luminaire en suspension; acier, noir / bois, marron

L 500, B 345, H 1100



E27 1x 40W



9 002759 440442



44045 MARYWELL

wall light; steel, black / wood, brown
 Wandleuchte; Stahl, schwarz / Holz, braun
 Applique; acier, noir / bois, marron

L 200, H 300, A 115



E27 1x 40W



9 002759 440459



44043 MARYWELL

ceiling light; steel, black / wood, brown
 Deckenleuchte; Stahl, schwarz / Holz, braun
 plafonnier; acier, noir / bois, marron

L 500, B 345, H 165



E27 1x 40W



9 002759 440435



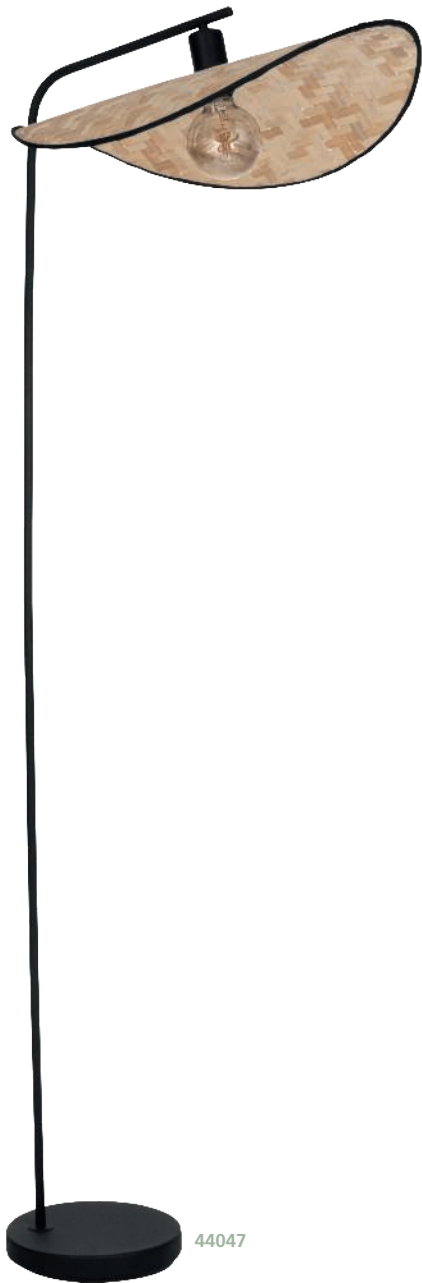

44047



44046

44047 MARYWELL

floor light; steel, black / wood, brown
 Stehleuchte; Stahl, schwarz / Holz, braun
 lampadaire; acier, noir / bois, marron

L 555, B 345, H 1595, Base: Ø 230



E27



1x 40W

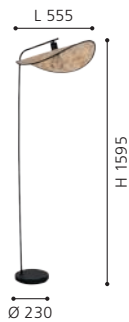

9 002759 440473

44046 MARYWELL

table light; steel, black / wood, brown
 Tischleuchte; Stahl, schwarz / Holz, braun
 luminaire de table; acier, noir / bois, marron

L 290, B 300, H 465, Base: Ø 180



E27



1x 40W



9 002759 440466

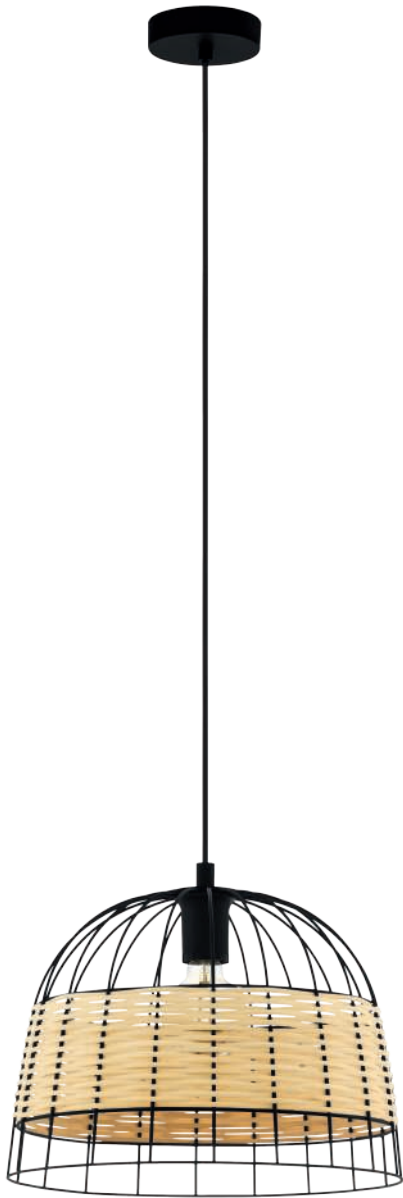

43311



43313

43311 ANWICK

pendant light; steel, black / rattan, natural
 Hängeleuchte; Stahl, schwarz / Rattan, natur
 luminaire en suspension; acier, noir / rotin, nature

H 1100, Ø 370



E27



1x 40W



9 002759 433116



43313 ANWICK

pendant light; steel, black / rattan, natural
 Hängeleuchte; Stahl, schwarz / Rattan, natur
 luminaire en suspension; acier, noir / rotin, nature

L 880, B 180, H 1100



E27



3x 40W



9 002759 433130





43398



43312



43398 ANWICK

ceiling light; steel, black / rattan, natural
Deckenleuchte; Stahl, schwarz / Rattan, natur
plafonnier; acier, noir / rotin, nature

H 265, Ø 380



E27



1x 60W



9 002759 433987

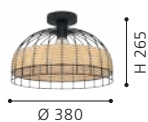

43312 ANWICK

pendant light; steel, black / rattan, natural
Hängeleuchte; Stahl, schwarz / Rattan, natur
luminaire en suspension; acier, noir / rotin, nature

H 1100, Ø 500



E27



1x 40W



9 002759 433123





43325



43326

43325 ANWICK 1

spot; steel, black / rattan, natural
Spot; Stahl, schwarz / Rattan, natur
spot; acier, noir / rotin, nature

L 480, B 140, H 240



E27



2x 40W



9 002759 433253

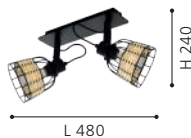

L 480

H 240

43326 ANWICK 1

spot; steel, black / rattan, natural
Spot; Stahl, schwarz / Rattan, natur
spot; acier, noir / rotin, nature

L 670, B 140, H 240



E27



3x 40W



9 002759 433260



L 670

H 240

43324 ANWICK 1

spot; steel, black / rattan, natural
Spot; Stahl, schwarz / Rattan, natur
spot; acier, noir / rotin, nature

L 140, H 200



E27



1x 40W



9 002759 433246

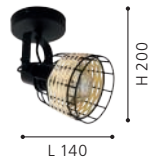

L 140

H 200



43324





43851



43854



43853

43851 HYKEHAM

ceiling light; steel, black / wood, natural
Deckenleuchte; Stahl, schwarz / Holz, natur
plafonnier; acier, noir / bois, nature

H 210, Ø 380



E27 1x 40W



9 002759 438517



43854 HYKEHAM

table light; steel, black / wood, natural
Tischleuchte; Stahl, schwarz / Holz, natur
luminaire de table; acier, noir / bois, nature

H 570, Ø 210, Base: Ø 285

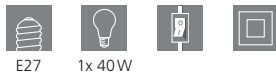

E27 1x 40W



9 002759 438548



43853 HYKEHAM

pendant light; steel, black / wood, natural
Hängeleuchte; Stahl, schwarz / Holz, natur
luminaire en suspension; acier, noir / bois, nature

L 910, B 210, H 1100



E27 3x 40W



9 002759 438531





43855

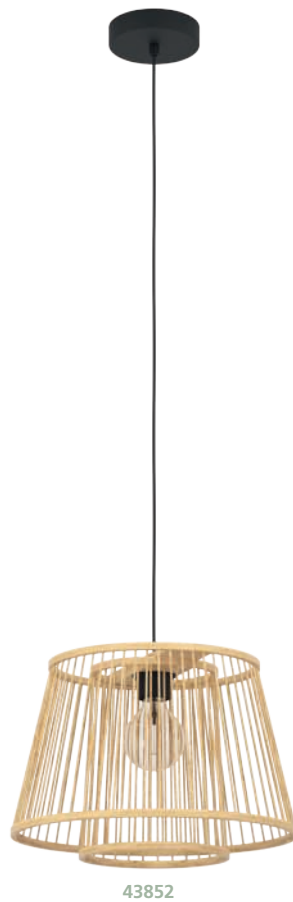

43852



43883

43855 HYKEHAM

floor light; steel, black / wood, natural
 Stehleuchte; Stahl, schwarz / Holz, natur
 lampadaire; acier, noir / bois, nature

H 1295, Ø 380, Base: Ø 630



E27 1x 40W



9 002759 438555



43852 HYKEHAM

pendant light; steel, black / wood, natural
 Hängeleuchte; Stahl, schwarz / Holz, natur
 luminaire en suspension; acier, noir / bois, nature

H 1100, Ø 380



E27 1x 40W



9 002759 438524



43883 LEOMINSTER

wall/ceiling light; steel, black / wood, natural
 Wand- / Deckenleuchte; Stahl, schwarz / Holz, natur
 Applique/Plafonnier; acier, noir / bois, nature

H 90, Ø 450



E27 1x 40W



9 002759 438838





43872



DESIGN
HIGHLIGHT
DETAIL

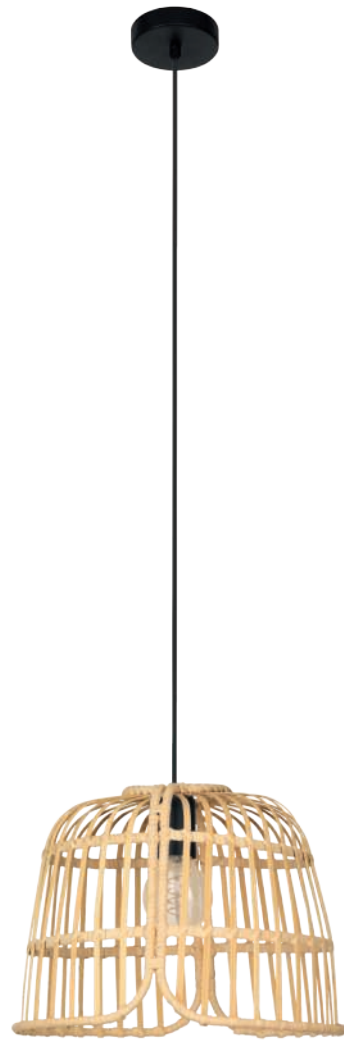

43873

43872 GLYNEATH

ceiling light; steel, black / wood, natural
Deckenleuchte; Stahl, schwarz / Holz, natur
plafonnier; acier, noir / bois, nature

H 205, Ø 375



E27 1x 40W



9 002759 438722



43873 GLYNEATH

pendant light; steel, black / wood, natural
Hängeleuchte; Stahl, schwarz / Holz, natur
luminaire en suspension; acier, noir / bois, nature

H 1100, Ø 375



E27 1x 40W



9 002759 438739



44012 LYDNEY

pendant light; steel, black / wood, brown
Hängeleuchte; Stahl, schwarz / Holz, braun
luminaire en suspension; acier, noir / bois, marron

H 1100, Ø 570



E27 1x 40W



9 002759 440121





44012





43216

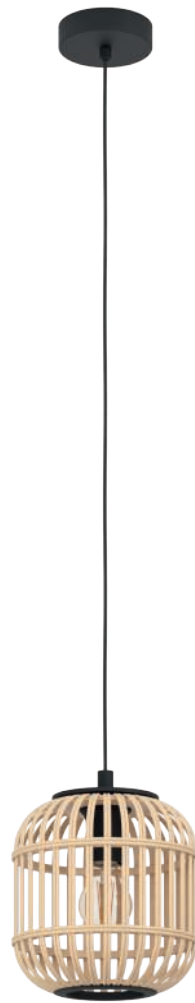

43231



43218

43216 BORDESLEY

pendant light; steel, black / wood, natural
Hängeleuchte; Stahl, schwarz / Holz, natur
luminaire en suspension; acier, noir / bois, nature

H 1100, Ø 350



E27 1x 28W



9 002759 432164



43231 BORDESLEY

pendant light; steel, black / wood, natural
Hängeleuchte; Stahl, schwarz / Holz, natur
luminaire en suspension; acier, noir / bois, nature

H 1100, Ø 210



E27 1x 28W



9 002759 432317



43218 BORDESLEY

table light; steel, black / wood, natural
Tischleuchte; Stahl, schwarz / Holz, natur
luminaire de table; acier, noir / bois, nature

H 400, Ø 210, Base: Ø 190



E27 1x 28W



9 002759 432188





43217



43219

43217 BORDESLEY

pendant light; steel, black / wood, natural
 Hängeleuchte; Stahl, schwarz / Holz, natur
 luminaire en suspension; acier, noir / bois, nature

L 910, B 210, H 1100



E27



3x 28W



9 002759 432171



H 1100

L 910

43219 BORDESLEY

floor light; steel, black / wood, natural
 Stehleuchte; Stahl, schwarz / Holz, natur
 lampadaire; acier, noir / bois, nature

H 1390, Ø 350, Base: Ø 560



E27



1x 28W



9 002759 432195



Ø 350

H 1390

Ø 560



43262



43263

43262 DEMBLEBY

pendant light; steel, black / wood, natural
 Hängeleuchte; Stahl, schwarz / Holz, natur
 luminaire en suspension; acier, noir / bois, nature

L 900, B 200, H 1100



E27



3x 40W



9 002759 432621



43263 DEMBLEBY

table light; steel, black / wood, natural
 Tischleuchte; Stahl, schwarz / Holz, natur
 luminaire de table; acier, noir / bois, nature

H 250, Ø 200, Base: Ø 115



E27



1x 40W



9 002759 432638



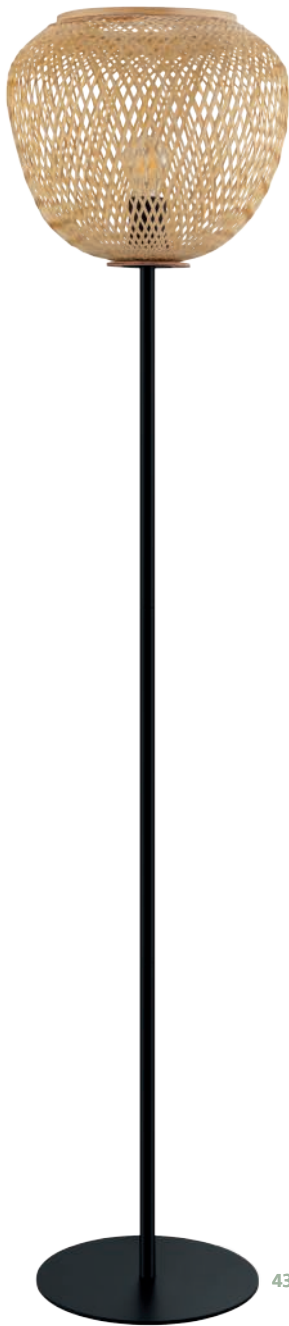

43264

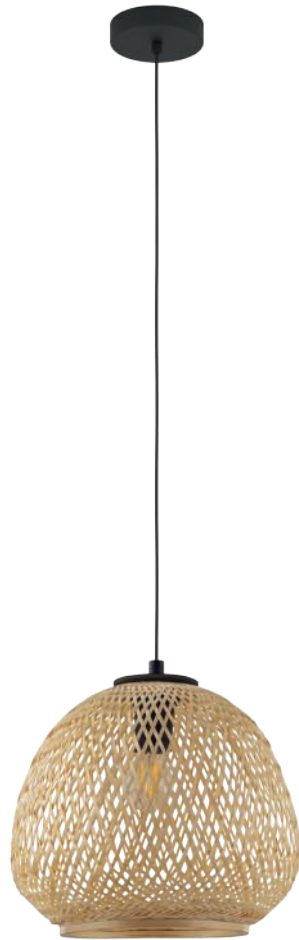

43261

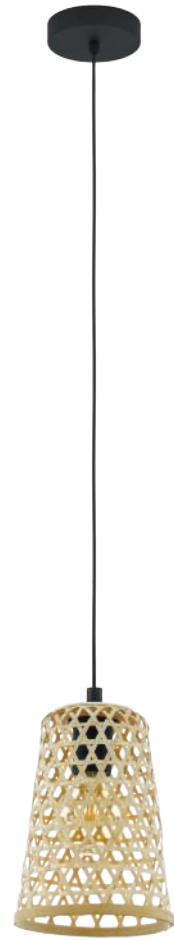

43252

43264 DEMBLEBY

floor light; steel, black / wood, natural
 Stehleuchte; Stahl, schwarz / Holz, natur
 lampadaire; acier, noir / bois, nature

H 1500, Ø 320, Base: Ø 275



E27 1x 40W

Ø 320



H 1500

Ø 275



9 002759 432645

43261 DEMBLEBY

pendant light; steel, black / wood, natural
 Hängeleuchte; Stahl, schwarz / Holz, natur
 luminaire en suspension; acier, noir / bois, nature

H 1100, Ø 320



E27 1x 40W

H 1100



Ø 320



9 002759 432614

43252 CLAVERDON

pendant light; steel, black / wood, natural
 Hängeleuchte; Stahl, schwarz / Holz, natur
 luminaire en suspension; acier, noir / bois, nature

H 1100, Ø 180



E27 1x 40W

H 1100



Ø 180



9 002759 432522



43866



43867

43866 AYESGARTH

pendant light; steel, black / wood, natural
Hängeleuchte; Stahl, schwarz / Holz, natur
luminaire en suspension; acier, noir / bois, nature

H 1100, Ø 330



E27



1x 40W



9 002759 438661



43867 AYESGARTH

pendant light; steel, black / wood, natural
Hängeleuchte; Stahl, schwarz / Holz, natur
luminaire en suspension; acier, noir / bois, nature

L 910, B 210, H 1100



E27



3x 40W



9 002759 438678





49772



43723



49771

49772 AMSFIELD

pendant light; steel, brown / wood, brown
Hängeleuchte; Stahl, braun / Holz, braun
luminaire en suspension; acier, marron / bois, marron

H 1100, Ø 350



E27 1x 60W



9 002759 497729



43723 AMSFIELD

ceiling light; steel, black / wood, brown
Deckenleuchte; Stahl, schwarz / Holz, braun
plafonnier; acier, noir / bois, marron

H 285, Ø 450



E27 1x 40W



9 002759 437237

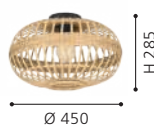

49771 AMSFIELD

pendant light; steel, brown / wood, brown
Hängeleuchte; Stahl, braun / Holz, braun
luminaire en suspension; acier, marron / bois, marron

H 1100, Ø 380



E27 1x 60W



9 002759 497712





43863



43864

43863 AMSFIELD 1

pendant light; steel, black / wood, natural
Hängeleuchte; Stahl, schwarz / Holz, natur
luminaire en suspension; acier, noir / bois, nature

L 960, B 260, H 1100



E27 3x 40W



9 002759 438630

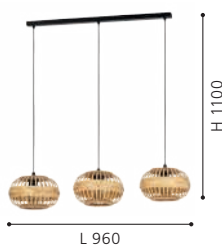

43864 AMSFIELD 1

pendant light; steel, black / wood, natural
Hängeleuchte; Stahl, schwarz / Holz, natur
luminaire en suspension; acier, noir / bois, nature

H 1100, Ø 480



E27 3x 40W



9 002759 438647



43865 AMSFIELD 1

table light; steel, black / wood, natural
Tischleuchte; Stahl, schwarz / Holz, natur
luminaire de table; acier, noir / bois, nature

H 410, Ø 260, Base: Ø 200



E27 1x 40W



9 002759 438654

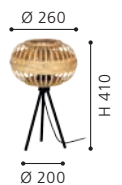



43865



43113

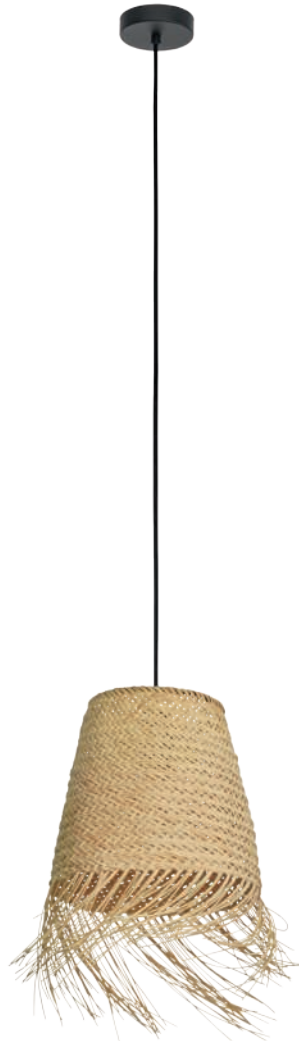

43871

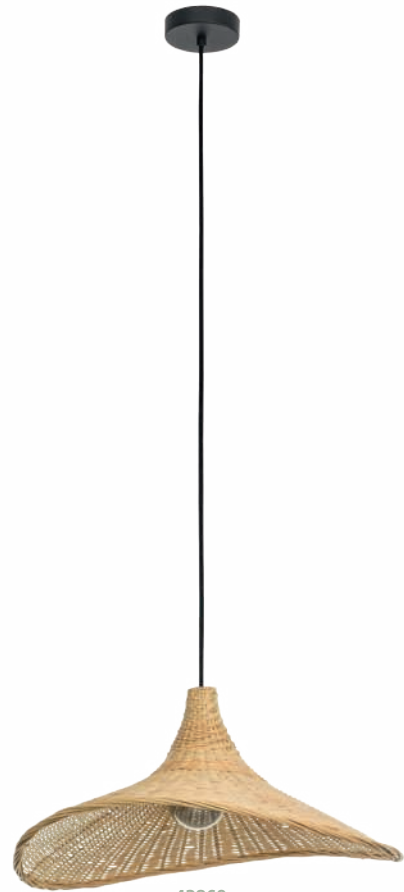

43869

43113 KIRKCOLM

pendant light; steel, satin nickel / wood, natural
 Hängeleuchte; Stahl, nickel-matt / Holz, natur
 luminaire en suspension; acier, nickel mat / bois, nature

H 1100, Ø 300



E27 1x 60W



9 002759 431136



43871 AYCLIFFE

pendant light; steel, black / wood, natural
 Hängeleuchte; Stahl, schwarz / Holz, natur
 luminaire en suspension; acier, noir / bois, nature

H 1100, Ø 300



E27 1x 40W



9 002759 438715



43869 HAXEY

pendant light; steel, black / wood, natural
 Hängeleuchte; Stahl, schwarz / Holz, natur
 luminaire en suspension; acier, noir / bois, nature

H 1100, Ø 500



E27 1x 40W



9 002759 438692

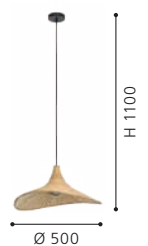



43868

43868 HETTONLE

pendant light; steel, black / wood, natural
Hängeleuchte; Stahl, schwarz / Holz, natur
luminaire en suspension; acier, noir / bois, nature

H 1100, Ø 420



E27



1x 40W



9 002759 438685





43393



44095



43393 MEDIUMA

pendant light; steel, beige / glass vaporized, seagrass, matte grey

Hängeleuchte; Stahl, beige / Glas bedampft, Seegrass, goldfarben, braun

luminaire en suspension; acier, beige / Verre vaporisé, gazon, doré, marron
H 1100, Ø 230



E27 1x 40W



9 002759 433932

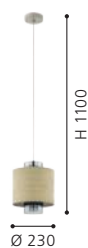

44095 MARFORD

ceiling light; steel, black / bast, natural

Deckenleuchte; Stahl, schwarz / Bast, natur

plafonnier; acier, noir / raphia, nature

H 190, Ø 500



E27 1x 60W



9 002759 440954



44096 MARFORD

pendant light; steel, black / bast, natural

Hängeleuchte; Stahl, schwarz / Bast, natur

luminaire en suspension; acier, noir / raphia, nature

H 1100, Ø 500



E27 1x 60W



9 002759 440961





44096



43974



43977



43978

43974 TABLEY

ceiling light; steel, black / fabric, wood, nature, brown
Deckenleuchte; Stahl, schwarz / Textil, Holz, natur, braun
plafonnier; acier, noir / tissu, bois, nature, marron

H 235, Ø 380



E27 1x 40W



9 002759 439743

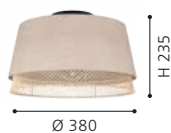

43977 TABLEY

table light; steel, black / fabric, wood, nature, brown
Tischleuchte; Stahl, schwarz / Textil, Holz, natur, braun
luminaire de table; acier, noir / tissu, bois, nature, marron

H 425, Ø 190, Base: Ø 145

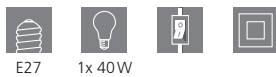

E27 1x 40W



9 002759 439774



43978 TABLEY

floor light; steel, black / fabric, wood, nature, brown
Stehleuchte; Stahl, schwarz / Textil, Holz, natur, braun
lampadaire; acier, noir / tissu, bois, nature, marron

H 1530, Ø 380, Base: Ø 250



E27 1x 40W



9 002759 439781





43976 TABLEY

pendant light; steel, black / fabric, wood, nature, brown
 Hängeleuchte; Stahl, schwarz / Textil, Holz, natur, braun
 luminaire en suspension; acier, noir / tissu, bois, nature, marron

L 890, B 190, H 1100



E27



3x 40W



9 002759 439767



43975 TABLEY

pendant light; steel, black / fabric, wood, nature, brown
 Hängeleuchte; Stahl, schwarz / Textil, Holz, natur, braun
 luminaire en suspension; acier, noir / tissu, bois, nature, marron

H 1100, Ø 380



E27



1x 40W



9 002759 439750





43656



43657



43656 ROSLEY

spot; steel, black / fabric, linen, natural
Spot; Stahl, schwarz / Textil, Leinen, natur
spot; acier, noir / tissu, lin, nature

H 110, Ø 90, A 185



E14



1x 40W



9 002759 436568



A 185

43657 ROSLEY

spot; steel, black / fabric, linen, natural
Spot; Stahl, schwarz / Textil, Leinen, natur
spot; acier, noir / tissu, lin, nature

L 310, B 90, H 185



E14



2x 40W



9 002759 436575



L 310



43658



43659

43658 ROSLEY

spot; steel, black / fabric, linen, natural
 Spot; Stahl, schwarz / Textil, Leinen, natur
 spot; acier, noir / tissu, lin, nature

L 430, B 90, H 185



E14



3x 40W



9 002759 436582



43659 ROSLEY

spot; steel, black / fabric, linen, natural
 Spot; Stahl, schwarz / Textil, Leinen, natur
 spot; acier, noir / tissu, lin, nature

L 750, B 90, H 185



E14



4x 40W



9 002759 436599





DESIGN
HIGHLIGHT
DETAIL



43934

43934 SURFLEET

table light; steel, black / wood, fabric, natural
Tischleuchte; Stahl, schwarz / Holz, Textil, natur
luminaire de table; acier, noir / bois, tissu, nature

H 515, Ø 200, Base: Ø 210



E27 1x 40W



9 002759 439347



43874 SURFLEET

pendant light; steel, black / wood, fabric, natural
Hängeleuchte; Stahl, schwarz / Holz, Textil, natur
luminaire en suspension; acier, noir / bois, tissu, nature

H 1100, Ø 330



E27 1x 40W



9 002759 438746





43874



VINTAGE

#USED #LOOK

Did you know that the word Vintage originally meant „wine harvest“? Vintage style means a piece of furniture built anew but designed in a „used look“. Genuine vintage pieces from the 1920s to 1980s can be found in flea markets or in the attic, by contrast. Genuine or as imitations: Vintage reminds us of the good old days: summer holidays with the grandparents, the first ride in grandpa's vintage car and the best apple pie from grandma's enameled mould. Travel through time, and enjoy feelings of nostalgia with a glass of wine. We recommend accompanying the wine with a taste of our vintage product range.

Wussten Sie, dass das Wort Vintage ursprünglich „Weinlese“ bedeutet? Vom Vintage-Stil spricht man, wenn ein Einrichtungstück neu gebaut, aber im „Used-Look“ designt ist. Echte Vintage-Stücke aus den 20er bis 80er-Jahren findet man hingegen auf Flohmärkten oder am Dachboden. Ob echt oder nachgebaut, Vintage erinnert uns an die gute alte Zeit: Sommerferien bei den Großeltern, die erste Fahrt mit Opas Oldtimer und der beste Apfelkuchen aus Omas Emaille-Form. Erleben Sie eine Zeitreise, schwelgen Sie in Nostalgiegefühlen und schenken Sie sich ein Glas Wein ein. Als Weinbegleitung empfehlen wir ein Reinschnuppern in unsere Vintage-Produktserie.

Est-ce que vous saviez que le mot Vintage voulait originellement dire « vendanges » ? Lorsqu'une pièce de décor est fabriquée à neuf, mais qu'elle est conçue dans le « Used-Look » (look usé), l'on parle de style Vintage. Contrairement, des vraies pièces Vintage, des années 20 jusqu'aux années 80, se trouvent soit sur le marché aux puces, soit au grenier. Qu'elles soient réelles ou imitées, Vintage nous rappelle le bon vieux temps : les vacances d'été chez les grands-parents, la première conduite avec la voiture de collection du grand-père et la meilleure tarte aux pommes du moule en émail de la grand-mère. Découvrez un voyage dans le temps, festoyez dans des sentiments nostalgiques et versez-vous un verre de vin. Nous recommandons, comme accompagnement de vin, un reniflement dans notre série de produit Vintage.



VINOZA
242



KENSAL
242



GARGRAVE
243



BRADFORD
244



BRADFORD 1
245



EDALE
246



TOWNSHEND 2
247



RAMPSIDE
248-250



YOUNGSTOWN
251



WOOTTON
252



KINROSS
253



RODING
254



CHISLE
255



TARLE
256



NIMLET
257



PADSTOW
257



KILBURN
258



STOCKBURY
259



This product is available in different colors and shapes./ Dieser Artikel ist in unterschiedlichen Farben und Formen verfügbar.
Cet article est disponible en différentes couleurs et formes.



43824



43823



43642

43824 VINOZA

table light; ceramic, white / fabric, black
Tischleuchte; Keramik, weiss / Textil, schwarz
luminaire de table; céramique, blanc / tissu, noir

H 535, Ø 300, Base: Ø 120



E27 1x 40W



9 002759 438241

43823 VINOZA

table light; ceramic, black / fabric, white
Tischleuchte; Keramik, schwarz / Textil, weiss
luminaire de table; céramique, noir / tissu, blanc

H 535, Ø 300, Base: Ø 120



E27 1x 40W



9 002759 438234

43642 KENSAL

table light; steel, grey, black / fabric, black
Tischleuchte; Stahl, grau, schwarz / Textil, schwarz
luminaire de table; acier, gris, noir / tissu, noir

H 435, Ø 250, Base: Ø 140



E27 1x 40W



9 002759 436421



43929

43929 GARGRAVE

table light; steel, grey, brushed brass / glass vaporized, black-brown-transparent

Tischleuchte; Stahl, grau, messing-gebürstet / Glas bedampft, schwarz-braun-transparent

luminaire de table; acier, gris, laiton brossé / verre vaporisé, noir-marron-transparent

H 315, Ø 110, Base: Ø 150



E27



1x 40W



9 002759 439293



DESIGN
HIGHLIGHT
DETAIL

DETAIL 43929

The rotary switch can be used to turn the luminaires on and off.

Der Drehschalter kann zum ein- und ausschalten der Leuchten verwendet werden.

Le commutateur rotatif peut être utilisé pour allumer et éteindre les luminaires.





49283



49284



49213

49284 BRADFORD

table light; steel, antique silver / glass, clear
Tischleuchte; Stahl, silber-antik / Glas, klar
luminaire de table; acier, argent antique / verre, transparent

H 330, Ø 140



E27 1x 60W



9 002759 492847



49283 BRADFORD

table light; steel, black / glass, clear
Tischleuchte; Stahl, schwarz / Glas, klar
luminaire de table; acier, noir / verre, transparent

H 330, Ø 140



E27 1x 60W



9 002759 492830



49213 BRADFORD

pendant light; steel, black / glass, clear
Hängeleuchte; Stahl, schwarz / Glas, klar
luminaire en suspension; acier, noir / verre, transparent

H 1100, Ø 140



E27 1x 60W



9 002759 492137





43623

43623 BRADFORD 1

table light; steel, black / glass, clear
Tischleuchte; Stahl, schwarz / Glas, klar
luminaire de table; acier, noir / verre, transparent

L 165, B 150, H 370



E27



1x 60W



9 002759 436230



DESIGN
HIGHLIGHT
DETAIL





43783



43782



43781



43783 EDALE

wall light; steel, wood, black, brown / fabric, cappuccino
Wandleuchte; Stahl, Holz, schwarz, braun / Textil, cappuccino
Applique; acier, bois, noir, marron / tissu, cappuccino

L 150, H 215, A 195



E27



1x 40W



9 002759 437831



L 150

H 215

A 195

43782 EDALE

pendant light; steel, wood, black, brown / fabric, cappuccino
Hängeleuchte; Stahl, Holz, schwarz, braun / Textil, cappuccino
luminaire en suspension; acier, bois, noir, marron / tissu, cappuccino

L 1080, B 510, H 1100



E27



6x 40W



9 002759 437824

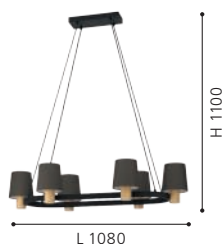

H 1100

L 1080

43781 EDALE

pendant light; steel, wood, black, brown / fabric, cappuccino
Hängeleuchte; Stahl, Holz, schwarz, braun / Textil, cappuccino
luminaire en suspension; acier, bois, noir, marron / tissu, cappuccino

H 1100, Ø 700



E27



6x 40W



9 002759 437817

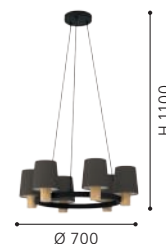

H 1100

Ø 700



49927

49927 TOWNSHEND 2

pendant light; steel, wood, white-patina / fabric, linen, white, brown

Hängeleuchte; Stahl, Holz, weiss-patina / Textil, Leinen, weiss, braun

luminaire en suspension; acier, bois, blanc patiné / tissu, lin, blanc, marron

L 1000, B 150, H 1100



E27



4x 60W



9 002759 499273

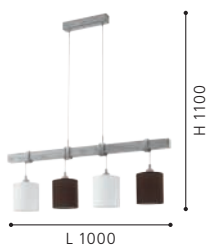



43192



43195

DETAIL 43195

The luminaire heads can be installed on the ceiling individually.
Die Leuchtenköpfe können individuell an die Decke montiert werden.
Les têtes de luminaires peuvent être montées individuellement au plafond.

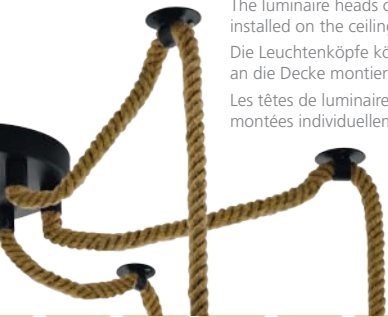

43192 RAMPSIDE

pendant light; steel, black / glass vaporized, amber
Hängeleuchte; Stahl, schwarz / Glas bedampft, amber
luminaire en suspension; acier, noir / verre vaporisé, ambre

L 895, B 195, H 1230



E27 3x 28W



9 002759 431921



43195 RAMPSIDE

pendant light; steel, black
Hängeleuchte; Stahl, schwarz
luminaire en suspension; acier, noir

H 1590, Ø 180



E27 6x 28W



9 002759 431952

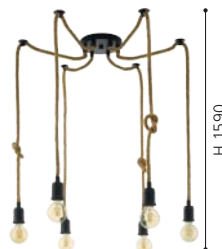

43194 RAMPSIDE

pendant light; steel, black
Hängeleuchte; Stahl, schwarz
luminaire en suspension; acier, noir

H 1090, Ø 760



E27 6x 28W



9 002759 431945

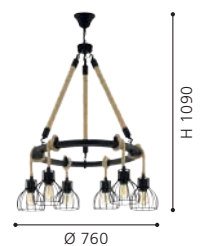



43194



43256



43197

43256 RAMPSIDE

pendant light; steel, black
Hängeleuchte; Stahl, schwarz
luminaire en suspension; acier, noir

H 1380, Ø 110



E27



1x 28W



9 002759 432560



H 1380

Ø 110

43197 RAMPSIDE

wall light; steel, wood, black, brown
Wandleuchte; Stahl, Holz, schwarz, braun
Applique; acier, bois, noir, marron

L 80, H 300, A 135



E27



1x 28W



9 002759 431976



L 80

H 300

A 135



43318



43319

43318 YOUNGSTOWN

pendant light; steel, wood, black, brown
 Hängeleuchte; Stahl, Holz, schwarz, braun
 luminaire en suspension; acier, bois, noir, marron

L 700, B 45, H 1100



E27



4x 40W



9 002759 433185



43319 YOUNGSTOWN

pendant light; steel, wood, black, brown
 Hängeleuchte; Stahl, Holz, schwarz, braun
 luminaire en suspension; acier, bois, noir, marron

L 1000, B 45, H 1100



E27



6x 40W



9 002759 433192

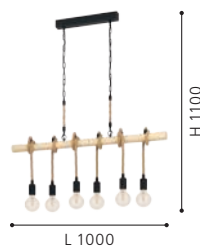

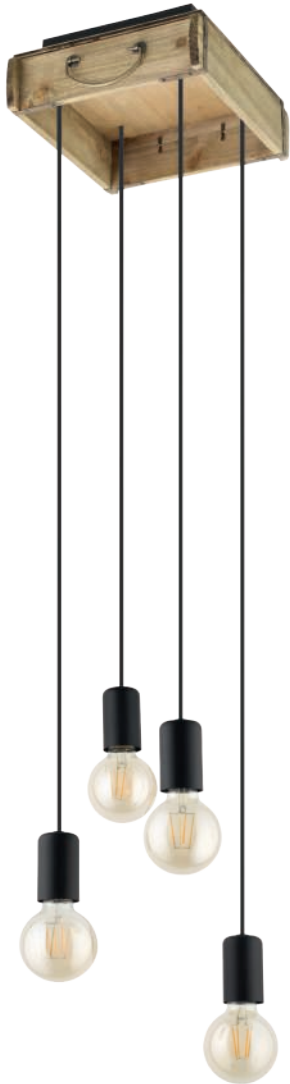

43591



43592



43594

43591 WOOTTON

pendant light; wood, steel, brown, black
 Hängeleuchte; Holz, Stahl, braun, schwarz
 luminaire en suspension; bois, acier, marron, noir

L 250, B 280, H 1100



E27 4x 40W



9 002759 435912



43592 WOOTTON

pendant light; wood, steel, brown, black
 Hängeleuchte; Holz, Stahl, braun, schwarz
 luminaire en suspension; bois, acier, marron, noir

L 810, B 220, H 1100

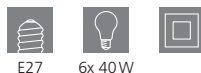

E27 6x 40W



9 002759 435929



43594 WOOTTON

table light; wood, steel, brown, black
 Tischleuchte; Holz, Stahl, braun, schwarz
 luminaire de table; bois, acier, marron, noir

L 250, B 220, H 375



E27 3x 40W



9 002759 435943





49724

49724 KINROSS

pendant light; steel, brown / wood, brown
Hängeleuchte; Stahl, braun / Holz, braun
luminaire en suspension; acier, marron / bois, marron

H 1100, Ø 310



E27



1x 60W



9 002759 497248



H 1100

Ø 310





43619



43618

43619 RODING

wall light; steel, wood, black, brown / glass, clear
Wandleuchte; Stahl, Holz, schwarz, braun / Glas, klar
Applique; acier, bois, noir, marron / verre, transparent

L 180, H 350, A 180



E27



1x 40W



9 002759 436193



43618 RODING

pendant light; steel, wood, black, brown / glass, clear
Hängeleuchte; Stahl, Holz, schwarz, braun / Glas, klar
luminaire en suspension; acier, bois, noir, marron / verre, transparent

L 880, B 180, H 1100



E27



3x 40W



9 002759 436186





43527



43499



43528



DETAIL CHISLE

The mixture of steel and vaporized glass gives these luminaires a unique look.

Die Mischung aus Stahl und bedampftem Glas verleiht diesen Leuchten eine besondere Optik.

Le mélange d'acier et de verre vaporisé donne à ces luminaires un look unique.

43527 CHISLE

pendant light; steel, black, bronzed / glass vaporized, amber

Hängeleuchte; Stahl, schwarz, brüniert / Glas bedampft, amber

luminaire en suspension; acier, noir, brun / verre vaporisé, ambre

H 1100, Ø 165



E27



1x 40W



9 002759 435271

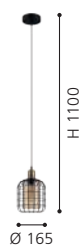

43499 CHISLE

pendant light; steel, black, bronzed / glass vaporized, amber

Hängeleuchte; Stahl, schwarz, brüniert / Glas bedampft, amber

luminaire en suspension; acier, noir, brun / verre vaporisé, ambre

H 1300, Ø 425



E27



3x 40W



9 002759 434991



43528 CHISLE

pendant light; steel, black, bronzed / glass vaporized, amber

Hängeleuchte; Stahl, schwarz, brüniert / Glas bedampft, amber

luminaire en suspension; acier, noir, brun / verre vaporisé, ambre

L 1300, B 165, H 1100



E27



4x 40W



9 002759 435288

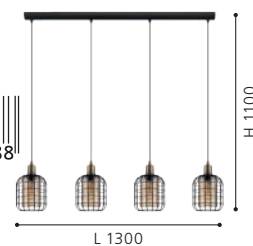



43845

43845 TARLE

pendant light; steel, black
Hängeleuchte; Stahl, schwarz
luminaire en suspension; acier, noir

H 1100, Ø 445



E14



3x 40W



9 002759 438456

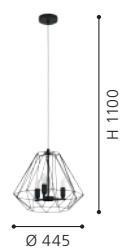



44088



43653

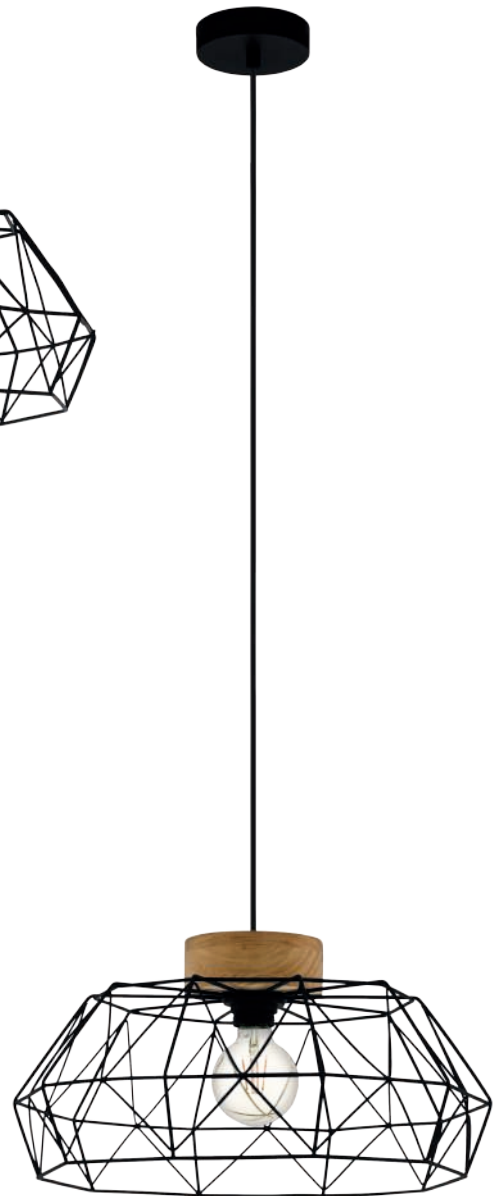

44089



43653 NIMLET

table light; steel, black / fabric, black
Tischleuchte; Stahl, schwarz / Textil, schwarz
luminaire de table; acier, noir / tissu, noir

H 515, Ø 300, Base: Ø 135



E27 1x 40W



9 002759 436537



44088 PADSTOW

ceiling light; steel, wood, black, natural
Deckenleuchte; Stahl, Holz, schwarz, natur
plafonnier; acier, bois, noir, naturel

H 205, Ø 455



E27 1x 60W



9 002759 440886



44089 PADSTOW

pendant light; steel, wood, black, natural
Hängeleuchte; Stahl, Holz, schwarz, natur
luminaire en suspension; acier, bois, noir, naturel

H 1100, Ø 455



E27 1x 60W



9 002759 440893

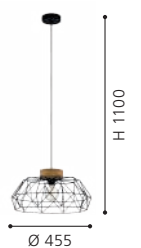



43922



43921



43923



43921 KILBURN

spot; wood, brown / steel, white, brown
Spot; Holz, braun / Stahl, weiss, braun
spot; bois, marron / acier, blanc, marron

L 120, H 185, A 160



E27



1x 40W



9 002759 439217



43922 KILBURN

spot; wood, brown / steel, white, brown
Spot; Holz, braun / Stahl, weiss, braun
spot; bois, marron / acier, blanc, marron

L 360, H 170, A 160



E27



2x 40W



9 002759 439224



43923 KILBURN

spot; wood, brown / steel, white, brown
Spot; Holz, braun / Stahl, weiss, braun
spot; bois, marron / acier, blanc, marron

L 590, H 170, A 160



E27



3x 40W



9 002759 439231





49456

49456 STOCKBURY

pendant light; steel, antique brown, beige
Hängeleuchte; Stahl, antik-braun, beige
luminaire en suspension; acier, marron antique, beige

H 1100, Ø 360



E27



1x 60W



9 002759 494568

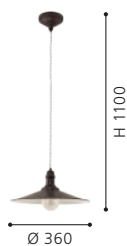

DESIGN
HIGHLIGHT
DETAIL



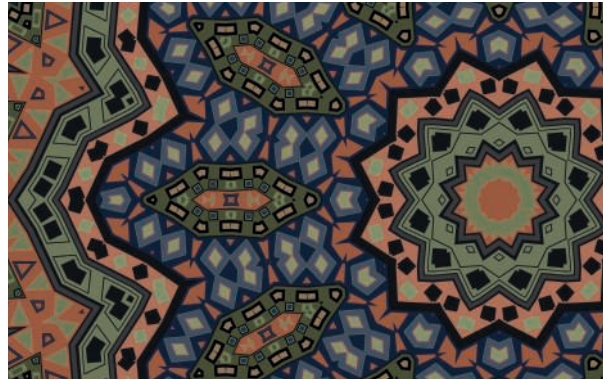

ETHNO ELEGANCE

#EXOTIC
#ORIENT

A little Orient, a bit of Africa, a touch of Latin America – but nothing common at all! These lamps let you dive into a world of exotic markets with spices, colours and shapes. Bring fairy-tale moments from remote countries to your home – with Ethno Elegance.

Ein bisschen Orient, ein wenig Afrika, ein Hauch Lateinamerika – nur nichts Gewöhnliches! Mit diesen Leuchten tauchen Sie ein in eine Welt exotischer Märkte mit Gewürzen, Farben und Formen. Holen Sie märchenhafte Momente aus fernen Ländern zu sich nach Hause – mit Ethno Elegance.

Un peu oriental, un peu africain, une touche d'Amérique latine – surtout rien d'ordinaire ! Grâce à ces luminaires, vous entrez dans un monde de marchés exotiques avec des épices, des couleurs et des formes. Apportez des moments féeriques dans votre maison, venant de pays lointains – grâce à Ethno Elegance.



GRIZEDALE
262



FELIXKIRK
262



MUMBLES
265

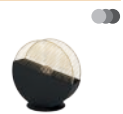

SANDBACH
266



JADIDA
268



TALBOT 2
268



STAVERTON
269



BRIDEKIRK
269



This product is available in different colors and shapes./ Dieser Artikel ist in unterschiedlichen Farben und Formen verfügbar.
Cet article est disponible en différentes couleurs et formes.

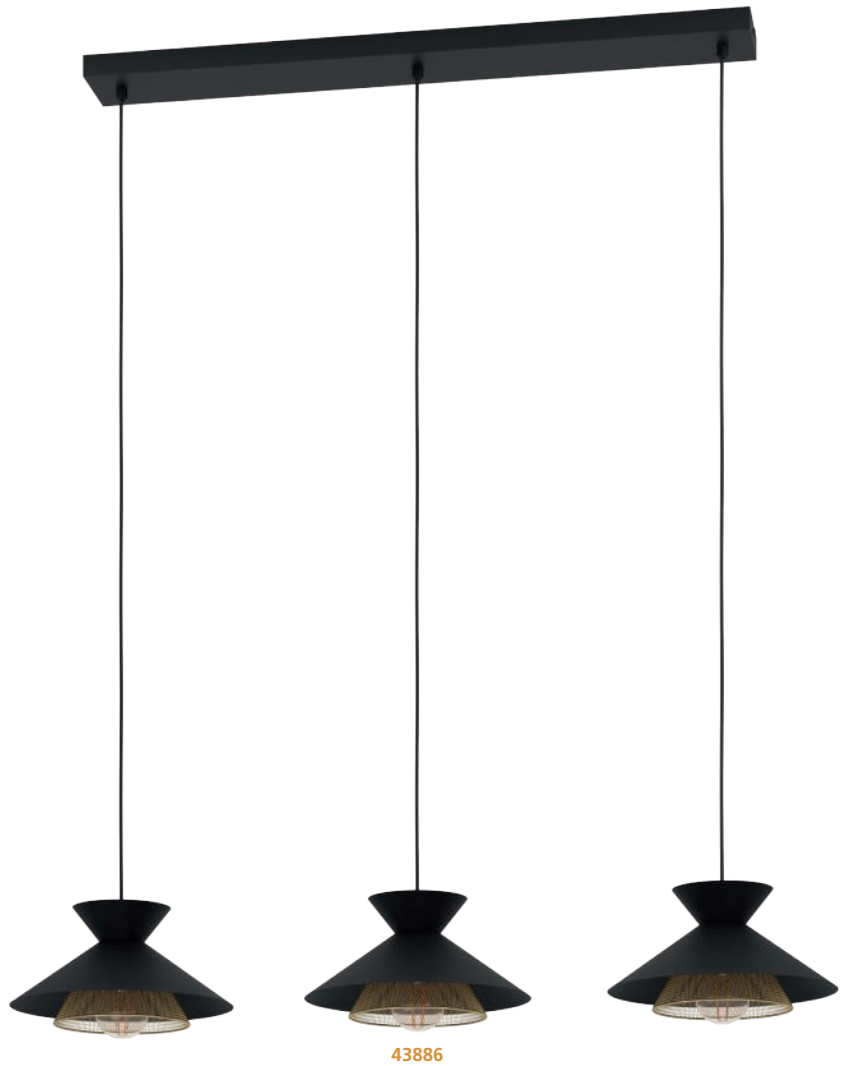
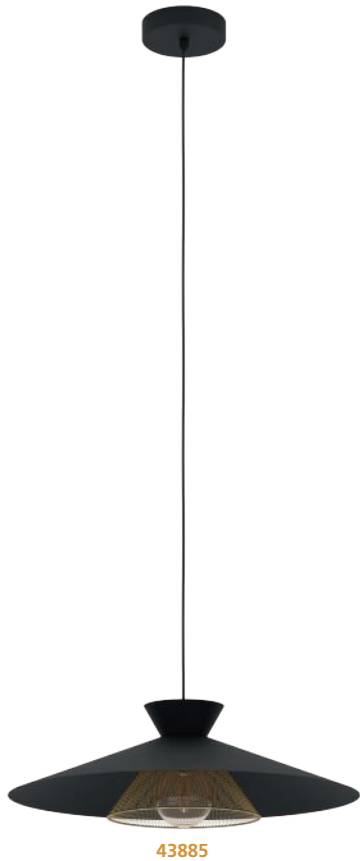

43885 GRIZEDALE

pendant light; steel, black, brass
 Hängeleuchte; Stahl, schwarz, messing
 luminaire en suspension; acier, noir, laiton

H 1100, Ø 500



E27 1x 40W



9 002759 438852

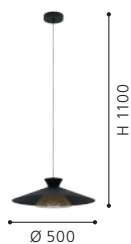

43886 GRIZEDALE

pendant light; steel, black, brass
 Hängeleuchte; Stahl, schwarz, messing
 luminaire en suspension; acier, noir, laiton

L 960, B 260, H 1100



E27 3x 40W



9 002759 438869

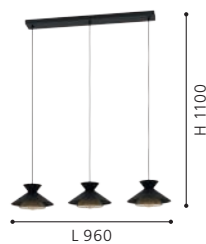

43931 FELIXKIRK

pendant light; steel, black / steel, black, gold
 Hängeleuchte; Stahl, schwarz / Stahl, schwarz, gold
 luminaire en suspension; acier, noir / acier, noir, or

H 1100, Ø 570



E27 1x 40W



9 002759 439316





43931





43813

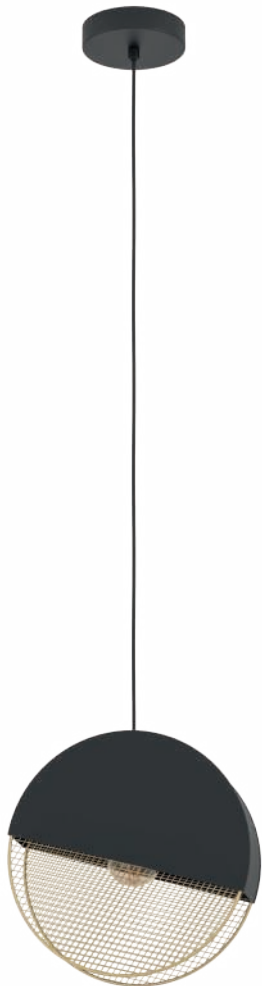

43811



43812

43813 MUMBLES

table light; steel, black, gold
Tischleuchte; Stahl, schwarz, gold
luminaire de table; acier, noir, or

L 280, B 90, H 285, Base: Ø 170



E27 1x 40W



9 002759 438135

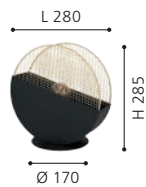

43811 MUMBLES

pendant light; steel, black, gold
Hängeleuchte; Stahl, schwarz, gold
luminaire en suspension; acier, noir, or

L 285, B 90, H 1100



E27 1x 40W



9 002759 438111

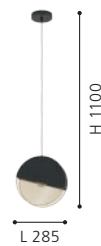

43812 MUMBLES

pendant light; steel, black, gold
Hängeleuchte; Stahl, schwarz, gold
luminaire en suspension; acier, noir, or

L 860, B 90, H 1100



E27 2x 40W



9 002759 438128

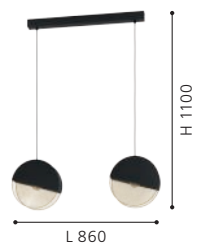



43979



43982

43979 SANDBACH

ceiling light; steel, black, brass
Deckenleuchte; Stahl, schwarz, messing
plafonnier; acier, noir, laiton

H 220, Ø 420



E27 1x 40W



9 002759 439798

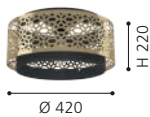

43982 SANDBACH

table light; steel, black, brass
Tischleuchte; Stahl, schwarz, messing
luminaire de table; acier, noir, laiton

H 450, Ø 240, Base: Ø 200



E27 1x 40W



9 002759 439828

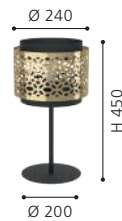

43981 SANDBACH

pendant light; steel, black, brass
Hängeleuchte; Stahl, schwarz, messing
luminaire en suspension; acier, noir, laiton

H 1100, Ø 420



E27 1x 40W



9 002759 439811





43981





49764



49717



DESIGN
HIGHLIGHT
DETAIL

49764 JADIDA

pendant light; steel, antique copper coloured / glass, coloured
Hängeleuchte; Stahl, kupferfarben-antik / Glas, bunt
luminaire en suspension; acier, cuivré antique / verre, coloré

H 1100, Ø 330



E27



1x 60W



9 002759 497644



49717 TALBOT 2

pendant light; steel, antique white
Hängeleuchte; Stahl, weiss-antik
luminaire en suspension; acier, blanc antique

H 1100, Ø 295



E27



1x 60W



9 002759 497170



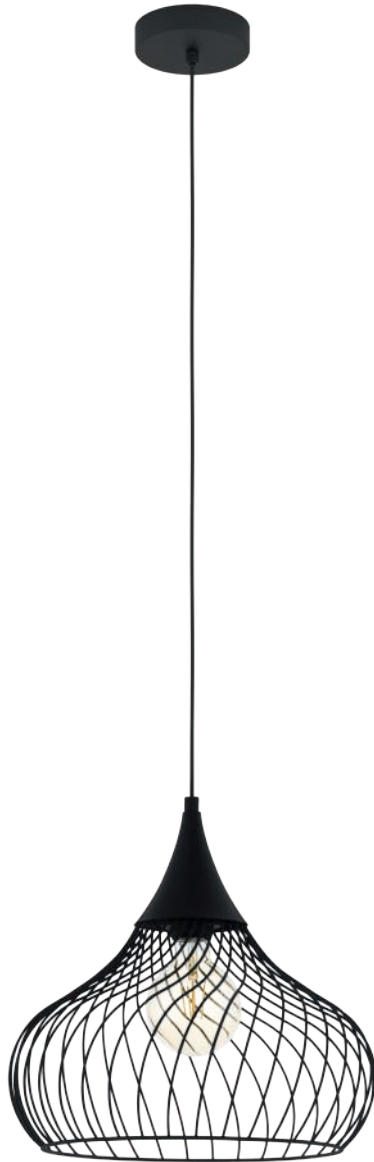

43344

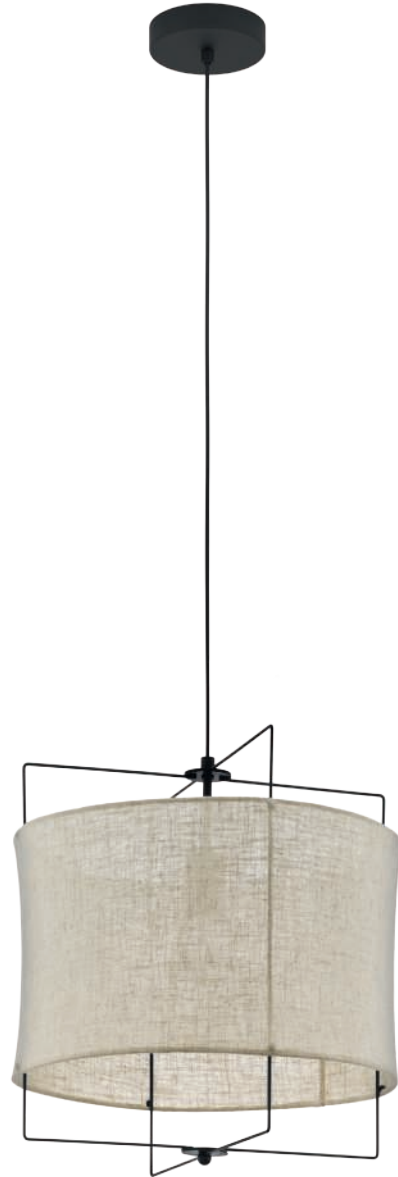

43292

43344 STAVERTON

pendant light; steel, black
 Hängeleuchte; Stahl, schwarz
 luminaire en suspension; acier, noir

H 1100, Ø 365



E27



1x 60W



9 002759 433444



43292 BRIDEKIRK

pendant light; steel, black / fabric, linen, natural
 Hängeleuchte; Stahl, schwarz / Textil, Leinen, natur
 luminaire en suspension; acier, noir / tissu, lin, nature

H 1100, Ø 400



E27



1x 40W



9 002759 432928





SOCKETS & ILLUMINANTS

#BRIGHT
#LIGHT

Minimalism at its best! The SOCKET series by EGLO comes in a variety of styles: from a discreet brass ring attachment to a gritty industrial finish. The most important thing is to choose the best light source to skilfully present the luminaire in its best light.

Minimalismus pur! So präsentiert sich die SOCKET-Serie von EGLO in verschiedenen Stilen: Ob mit dezentem Messingring oder grober Industrial-Haptik. Wichtig bleibt dabei die Wahl des richtigen Leuchtmittels, um die Fassung gekonnt in Szene zu setzen.

Le minimalisme à l'état pur ! Voici comment se présente la série SOCKET d'EGLO dans différents styles : avec un discret anneau en laiton ou une structure rugueuse à l'esprit industriel. L'essentiel est de bien choisir l'ampoule afin de mettre habilement la douille en valeur.



CRANLEY 272	CRANLEY 1 272	YORTH 273-274	CALARI 274	110051 277	110052 277	110053 277	110058 278
110055 278	110057 278	110079 281	110083 281	110091 281	110094 282	110085 282	110088 282
110029 283	110031 283	12552 286	12553 286	12554 287	12588 287	110268 289	110267 289
110233 291	110234 291	110109 292	110111 292	110112 293			



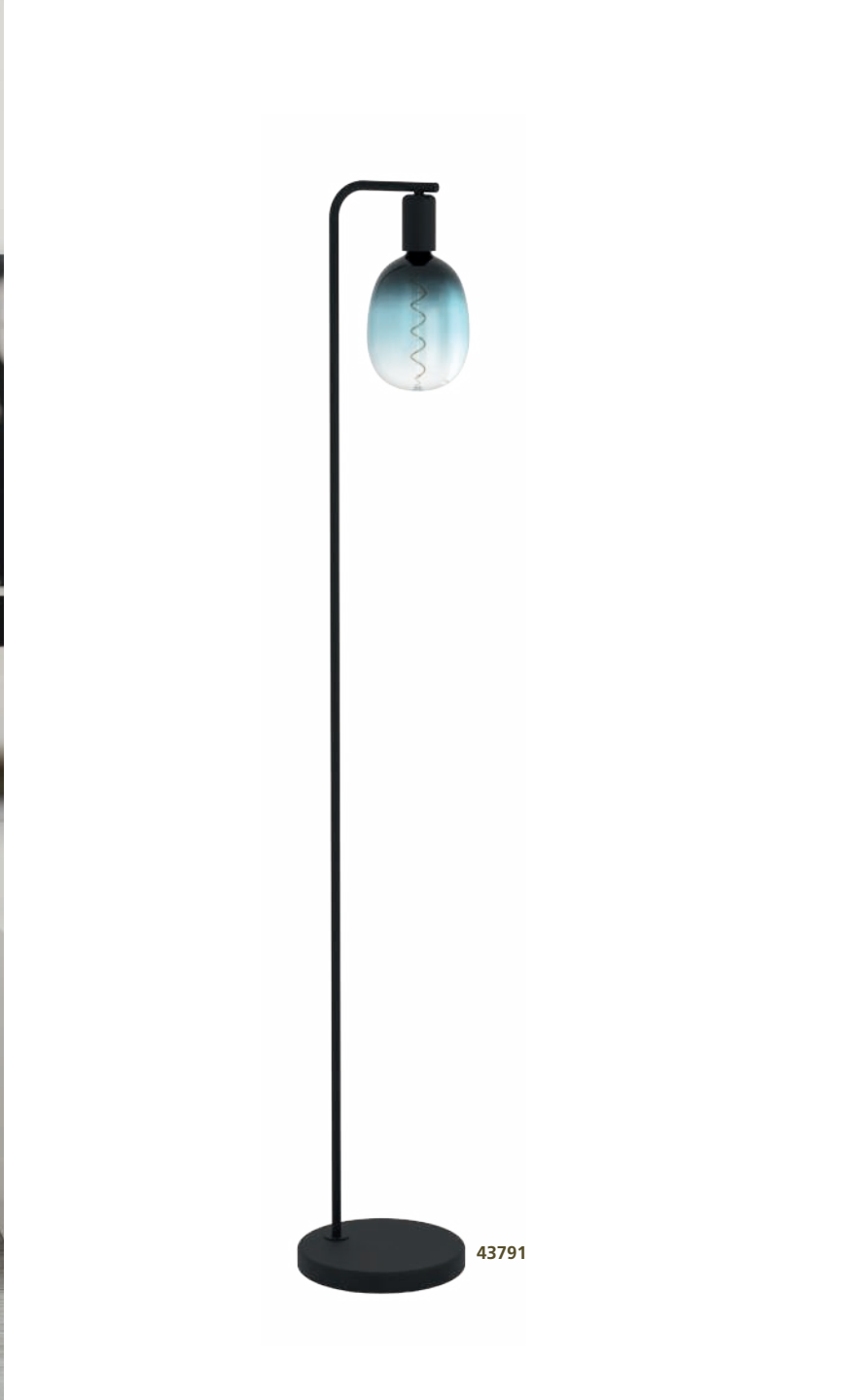

43758 CRANLEY

floor light; steel, black
 Stehleuchte; Stahl, schwarz
 lampadaire; acier, noir

L 430, B 60, H 1700, Base: Ø 300



E27



1x 40W



9 002759 437589

43791 CRANLEY 1

floor light; steel, black
 Stehleuchte; Stahl, schwarz
 lampadaire; acier, noir

H 1485, Base: Ø 230



E27



1x 40W



9 002759 437916



43803



43802

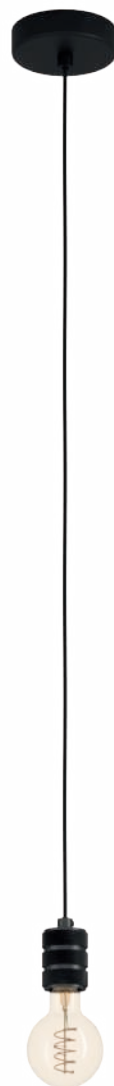

43801



DESIGN
HIGHLIGHT
DETAIL

43803 YORTH

pendant light; steel, black, bronzed
Hängeleuchte; Stahl, schwarz, brüniert
luminaire en suspension; acier, noir, brun

H 1500, Ø 50



E27 1x 40W



9 002759 438036



43802 YORTH

pendant light; steel, black, silver
Hängeleuchte; Stahl, schwarz, silber
luminaire en suspension; acier, noir, argent

H 1500, Ø 50



E27 1x 40W



9 002759 438029



43801 YORTH

pendant light; steel, nickel-nero, black
Hängeleuchte; Stahl, nickel-nero, schwarz
luminaire en suspension; acier, nickel brillant, noir

H 1500, Ø 50



E27 1x 40W



9 002759 438012





32539



31075

32539 YORTH

pendant light; steel, brushed copper
 Hängeleuchte; Stahl, kupfer-gebürstet
 luminaire en suspension; acier, cuivre brossé

H 2000, Ø 100



E27 1x 60W



9 002759 325398

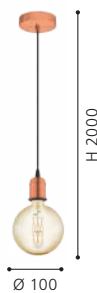

31075 CALARI

pendant light; steel, black, brass
 Hängeleuchte; Stahl, schwarz, messing
 luminaire en suspension; acier, noir, laiton

H 1500, Ø 45



E27 1x 40W



9 002759 310752



31073 CALARI

pendant light; steel, black
 Hängeleuchte; Stahl, schwarz
 luminaire en suspension; acier, noir

L 95, B 65, H 1500



E27 1x 40W



9 002759 310738





31073

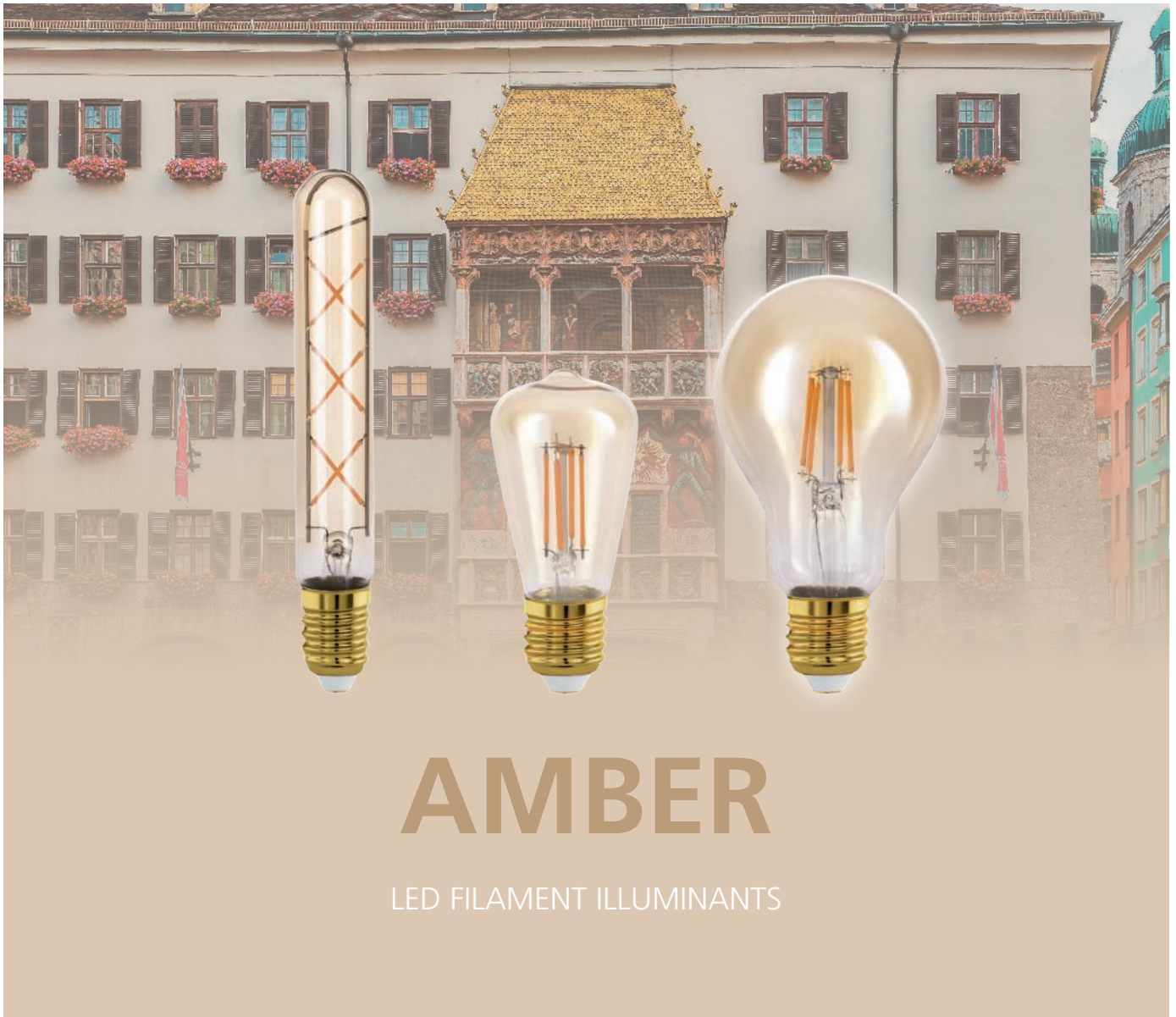

AMBER

LED FILAMENT ILLUMINANTS

AMBER

LED FILAMENT ILLUMINANTS

- › Perfect look for retro luminaires
- › Pleasant ambience
- › Sufficient all-round lighting
- › Low energy costs at only 4W energy consumption

AMBER

LED FILAMENT LEUCHTMITTEL

- › Perfekter Look bei Retro-Leuchten
- › Angenehmes Ambiente
- › Ausreichende Rundumbeleuchtung
- › Niedrige Energiekosten bei nur 4W Stromverbrauch

AMBER

AMPOULES DEL À FILÀMENT

- › Un aspect parfait pour les luminaires rétro
- › Atmosphère agréable
- › éclairage suffisant tout autour
- › Faibles coûts énergétiques avec une consommation de seulement 4W



110051 E27-LED-A75



L 130, Ø 75	not dimmable	80 CRI
4 W	15000 h	
220-240V, 50/60Hz	8	
E27	4 W ~ 32 W	9 008606 227853



110052 E27-LED-G80



L 120, Ø 80	not dimmable	80 CRI
4 W	15000 h	
220-240V, 50/60Hz	4	
E27	4 W ~ 32 W	9 008606 227860



110053 E27-LED-G95



L 140, Ø 95	not dimmable	80 CRI
4 W	15000 h	
220-240V, 50/60Hz	4	
E27	4 W ~ 31 W	9 008606 227877



110058 E14-LED-C35

270 lm
warm
WHITE
2200 K

L 98, Ø 35	not dimmable	80 CRI
4 W	15000 h	
220-240V, 50/60Hz	8	
E14	4 W ~ 26 W	9 008606 227921



110055 E27-LED-ST64

270 lm
warm
WHITE
2200 K

L 142, Ø 64	not dimmable	80 CRI
4 W	15000 h	
220-240V, 50/60Hz	8	
E27	4 W ~ 26 W	9 008606 227891



110057 E27-LED-T30

350 lm
warm
WHITE
2200 K

L 185, Ø 30	not dimmable	80 CRI
4 W	15000 h	
220-240V, 50/60Hz	8	
E27	4 W ~ 32 W	9 008606 227914





DECORATIVE SPIRAL

LED FILAMENT ILLUMINANTS

DECORATIVE SPIRAL

LED FILAMENT ILLUMINANTS

- › Extraordinary LED shape
- › Sufficient all-round lighting
- › Low energy consumption with only 4 watt power
- › Sets your luminaire perfectly in scene

DECORATIVE SPIRAL

LED FILAMENT LEUCHTMITTEL

- › Außergewöhnliche Form der LED
- › Ausreichende Rundumbeleuchtung
- › Niedrige Energiekosten bei nur 4 Watt Leistung
- › Setzt Ihre Leuchte perfekt in Szene

DECORATIVE SPIRAL

AMPOULES DEL À FILÀMENT

- › Forme de la DEL hors du commun
- › Éclairage rond suffisant
- › Faible coût énergétique avec seulement 4 watts de puissance
- › Met votre luminaire parfaitement en scène

110079 E27-LED-G80



245 lm	warm WHITE	2000 K	
L 120, Ø 80	dimmable	80 CRI	
4 W	15000 h		
220-240V, 50/60Hz	4		
E27	4 W ~ 25 W		



110083 E27-LED-ST64



245 lm	warm WHITE	2000 K	
L 142, Ø 64	dimmable	80 CRI	
4 W	15000 h		
220-240V, 50/60Hz	8		
E27	4 W ~ 25 W		



110091 E27-LED-G80



30 lm	warm WHITE	2000 K	
L 120, Ø 80	dimmable	66 CRI	
4 W	15000 h		
220-240V, 50/60Hz	4		
E27	4 W ~ 3 W		





110094 E27-LED-ST64



L 142, Ø 64	dimmable	66 CRI
4 W	15000 h	
220-240V, 50/60Hz	8	
E27	4 W ~ 3 W	9 008606 228249



110085 E27-LED-G80



L 120, Ø 80	dimmable	82 CRI
4 W	15000 h	
220-240V, 50/60Hz	4	
E27	4 W ~ 11 W	9 008606 228164



110088 E27-LED-ST64



L 142, Ø 64	dimmable	82 CRI
4 W	15000 h	
220-240V, 50/60Hz	8	
E27	4 W ~ 11 W	9 008606 228195

110029 E27-LED-A60



806 lm



2700 K



L 106, Ø 60



not dimmable



80 CRI



7.3 W



25000 h



220-240V, 50/60Hz



8



E27



7.3 W ~ 60 W



110031 E27-LED-A60



806 lm



2700 K



L 106, Ø 60



not dimmable



80 CRI



7.3 W



25000 h



220-240V, 50/60Hz



8



E27



7.3 W ~ 60 W



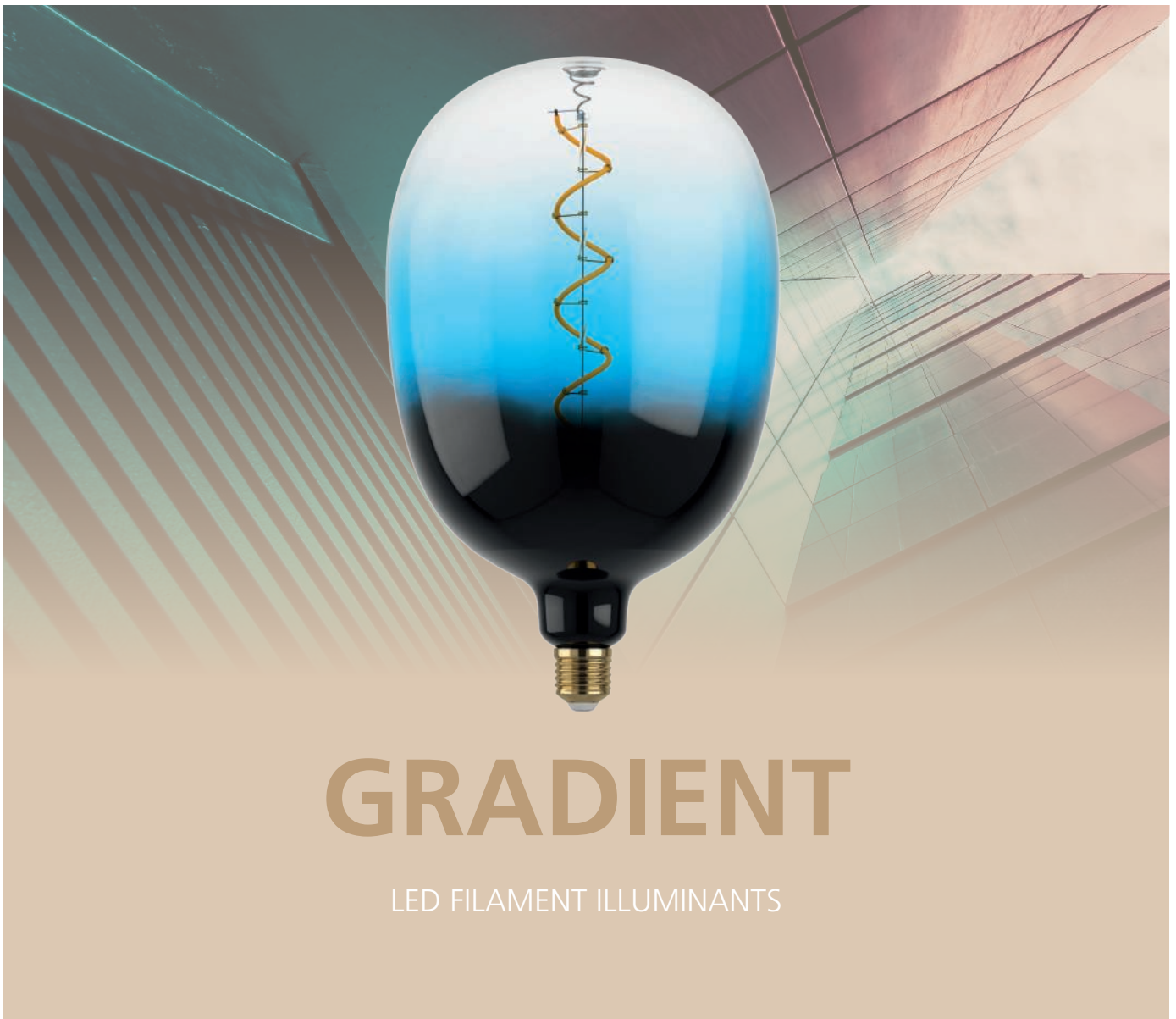

GRADIENT

LED FILAMENT ILLUMINANTS

GRADIENT

LED FILAMENT ILLUMINANTS

- › Sophisticated, novel Shapes
- › Aesthetic variety
- › Perfectly combinable
- › Dimmable
- › Available in 4 colors

GRADIENT

LED FILAMENT LEUCHTMITTEL

- › Raffinierte, neuartige Formen
- › Ästhetischer Farbverlauf
- › Perfekt kombinierbar
- › Dimmbar
- › Verfügbar in 4 Farben

GRADIENT

AMPOULES DEL À FILÀMENT

- › Formes sophistiquées et nouvelles
- › Variété esthétique
- › Parfaitement combinable
- › Gradable
- › Disponible en 4 couleurs



BEST CHOICE

This button marks discontinued items that are sold at the best price.

Dieser Button markiert Auslaufartikel, die zum Bestpreis abgegeben werden.

Ce bouton met en évidence les articles de fin de série qui sont cédés au meilleur prix.



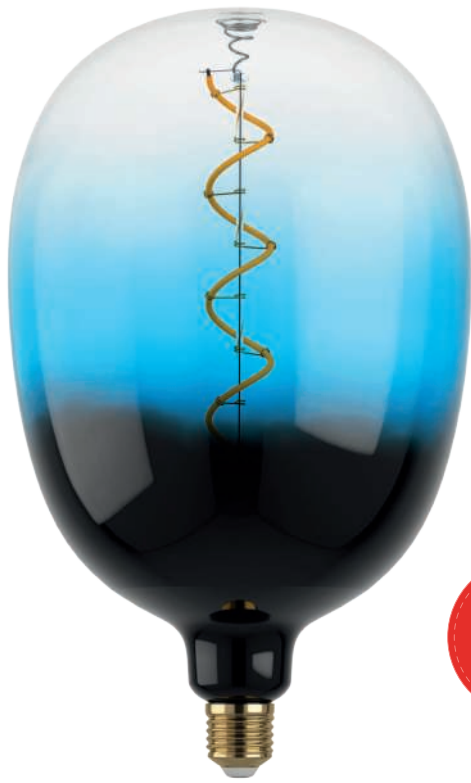

12552 E27-LED-T180

85 lm	warm WHITE	2000 K	
L 295, Ø 180	4 W ~ 10 W		
4 W	80 CRI		
220-240V, 50/60Hz			
E27			
dimmable			
25000 h	9 002759 125523		













12553 E27-LED-T180

100 lm	warm WHITE	1700 K	
L 295, Ø 180	4 W ~ 11 W		
4 W	80 CRI		
220-240V, 50/60Hz			
E27			
dimmable			
25000 h	9 002759 125530		













12554 E27-LED-T180

 85 lm	warm WHITE	1800 K	
 L 295, Ø 180	 4 W ~ 10 W		
 4 W	 80 CRI		
 220-240V, 50/60Hz			
 E27			
 dimmable			
 25000 h	 9 002759 125547		



12588 E27-LED-T180

 85 lm	warm WHITE	1800 K	
 L 295, Ø 180	 4 W ~ 10 W		
 4 W	 80 CRI		
 220-240V, 50/60Hz			
 E27			
 dimmable			
 25000 h	 9 002759 125882		



NEW DECORATIVE

LED FILAMENT ILLUMINANTS

NEW DECORATIVE

LED FILAMENT ILLUMINANTS

- › Elegantly arranged LED filaments
- › Modern designs for sophisticated decorative lighting
- › Low energy costs with 4 Watt output
- › New coatings provide first class colours

NEU DECORATIVE

LED FILAMENT LEUCHTMITTEL

- › Elegant angeordnete LED Filaments
- › Moderne Designs für anspruchsvolle Dekorativbeleuchtung
- › Niedrige Energiekosten bei 4 Watt Leistung
- › Neue Beschichtungen sorgen für erstklassige Farben

NOUVEAU DÉCORATIF

AMPOULES DEL À FILÀMENT

- › Filaments LED élégamment disposés
- › Designs modernes pour un éclairage décoratif sophistiqué Faibles coûts
- › Énergétiques pour une puissance de 4 watts
- › De nouveaux revêtements assurent des couleurs de première qualité



110268 E27-LED-G125

NEW



40 lm

warm
WHITE

2000 K



L 180, Ø 125



4 W ~ 6 W



4 W



80 CRI



220-240V, 50/60Hz



E27



dimnable



25000 h



9 008606 267200



110267 E27-LED-G190

NEW



40 lm

warm
WHITE

2000 K



L 255, Ø 190



4 W ~ 6 W



4 W



80 CRI



220-240V, 50/60Hz



E27



dimnable



25000 h



9 008606 267194



BIG SIZE

LED FILAMENT ILLUMINANTS

- › Extra-large shape
- › An eye-catcher in your living area
- › Your illuminant becomes a luminaire
- › Dimmable

BIG SIZE

LED FILAMENT LEUCHTMITTEL

- › Extra große Form
- › Der Blickfang in Ihrem Wohnbereich
- › Ihr Leuchtmittel wird zur Leuchte
- › Dimmbar









BIG SIZE

AMPOULES DEL À FILÀMENT

- › Forme extra grande
- › L'attrape œil dans votre espace d'habitat
- › Votre illuminant devient un luminaire
- › réglable













110233 E27-LED-D165

 220 lm	warm WHITE	1800 K	
 H 280, Ø 165	 4 W ~ 22 W		
 4 W	 90 CRI		
 220-240V, 50/60Hz			
 E27			
 dimmable			
 15000 h			 9 008606 242900



110234 E27-LED-D165

 70 lm	warm WHITE	1800 K	
 H 280, Ø 165	 4 W ~ 9 W		
 4 W	 90 CRI		
 220-240V, 50/60Hz			
 E27			
 dimmable			
 15000 h			 9 008606 242917

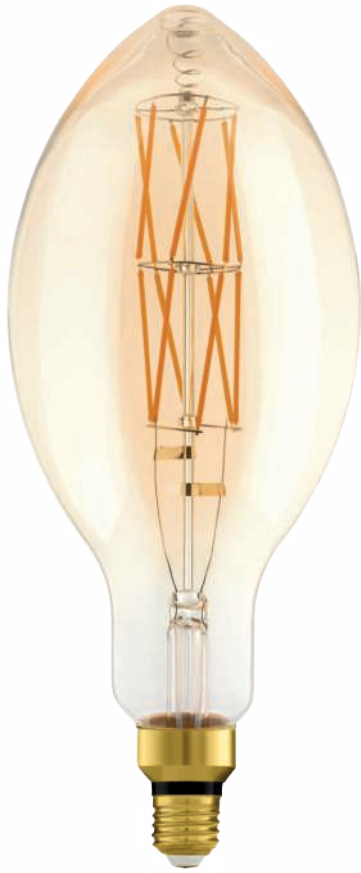



110109 E27-LED-E140

 **806 lm** warm
WHITE **2100 K** 

 L 340, Ø 140

 8 W ~ 60 W

 8 W

 80 CRI

 220-240V, 50/60Hz

 E27

 dimmable

 15000 h

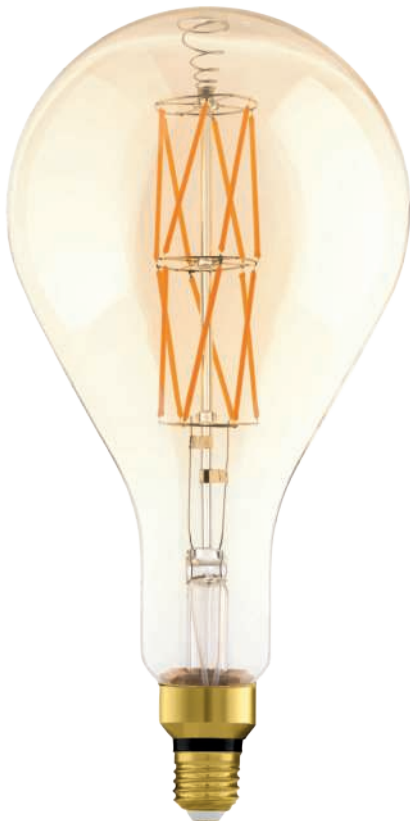



110111 E27-LED-PS160

 **806 lm** warm
WHITE **2100 K** 

 L 320, Ø 160

 8 W ~ 60 W

 8 W

 80 CRI

 220-240V, 50/60Hz

 E27

 dimmable

 15000 h







110112 E27-LED-G200

 **806 lm**  **warm WHITE** **2100 K**  **A++ G F**

 L 305, Ø 200

 8 W ~ 60 W

 8 W

 80 CRI

 220-240V, 50/60Hz

 E27

 dimmable

 15000 h



EGLO WORLDWIDE – SALES COMPANIES

EGLO WELTWEIT – VERTRIEBSGESELLSCHAFTEN

EGLO WOLRDWIDE – SOCIÉTÉS DE VENTE



AUSTRIA

EGLO LEUCHTEN GMBH

Heiligkreuz 22
6136 Pill
T: +43 5242 6996 110 | F: +43 5242 6996 972
info-austria@eglo.com



CHILE

EGLO CHILE ILUMINACIÓN LTDA.

Av. Américo Vespucio Norte 1930
Conchalí - Santiago de Chile
T: +562 2 595 2222
info-chile@eglo.com



DENMARK

EGLO DANMARK A/S

Agerbakken 20
8362 Hørning
T: +45 70 22 55 11
info-denmark@eglo.com



AUSTRALIA

EGLO LIGHTING AUSTRALIA

5/339 Archerfield Road
4077 Richlands | Queensland
T: +61 7 3375 1413 | F: +61 7 3375 1412
info@eglolighting.com.au



CHINA

DONGGUAN EGLO LIGHTING
COMMERCIAL CO LTD

No.1 | Shangqiao Industrial Rd Shangqiao, Dongcheng
Dongguancity, Guanzhouprovince
T: +86 769 2203 3866 | F: +86 769 2203 6866
info-china@eglo.com



ESTONIA

MOODNE VALGUSTUS AS

Rävala pst. 7
10143 Tallinn
T: +372 667 6670 | F: +372 631 3195
info-estonia@eglo.com



BELGIUM

EGLO BELGIUM BV

Antwerpsteenweg 247
2950 Kapellen
T: +32 3 250 60 80 | F: +32 3 219 80 67
info-belgium@eglo.com



COLOMBIA

EGLO COLOMBIA ILUMINACIÓN SAS

Autopista Norte 800 Mts adelante del Peaje de los Andes
Costado Oriental Km 19 Lote 30
Bogotá - Chia
T: +57 (1) 744 2339
info-colombia@eglo.com



FINLAND

EGLO FINLAND OY

Malmi raitti 17A
00700 Helsinki
T: +358 20 7649 820
info-finland@eglo.com



BOSNIA AND HERZEGOVINA

EGLO RASVIJETA BH D.O.O.

Hrgovi Donji 178
76250 Gradacac
T: +387 35 86 85 00 | F: +387 35 82 44 41
info-Bosnia-Herzegovina@eglo.com | info@eglo.ba



COSTA RICA

EGLO COSTA RICA

Centro Comercial Calle Real local #8 de la sucursal del
BAC San José 800 metros al norte Guachipilín de Escazú
San José, Costa Rica
T: +506-2289-4690 | F: +506-2100-6384
info-costarica@eglo.com



FRANCE

EGLO FRANCE LUMINAIRE SARL

Z.A. Jeune Bois | 2 Rue de la Martinique
68274 Wittenheim
T: +33 3 89 62 50 45 | F: +33 389 6250 49
info-france@eglo.com



BULGARIA

EGLO BULGARIA EOOD

Main Road Burgas-Sofia | 5th kilometer | Building EGLO
8000 Burgas
T: +359 888 755 509
info-bulgaria@eglo.com



CROATIA

EGLO RASVIJETA D.O.O.

Jadranska avenija 9
10020 Zagreb
T: +385 1 379 40 62 | F: +385 1 379 41 04
info-croatia@eglo.com



GERMANY

EGLO LEUCHTEN HANDELS GMBH

Kleinbahnstr. 35
59759 Arnsberg
T: +49 2932 6269 0 | F: +49 2932 6269 39
info-germany@eglo.com



CANADA

EGLO CANADA INC.

20700 Route Transcanadienne
H9X 4B7 Baie D'Ufré, Quebec
T: +1 514 457 5483 | F: +1 514 457 5487
info-canada@eglo.com



CZECH REPUBLIC

EGLO CZ+SK s.r.o.

Náhodská 2479/63
193 00 Praha 9
T: +420 281 924 163 | F: +420 281 925 205
info-czechrepublic@eglo.com



GREAT BRITAIN AND IRELAND

EGLO UK LTD.

54 Denington Rd, Denington Industrial Estate
Wellingborough NN8 2QH, UK
T: +44 1604 790 986
info-UK@eglo.com

**GREECE**

EGLO HELLAS A.E.

Sykias 2 and parodos dekeleias
13679 Acharnai
T: +30 21 0800 2363
info-greece@eglo.com

**HUNGARY**

EGLO LUX KFT.

Fő út 143/A
2120 Dunakeszi
T: +36 27 341 353
info-hungary@eglo.com

**INDIA**

EGLO INDIA PRIVATE LIMITED

A-307, Ansal Chambers - 1, 3, Bhikaji Cama Place,
110066 Delhi
T: +91 85279 44288
info-india@eglo.com

**ITALY**

EGLO ITALIANA S.R.L.

Via Giotto, 4
31021 Mogliano Veneto (TV)
T: +39 041 45 66 245 | F: +39 041 45 74 066 / 071
info-italy@eglo.com

**KAZAKHSTAN**

EGLO KAZAKHSTAN LLP

Al-Farabi Avenue 7, Office 72, 14rd floor, Block 4A,
Nurly-Tau Business Center
50059 Almaty
T: +7 727 293 25 20 | M: +7 701 031 00 00
info-kazakhstan@eglo.com

**KOSOVO**

EGLO KOSOVA LLC

Lugisht e qytetit pn
20000 Prizren
T: +383 44 216 687 | SHOP: +383 49 699 100
info-kosovo@eglo.com

**LATVIA**

MOODNE VALGUSTUS AS

Rāvala pst.7
10143 Tallinn
T: +370 652 49923 | T: +372 667 6670
info-latvia@eglo.com

**LITHUANIA**

MOODNE VALGUSTUS AS

Rāvala pst.7
10143 Tallinn
T: +370 652 49923 | T: +372 667 6670
info-lithuania@eglo.com

**MALAYSIA**

EGLO ASIA SDN BHD

B-07-13, Empire Soho, Empire Subang, Jalan SS 16/1,
47500 Subang Jaya, Selangor Darul Ehsan.
T: +60162115313
info-malaysia@eglo.com

**MEXICO**

EGLO MÉXICO ILUMINACIÓN S DE RL DE CV

Prolongación Avenida López Mateos Sur N°3561,
Fraccionamiento Los Gavilanes
C.P. 45645 Tlajomulco de Zúñiga | Jalisco
T: +52 33 3687 20 95
info-mexico@eglo.com

**MIDDLE EAST**

EGLO LIGHTING MIDDLE EAST FZE

P.O. BOX 262073, LOB6, OFFICE G18
Jebel Ali, Dubai, UAE
T: +97 148810080 | F: +97 148810081
gulf@eglo.com

**MOROCCO - EGLO AFRICA**

EGLO MAGHREB LUMINAIRES SARL

219 Bd Med Zerkoutni. Suite: 67
20230 Casablanca
T: +212 522 98 80 25 / -05
info-global@eglo.com | info.africa@eglo.com

**THE NETHERLANDS**

EGLO VERLICHTING NEDERLAND B.V.

Innovatiepark 20
4906 AA Oosterhout (NB)
T: +31 162 48 28 30
info-nl@eglo.com

**NORWAY**

MS BELYSNING

Gardermovegen 95B
2030 Nannestad
T: +47 63 888500 | F: +47 63 888501
info-norway@eglo.com

**PERU**

EGLO PERU S.A.C

Av Primavera 1419
Distrito de Santiago de Surco y Departamento de Lima
T: +51 902 763 635
info-peru@eglo.com

**POLAND**

EGLO POLSKA SP. Z O.O.

Ul. Dżwiękowa 2
02-857 Warszawa
T: +48 22 644 57 55 | T: +48 22 644 89 82
info-poland@eglo.com

**PORTUGAL**

EGLO PORTUGAL ILUMINAÇÃO, LDA

Rua Fonte Parada, 125
4595-434 Seroa-Paços de Ferreira
T: +351 255 890 000
info-portugal@eglo.com

**ROMANIA**

EGLO ROMANIA PRODEXIM SRL.

Str. Atomistilor nr. 1D
77125 Magurele - Ilfov
T: +40 314 250 902 | F: +40 314 250 899
info-romania@eglo.com

**RUSSIA**

EGLO LIGHTING LLC

Varshavskoe shosse 3 | Office 23
117105 Moscow
T: +7495 789 4311 | F: +7495 789 4312
info-russia@eglo.com

**SERBIA**

EGLO RASVETA DOO

Stefana Prvovenčanog 28
11000 Beograd
T: +381 11 3981 366 | F: +381 11 3981 389
info-serbia@eglo.com

**SLOVAKIA**

EGLO CZ+SK s.r.o

Náchodská 2479/63
193 00 Praha 9
T: +421 313 211 551 | F: +421 313 211 556
info-slovakia@eglo.com

**SLOVENIA**

EGLO RASVJETA D.O.O.

Jadranska avenija 9
10020 Zagreb
T: +386 158 093 18
info-slovenia@eglo.com

**SPAIN**

EGLO ESPANA ILUMINACIÓN S.L.

Avda. de Castilla,1 (Edif. Best Point) 2º Planta - Oficina
16A-B
28830 San Fernando de Henares, Madrid
T: +34 91 677 90 44 | F: +34 91 677 03 04
info-spain@eglo.com

**SWEDEN**

EGLO SVERIGE AB

Star Street 1
512 50 Svenljunga
T: +46 340 623 505
info-sweden@eglo.com

**SWITZERLAND**

EGLO SCHWEIZ AG

Seetalstrasse 142
6032 Emmen
T: +41 41 268 69 59
info-switzerland@eglo.com

**TURKEY**

EGLO Aydınlatma ithalat ihracat Ltd. Şti.

Eyüp Sultan Mah. Sekmen Cad. No:18/2
34885 Sancaktepe / Istanbul Samandıra
T: +90 216 311 09 -02 / -03 / -04 |
F: +90 216 311 09 / -05
info-turkey@eglo.com

**UKRAINE**

EGLO UKRAINE LTD

Vatslava Gavela boulevard, 6/7-A,
03124 Kyiv
T: +38 067 670 58 61
info-ukraina@eglo.com

**USA**

EGLO USA, INC.

3640 Royal South Parkway
30349 Atlanta, Georgia
T: +1 404 477 5601 | F: +1 404 393 7053
info-usa@eglo.com

HOW TO READ

ERKLÄRUNG

COMMENT LIRE

PRODUCT / PRODUCT IN THE AMBIANCE
PRODUKT / PRODUKTE IM AMBIENTE
PRODUITS / PRODUITS DANS L'AMBIENCE

You can find the article number next to each product on the page and in the ambiance pictures.

Sie finden die Artikelnummer auf jeder Seite und neben jeder Abbildung des Produktes und auf unseren Ambientebildern.

Vous pouvez trouver le numéro d'article à la page et à côté de chaque produit dans les images de l'ambiance.



Trend & Style 2024/25 - Loft

172

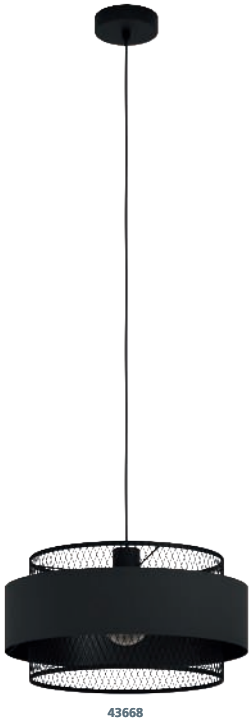

43668

ARTICLE NUMBER & SERIES NAME
ARTIKELNUMMER & SERIENNAME
NUMÉRO D'ARTICLE & NOM DE LA SÉRIE



43559

DIMENSIONS
DIMENSIONEN
DIMENSIONS

all dimensions in mm | alle Größen in mm | toutes dimensions en mm

L = length | Länge | longueur

B = width | Breite | largeur

H = height | Höhe | hauteur

Ø = diameter | Durchmesser | diamètre

A = projection length | Ausladung | amplitude

ET = installation depth | Einbautiefe | profondeur utile

Base = base dimensions | Sockelmaße | dimensions de base

Attention! The dimensions relate solely to the sizes of the luminaire. Any air spaces that would be relevant for a safe operating of the lamp were not considered.

Achtung! Die Größen beziehen sich nur auf die Abmessungen der Leuchte. Etwaige Lufträume, die für einen sicheren Betrieb der Leuchte notwendig sind, werden nicht berücksichtigt.

Attention! Les dimensions se réfèrent à la taille de la lampe seulement. Espacements éventuels, que seraient importants pour une opération de la lampe sans danger, n'ont pas été considérés.

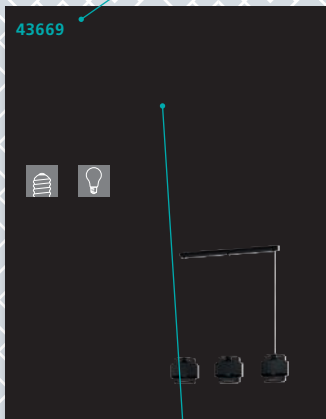

43669



43668

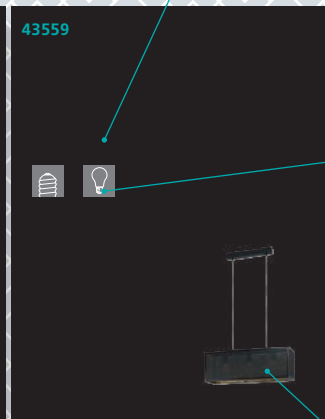

43559

PICTOGRAMMES
PIKTOGRAMME
PICTOGRAMMES

Technical details are represented as pictograms. An overview over all pictograms can be found on the next pages.

Technische Details werden als Piktogramme dargestellt. Eine Übersicht über alle Piktogramme finden Sie auf den nächsten Seiten.

Les détails techniques sont représentés sous forme de pictogrammes. Vous trouverez un aperçu de tous les pictogrammes dans les pages suivantes.

SKETCHES
SKIZZEN
CROQUIS

The sketches state the most meaningful dimensions. If a product is adjustable by will, a turquoise arrow marks this function and only the maximum dimensions are indicated.

Die Bemaßung der Skizzen umfasst jeweils die aussagekräftigsten Größen. Bei verstellbaren Produkten kennzeichnet ein türkiser Pfeil diese Funktion und nur die maximalen Größen werden angegeben.

Les dimensions des croquis comprennent les plus représentatives. Si un produit est réglable au choix, une flèche turquoise affiche cette fonction et rien que les dimensions maximales sont indiquées.

DESCRIPTION
BESCHREIBUNG
DESCRIPTION

The product description is composed as follows: luminaire type; enclosure material, enclosure colour / glass or shade material, glass or shade colour

Die Produktbeschreibung setzt sich wie folgt zusammen: Leuchtenart; Gehäusematerial, Gehäusefarbe / Schirm- bzw. Glasmaterial, Schirm- bzw. Glasfarbe

La description du produit est composée comme suit: type de luminaire; matériel de boîtier, couleur de boîtier / matériel de verre ou abat-jour, couleur de verre ou abat-jour

Trend & Style 2024/25 - Loft

173

HOW TO READ

ERKLÄRUNG

COMMENT LIRE



















1

PICTOGRAMMES PIKTOGRAMME PICTOGRAMMES

Technical details are represented as pictogrammes.

Technische Details werden als Piktogramme dargestellt.

Les détails techniques sont représentés sous forme de pictogrammes.

	Lumen Lumen Lumen		Not dimmable Nicht dimmbar Pas de gradation		Colour rendering index Farbwiedergabeindex L'indice de restitution de couleurs
	Not suitable as main light source Nicht als Hauptleuchtmittel geeignet Ne convient pas comme source lumineuse principale		Step dimmable Stufen dimmbar gradation par étapes		Beamangle Ausstrahlwinkel Angle de rayonnement
	Dimensions in mm Abmessungen in mm Dimensions en mm		Control unit Stufen dimmbar unité de contrôle		Day/night-sensor Tag/Nacht-Sensor Capteur jour/nuit
	Wattage Wattage Puissance		Lifetime Steuereinheit Durée de vie		Motion-sensor Bewegungsmelder Détecteur de mouvement
	Operating voltage Betriebsspannung Tension de fonctionnement		Selling Unit Verpackungseinheit Unité d'emballage		Motion-sensor & day/night-sensor Bewegungsmelder & Tag/Nacht-Sensor Détecteur de mouvement et détecteur jour/nuit
	Socket Sockel Douille		Comparative value of brightness to conventional light bulbs Vergleichswert der Helligkeit zu konventionellen Glühlampen Valeur comparative de la luminosité par rapport aux ampoules à incandescence conventionnelles		incl. battery inkl. Batterie incl. pile
	Dimmable Dimmbar Dimmable				

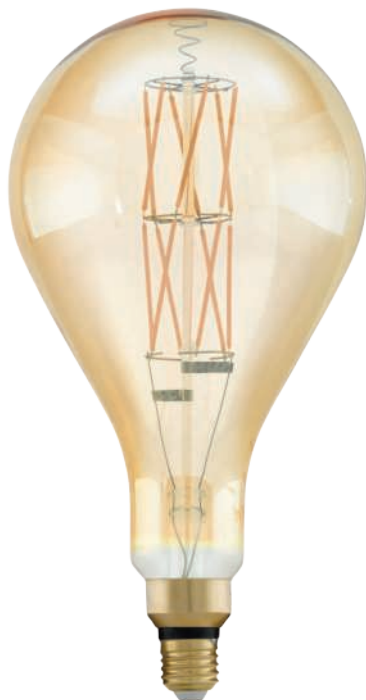

1

110111 E27-LED-PS160



806 lm

warm
WHITE

2100 K



L 320, Ø 160



8 W ~ 60 W



8 W



80 CRI



220-240V, 50/60Hz



E27



dimmable



15000 h



9 008606 228393













2

LIGHT COLOUR & KELVIN LICHTFARBE & KELVIN COULEUR LUMINEUX & KELVIN

The colours of the LED are represented as pictogrammes (see below), their luminous flux directly beneath. The luminous flux is quoted in lumen and describes the amount of light generated by the LED. The higher the value, the brighter is the lamp. Lumens are LED boards and are the light measurement value in bulbs.

Die Farben der LED werden als Piktogramm (siehe unten) dargestellt, deren Lichtstrom direkt darunter. Der Lichtstrom wird in Lumen gemessen und gibt die erzeugte Lichtmenge der LED an. Je höher der Wert, desto heller das Produkt. Lichtstromangaben (Lumen) sind Platinen- bzw. Leuchtmittelwerte.

Les couleurs de DEL ont représentés sous forme de pictogrammes, leur flux lumineux directement en dessous. L'unité de flux lumineux est le lumen et il mesure la quantité de lumière générée par les DEL. Plus la valeur est élevée, plus la lampe est lumineuse. Les lumens sont l'unité de mesure de l'intensité lumineuse des ampoules et des panneaux led intégrés.

 RGB	RGB RGB RGB	 RGB+NW	RGB + neutralwhite RGB + neutralweiß RGB + blanc neutral	 cold WHITE	cold white kaltweiß blanc froid
 RGB+W	RGB + white RGB + weiß RGB + blanc	 RGB+TW	RGB + tunable white RGB + tunable white RGB + tunable white	 neutral WHITE	neutral white neutralweiß blanc neutre
 RGB+WW	RGB + warmwhite RGB + warmweiß RGB + blanc chaud	 tunable WHITE	tunable white tunable white tunable white	 YELLOW	Yellow Gelb Jaune
 RGB+CW	RGB + coldwhite RGB + kaltweiß RGB + blanc froid	 warm WHITE	warm white warmweiß blanc chaud	 RED	Red Rot rouge

3

ENERGY EFFICIENCY LABELS ENERGIEEFFIZIENZ-LABEL LABEL DE L'EFFICACITÉ ÉNERGÉTIQUE

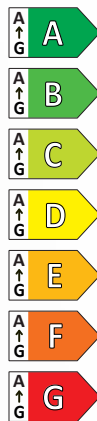
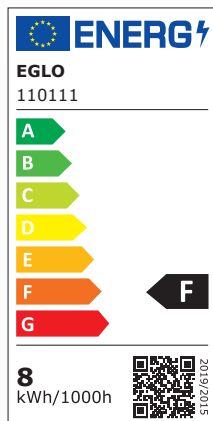

The new energy label must be indicated on all light sources with a luminous flux between 60 and 82,000 lumens and LED. This applies to lamps, LED modules and luminaires where the light source cannot be removed without destroying it. The energy spectrum ranges from A to G.

Das neue Energielabel muss auf allen Lichtquellen mit einem Lichtstrom zwischen 60 und 82.000 Lumen und LED angegeben werden. Dies gilt für Lampen, LED-Module und Leuchten, bei denen die Lichtquelle nicht zerstörungsfrei entnommen werden kann. Das Energiespektrum reicht von A bis G.

Le nouveau label énergétique doit être indiqué sur toutes les sources lumineuses dont le flux lumineux est compris entre 60 et 82 000 lumens et sur les LED. Cela s'applique aux lampes, aux modules LED et aux luminaires dont la source lumineuse ne peut être retirée sans être détruite. Le spectre énergétique va de A à G.



















The information on the label includes: / Die Angaben auf dem Etikett beinhalten: / Les informations figurant sur l'étiquette sont les suivantes :

- › Name/Trademark / Name/Warenzeichen / Nom/marque de commerce
- › Model / Modell / Modèle
- › Energy label scale A-G / Energielabel-Skala A-G / Échelle d'étiquetage énergétique A-G
- › Energy consumption for 1,000 hours of use / Energieverbrauch bei 1.000 Stunden Nutzung / Consommation d'énergie pour 1 000 heures d'utilisation
- › Energy efficiency class of the product / Energieeffizienzklasse des Produkts / Classe d'efficacité énergétique du produit
- › QR Code to EPREL (Product Database of the European Product Registry for Energy Labelling) / QR Code zur EPREL (Produktdatenbank der European Product Registry for Energy Labelling) / Code QR pour EPREL (base de données des produits du registre européen des produits pour l'étiquetage énergétique)

























LEGEND

PICTOGRAM PIKTOGRAMME PICTOGRAMME

SOCKETS FASSUNGEN DOUILLES

 LED	 G4	 G53
 2G7	 G5	 GU5,3 / MR16
 2G11	 G9	 GU10
 2GX13	 G10Q	 GX53
 E14	 G13	 GY6,35
 E27	 G23	 R7s

BULBS LEUCHTMITTEL AMPOULES

 E14 / C35	 E27 / A60 Halogen	 E27 / E140 Filament
 E14 / C35f	 E27 / R63 Halogen	 E27 / PS160 Filament
 E14 / D45	 E27 / A60 LED	 E27 / T30 Filament
 E14 / C35f LED	 E27 / A60 Filament	 E27 / T32 Filament
 E14 / D45 Halogen	 E27 / A65 LED	 G4 / T9
 E14 / C35 Halogen	 E27 / A75 Filament	 G4 / LT9
 E14 / T22	 E27 / G45 LED	 G4 / LT14
 E14 / C35 Filament	 E27 / G45 Filament	 G9
 E14 / C37 Filament	 E27 / G80 Filament	 G9 LED
 E14 / C35f Filament	 E27 / G95	 GU10
 E14 / C37f Filament	 E27 / G95 Filament	 GU10 LED
 E14 / P45 LED	 E27 / G125	 GU10 SMD LED
 E14 / P45 Filament	 E27 / G95 LED	 GX53 / LF75
 E14 / P50	 E27 / G200 Filament	LED LED board / LED Platine / LED bord
 E14 / ST48 Filament	 E27 / R63 LED	 MR16
 E14 / ST64 Filament	 E27 / ST48 Filament	 MR16 LED
 E14 / T20 LED	 E27 / ST64 Filament	 R7s / 78mm
 E27 / A60	 E27 / B80 Filament	 R7s / 118mm
 E27 / G90	 E27 / BR150 Filament	 R7s / 78mm LED
 E27 / QR63	 E27 / DP165 Filament	 R7s / 118mm LED

LIGHT COLOUR & LUMEN
LICHTFARBE & LUMEN
COULEUR LUMINEUX & LUMEN

The colours of the LED are represented as pictogrammes (see below), their luminous flux directly beneath. The luminous flux is quoted in lumen and describes the amount of light generated by the LED. The higher the value, the brighter is the lamp. Lumens are LED boards and are the light measurement value in bulbs.

Die Farben der LED werden als Piktogramm (siehe unten) dargestellt, deren Lichtstrom direkt darunter. Der Lichtstrom wird in Lumen gemessen und gibt die erzeugte Lichtmenge der LED an. Je höher der Wert, desto heller das Produkt. Lichtstromangaben (Lumen) sind Platinen- bzw. Leuchtmittelwerte.

Les couleurs de LED ont représentés sous forme de pictogrammes, leur flux lumineux directement en dessous. L'unité de flux lumineux est le lumen et il mesure la quantité de lumière générée par les LED. Plus la valeur est élevée, plus la lampe est lumineuse. Les lumens sont l'unité de mesure de l'intensité lumineuse des ampoules et des panneaux led intégrés.

	RGB RGB RGB
	RGB + white RGB + weiß RGB + blanc
	RGB + warmwhite RGB + warmweiß RGB + blanc chaud
	RGB + coldwhite RGB + kaltweiß RGB + blanc froid
	RGB + neutralwhite RGB + neutralweiß RGB + blanc neutrale

	RGB + tunabel white RGB + tunabel white RGB + tunabel white
	tunable white tunable white tunable white
	warm white warmweiß blanc chaud
	cold white kaltweiß blanc froid
	neutral white neutralweiß blanc neutre

SWITCHES & SENSORES
SCHALTER & SENSOREN
INTERRUPTEUR & CAPTEURS

	incl. cable & plug inkl. Kabel & Stecker câble & connecteur inclus
	internal dimmer eingebauter Dimmer variateur intégré
	button switch Druckknopf interrupteur de pression
	function switch Funktionsschalter interrupteur fonction
	rocker switch Wippschalter interrupteur à bascule
	pedal dimmer Trittdimmer variateur à pied

	pedal switch Trittschalter interrupteur à pied
	cable switch Kabelschalter interrupteur à câble
	incl. cable & plug transformer inkl. Kabel & Stecktransformator câble & transformateur à prise
	remote control Fernbedienung télécommande
	Day & Night Sensor Tag & Nacht Sensor sensor jour & nuit
	sensor Sensor sensor

	swedish plug Stecker Schweden connecteur swede
	"Touch me" ON/OFF "Touch me" EIN/AUS "Touch me" ON/OFF
	"Touch me" ON/OFF & dimm "Touch me" EIN/AUS & Dimmen "Touch me" ON/OFF & graduable
	pull switch Zugschalter interrupteur à bascule
	Timer - automatic on/off Zeitschaltuhr - automatisches Ein- & Ausschalten minuterie - peut être éteint et allumé automatiquement

FUNKTIONS & COMFORT
FUNKTIONEN & KOMFORT
FONCTIONS & COMFORT

	incl. battery inkl. Akku incl. pile
	incl. battery inkl. Batterie incl. pile
	battery specifications Batteriespezifikationen spécifications des piles
	beam angle Ausstrahlwinkel angle de rayonnement
	corner mount possible Eckmontage möglich montage en coin possible
	CRI Colour Rendering Index

	cutout (in mm) Ausschnitt (in mm) perçage du panneau (en mm)
	dimmable dimmbar graduable
	not dimmable nicht dimmbar ne pas graduable
	replaceable LED austauschbare LED LED remplaçables
	loadable in kg belastbar in kg chargeable en kg
	packaging / delivery unit Verpackungs- / Liefereinheit unité d'emballage / de livraison

	shortable kürzbar réductible
	Voltage Volt Voltage
	Watt
	Flicker-Free Flacker-Frei Sans Vacillement
	not suitable for general lighting nicht für die Allgemeinbeleuchtung geeignet n'est pas approprié pour l'éclairage général

PROTECTION CLASS
SCHUTZKLASSE
CLASSE DE PROTECTION

The protection class indicates to what extent the lamp is protected against electric shock. All lamps in this catalogue are at least protected with the protection class 1 - a higher class is specified in the information box of the respective lamp.

Die Schutzklasse gibt an, inwiefern ein Produkt gegen einen elektrischen Schlag gesichert ist. Alle Leuchten in diesem Katalog sind mit mindestens Schutzklasse 1 gesichert, bei höheren Klassen wird das Symbol im Infokasten der Leuchte angegeben.

La classe de protection indique, dans quelle mesure la lampe est protégé contre les chocs électriques. Tous les lampes dans ce catalogue sont protégées au moins avec la classe 1 - une classe plus élevée est indiquée dans l'information de la lampe.

	protection class 1: protective earthing Schutzklasse 1: Schutzerdung classe de protection 1: prise de terre
--	---

	protection class 2: protective insulation Schutzklasse 2: Schutzisolierung classe de protection 2: double isolation ou renforcée
--	--

	protection class 3: protective low voltage Schutzklasse 3: Schutzkleinspannung classe de protection 3: très basse tension de sécurité
--	---

PROTECTION RATING
SCHUTZGRAD
INDICE DE PROTECTION

The protection rating ensures the operational safety of luminaires. The first number specifies the extent of the protection against the ingress of foreign bodies; the second number identifies the humidity protection grade. All luminaires in this catalogue are at least protected with the rating IP20 - a higher rating is specified in the information box of the luminaire.

Der Schutzgrad gewährleistet die Betriebssicherheit von Leuchten. Die erste Ziffer des IP Grades beschreibt den Schutzzumfang gegen das Eindringen von Fremdkörpern, die zweite Ziffer informiert über den Grad des Feuchtigkeitsschutzes. Alle Leuchten in diesem Katalog sind mit mindestens Schutzgrad IP20 gesichert, bei höheren Graden wird das Symbol im Infokasten der Leuchte angegeben.

L'indice de protection assure la sécurité opérationnelle des luminaires. Le premier chiffre indique à quel point la protection est efficace contre l'insertion de corps étrangers; le second chiffre indique quant à lui le degré de protection par rapport à l'humidité. Tous les luminaires dans ce catalogue sont protégés au moins avec l'indice IP20 - un indice plus élevé est indiqué dans l'information d'article.

	IP33
	IP44

	IP54
	IP65

	IP67
--	------

Look out for this Logo!

Achten Sie auf das Logo!

Soyez attentif au logo !

What is a forest?

A peaceful oasis, the green lungs of the world, and an adventure playground for children of all ages!

The Forest Stewardship Council® (FSC®) is a global, not-for-profit organisation dedicated to the promotion of responsible forest management worldwide. The FSC® defines standards for responsible forest management in accordance with established principles that are developed and supported by stakeholders from the environmental, social and economic spheres. For more information, please see www.fsc.org.

Was ist Wald für uns?

Eine Oase der Ruhe, die Lunge der Welt oder ein Abenteuerspielplatz für große und kleine Kinder!

Das Forest Stewardship Council® (FSC®) ist eine globale, gemeinnützige Organisation, mit dem Zweck verantwortungsvolle Waldbewirtschaftung weltweit zu fördern. FSC® definiert Standards für eine verantwortungsvolle Waldbewirtschaftung nach festgelegten Prinzipien, die von Interessenvertretern aus den Bereichen Umwelt, Soziales und Wirtschaft entwickelt und getragen werden. Für weitere Informationen besuchen Sie www.fsc.org.

Que représente la forêt pour nous ?

Une oasis de calme, les poumons du monde ou un terrain de jeu d'aventure pour les enfants de tous âges !

Le Forest Stewardship Council® (FSC®) est une organisation internationale à but non lucratif dont le but est de promouvoir une gestion forestière responsable dans le monde entier. Le FSC® définit des normes de gestion forestière responsable selon des principes établis qui sont développés et soutenus par les parties prenantes des secteurs environnemental, social et économique. Pour plus d'informations, veuillez consulter www.fsc.org.

Look out for FSC® -certified products!
Achten Sie auf FSC® -zertifizierte Produkte!
Soyez attentif aux produits certifiés FSC® !



The mark of
responsible forestry

DIGITAL CATALOGUE

This year, we are also making the Trend & Style catalogue in front of you available on-line, including lots of extra information and additional features. In addition to search and filter functions, the online catalogue includes extensive product photos, videos and additional information, complementing the paper edition wonderfully.

Take a look at

<https://catalogue.eglo.com>

In diesem Jahr präsentieren wir den vor Ihnen liegenden Trend & Style Katalog wieder als Online-Katalog mit vielen Zusatzinformationen und zusätzlichen

Features. Neben Such- und Filterfunktionen bietet der Online-Katalog mit reichhaltigen Produktabbildungen,

Videos und zusätzlichen Informationen einen erheblichen Mehrwert zur gebundenen Ausgabe. Klicken Sie sich rein unter

<https://catalogue.eglo.com>

Cette année, nous présentons le catalogue Trend & Style devant vous pour la première fois en tant que catalogue en ligne avec de nombreuses informations complémentaires et des informations complémentaires Caractéristiques. Cette version contient de nombreuses informations et fonctionnalités complémentaires. Outre les fonctionnalités de recherche et de filtrage, le catalogue en ligne propose de nombreuses illustrations de produits, des vidéos et des informations complémentaires : une valeur ajoutée considérable par rapport à la version papier.

Cliquez ici pour le découvrir :

<https://catalogue.eglo.com>

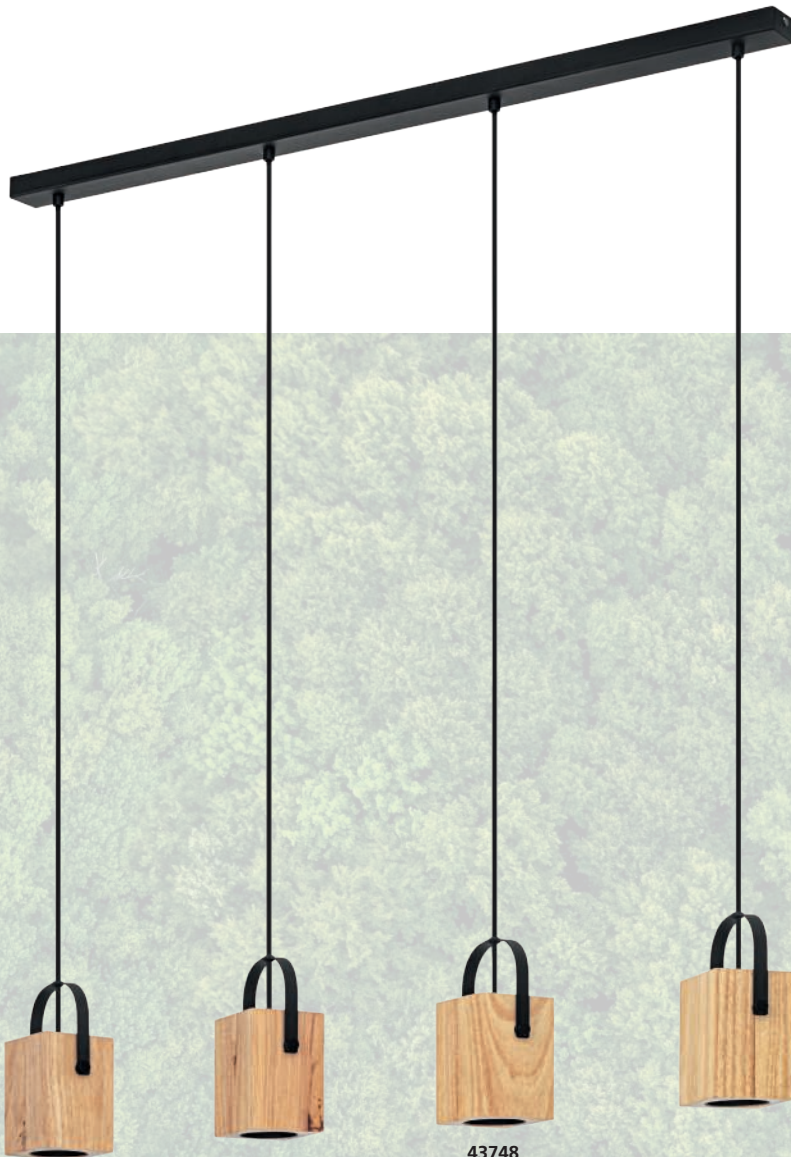

43748



REGISTER

SERIES NAMES

SERIENNAMEN

NOME DE PRODUITS

NAME NAME NOM	PAGE SEITE PAGE	NAME NAME NOM	PAGE SEITE PAGE	NAME NAME NOM	PAGE SEITE PAGE	NAME NAME NOM	PAGE SEITE PAGE
ADWICKLE	205	BUDDON	102	DELLOW	16-17	KILBURN	258
ALDERNEY	204	BUTTERBURN	186-187	DEMBLEBY	224-225	KILNSDALE	74
ALSAGER	200-201	CALARI	274	DOLWEN	196-197	KINROSS	253
AMSFIELD	227	CALLOW	100	EBURY	39	KIRKCOLM	230
AMSFIELD 1	228	CARLTON	124-127	EDALE	246	LACEY	84-85
ANWICK	214-215	CARLTON 1	114-116 120, 122	ELSWICK	56	LANTADA	163
ANWICK 1	216	CARLTON 2	134	EMBLETON	51	LAVISTER	208
ASBY	195	CARLTON 4	118	EVESHAM	72-73	LAYHAM	70
AUCKLAND	42	CARLTON 5	119	FAMBOROUGH	92-93	LEOMINSTER	219
AUSTELL	156	CARLTON 6	118	FELIXKIRK	262	LINTMILL	142
AYCLIFFE	230	CARLTON 7	116-117	FEMBARO	56	LITTLETON	96-97
AYESGARTH	226	CARLTON-P	122	GARGRAVE	243	LONGCINO	52
AYLES	87	CASTANUELO	144-145	GATEBECK	64	LUBENHAM	36-37
BAILRIGG	102-103	CATTERICK	22	GLYNEATH	220	LUBENHAM 1	36
BARLASTON	198-199	CAWTON	68-69	GRANTHAM 1	40	LYDNEY	220
BARNSTAPLE	32-35	CHARTERHOUSE	54	GRIZEDALE	262	MACCLES	66-67
BARNSTAPLE 1	30-31	CHESTER	164	HALKIN	90	MANBY	10-11
BASILDON	98-99	CHESTER 1	164	HAPTON	165	MARDYKE	50-51
BASILDON 1	98	CHIEVELEY	88-89	HARBOROUGH	72	MARFORD	232
BAZELY	173	CHISLE	255	HAXEY	230	MARYWELL	212-213
BELGRAVE	188	CLAVERDON	225	HETTONLE	231	MATLOCK	176-179
BIDFORD	163	CLEVEDON	153	HORNWOOD	82-83	MEDIOUNA	232
BORDESLEY	222-223	CONSETT	90-91	HORNWOOD 1	162	MIDSUMER	182-183
BOYLE	80	COPLEY	166-167	HORNWOOD 2	78	MILLIGAN	6
BRADFORD	244	CORETTO 2	165	HYKEHAM	218-219	MINTING	191
BRADFORD 1	245	COVALEDA	48	IKESTON	24-25	MUMBLES	265
BRAMERTON	86-87	CRANLEY	272	JADIDA	268	NAFFERTON	94-95
BRIDEKIRK	269	CRANLEY 1	272	KENSAL	242	NEWTOWN	154-155

NAME NAME NOM	PAGE SEITE PAGE	NAME NAME NOM	PAGE SEITE PAGE	NAME NAME NOM	PAGE SEITE PAGE
NIMLET	257	SOUTHERY	140-141	WINKWORTH 1	38
NOHALES	19	SPEKE	26	WOOTTON	252
OLDBURY	58	STAVERTON	269	WRINGTON	168-169
OXPARK	184-185	STILLINGTON	136-137	WRINGTON 1	171
PADSTOW	257	STILLINGTON 1	138-139	YORTH	273-274
PALMORLA	113	STOCKBURY	259	YOUNGSTOWN	251
PERSLEY	206-207	STRAITON	130		
PLIMSOLL	159	STYPE	128-129		
POCKLEY	102	SUMMERHILL	192,194		
POMPEYA	171	SURFLEET	238		
PONTEFRACT	9	TABLEY	234-235		
PRESTWICK	63	TAKELEY	28		
PRESTWICK 2	62-63	TALBOT 2	268		
PRIDDY	45-46	TARBES	134,146-151		
PRIDDY 1	42	TARLE	256		
RAMPSIDE	248, 250	TOOTHILL	53		
REDCLIFFE	20	TOWNSHEND	104-109		
RINROE	12-13	TOWNSHEND 2	247		
ROCCAMENA	152	TOWNSHEND 4	59-61		
RODING	254	TOWNSHEND 5	110 112-113		
ROSLEY	236-237	TREBURLY	48		
ROUNDHAM	14	TRURO 1	40		
SALLICANO	173	TRURO 2	40,42		
SANDBACH	266	TWICKEN	174-175		
SEDBERGH	27	VERNHAM	133		
SHERBURN	101	VINOZA	242		
SHIREBROOK	31	WAVERTON	160-161		
SIRUELA	210-211	WILMCOTE	56		



REGISTER

ARTICLE NUMBER
ARTIKELNUMMER
NUMÉROS D'ARTICLE

NUMBER NUMMER NUMÉRO	PAGE SEITE PAGE	NUMBER NUMMER NUMÉRO	PAGE SEITE PAGE	NUMBER NUMMER NUMÉRO	PAGE SEITE PAGE	NUMBER NUMMER NUMÉRO	PAGE SEITE PAGE	NUMBER NUMMER NUMÉRO	PAGE SEITE PAGE	NUMBER NUMMER NUMÉRO	PAGE SEITE PAGE
12552	286	43313	214	43517	82	43632	167	43739	101	43811	265
12553	286	43318	251	43518	82	43633	166	43743	95	43812	265
12554	287	43319	251	43519	83	43634	166	43744	94	43813	265
12588	287	43324	216	43521	83	43635	80	43745	95	43814	125
31073	274	43325	216	43522	59	43636	80	43746	95	43815	125
31075	274	43326	216	43523	60	43642	242	43748	87	43816	141
31961	211	43331	168	43524	60	43643	50	43749	87	43817	140
31964	210	43333	168	43525	61	43644	51	43751	86	43818	140
31965	210	43344	269	43526	61	43645	50	43752	86	43819	140
31966	210	43358	130	43527	255	43646	50	43753	86	43821	27
31991	211	43359	130	43528	255	43653	257	43754	87	43822	27
31992	211	43361	130	43531	17	43656	236	43755	100	43823	242
32468	169	43365	56	43532	17	43657	236	43756	100	43824	242
32539	274	43377	171	43533	17	43658	237	43758	272	43825	176
33163	105	43393	232	43534	20	43659	237	43766	136	43826	177
43001	120	43398	215	43535	20	43668	173	43767	136	43827	178
43002	120	43399	118	43537	20	43669	173	43768	137	43828	178
43004	134	43413	92	43541	88	43671	78	43769	136	43829	178
43057	118	43414	93	43542	89	43678	147	43772	22	43832	74
43058	118	43415	93	43543	89	43679	146	43773	22	43833	74
43077	119	43416	93	43544	89	43681	147	43775	205	43834	74
43096	169	43424	82	43549	63	43682	147	43776	205	43835	175
43113	230	43426	162	43558	83	43692	128	43777	205	43836	175
43126	56	43427	162	43559	173	43693	129	43781	246	43837	175
43152	59	43431	30	43561	28	43695	128	43782	246	43838	174
43159	72	43432	30	43562	28	43696	129	43783	246	43839	174
43168	36	43433	30	43569	98	43704	104	43784	204	43841	174
43184	48	43434	31	43591	252	43705	104	43785	204	43842	177
43192	248	43435	38	43592	252	43706	105	43786	204	43843	179
43194	248	43436	38	43594	252	43715	117	43787	19	43844	177
43195	248	43443	144	43599	145	43716	116	43788	19	43845	256
43197	250	43461	98	43603	16	43717	117	43789	19	43846	116
43216	222	43462	98	43604	16	43718	117	43791	272	43847	159
43217	223	43463	99	43605	16	43721	26	43794	11	43848	159
43218	222	43464	99	43606	78	43722	26	43795	10	43849	159
43219	223	43466	70	43611	85	43723	227	43796	10	43851	218
43231	222	43468	70	43612	84	43724	90	43797	11	43852	219
43252	225	43469	70	43613	85	43725	91	43798	90	43853	218
43256	250	43481	133	43614	85	43726	31	43799	90	43854	218
43261	225	43482	133	43618	254	43728	24	43801	273	43855	219
43262	224	43483	133	43619	254	43729	25	43802	273	43863	228
43263	224	43499	255	43621	39	43731	24	43803	273	43864	228
43264	225	43511	107	43622	39	43732	25	43804	73	43865	228
43292	269	43512	107	43623	245	43733	62	43805	72	43866	226
43304	171	43513	106	43626	6	43734	63	43806	73	43867	226
43305	171	43514	108	43627	6	43735	84	43807	73	43868	231
43311	214	43515	108	43628	6	43736	99	43808	145	43869	230
43312	215	43516	108	43631	166	43738	101	43809	145	43871	230

NUMBER NUMMER NUMÉRO	PAGE SEITE PAGE	NUMBER NUMMER NUMÉRO	PAGE SEITE PAGE	NUMBER NUMMER NUMÉRO	PAGE SEITE PAGE	NUMBER NUMMER NUMÉRO	PAGE SEITE PAGE	NUMBER NUMMER NUMÉRO	PAGE SEITE PAGE	NUMBER NUMMER NUMÉRO	PAGE SEITE PAGE
43872	220	43956	66	44044	212	44114	163	49646	152	110091	281
43873	220	43958	67	44045	213	44115	163	49647	34	110094	282
43874	238	43959	67	44046	212	49024	122	49648	32	110109	292
43878	45	43961	198	44047	213	49026	122	49649	33	110111	292
43883	219	43962	199	44051	96	49081	134	49652	32	110112	293
43885	262	43963	14	44053	96	49142	153	49653	32	110233	291
43886	262	43964	14	44054	97	49213	244	49717	268	110234	291
43891	9	43965	12	44055	97	49238	40	49718	34	110267	289
43892	9	43966	12	44056	36	49243	42	49722	34	110268	289
43895	191	43967	13	44057	36	49247	40	49724	253		
43896	13	43968	12	44058	37	49248	42	49762	51		
43898	102	43973	199	44059	37	49254	114	49764	268		
43901	103	43974	234	44062	109	49257	127	49771	227		
43902	103	43975	235	44063	192	49258	126	49772	227		
43903	103	43976	235	44064	192	49259	126	49812	63		
43904	102	43977	234	44065	192	49283	244	49819	40		
43908	124	43978	234	44066	194	49284	244	49859	61		
43909	124	43979	266	44067	194	49386	164	49878	114		
43921	258	43981	266	44071	208	49392	54	49927	247		
43922	258	43982	266	44072	208	49393	54	49931	122		
43923	258	43984	200	44073	208	49394	54	49932	120		
43925	139	43985	200	44074	110	49446	156	49933	126		
43926	138	43986	201	44075	110	49447	156	49991	115		
43927	138	43987	200	44076	112	49448	156	49992	115		
43928	138	43992	37	44077	112	49449	165	49994	115		
43929	243	43994	196	44078	110	49456	259	49997	114		
43931	262	43995	197	44079	113	49464	45	94187	148		
43932	191	43996	196	44081	113	49466	45	94188	148		
43933	191	43997	196	44082	105	49468	46	94189	149		
43934	238	43998	182	44085	58	49469	46	94191	148		
43935	186	43999	183	44086	58	49471	46	94192	149		
43936	187	44001	182	44088	257	49472	154	94193	151		
43937	187	44002	182	44089	257	49474	155	94194	150		
43938	186	44003	53	44091	64	49477	154	94195	150		
43939	186	44004	53	44092	64	49478	154	94196	151		
43941	184	44005	160	44093	64	49479	155	94742	165		
43942	184	44006	160	44094	113	49481	155	110029	283		
43943	184	44007	160	44095	232	49487	134	110031	283		
43944	185	44008	161	44096	232	49492	42	110051	277		
43945	185	44009	161	44098	163	49495	52	110052	277		
43946	199	44012	220	44099	106	49496	52	110053	277		
43948	68	44013	102	44102	188	49519	164	110055	278		
43949	68	44014	195	44103	188	49564	56	110057	278		
43951	69	44015	195	44104	188	49617	48	110058	278		
43952	69	44027	142	44105	206	49618	48	110079	281		
43953	68	44028	142	44106	207	49619	35	110083	281		
43954	69	44029	142	44107	206	49644	152	110085	282		
43955	67	44043	213	44108	206	49645	152	110088	282		

NOTES

NOTIZEN
NOTES

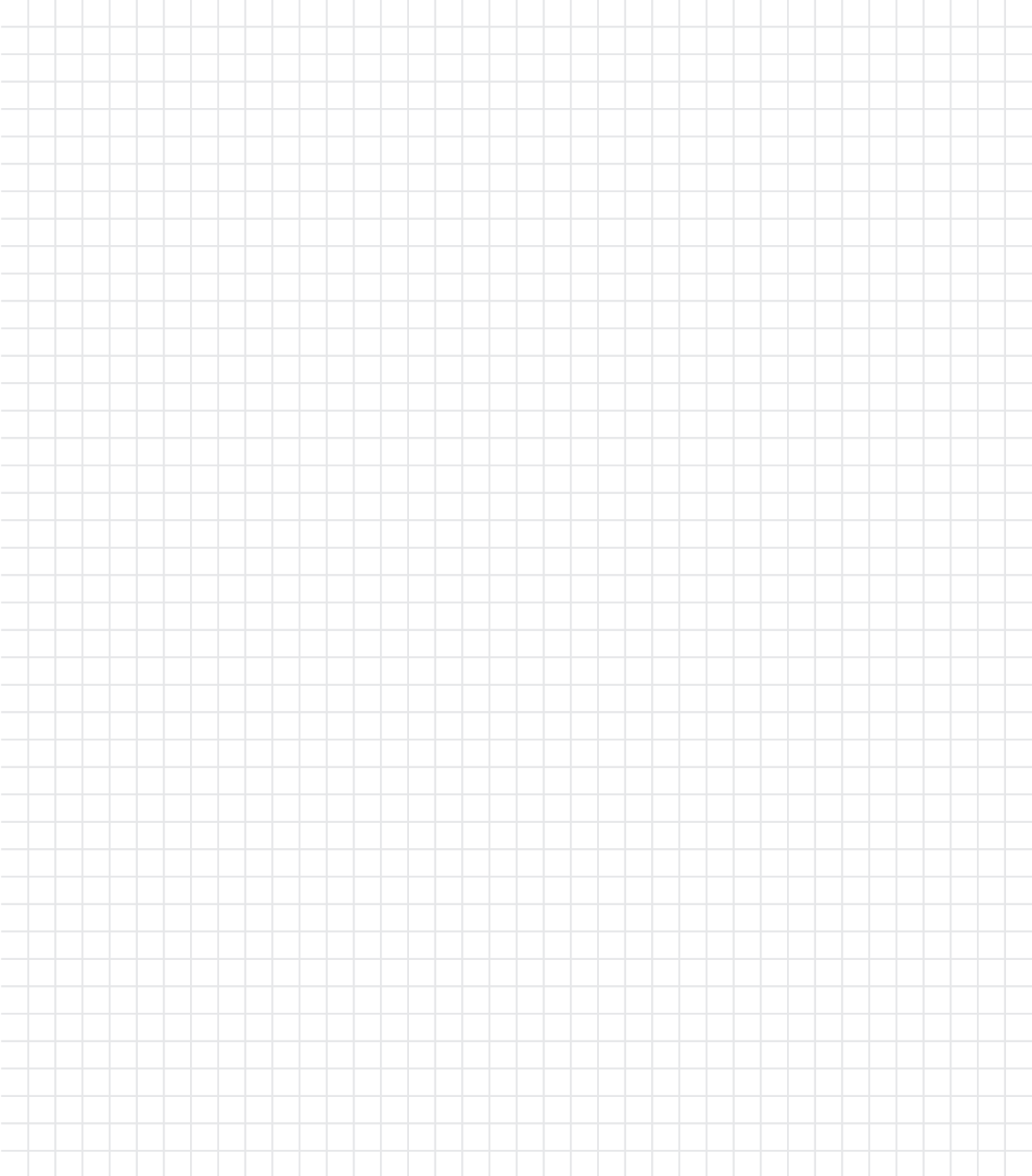

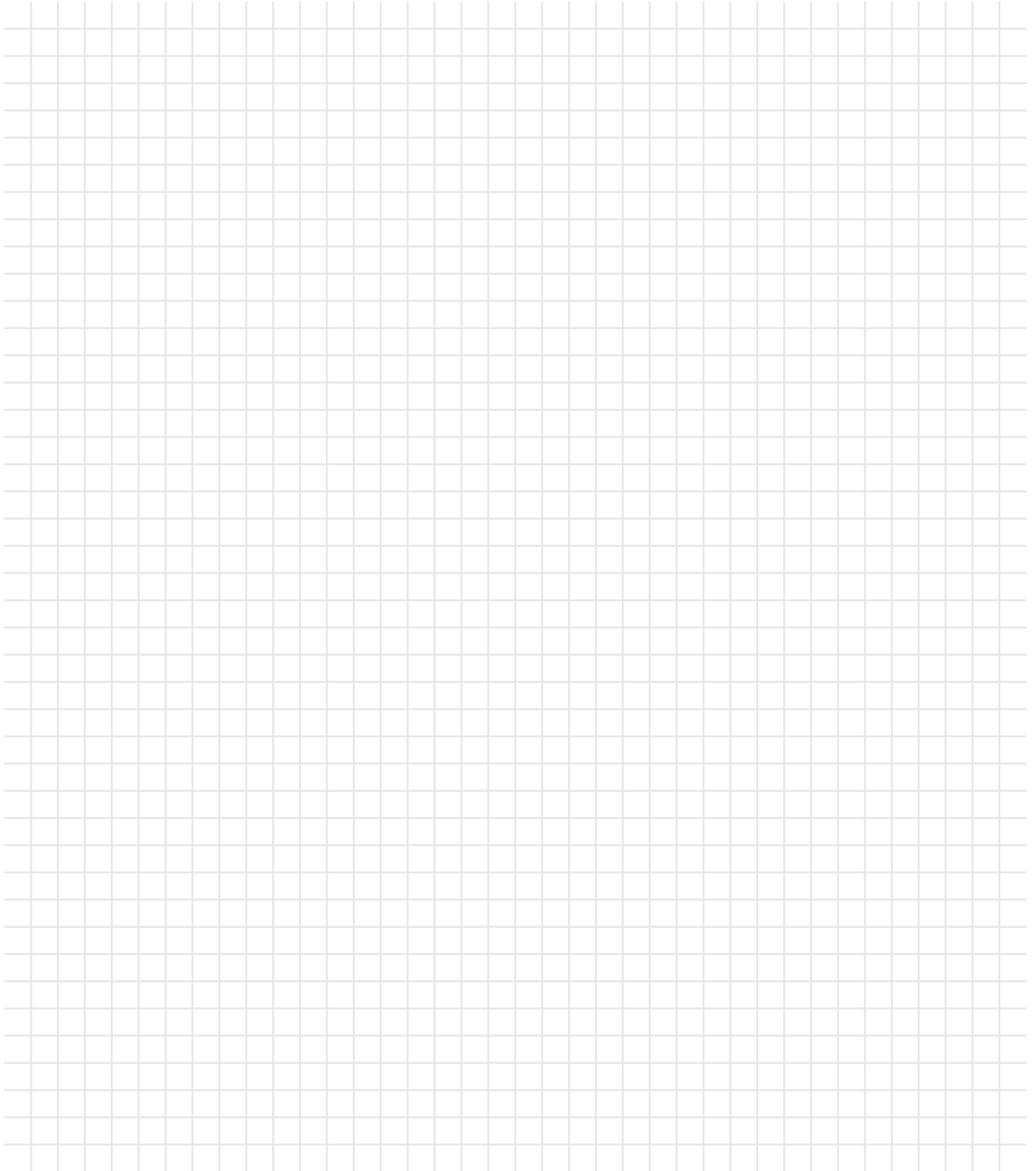

NOTES

NOTIZEN
NOTES

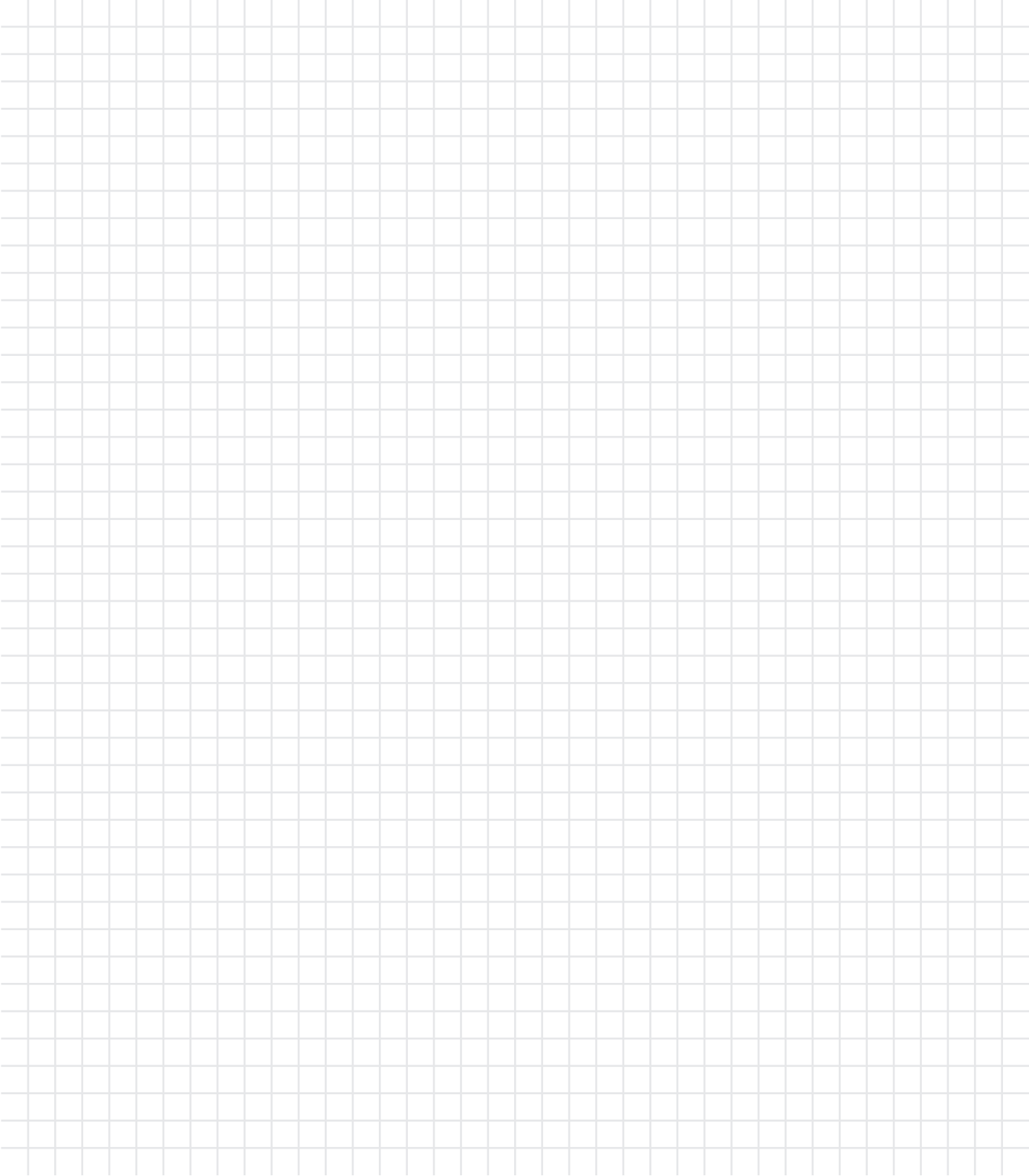

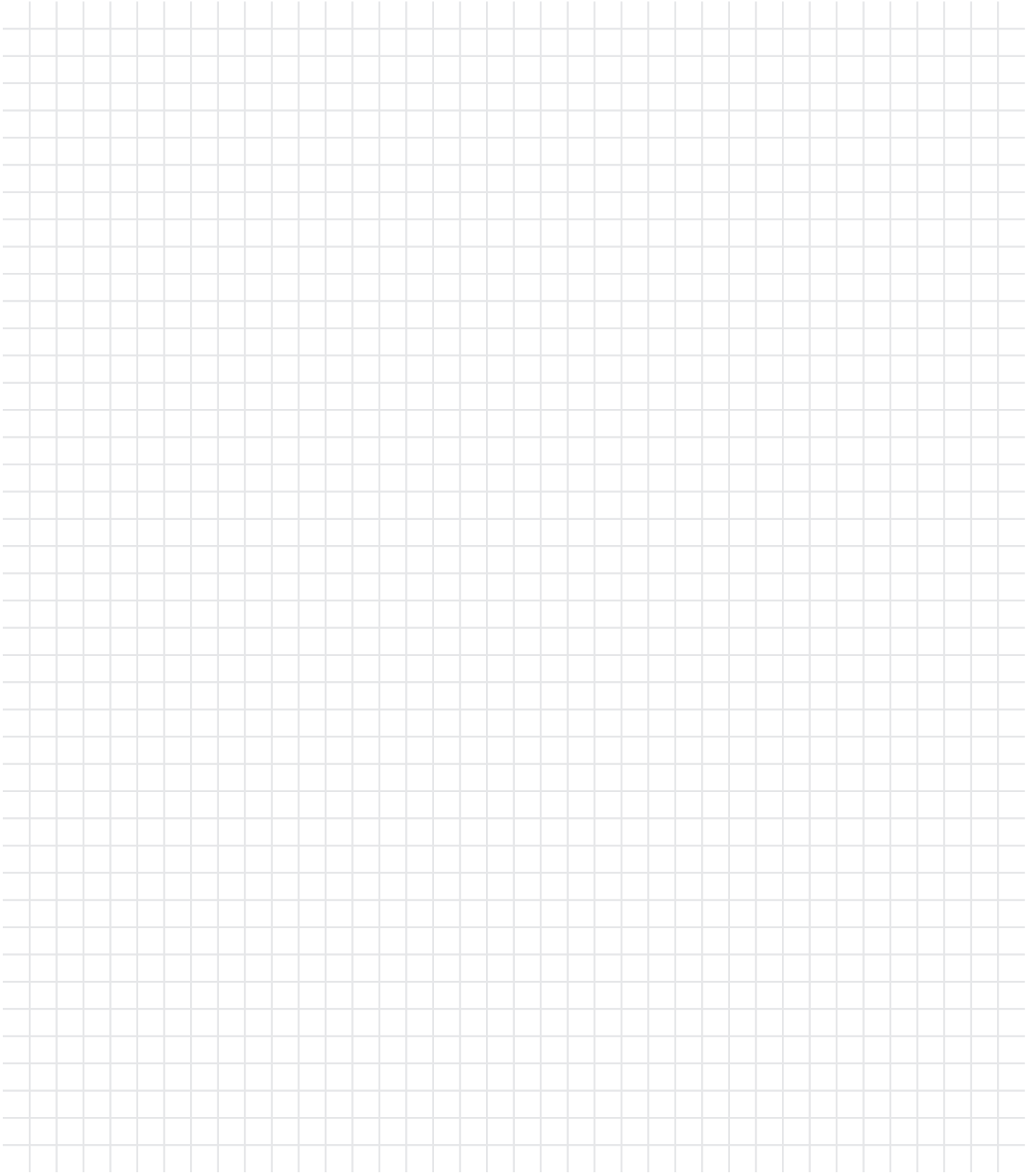



All previous catalogues and price lists are no longer valid with the issue of this catalogue. Errors, misprints, model and price changes and technical modifications are reserved. We deliver based on our terms of delivery and payment. Our products comply with the European light norm EN60598. Products with the ENEC test mark are conforming to the guide line 2006/95/EG. Products with additional safety remarks (e.g protection class, IP) are identified within the product family with the relevant symbol and number. The content of this catalogue is protected under copyright law for EGLO Leuchten GmbH. All rights reserved. Our specific written consent must be obtained before using any illustrations and texts. The pictures are 4C prints and may differ from the original. The product pictures and ambiences in this catalogue can deviate from reality, and they do not necessarily concur with the usual application of the product. EGLO does not assume liability for the correctness, completeness or the application depiction of the products and/or the product information.

Design, layout and composition:
EGLO GmbH, 6136 Pill - AUSTRIA
Print: Samson Druck GmbH, 5581 St. Margarethen - AUSTRIA
Pictures: EGLO, Adobe Stock, istockphoto.com, shutterstock.com

Mit diesem Katalog verlieren alle vorhergehenden Kataloge und Preislisten ihre Gültigkeit. Irrtümer, Druckfehler, Modell- und Preisänderungen sowie technische Änderungen vorbehalten. Wir liefern zu unseren Liefer- und Zahlungsbedingungen. Unsere Produkte entsprechen der europäischen Leuchtnorm EN 60598. Produkte mit dem ENEC Prüfzeichen sind konform mit der Richtlinie 2006/95/EG. Produkte mit weiteren Sicherheitshinweisen (zB. Schutzklasse, IP) sind mit Symbol und Zahl bei der Produktfamilie ausgezeichnet. Der Inhalt dieses Kataloges ist für die EGLO Leuchten GmbH urheberrechtlich geschützt. Alle Rechte sind vorbehalten. Bilder und Texte dürfen nicht ohne vorherige ausdrückliche, schriftliche Genehmigung verwendet werden. Die Abbildungen sind 4C Drucke und können vom Original abweichen.

Die Katalogbilder und die gezeigten Darstellungen der Produkte können von der Wirklichkeit abweichen und nicht den üblichen Produktanwendungen entsprechen. EGLO übernimmt keine Haftung für die Richtigkeit, Vollständigkeit und Anwendungsdarstellung der Produkte und Produktinformationen.

Gestaltung, Layout und Satz:
EGLO GmbH, A-6136 Pill - AUSTRIA
Druck: Samson Druck GmbH, 5581 St. Margarethen - AUSTRIA
Bilder: EGLO, Adobe Stock, istockphoto.com, shutterstock.com

Le présent catalogue remplace tous les catalogues et tarifs précédents. Sous réserve d'erreurs, de fautes d'impression, de modification des modèles et de changement de prix et de technique. Nous livrons sur la base de nos conditions de livraison et de paiement. Nos produits sont conformes aux normes européennes EN 60598 et portent le marquage CE. Les produits portant la marque ENEC sont conformes à la Directive 2006/95/EG. Les produits portant d'autres indications de sécurité (par exemple classe de protection, IP) sont identifiés par le symbole et le nombre correspondants dans la famille de produits.

Le contenu du présent catalogue est protégé pour la société EGLO Leuchten GmbH par un copyright. Tous droits réservés. Toute reproduction d'images et du texte est interdite sans autorisation explicite par écrit préalable. Les images sont imprimées en 4C et peuvent différer de l'original.

Les images des produits et les ambiences dans le catalogue peuvent dévier de la réalité et ne sont pas nécessairement en ligne avec l'usage habituel du produit. EGLO n'engage pas sa responsabilité sur la justesse des images et sur les informations relatives à l'usage pouvant être fait des produits.

Conception, maquette et composition :
EGLO GmbH, A-6136 Pill - AUSTRIA
Presse: Samson Druck GmbH, 5581 St. Margarethen - AUSTRIA
Images: EGLO, Adobe Stock, istockphoto.com, shutterstock.com

03-2024



printed according to the Austrian Ecolabel criteria for printed matter, UW-Nr. 837

gedruckt nach der Richtlinie "Druckerzeugnisse" des Österreichischen Umweltzeichens, UW-Nr. 837

imprimé selon la directive „Produits imprimés du label écologique autrichien, UW-Nr. 837





EGLO Leuchten GmbH
Heiligkreuz 22
A-6136 Pill
Austria
Tel. +43 (0) 5242 6996
Fax +43 (0) 5242 6996-972
info@eglo.com
www.eglo.com

KATTR24

my light | my style