



rabalux[®]
2023-24

DEAR BUSINESS PARTNER!

KEDVES PARTNERÜNK!
LIEBER GESCHÄFTSPARTNER!



Allow us to present the renewed **Rabalux** product catalogue that has been designed with your needs in mind. At the beginning of the catalogue product lines are introduced based on style.

Our renewed infographics and countless detail photos will bring our lamps even closer to you. In case of many products we also help you find the perfect light bulb for the respective product with lightsource recommendations.

In our catalogue containing more than **2,000** products we have increased the number of our SMART products, multifunctional ceiling lights with built-in LED and our outdoor solar lamps, while taking market needs into account.

Thanks to our creative design engineers, the number of our self-designed lamps has also increased – they have been marked with a “**designed by Rabalux**” label.

We hope you will find the perfect lamp that illuminates your home.



Engedje meg, hogy bemutassuk a **Rabalux** megújult termékkatalógusát, melyet az Ön igényeit szem előtt tartva alkottunk meg! Katalógusunk elején a termékcsaládok stílusok szerint kerülnek bemutatásra.

Megújult infografikáink, valamint a számtalan részletfotó még inkább testközelbe hozza lámpáinkat. Számos termékünknel fényforrás ajánlóval is segítjük megtalálni a lámpához tökéletesen illő fényforrást.

Több, mint **2000** terméket felölelő katalógusunkban a piaci igényeket figyelembe véve bővítettük SMART termékeink és beépített LED-es, többfunkciós mennyezeti, valamint kültéri napelemes lámpáink számát.

Kreatív tervező mérnökeinknek köszönhetően növekedett a saját tervezésű lámpáink száma is, melyeket „**designed by Rabalux**” jelzéssel láttunk el.

Reméljük, Ön is megtalálja a tökéletes lámpát, amellyel beragyoghatjuk otthonát!



Gestatten Sie uns, den erneuerten **Rabalux**-Produktkatalog vorzustellen, der auf Ihre Bedürfnisse zugeschnitten wurde. Am Anfang des Katalogs werden die Produktlinien nach Stil vorgestellt.

Unsere erneuerte Infografiken und zahllose Detailfotos bringen unsere Lampen noch näher zu Ihnen. Im Falle von vielen Produkten helfen wir auch mit Lichtquellenempfehlungen, damit Sie die perfekte Lichtquelle zum jeweiligen Produkt finden können.

In unserem Katalog, der mehr als **2000** Produkte enthält, haben wir die Anzahl unserer SMART Produkte, multifunktionellen Deckenleuchten mit eingebauten LED-Lichtquellen und unserer Außensolarleuchten unter Berücksichtigung der Marktanforderungen erhöht.

Dank unseren kreativen Design-Ingenieure hat sich auch die Anzahl unserer selbst entworfenen Lampen erhöht, die wir mit dem Zeichen „**designed by Rabalux**” versehen haben.

Wir hoffen, Sie werden die perfekte Lampe finden, mit der wir Ihr Zuhause anstrahlen können.

CONTACT • ELÉRHETŐSÉGEINK • KONTAKT

CENTRE/KÖZPONT/ZENTRALE



Magyarország/Hungary

RÁBALUX HEAD OFFICE
RÁBALUX VILÁGÍTÁSTECHNIKA ZRT.
VILÁGÍTÁSTECHNIKA GYÁRTÁS ÉS FORGALMAZÁS/
LIGHTING PRODUCTION AND DISTRIBUTION

9027 Győr, Körtefa u. 5.
Tel.: +36 96 526 716
E-mail: info@rabalux.com
www.rabalux.com

AFFILIATES/LEÁNYVÁLLALATOK/ZWEIGSTELLEN



Bulgaria

РАБАЛУКС ЕООД / RABALUX FOOD
ул. "Андрей Николов" №15,
1111 София,
България
Тел/Факс: +359 2 936 00 97
E-mail: infobg@rabalux.com
www.rabalux.bg



Croatia

RABALUX RASVJETA d.o.o.
Ulica grada Gospića 1a
10000 Zagreb
Tel.: +385 1 652 80 66
E-mail: infocro@rabalux.com
www.rabalux.hr



Czech Republic

RABALUX CZ Světidla s.r.o.
Kaštanová 141/a, 617 00 Brno,
Česká Republika
Tel.: +420 739 665 322
E-mail: infocz@rabalux.com
www.rabalux.cz



Hungary

Rábalux Magyarország Kft.
Magyarország
9027 Győr,
Körtefa u. 5.
Tel.: +36 96 526 716
E-mail: infohu@rabalux.com
www.rabalux.hu



Lithuania, Latvia, Estonia

UAB „Rabalux Baltic“
Bičiulių g. 29,
LT-14182 Bukiškis,
Vilniaus r. Lietuva
Tel.: +370 6161 3066
E-mail: infobaltic@rabalux.com
www.rabalux.lt



Poland

Rabalux Sp. z o.o.
ul. Sołtysia 119, 40-750 Katowice,
Polska
Tel.: +48 32 254 61 34
E-mail: infopl@rabalux.com
zamowienia@rabalux.com
www.rabalux.pl



Romania

SC RABALUX SRL
Cluj-Napoca, str. Fabricii,
nr. 93-103, jud. CLUJ
Romania
cod postal: 400632
Tel.: +40 264 456 040
E-mail: infofo@rabalux.com
www.rabalux.ro



Serbia

Rabalux SRB d.o.o.
Autoput br.20
11080 Beograd –
Zemun, Srbija
Mob: + 381 60 444 3977;
Tel.: +381(0)11 2013 986
E-mail: infosrb@rabalux.com
www.rabalux.rs



Slovakia

RABALUX SK. Svetidlá, s.r.o.
Alžbetínske nám. 328,
929 01 Dunajská Streda,
Slovenská Republika
Tel.: +421 31 551 54 04
E-mail: infosk@rabalux.com
www.rabalux.sk



Ukraine

ТОВ Рабалукс,
вул. Рилеева 4, м. Ужгород,
Україна, 88017
тел.: +38 0312 64 04 00,
моб.тел.: +38 067 310 05 20
E-mail: infoua@rabalux.com
www.rabalux.ua

OFFICIAL RESELLERS/MEGBÍZOTT VISZONTELADÓK/BEAUFTRAGTE WIEDERVERKÄUFER



Germany

Jens Stolte Leuchten
GmbH & Co.KG
Am Rischfeld 36
39164 Wanzleben - Börde
Tel.: +49 (0) 39204 915080
E-mail: info@ostfale.com
www.rabalux.de



Slovenia

Lagea d.o.o.
Brezina 19c
8250 Brežice
Republika Slovenija
Tel.: +386 70 292 70 20
E-mail: elmatis@lagea.si



Greece

ANASTASIADI SA
1km Katerini-Ganohora Road,
Katerini, 60100
Tel.: +30 2351039757
E-mail: eshop@anastasiadi.gr
B2C SITE: www.anastasiadi.gr
B2B SITE: www.anastasiadib2b.gr



Greece

S.MELISSOURGOS CO OE
8 Kourtiou St,
11146 Galatsi,
Tel.: +0030 2102136040
E-mail: info@melissourgos.com.gr
melissourgos.com.gr



Portugal

STORM LIGHT,LDA
Rua António Pereira Vidal Xavier nº,
3750-802 Valongo do Vouga,
Tel.: 234 661 068
E-mail: geral@storm-light.pt
www.storm-light.pt



Italy

Fra.Co.Distribuzione Srl
Sp1 km24,
90047 Partinico (PA)
Tel.: 0039 0915071547
E-mail: info@fracodistribuzione.it
www.fracodistribuzione.it



Finland

Focus Interiors Oy
Kuusipolku 35,
37150 Nokia
Tel.: +358 (0)10 3270 520
E-mail: info@focusinteriors.fi
www.focusinteriors.fi



United Kingdom

Lighting Direct
24-26 Vincent Ave,
Crownhill, Milton Keynes
Buckinghamshire, MK8 0AB
E-mail: customerservice@lighting-direct.co.uk
www.lighting-direct.co.uk

CONTACT • ELÉRHETŐSÉGEINK • KONTAKT



DESIGNED BY RABALUX



designed by
rabalux[®]

EN During the creation of our self-designed products it was an important consideration that they would comply with the current trends and market demands, but also stand out from our existing range, thus making it more diverse.

HU Saját tervezésű termékeink megalkotása során fontos volt, hogy illeszkedjenek az aktuális trendekhez és piaci igényekhez, ugyanakkor kiemelkedjenek meglévő kínáltunkból is, így színesítve azt.

DE Bei der Entwicklung unserer selbst entworfenen Produkten war es von grosser Bedeutung, dass sie den aktuellen Trends und Marktanforderungen entsprechen, sich aber auch von unserem bestehenden Angebot abheben und es dadurch vielfältiger machen.

BENITA

EN Our Benita product line is decorated with natural motifs: lamps emitting warm white light have a ginko leaf pattern, while the ones radiating natural white light feature art deco patterns.

HU Benita termékcsaládunkat a természet motívumai díszítik: ginkó levél a meleg fehér fényű, art déco mintázat a természetes fehér fényű tagokat.

DE Unsere Produktlinie Benita wurde mit Naturmotiven dekoriert: Lampen, die warmweißes Licht abstrahlen, haben ein Ginkoblattmuster, während Modelle, die mit neutralweißem Licht leuchten, wurden mit Mustern im Art Deco Stil versehen.



GREMIN, BITSI & PRUE

EN Representing the minimalist style, the Gremin, Prue and Bitsi product lines are based on simple geometric shapes, thus they can easily be fitted in our homes. Various colour temperatures make these products truly exciting. The Gremin and the Prue have a square, round and elliptic ground-form, and thanks to their multiple features, they are guaranteed to be a perfect choice for those who like lamps with a modern and pure design. Combining black colour with a hexagonal shape and symbolizing a honeycomb, the Bitsi products are considered unique even among our acrylic ceiling lights.

HU A Gremin, Prue és Bitsi minimalista stílusú termékcsaládok egyszerű geometriai formákra építenek, így könnyedén beilleszthetők otthonunkba, a különböző színhőmérsékletek pedig igazán izgalmassá varázsolják a termékeket. A négyzet, kör és ellipszis alapformájú Gremin és Prue sokrétű funkcióinak köszönhetően garantáltan tökéletes választás a modern és letisztult lámpák kedvelőinek. A fekete színt hatszög formával kombináló, méhsejtet szimbolizáló Bitsi termékek az akril mennyezeti lámpáink között is egyedülállónak számítanak.

DE Die Produktlinien Gremin, Prue und Bitsi vertreten den Minimalstil und basieren auf einfache geometrische Formen, so können mit Leichtigkeit in unser Zuhause integriert werden. Verschiedene Farbtemperaturen machen die Produkte wirklich spannend. Die Gremin und Prue haben eine quadratische, runde und elliptische Grundform, und dank ihren mannigfachen Funktionen sind sie sicherlich eine perfekte Wahl für diejenigen, die Lampen mit einem modernen und reinen Design mögen. Die Bitsi-Produkte, die die Farbe Schwarz mit einer sechseckigen Form kombinieren und eine Bienenwabe symbolisieren, gelten als einzigartig auch unter unseren Acryl Deckenleuchten.



DESIGNED BY RABALUX



ROTEM & BOROO

EN The product Boroo combines the industrial and geometric design. With its strongly masculine style it is an ideal choice into cool bachelor homes. Its form is made characteristic by the grating that is tilted at 45 degrees, making the scenery unique by the visual layering of the sides.
Our industrial-rustic style Rotem product family is characterised by real wood material and a black textile cable. The lampshades are made truly unique by the laser cut geometric patterns.

HU A Boroo termék ötvözi az ipari és geometrikus formavilágot. Erősen maskulin jellegével ideális választás vagány aglegény lakásokba. Formai jellegzetessége a 45 fokban döntött rácsozat, ami az oldalak vizuális egymásra rétegződésével teszi egyedivé a látványt.
A Rotem ipari és rusztikus stílusú lámpacsaládunk valódi faanyagból és fekete textilkábelrel rendelkezik. Lámpabúráját lézervágott geometrikus mintázat teszi igazán egyedivé.

DE Das Produkt Boroo kombiniert das industrielle mit dem geometrischen Design. Mit seinem stark maskulinen Charakter ist es eine ideale Wahl in verwegene Junggesellenwohnungen. Ihre Form wird durch das Gitterwerk charakteristisch gemacht, das um 45 Grad gekippt ist und die Szenerie mit der visuellen Übereinanderschichtung von den einzelnen Seiten einzigartig macht.
Unsere industrielle und rustische Lampenlinie Rotem ist durch echtes Holzmaterial und schwarzes Textilkabel geprägt. Die lasergeschnittenen geometrischen Mustern machen die Lampenschirme richtig originell.



LANNY & CALISTA

EN The distinctiveness of our industrial-style **Lanny** and **Calista** models is given by the various positions of the lamp heads, some of which hang long in the form of pendants and others are located close to the decorative base. The lower and upper light sources can be operated separately with the help of a wall switch.

HU Az ipusztíriális stílusú **Lanny** és **Calista** modellek különlegességét a lámpafejek különböző pozíciója adja, melyek közül néhány függeszték formájában hosszan lelóg, a többi pedig a dísztalpához közel helyezkedik el. Az alsó, illetve felső fényforrások csillárkapcsoló segítségével külön-külön is működtethetők.

DE Die Besonderheit der im Industriestil gefertigten **Lanny**- und **Calista**-Modelle ist die unterschiedliche Positionierung der Lampenköpfe, von denen einige in Form von Pendelleuchten tief hängen und andere sich in der Nähe des Baldachins befinden. Die unteren und oberen Lichtquellen können auch separat mit Hilfe eines Serienschalters betrieben werden.

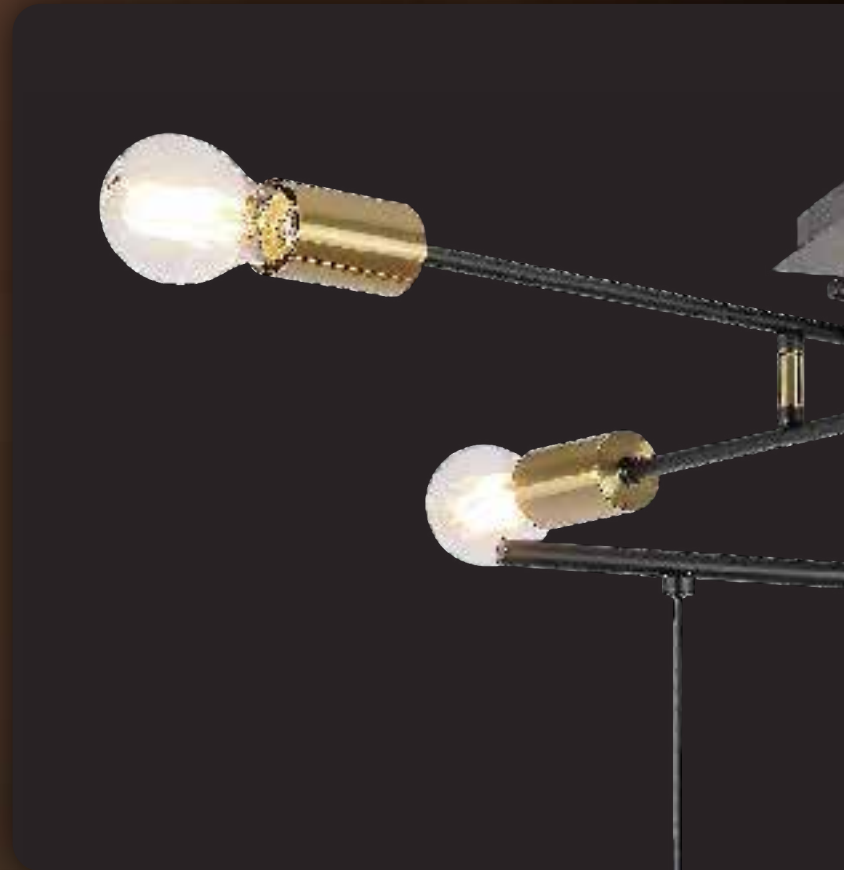

DESIGNED BY RABALUX

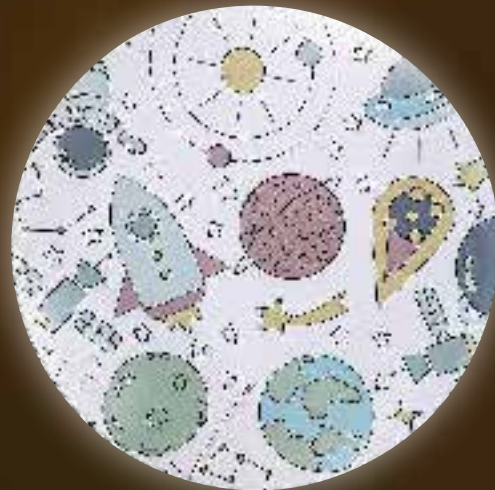

MINKA & AKALI

EN With its cheerful look the Akali lamp can be a perfect accessory for both children and adults. The composition of natural wood and acrylic is made truly exciting by the individually created sailboat and the dolphin that has been made with soft lines.

To 2 of the 5 members from our Minka product line have also been added a unique design. One of our large decorative lamps that are characterised by a modern design has a galaxy pattern, while the other one is decorated by a rainbow-heart pattern.

HU Az Akali lámpa a maga vidám megjelenésével tökéletes kiegészítő lehet gyermekek és felnőttek számára is egyaránt. A természetes fa és akril kompozícióját az egyedileg alkotott vitorlášajó és lágy vonalvezetéssel készült delfin teszi igazán izgalmassá.

5 tagú Minka termékcsaládunk 2 tagját egyedi designnal is felruháztuk, a nagy méretű, modern formavilágú dekorlámpáink egyike galaxis, másik pedig szivárványos-szívecske mintázatú.

DE Die Lampe Akali kann mit ihrem lustigen Aussehen ein perfektes Einrichtungsstück sowohl für Kinder, als auch für Erwachsenen sein. Die Komposition von natürlichem Holz und Acryl wird durch den individuell gestalteten Segler und den mit sanften Linien gefertigten Delphin wirklich spannend gemacht.

2 Mitgliededer von unseren 5 Minka-Produktlinien wurden auch mit einem einzigartigen Design versehen. Eine von unseren großen Dekorlampen, die durch ein modernes Design geprägt sind, hat eine Galaxiemuster, während die andere mit einem Regenbogen-Herzchen Muster dekoriert wurde.

HANKA

EN Members of our Hanka product family which are defined by blue as a basic colour and an astronaut theme will primarily enchant little boys, while their pink accented lights with butterfly-floral patterns will charm little girls.

HU Hanka termékcsaládunk kék alapszínű, űrhajós tematikájú tagjai elsősorban a kislányokat, rózsaszín hangsúlyos, pillangós-virágos mintájú lámpái pedig a kisfiúkat fogják elbűvölni.

DE Die Mitglieder unserer Produktfamilie Hanka, die durch eine blaue Grundfarbe und Astronautenmotiven gekennzeichnet werden, bezaubern in erster Linie kleine Jungen, während die Lampen mit rosa Akzenten, Schmetterlings- und Blumenmustern kleine Mädchen verzaubern werden.



CATHY, SHEPHERD & LEON

EN Our Cathy, Shepherd and Leon children's lamps have been inspired by the animal kingdom, so they will surely seize the imagination of the youngest ones. You can find both general and additional lighting among the members of all three product families.

HU Cathy, Shepherd és Leon gyermeklámpáinkat az állatvilág inspirálta, így biztosan magukkal ragadják a legkisebbek képzeletét. Mindhárom család tagjai között találhatunk általános és kiegészítő világítást egyaránt.

DE Unsere Kinderlampen Cathy, Shepherd und Leon wurden von der Fauna inspiriert, so werden sie die Fantasie der Jüngsten sicherlich anregen. Unter den Mitgliedern aller drei Produktfamilien befindet sich sowohl allgemeine als auch zusätzliche Beleuchtung.

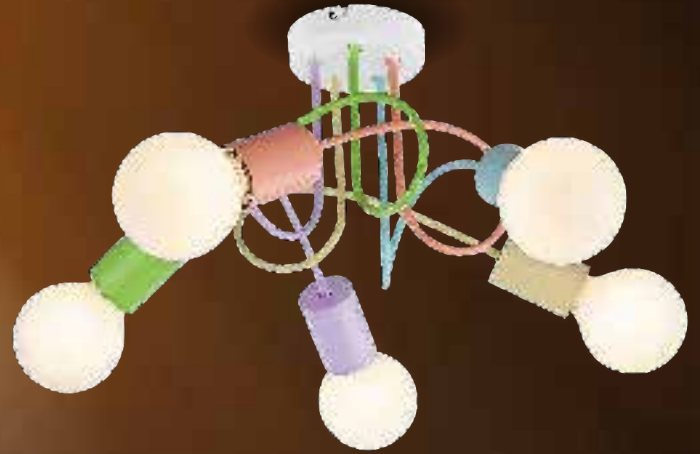

LINETT

EN Our **Linett** product is characterised by a sleek style, pastel colours as well as round and curved shapes, therefore they also come through as children's or youngster's lamps.

HU **Linett** termékeinket letisztult stílus, pasztellszínek, valamint kerek, íves formák jellemzik, így gyermek- és ifjúsági lámpákként is megállják helyüket.

DE Unsere **Linett** werden durch einen schlichten Stil, Pastellfarben, runde und geschwungene Formen bezeichnet, deshalb können sie gerne auch als Kinder- oder Jugendleuchten eingesetzt werden.



designed by
rabalux®

Look for the “**designed by Rabalux**” label in our catalogue!

Keresse a „**designed by Rabalux**” jelzést katalógusunkban!
Suchen Sie das Zeichen „**designed by Rabalux**” in unserem Katalog!

Best regards • Üdvözlettel • Mit freundlichen Grüßen

Fojtyik-Bendig Judit & Máj Szabolcs & Horváth Gergő

Product development engineers of Rabalux • a Rábalux termékfejlesztő mérnökei
Produktentwicklungs-Ingenieure von Rabalux

01

**PRODUCT
FAMILIES**
Termékcsaládok
Produktfamilien

12-221

02

SPOTS
Spotok
Spots

222-271

03

**SMART AND
LED LIGHTS**
Okos és LED lámpák
Smart und LED
Leuchten

272-355

04

**WALL AND
CEILING LAMPS,
PENDANTS**
Fali- és
mennyezetlámpák,
függeszékek
Wand- und
Deckenleuchten,
Pendelleuchten

356-385

05

**FLOOR AND
TABLE LAMPS**
Álló- és
asztali lámpák
Steh- und
Tischlampen

386-433



06

**CHILDREN AND
DECORATIVE
LAMPS**

Gyermek és
dekor lámpák
Kinder- und
Dekorleuchten

434-457

07

**BATHROOM,
PICTURE AND
CABINET LIGHTS**

Fürdőszobai,
kép- és pultmegvilágító
lámpák
Badleuchten,
Bildbe- und
Arbeitsflächenbeleuchtung

458-501

08

**RECESSED
AND
SURFACE
MOUNTED
LIGHTING**

Be- és ráépíthető
lámpák
Ein- und
Aufbauleuchten

502-525

09

**OUTDOOR
LAMPS**

Kültéri lámpák
Aussenleuchten

526-635

10

DATA

Adatok
Daten

636-672



01

PRODUCT FAMILIES

TERMÉKCSALÁDOK

PRODUKTFAMILIEN



LEANDROS

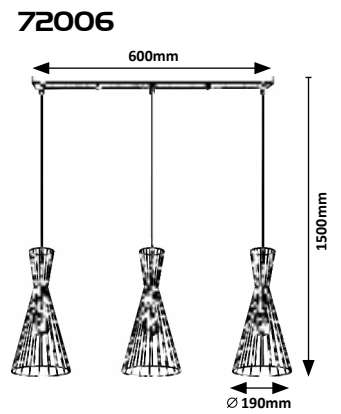
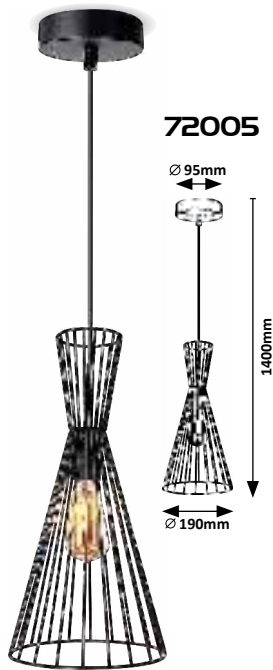

72005

 E27 / 1x max. 60W
IP20
matte black



72006

 E27 / 3x max. 40W
IP20
matte black



EMRYS

TEXTILE
CABLE

New

72111

∅ 120mm

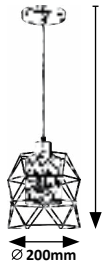

72113

575mm

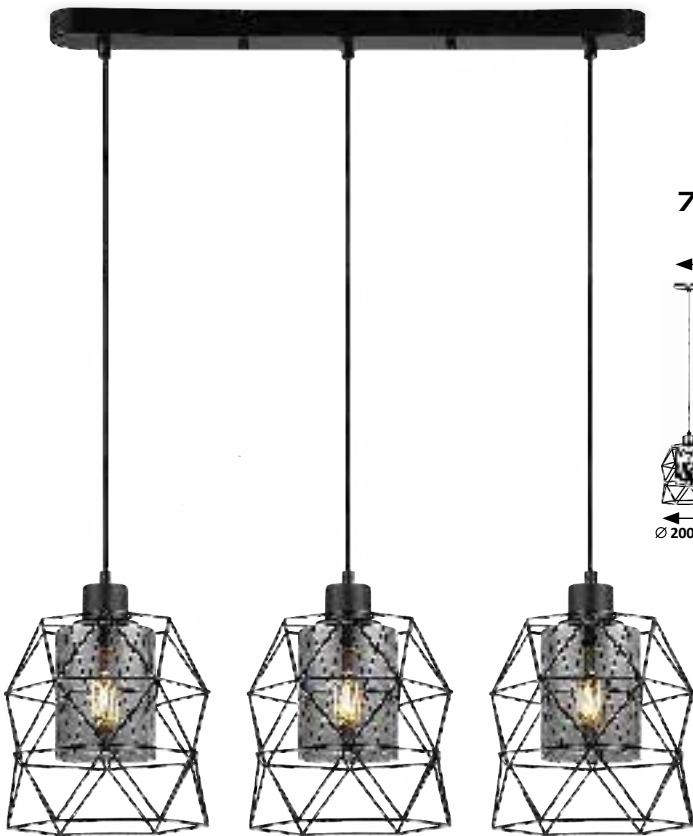
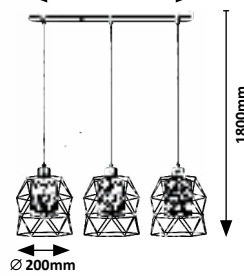

72111 **MG**

☒ E27 / 1x max. 40W
IP20 • 19965
matte black/tinted colour



= 476296 721114

72113 **MG**

☒ E27 / 3x max. 40W
IP20 • 19965
matte black/tinted colour



= 476296 721113



ASLAUG

TEXTILE
CABLE

New

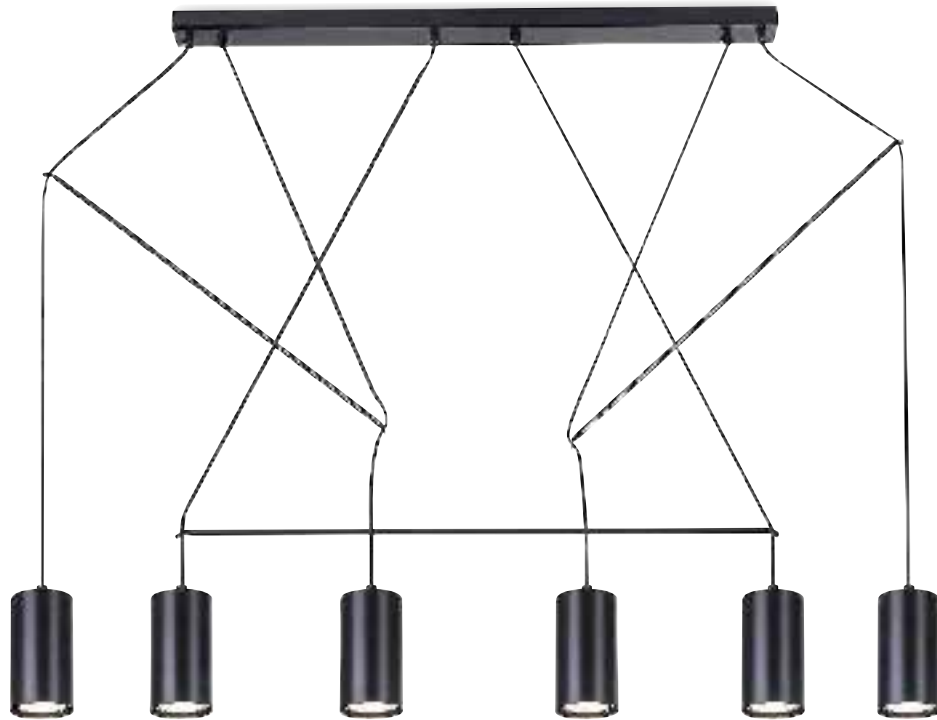

72018

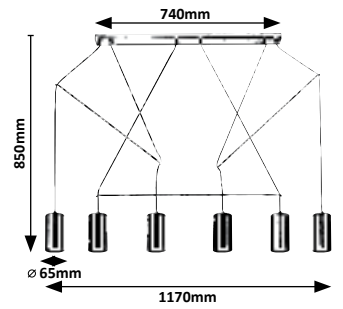

72018



☒ GU10 / 6x max. 50W
IP20
matte black



DILARA

TEXTILE
CABLE

1420
1586

New



72019

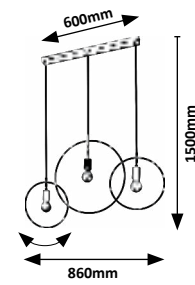

72019



☒ E27 / 3x max. 40W
IP20
matte black



CORTADO

HARLOW

TEXTILE
CABLE



5359

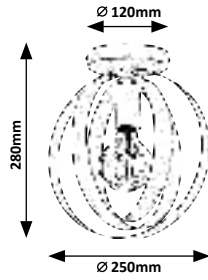

5361

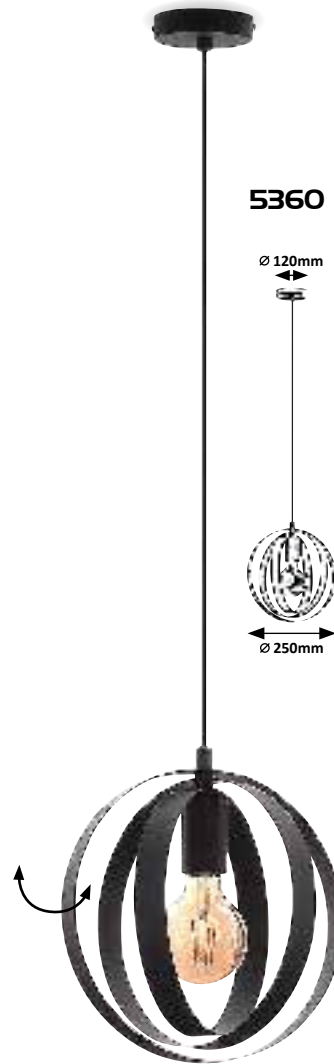
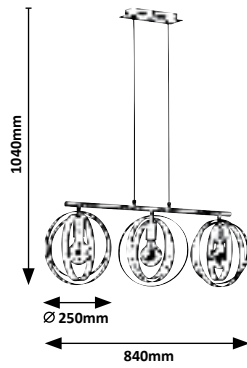

5360

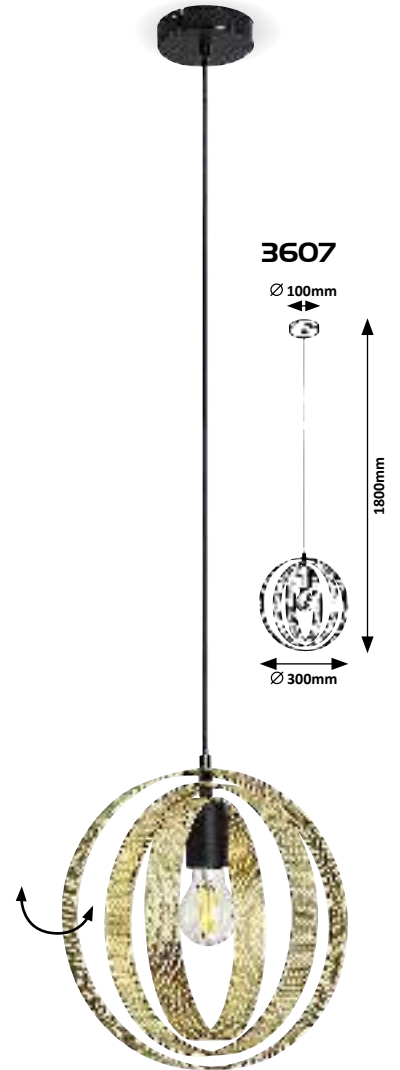
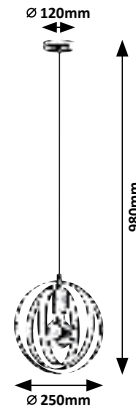

3607

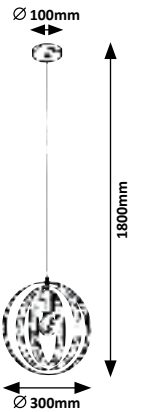

5359

(M)

☒ E27 / 1x max. 40W
IP20
black



5 362290 353593

5360

(M)

☒ E27 / 1x max. 40W
IP20
black



5 362290 353600

5361

(M)

☒ E27 / 3x max. 40W
IP20
black



5 362290 353610

3607

(M)

☒ E27 / 1x max. 60W
IP20
matte black/gold



5 408250 346077

CADMUS



71043

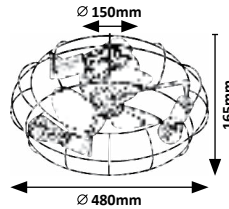

1x =	2x =
3x =	4x = OFF

71043 (M)

☒ E27 / 3x max. 35W
IP20 • 8-15m² • 20W
black



		1x
	RPM	1350
	dB	49,8



RAMSEY

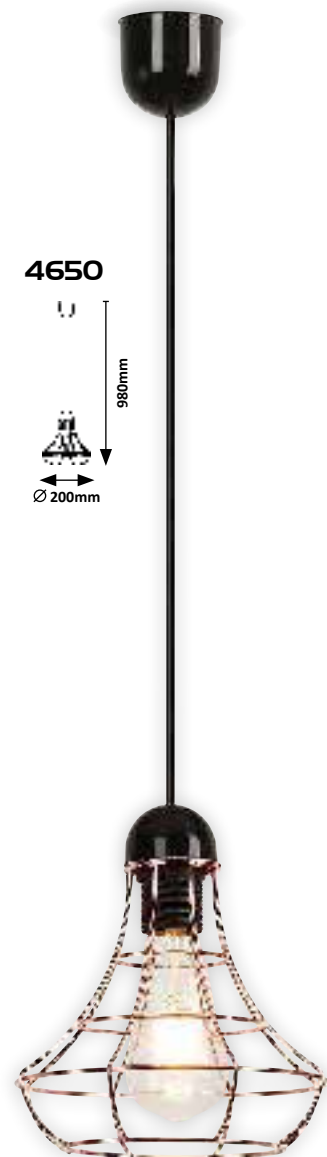
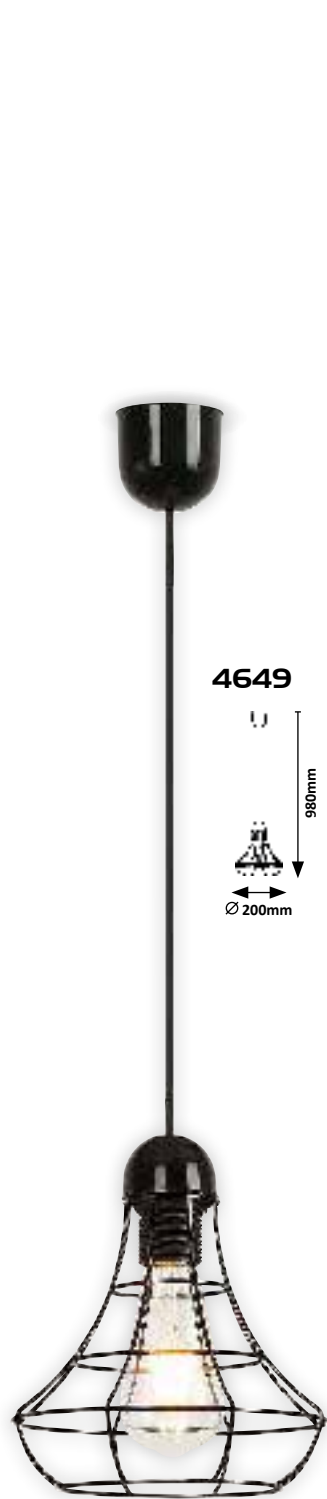

4649 (P) (M)

☒ E27 / 1x max. 60W
IP20 • 668
black



4650 (P) (M)

☒ E27 / 1x max. 60W
IP20 • 669
black/copper



— PAROV —

— ROWENA —

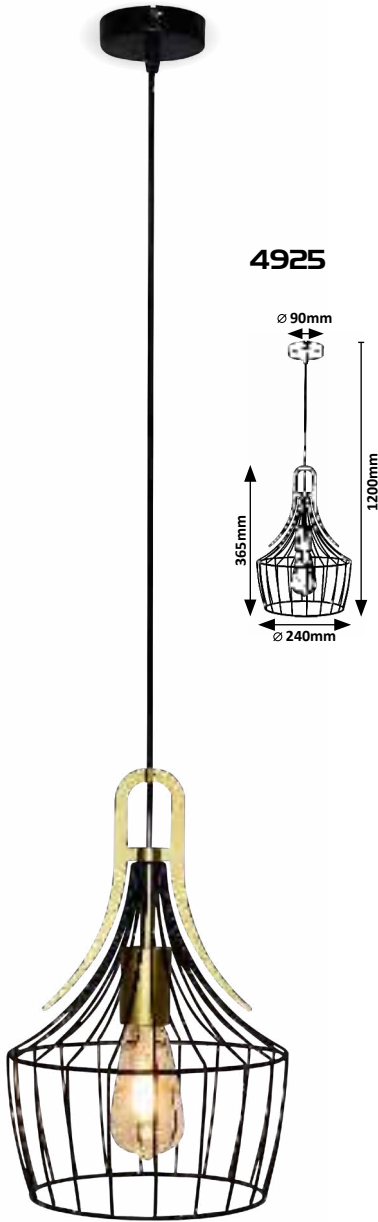

4925

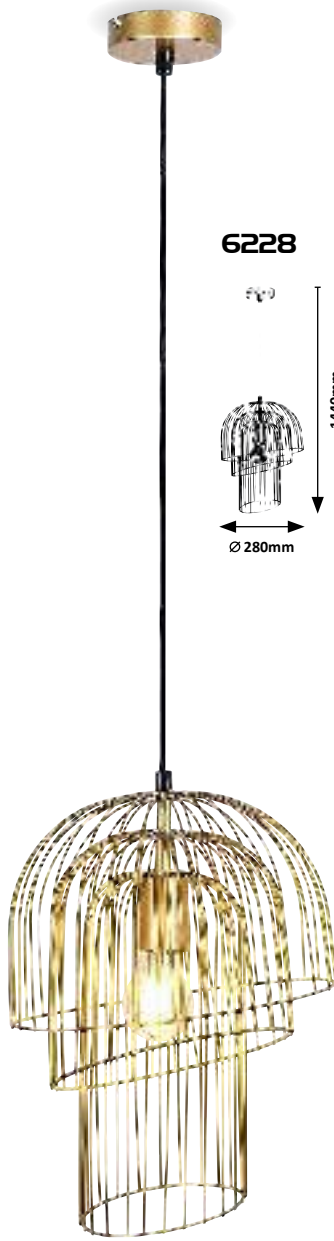
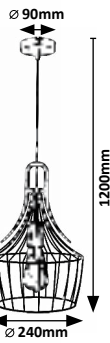

6228



4925 (M)

☒ E27 / 1x max. 40W
IP20
matte black/gold



6228 (M)

☒ E27 / 1x max. 60W
IP20
gold



SOMBERO



IDUNA

ZILLE



72004

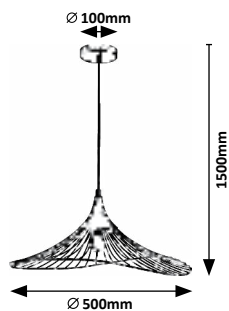

4347

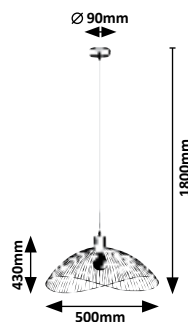

4754

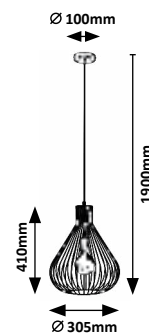

72004 (M)

☒ E27 / 1x max. 60W
IP20
matte black



4347 (M)

☒ E27 / 1x max. 60W
IP20
matte black



4754 (M)

☒ E27 / 1x max. 40W
IP20
red/matte black



RUPERT

WOOD

5238

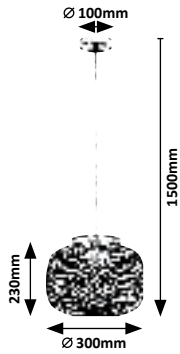

5237

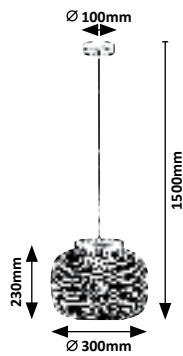

CALLIA

3020

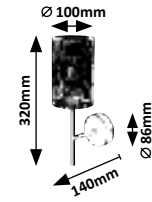

3018

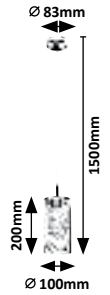

3019

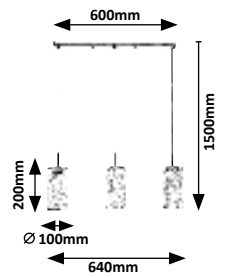

5237

(M) (W)

☒ E27 / 1x max. 40W
IP20
grey/beech



5238

(M) (W)

☒ E27 / 1x max. 40W
IP20
black/beech



3018

(M)

☒ E14 / 1x max. 25W
IP20
grey

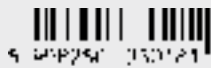

3019

(M)

☒ E14 / 3x max. 25W
IP20
grey



3020

(M)

☒ E14 / 1x max. 25W
IP20
grey



BELANO



3534 (M)
 ☒ E27 / 1x max. 40W
 IP20
 black



3535 (M)
 ☒ E27 / 2x max. 40W
 IP20
 black



3536 (M)
 ☒ E27 / 3x max. 40W
 IP20
 black



3537 (M)
 ☒ E27 / 4x max. 40W
 IP20
 black



3538 (M)
 ☒ E27 / 1x max. 40W
 IP20
 black

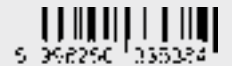

BELANO



3539

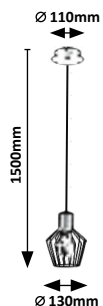

3540

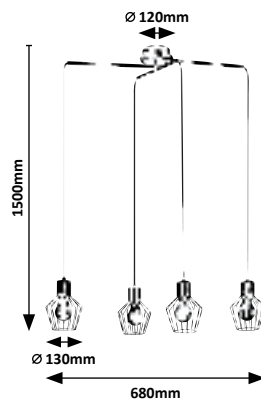

3539



☒ E27 / 1x max. 40W
IP20
black



S 39825C 335391

3540



☒ E27 / 4x max. 40W
IP20
black



S 39825C 335407



DIMITRI

TEXTILE
CABLE



3123 (M)

☒ E27 / 1x max. 40W
IP20
black



3124 (M)

☒ E27 / 1x max. 40W
IP20 •
black



DIMITRI

TEXTILE
CABLE

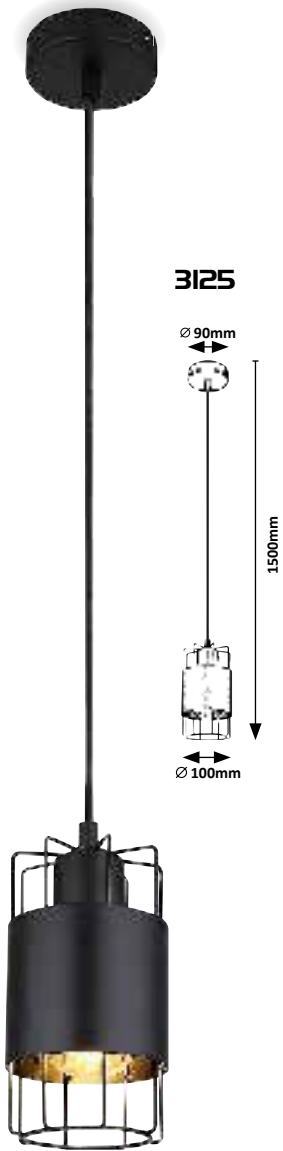

3125 (M)
☒ E27 / 1x max. 40W
IP20
black



3126 (M)
☒ E27 / 3x max. 40W
IP20
black



OBERON



5335

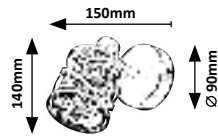

5336

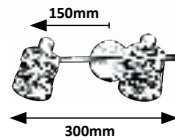

5337

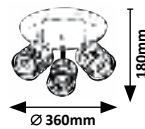

5338

TEXTILE
CABLE

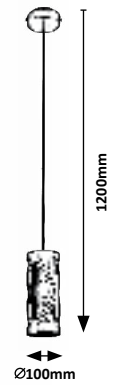

5335 **MG**

☒ E14 / 1x max. 40W
IP20 • 19830
brown/amber

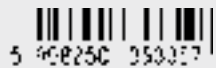

5336 **MG**

☒ E14 / 2x max. 40W
IP20 • 19830
brown/amber

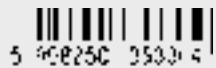

5337 **MG**

☒ E14 / 3x max. 40W
IP20 • 19830
brown/amber



5338 **MG**

☒ E14 / 1x max. 40W
IP20 • 19831
brown/amber



OBERON

TEXTILE
CABLE



5340

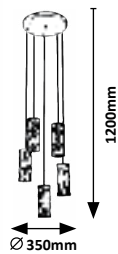

5339

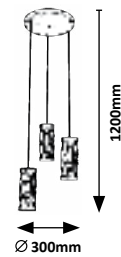

5339 **MG**

☒ E14 / 3x max. 40W
IP20 • 19831
brown/amber

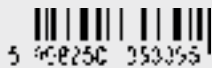

5340 **MG**

☒ E14 / 5x max. 40W
IP20 • 19831
brown/amber



GRENDEL

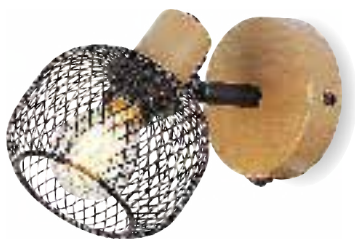

3127

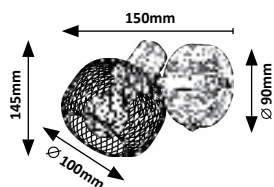

3128

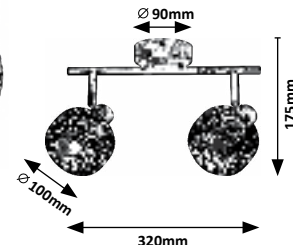

3129

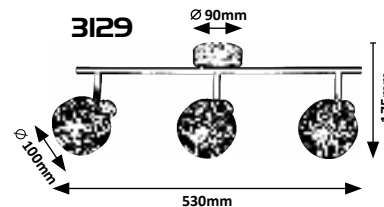

3130

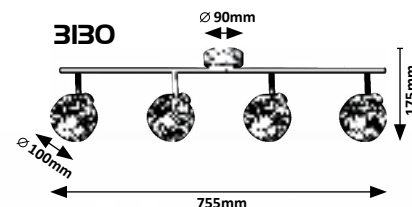

3127



⊠ E14 / 1x max. 40W
IP20 • beech/matte black



5 362260 33 270

3128



⊠ E14 / 2x max. 40W
IP20 beech/matte black



5 362260 33 287

3129



⊠ E14 / 3x max. 40W
IP20 beech/matte black



5 362260 33 294

3130



⊠ E14 / 4x max. 40W
IP20 beech/matte black



5 362260 33 300

GRENDEL

TEXTILE
CABLE



3131



☒ E27 / 1x max. 60W
IP20
beech/matte black



5 362250 33'3-7

3132



☒ E27 / 3x max. 60W
IP20
beech/matte black



5 362250 33'3-24





CALLUM

WOOD  **New**



74040

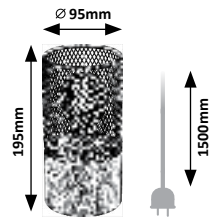

72041

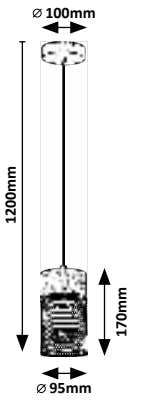

72043

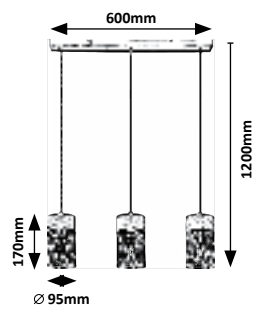

72041 

☒ E27 / 1x max. 25W
IP20
beech/black



72043 

☒ E27 / 3x max. 25W
IP20
beech/black



74040 

☒ E27 / 1x max. 25W
IP20 • 
beech/black



BRAULIA

WOOD

TEXTILE
CABLE

New



72131

∅ 100mm

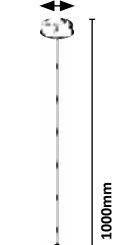

405mm

∅ 55mm



72133

610mm

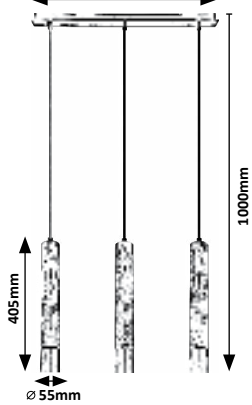

405mm

∅ 55mm



72131 **MW**

☒ GU10 / 1x max. 50W
IP20
beech/black



= 4 742 94 72131 7

72133 **MW**

☒ GU10 / 3x max. 50W
IP20
beech/black



= 4 742 94 72133 7

BOIRE

WOOD **New**



74006

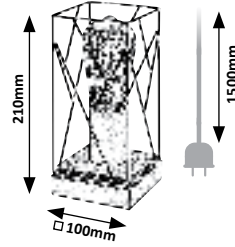

71021

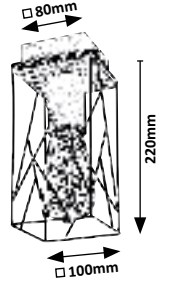

71023

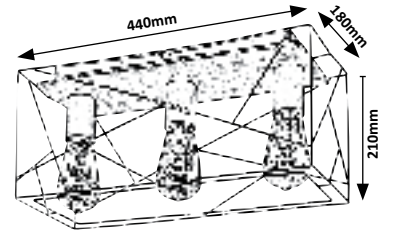

71024

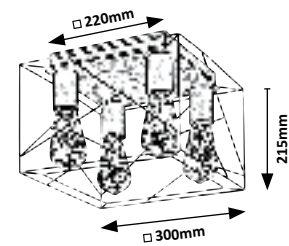

74006 (MW)

☒ E27 / 1x max. 40W
IP20 • black



71021 (MW)

☒ E27 / 1x max. 40W
IP20 black



71023 (MW)

☒ E27 / 3x max. 40W
IP20 black



71024 (MW)

☒ E27 / 4x max. 40W
IP20 black



BOROO

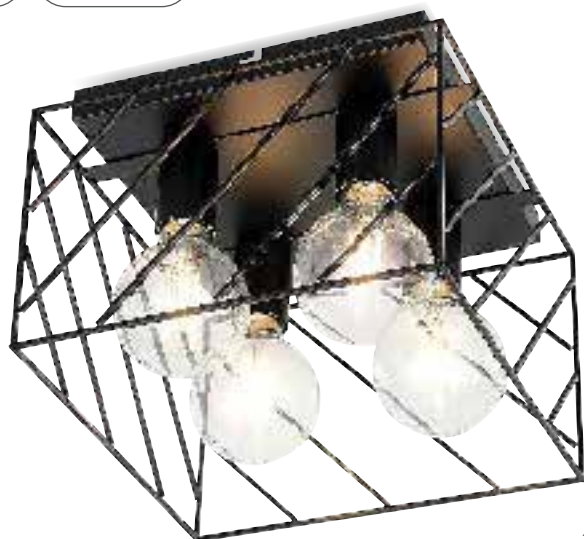

71027

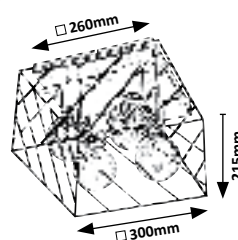

KAMALA

WOOD



5293

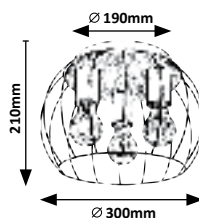

71027



☒ E27 / 4x max. 25W
IP20
matte black



4 746295 710270

5293



☒ E27 / 3x max. 25W
IP20
black/beechn



5 368260 752330





DARYL

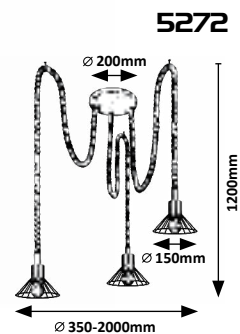
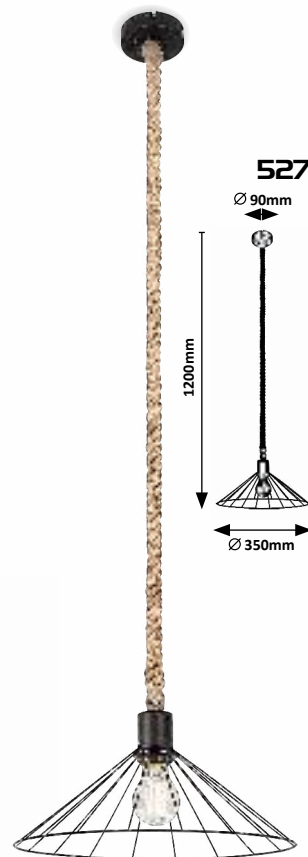
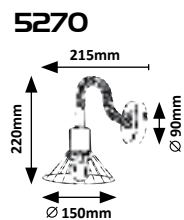

5270 (M)

☒ E27 / 1x max. 40W
IP20
black



5271 (M)

☒ E27 / 1x max. 40W
IP20
black



5272 (M)

☒ E27 / 3x max. 40W
IP20
black



FARFALLE

WOOD



New

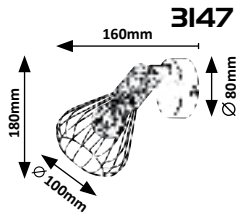
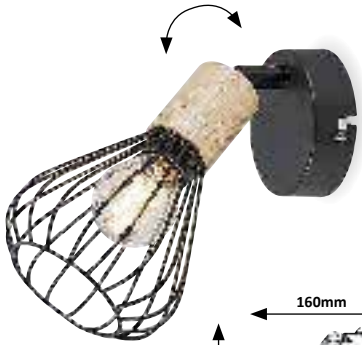

3150

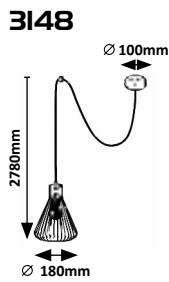
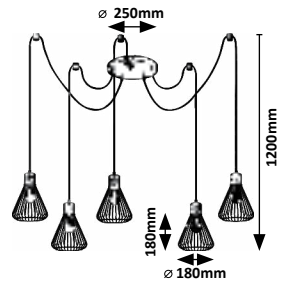

3148



3149

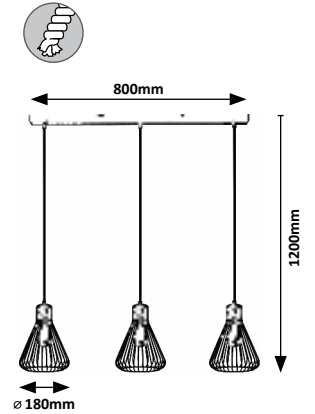

3147 (M) (W)

⊗ E14 / 1x max. 25W
IP20
black/beech



5 908253 31470

3149 (M) (W)

⊗ E27 / 3x max. 40W
IP20
black/beech



5 908253 31492

3148 (M) (W)

⊗ E27 / 1x max. 40W
IP20
black/beech



5 908253 31480

3150 (M) (W)

⊗ E27 / 5x max. 40W
IP20
black/beech



5 908253 31500



FABIAN

WOOD



5244

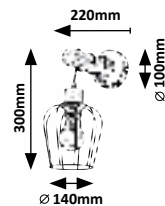

5245

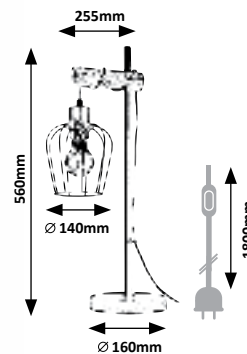

5244 (M) (W)

☒ E27 / 1x max. 40W
IP20 •
matte black/beechn



5245 (M) (W)

☒ E27 / 1x max. 40W
IP20 •
matte black/beechn



FABIAN

WOOD



5246

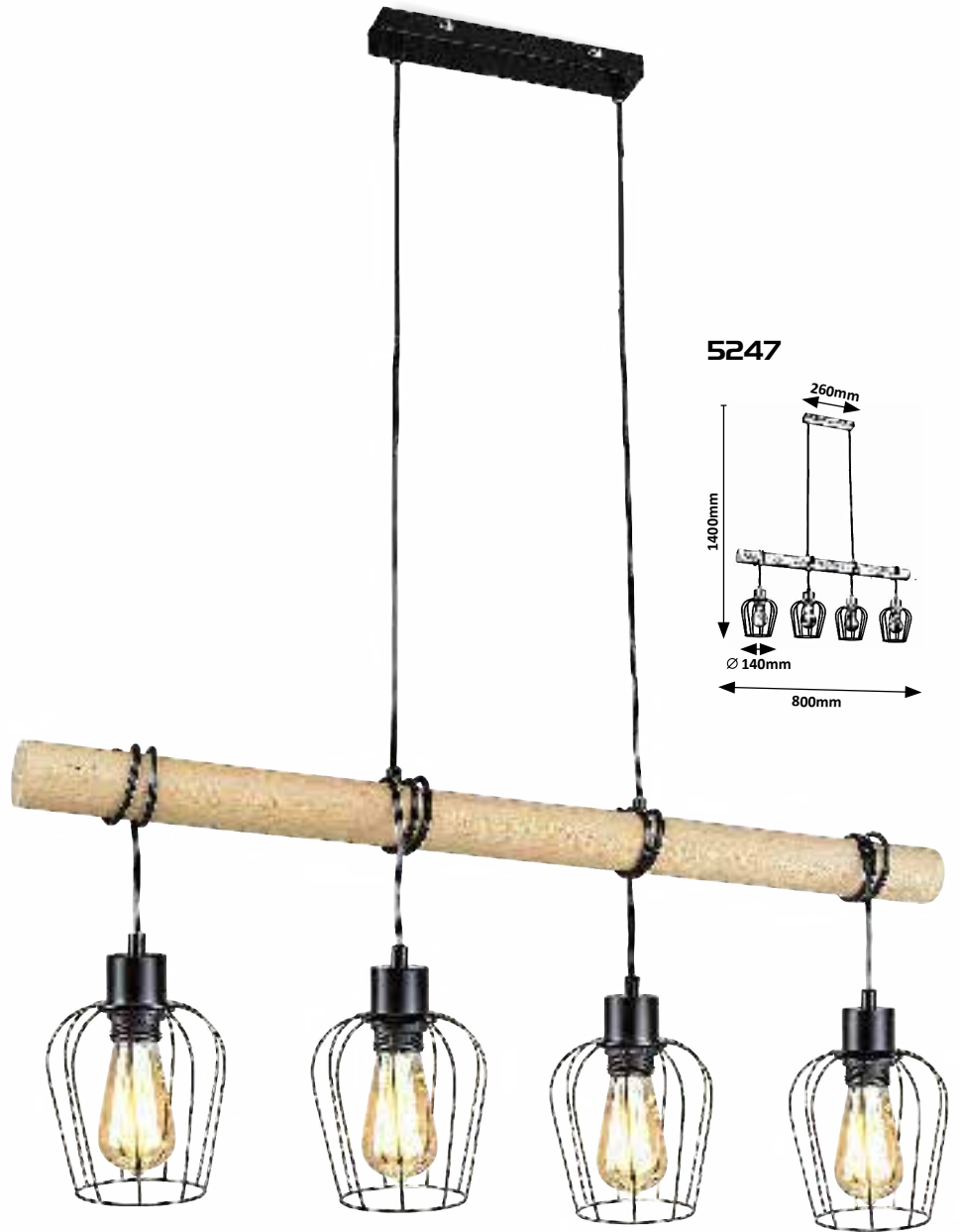
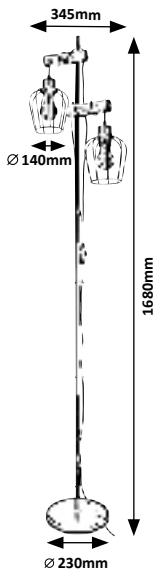

5247

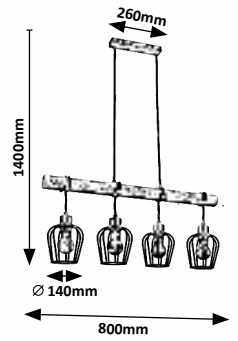

5246 (M) (W)

☒ E27 / 2x max. 40W
IP20 • 
matte black/beech



5247 (M) (W)

☒ E27 / 4x max. 40W
IP20
matte black/beech



INDIANA

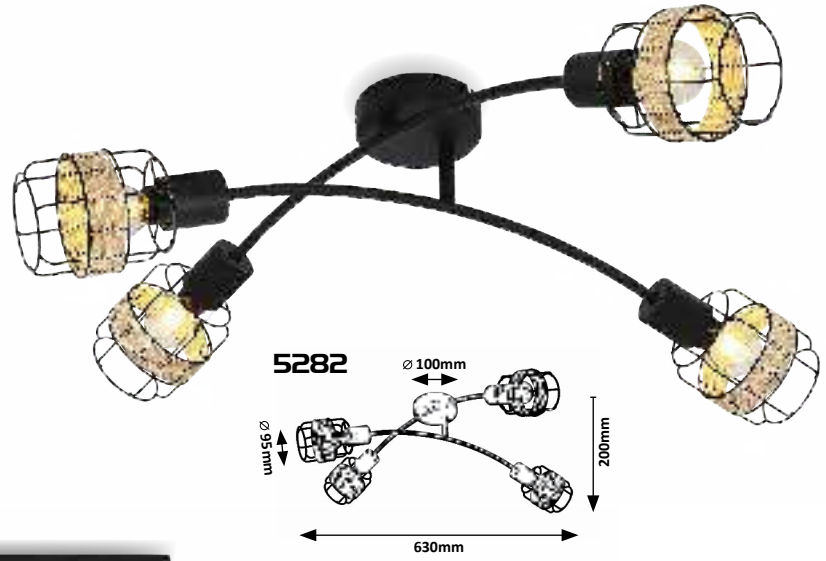
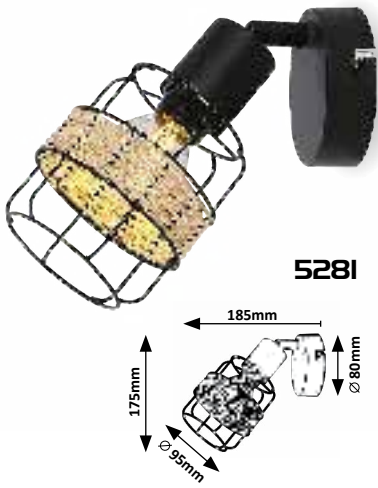

5281 (M)

☒ E14 / 1x max. 25W
IP20
matte black/natural



5282 (M)

☒ E14 / 4x max. 25W
IP20
matte black/natural



5284 (M)

☒ E14 / 4x max. 25W
IP20
matte black/natural



INDIANA



5283

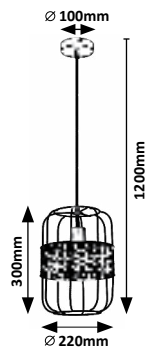

5283



☒ E27 / 1x max. 40W
IP20
matte black/natural



ADALLA

New



71091

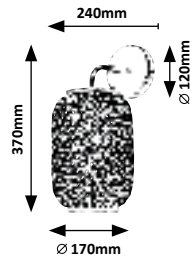

72091

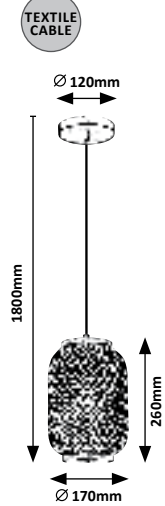

72093

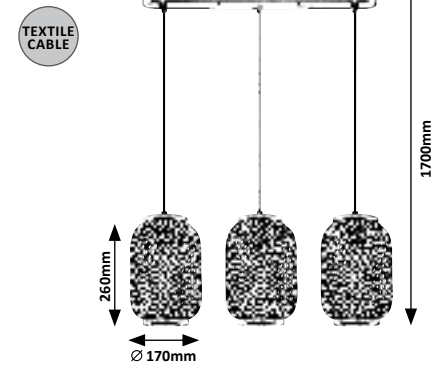

71091 (M) (Ra)

☒ E27 / 1x max. 40W
IP20
matte black/multicolour



72091 (M) (Ra)

☒ E27 / 1x max. 40W
IP20
matte black/multicolour



72093 (M) (Ra)

☒ E27 / 3x max. 40W
IP20
matte black/multicolour



ALINAFE

ZAHARA

WOOD

New



74016

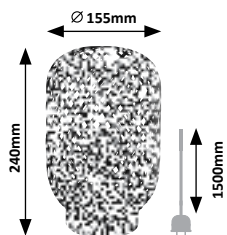

7604

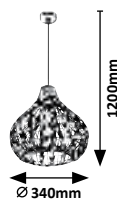

74016 (M) (W) (Ra)

⊗ E14 / 1x max. 25W
IP20
natural



4 74016 740160

7604 (M) (Ra)

⊗ E27 / 1x max. 40W
IP20
natural



5 362250 375232

RATTAN

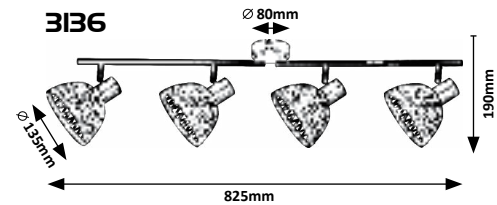
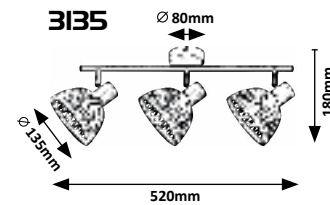
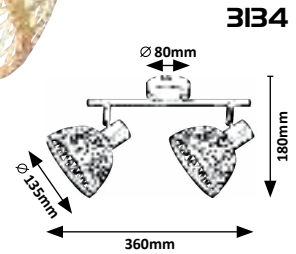
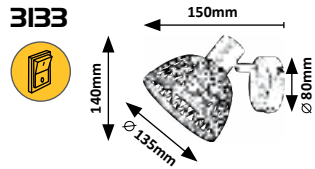

3133 (M) (RA)

☒ E14 / 1x max. 15W
IP20 • 19835
matte black/natural

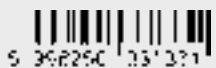

3134 (M) (RA)

☒ E14 / 2x max. 15W
IP20 • 19835
matte black/natural



3135 (M) (RA)

☒ E14 / 3x max. 15W
IP20 • 19835
matte black/natural



3136 (M) (RA)

☒ E14 / 4x max. 15W
IP20 • 19835
matte black/natural



RATTAN

✦ New



71025

WOOD

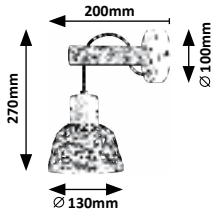

72025

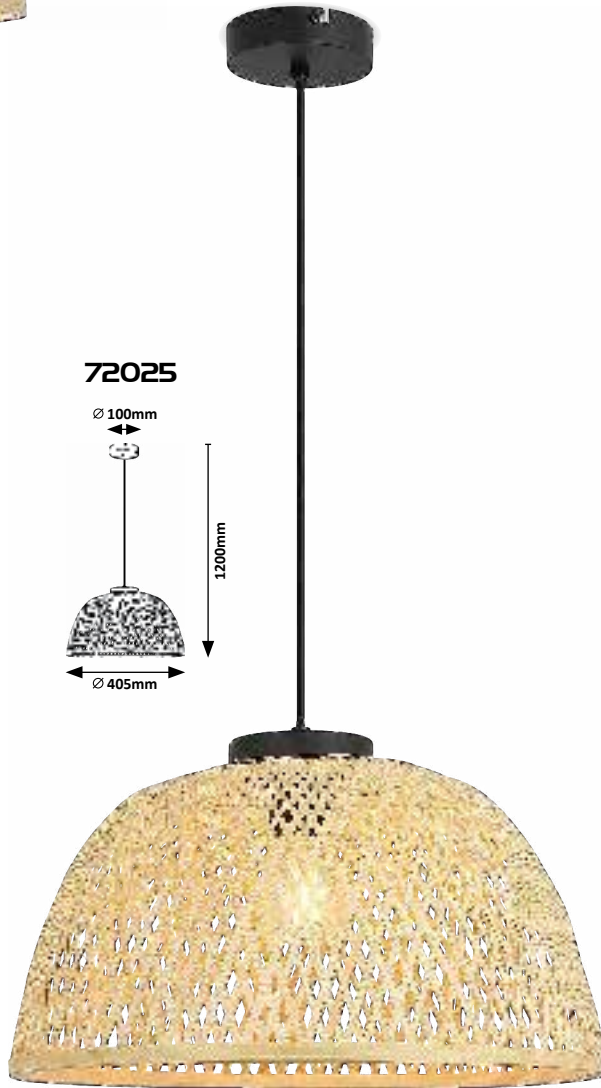
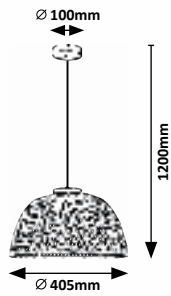

ORMINI

✦ New

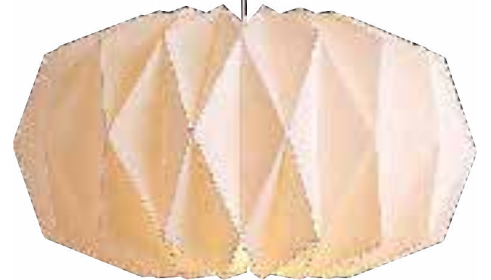

72003

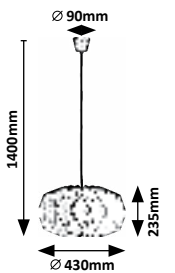

71025 M Ra W

☒ E27 / 1x max. 15W
IP20 • 19835
black/natural



72025 M Ra

☒ E27 / 1x max. 25W
IP20 • 70023
black/natural



72003 M PA

☒ E27 / 1x max. 25W
IP20
matte white



UBUL

WOOD TEXTILE CABLE  **New**

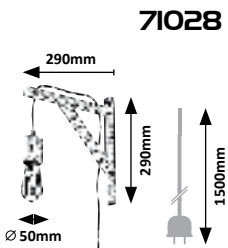

71028

71028 
 ☒ E27 / 1x max. 60W
 IP20 • 
 beech



INDIGO

WOOD  **New**

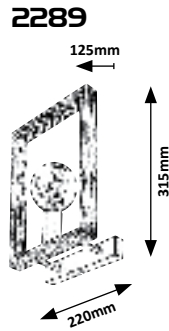

2289

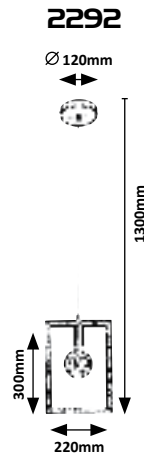
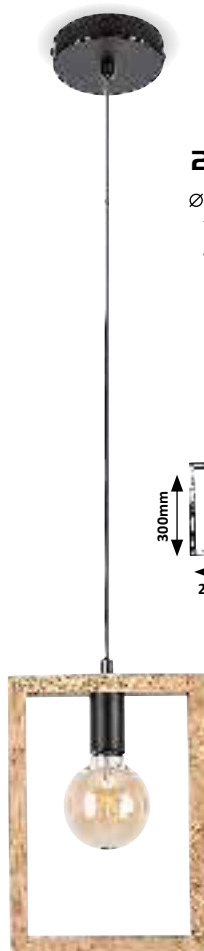

2292

Ø 120mm



300mm

220mm

1300mm

2289  
 ☒ E27 / 1x max. 40W
 IP20
 black/beech

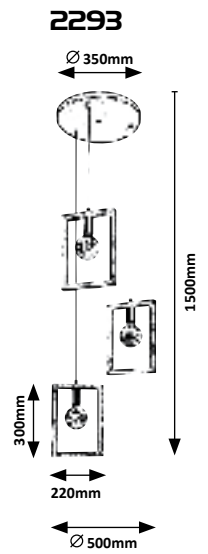

2293

Ø 350mm



300mm

220mm

1500mm

Ø 500mm

2293  
 ☒ E27 / 3x max. 40W
 IP20
 black/beech



INDIGO

WOOD

New

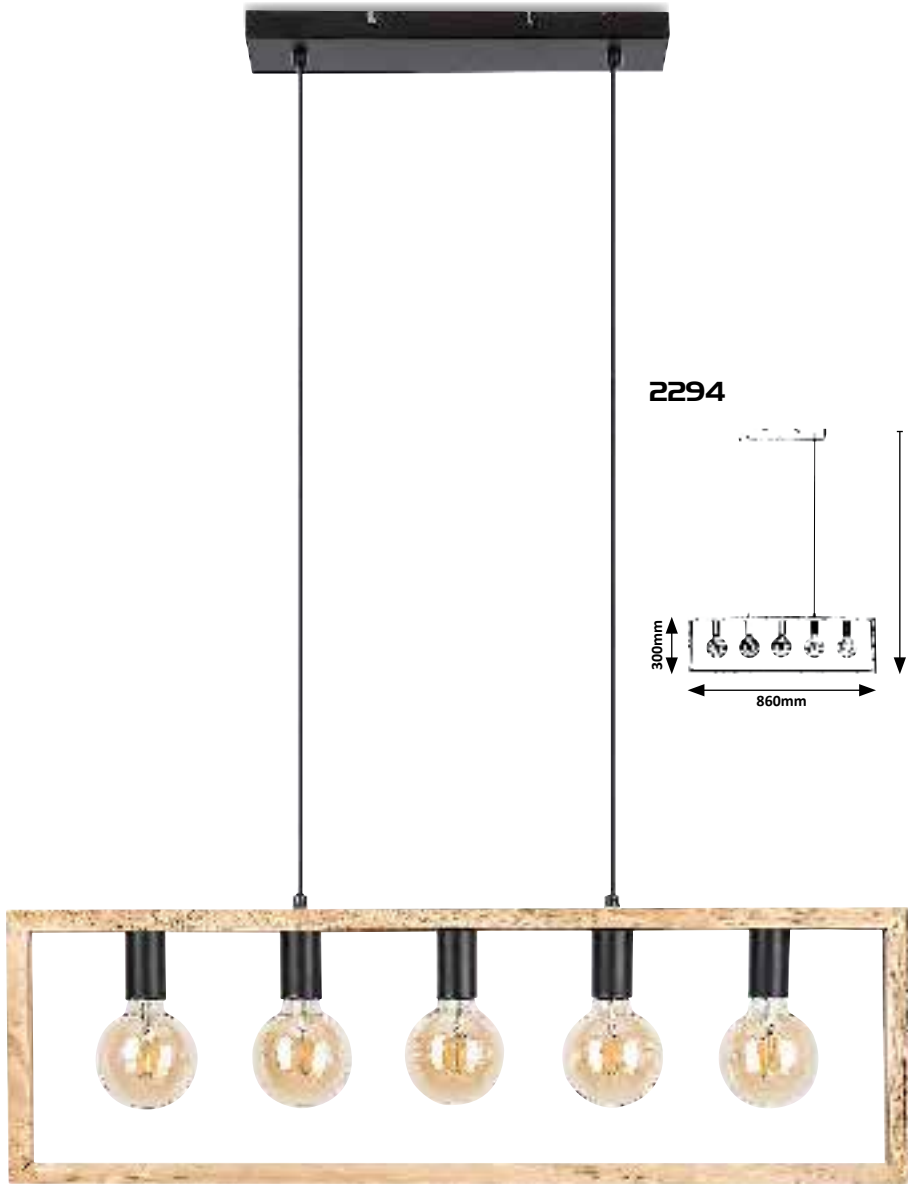

2294

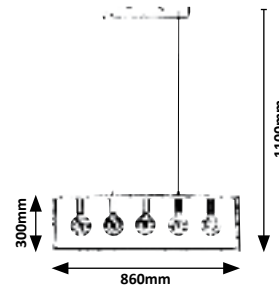

2294 (M) (W)

☒ E27 / 5x max. 40W
IP20
black/beech



PABLO

WOOD

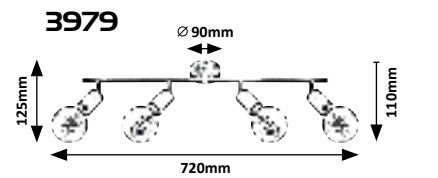
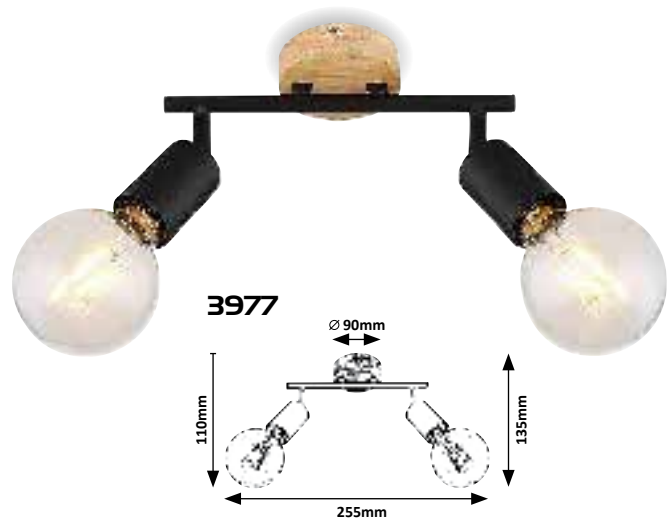

3976 (M) (W)
 ☒ E27 / 1x max. 40W
 IP20
 matte black/beechn



3977 (M) (W)
 ☒ E27 / 2x max. 40W
 IP20
 matte black/beechn



3978 (M) (W)
 ☒ E27 / 3x max. 40W
 IP20
 matte black/beechn



3979 (M) (W)
 ☒ E27 / 4x max. 40W
 IP20
 matte black/beechn



PABLO

WOOD



3980

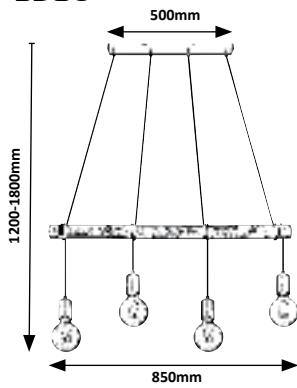

3980 **M** **W**

☒ E27 / 4x max. 40W
IP20
matte black/beech



DOLLIEN

✦ | **New**

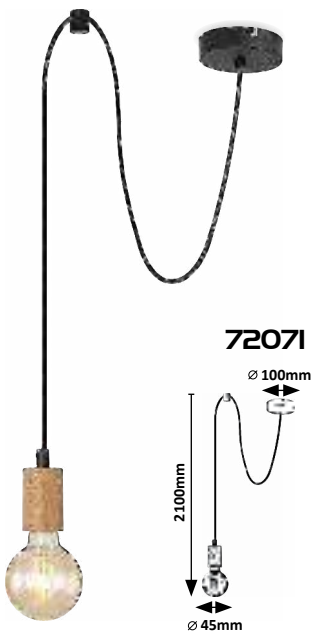

72071 (M)

☒ E27 / 1x max. 60W
IP20
matte black/beechn



72075 (M)

☒ E27 / 5x max. 60W
IP20
matte black/beechn



BRANWEN

ZURIEL

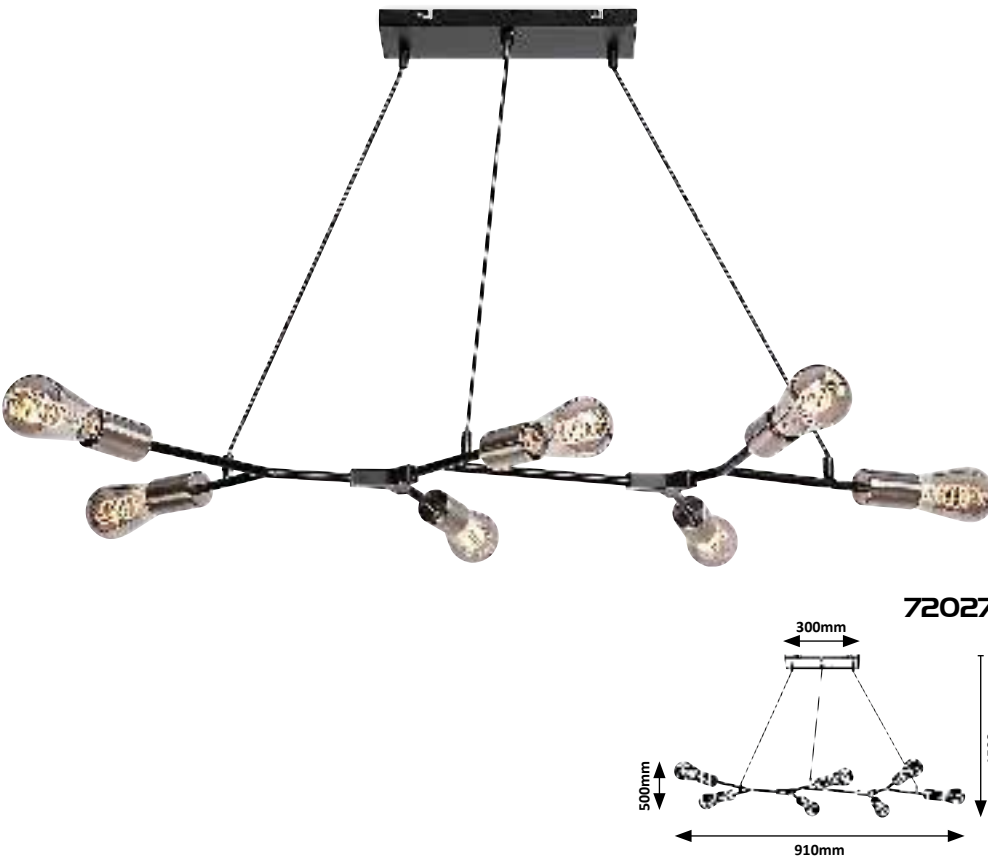
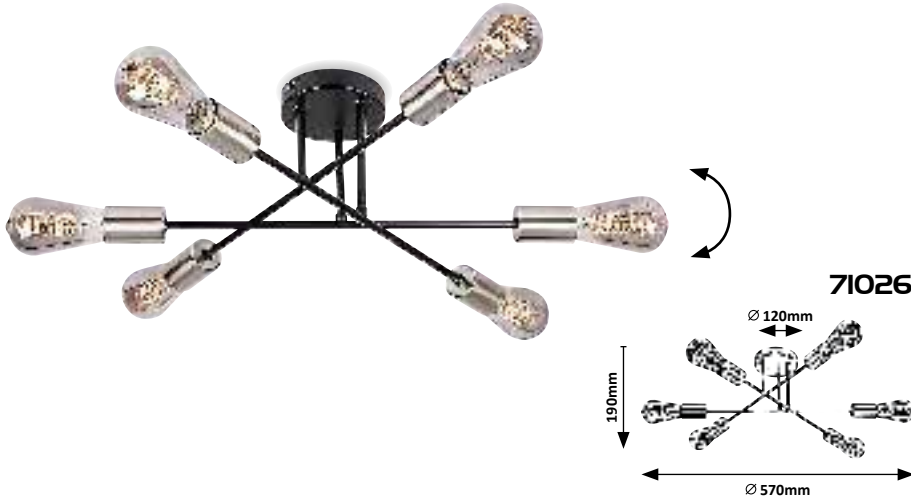
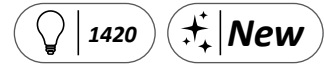

71026 **(M)**
 ☒ E27 / 6x max. 25W
 IP20
 matte black/satin chrome



72027 **(M)**
 ☒ E27 / 7x max. 25W
 IP20
 matte black/satin chrome



72015 **(M)**
 ☒ E27 / 1x max. 40W
 IP20
 satin chrome





LAMAR

Others /
415. Best match

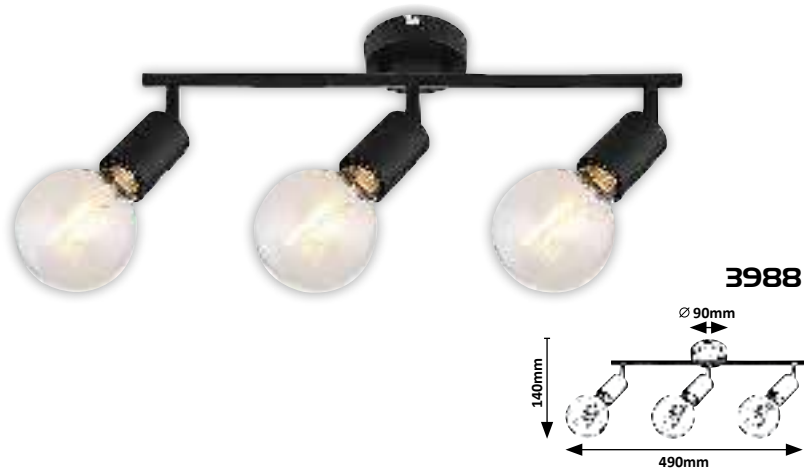

3986 (M)

☒ E27 / 1x max. 40W
IP20
matte black



3987 (M)

☒ E27 / 2x max. 40W
IP20
matte black



3988 (M)

☒ E27 / 3x max. 40W
IP20
matte black



LAMAR

Others /
415. Best match

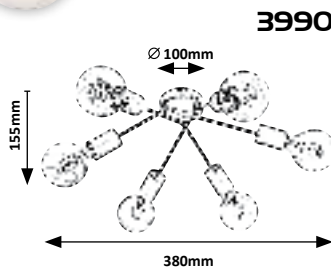
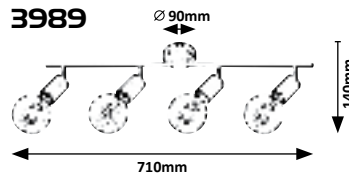

3989 (M)
E27 / 4x max. 40W
IP20
matte black



3990 (M)
E27 / 6x max. 40W
IP20
matte black





CASPAR



2224

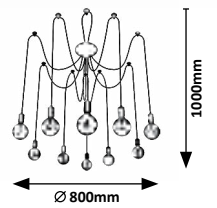

2224



☒ E27 / 10x max. 60W
IP20
matte black



ALMUS

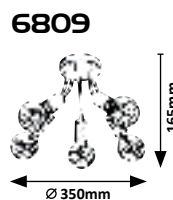
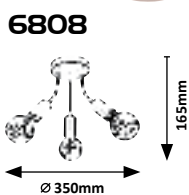

MANZUR

New

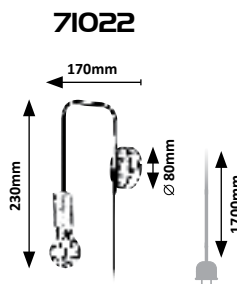

6808 (M)
 E27 / 3x max. 60W
 IP20
 black



6809 (M)
 E27 / 5x max. 60W
 IP20
 black



71022 (M)
 E27 / 1x max. 40W
 IP20 •
 black



FIDEL

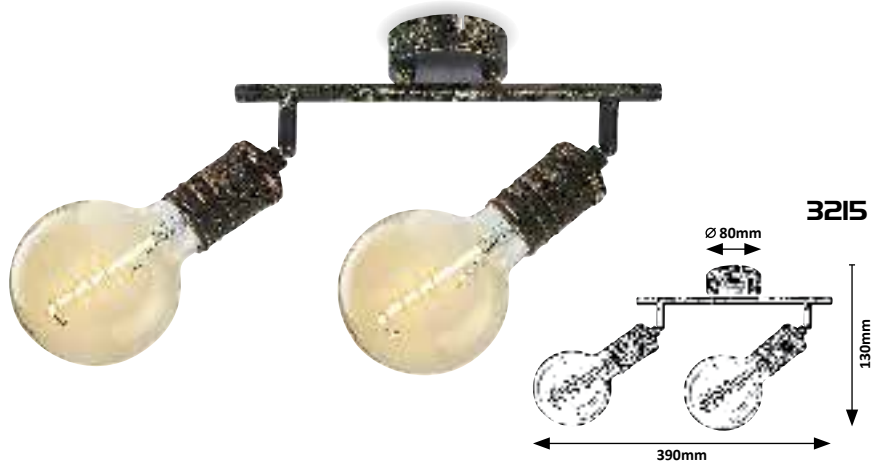

3214 (M)

☒ E27 / 1x max. 25W
IP20
antique gold



3215 (M)

☒ E27 / 2x max. 25W
IP20
antique gold



3216 (M)

☒ E27 / 3x max. 25W
IP20
antique gold



3217 (M)

☒ E27 / 4x max. 25W
IP20
antique gold



FIDEL



3218

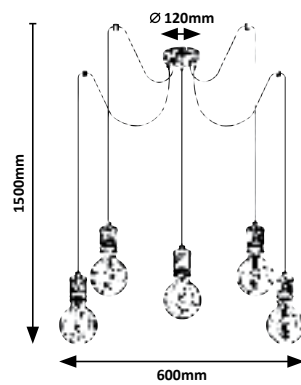

3218 (M)

☒ E27 / 5x max. 25W
IP20
antique gold



LANNY



2102

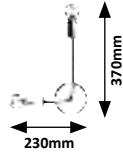

2103

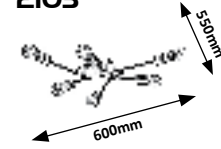

2116

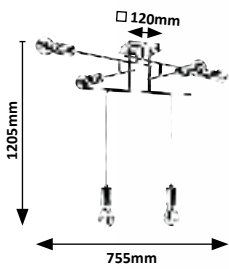

2104

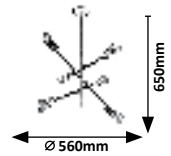

2102



☒ E27 / 2x max. 15W
IP20
black/gold



5 362250 321026

2103



☒ E27 / 6x max. 15W
IP20
black/gold



5 362250 321035

2104



☒ E27 / 6x max. 15W
IP20
black/gold



5 362250 321042

2116



☒ E27 / 6x max. 40W
IP20
black/gold



5 362250 321114

LANNY



4560

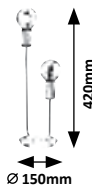

4561



4560 

☒ E27 / 2x max. 15W
IP20 • 
black/gold



4561 

☒ E27 / 4x max. 15W
IP20 • 
black/gold



2116



SEPARATELY
SWITCHABLE



ALVARO



3157

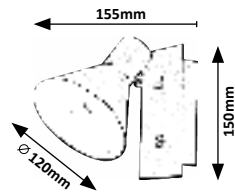

3158

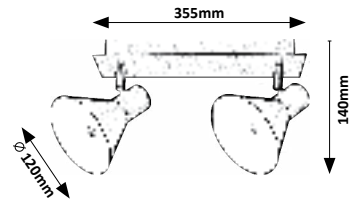

3157



⊗ E14 / 1x max. 40W
IP20 • 
matte black/gold/white



3158



⊗ E14 / 2x max. 40W
IP20
matte black/gold/white



ALVARO

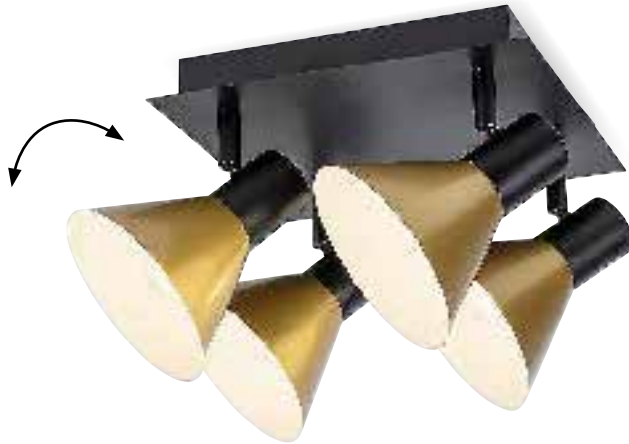

3159

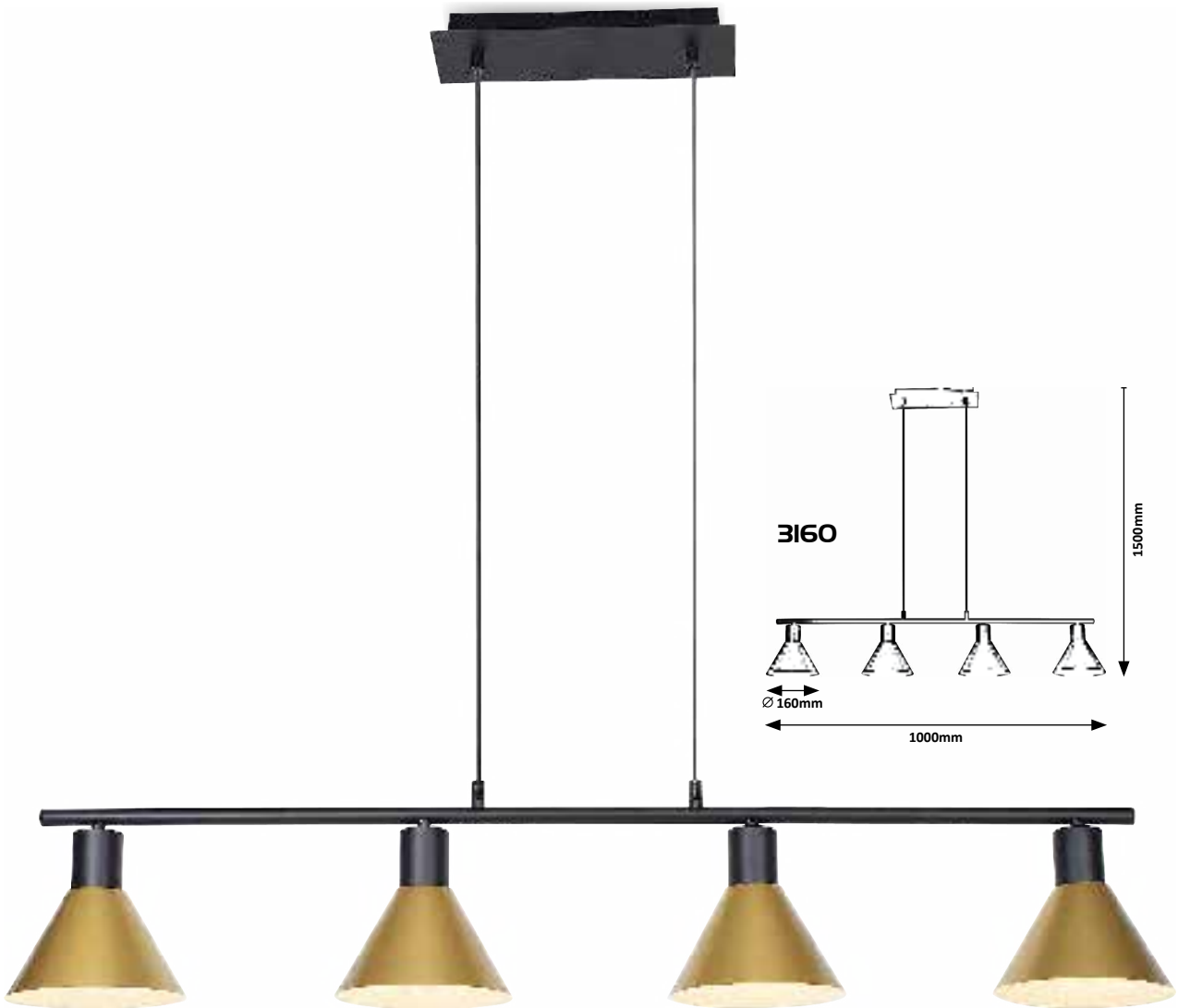
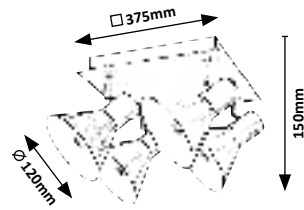

3160

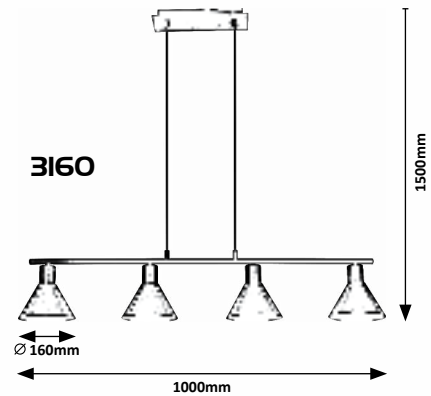

3159



☒ E14 / 4x max. 40W
IP20
matte black/gold/white



S 36R25C 33'591

3160



☒ E27 / 4x max. 40W
IP20
matte black/gold/white



S 36R25C 33'207



ROTEM

WOOD

TEXTILE
CABLE

designed by
rabalux



3298

190mm

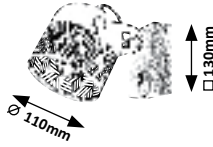

3299

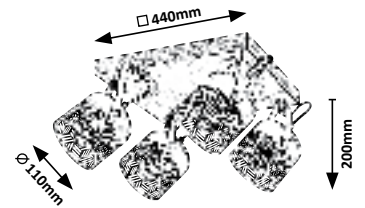

3300

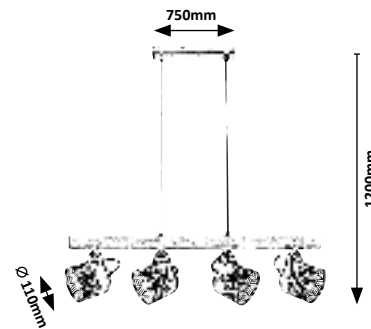

3298 (M) (W)

⊗ E14 / 1x max. 40W
IP20 • □
walnut/matte black



5 362260 332387

3299 (M) (W)

⊗ E14 / 4x max. 40W
IP20
walnut/matte black



5 362260 332394

3300 (M) (W)

⊗ E14 / 4x max. 40W
IP20
walnut/matte black



5 362260 332307



AKSEL

WOOD



2723

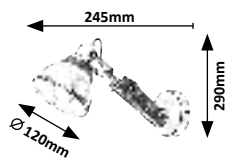

4199

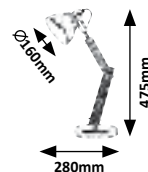

2724

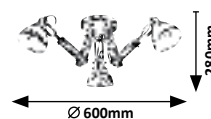

2723 (M) (W)

☒ E14 / 1x max. 25W
IP20
anthracite/beech



2724 (M) (W)

☒ E14 / 3x max. 15W
IP20
anthracite/beech



4199 (M) (W)

☒ E14 / 1x max. 15W
IP20 • ☐
anthracite/beech



KYLE

DOUG

TEXTILE
CABLE

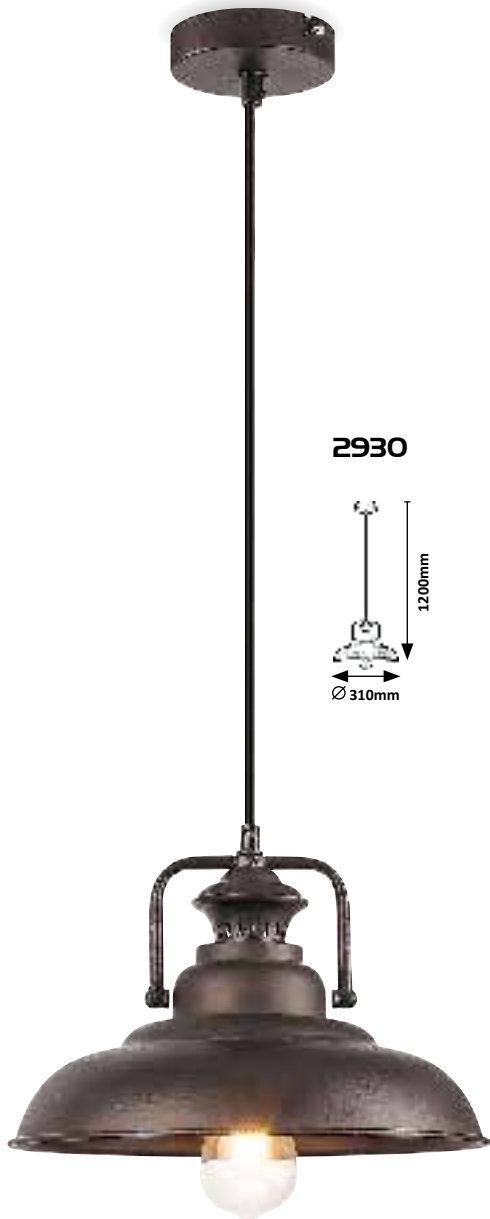

2930

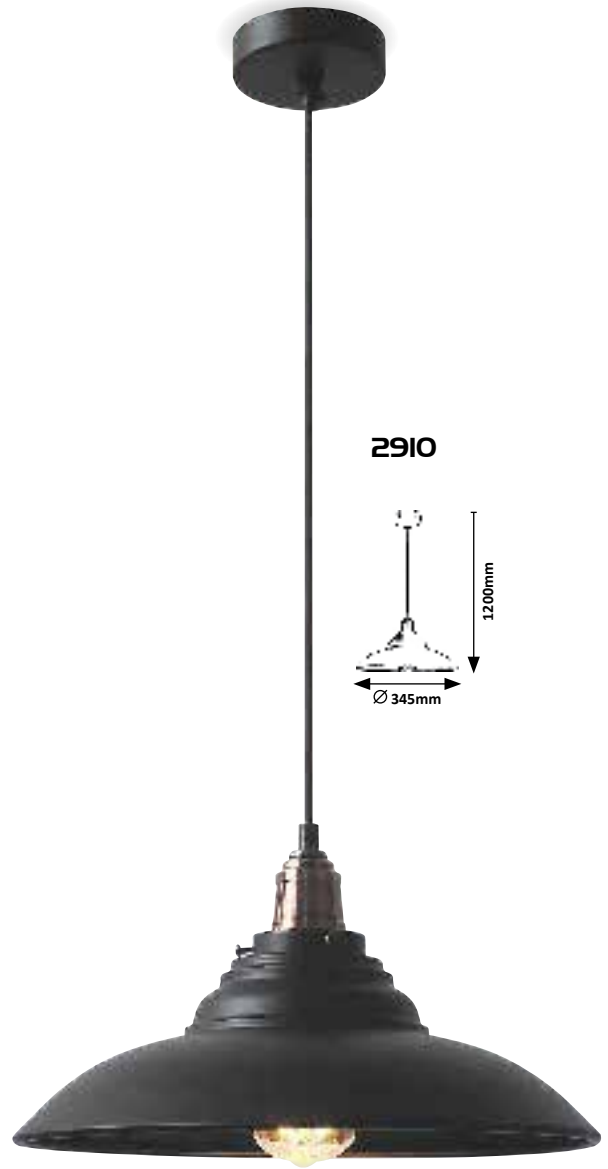
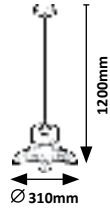

2910

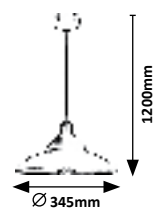

2930



☒ E27 / 1x max. 60W
IP20
brown



2910



☒ E27 / 1x max. 60W
IP20
matte black

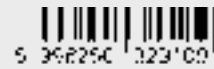

DRAGAN



5307

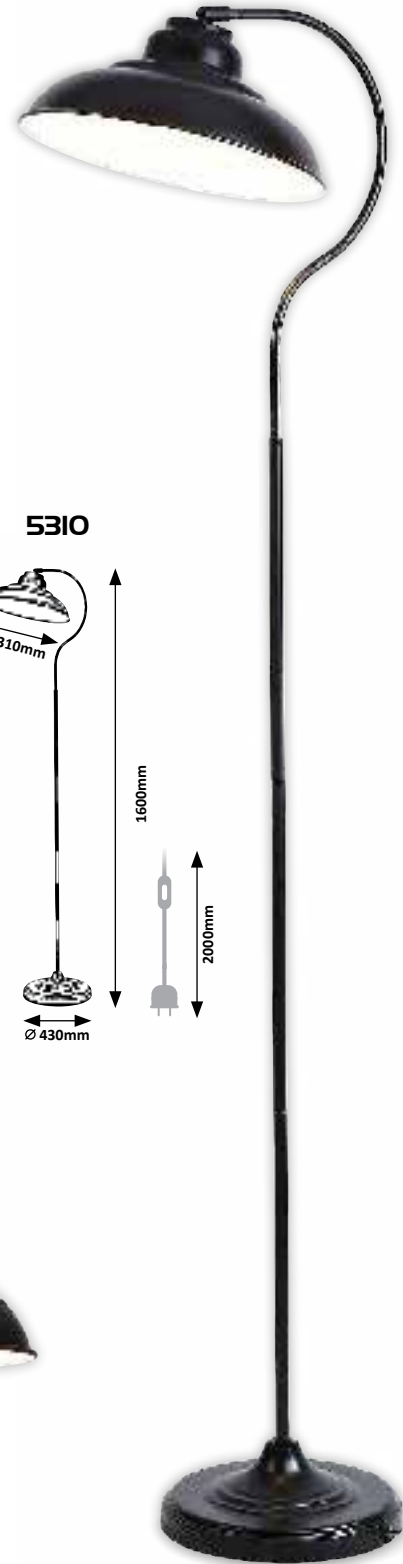
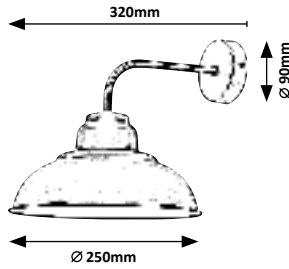

5310

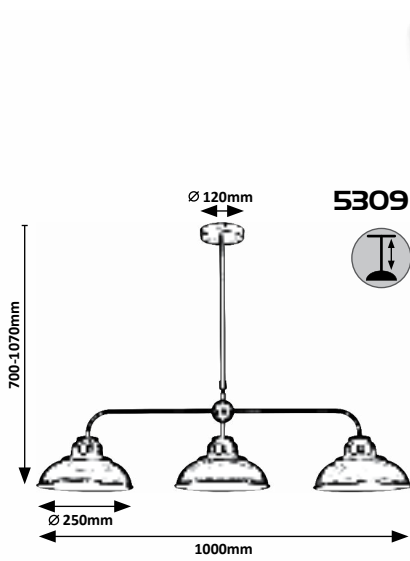
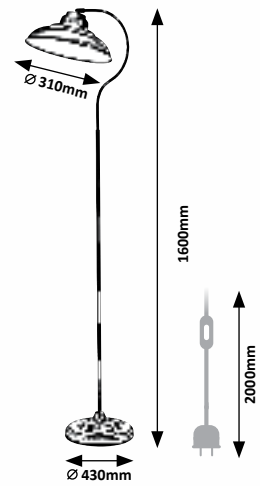

5309



5307



☒ E27 / 1x max. 60W
IP20
matte black/white



5 398290 053074

5309



☒ E27 / 3x max. 60W
IP20
matte black/white



5 398290 053098

5310



☒ E27 / 1x max. 60W
IP20 • ☐
matte black/white



5 398290 053104

DRAGAN

TEXTILE
CABLE

5308

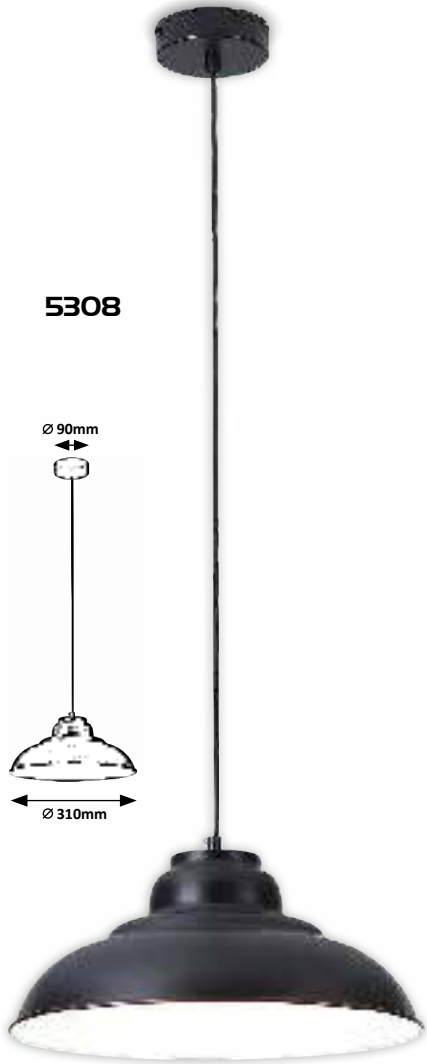
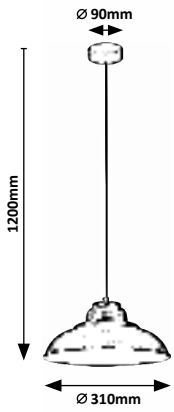

5308



☒ E27 / 1x max. 60W
IP20
matte black/white



MALIA



3094

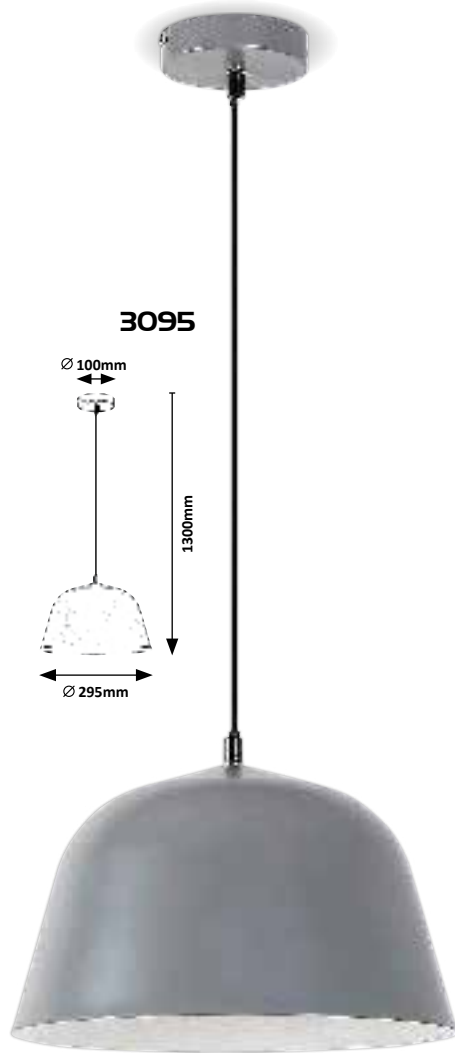
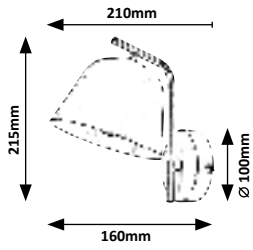

3095

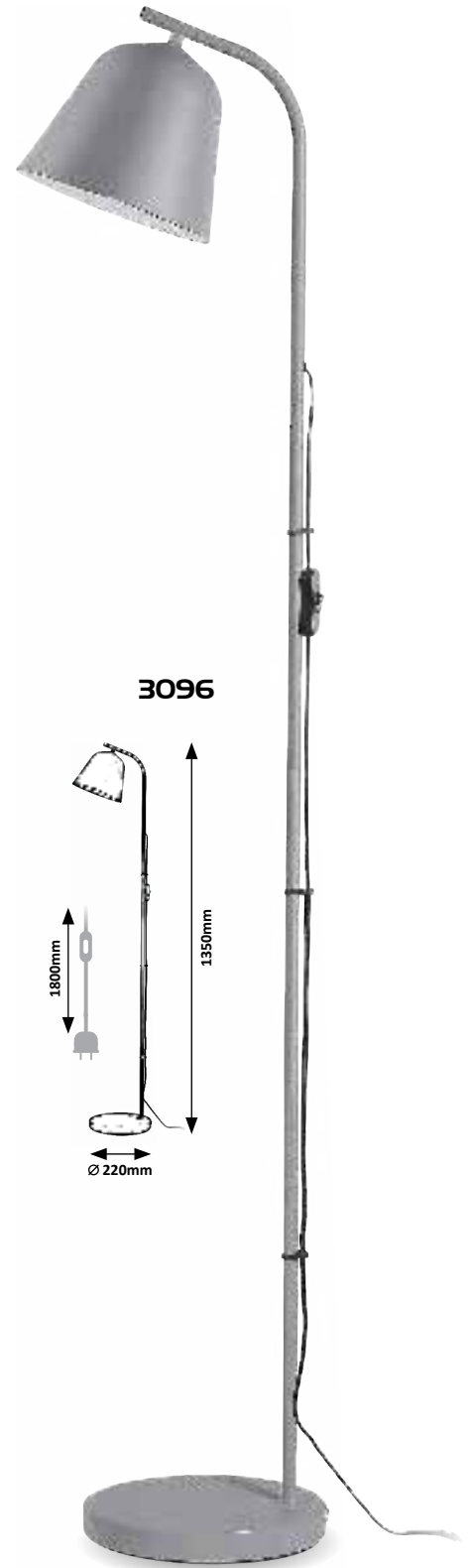
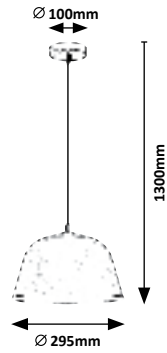

3096

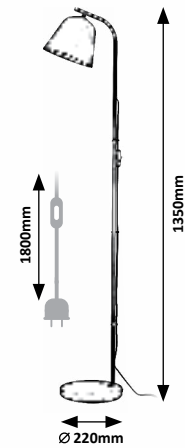

3094 (M)

☒ E14 / 1x max. 25W
IP20
grey/white



3095 (M)

☒ E27 / 1x max. 60W
IP20
grey/white



3096 (M)

☒ E27 / 1x max. 25W
IP20 • ☒
grey/white



DEREK

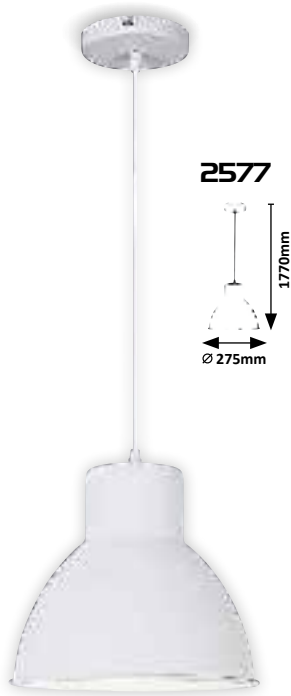

2577

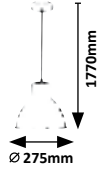

2579

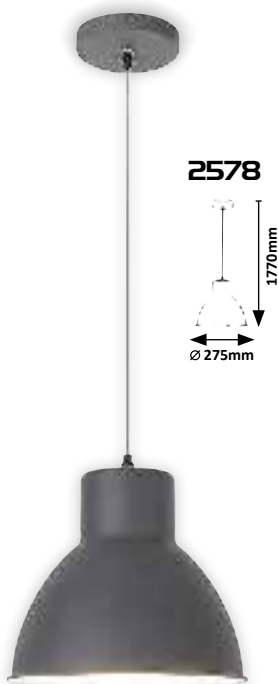
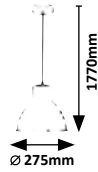

2578

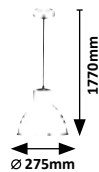

4328

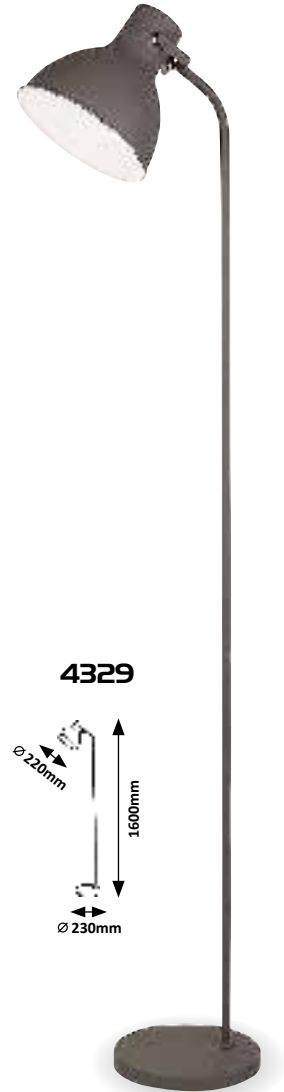
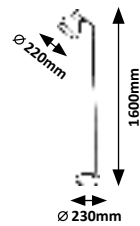

4329

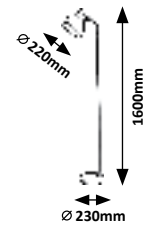

2577



☒ E27 / 1x max. 60W
IP20
matte white



S 36R29C 325774

2578



☒ E27 / 1x max. 60W
IP20
anthracite



S 36R29C 325781

2579



☒ E27 / 1x max. 60W
IP20
silver



S 36R29C 325798

4328



☒ E27 / 1x max. 25W
IP20 • ☒
white



S 36R29C 343280

4329



☒ E27 / 1x max. 25W
IP20 • ☒
grey



S 36R29C 343297



WILBOUR

New

72013

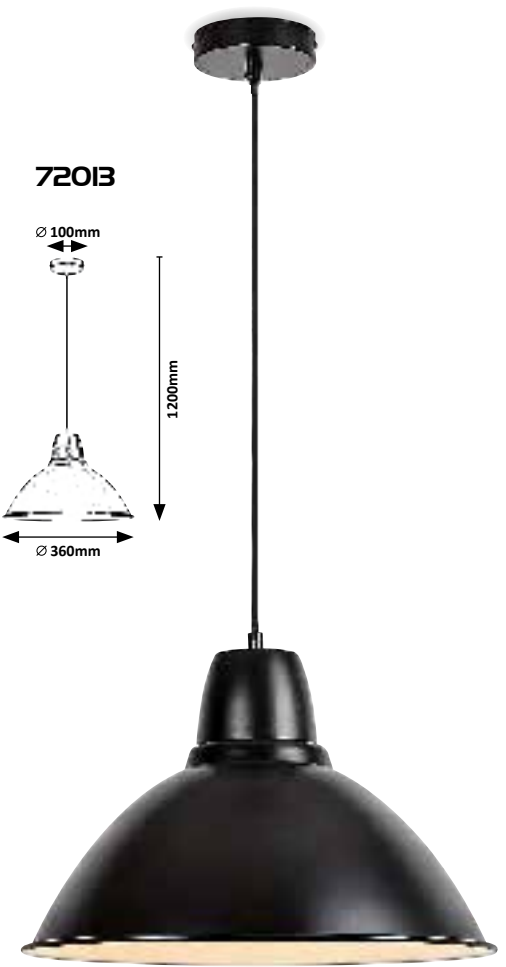
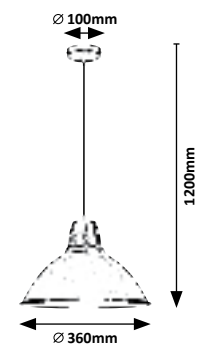

72014

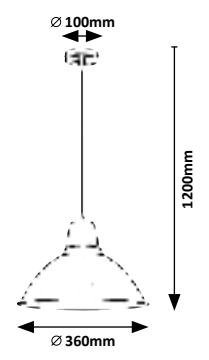

72013 **(M)**

☒ E27 / 1x max. 60W
IP20
black/white



72014 **(M)**

☒ E27 / 1x max. 60W
IP20
white



FELIPE

New

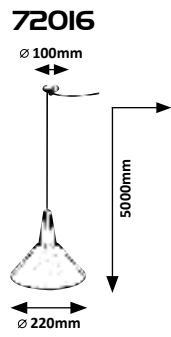

ALATAR

New

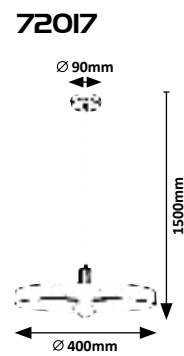

72016 (M)

E27 / 1x max. 40W
IP20 • matte black



72017 (M)

E27 / 1x max. 40W
IP20 • matte black



72016

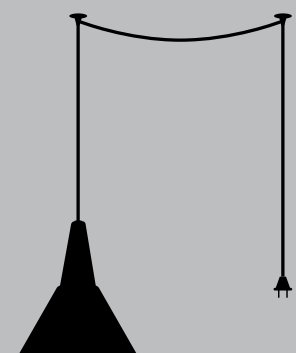



TRINCOLA

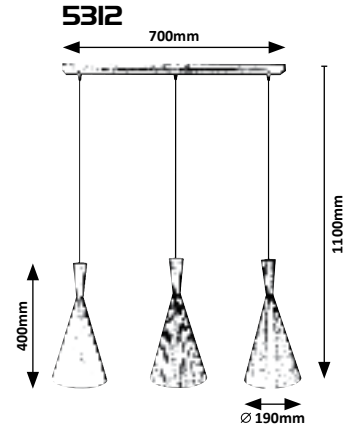
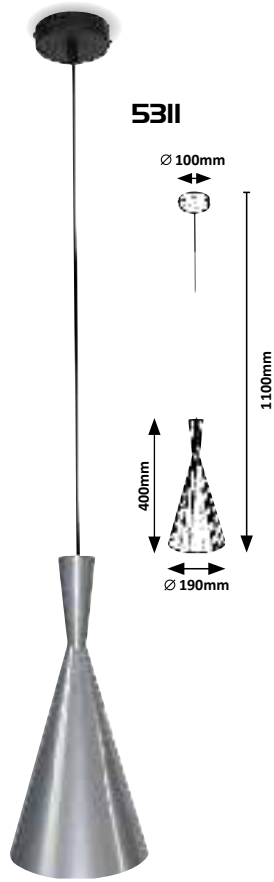

5311 M
 E27 / 1x max. 40W
 IP20
 silver



5312 M
 E27 / 3x max. 40W
 IP20
 white/silver/black



JAROD

New

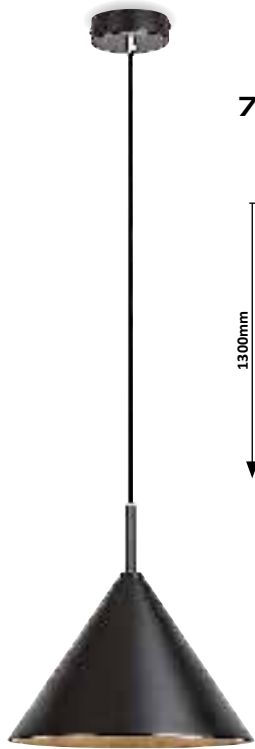

72007

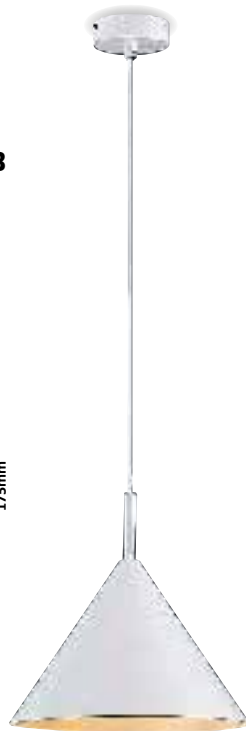
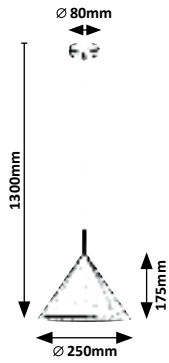

72008

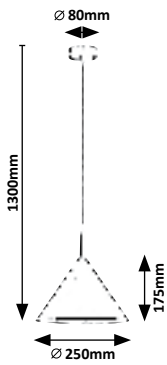

NEVA

WOOD
TEXTILE
CABLE

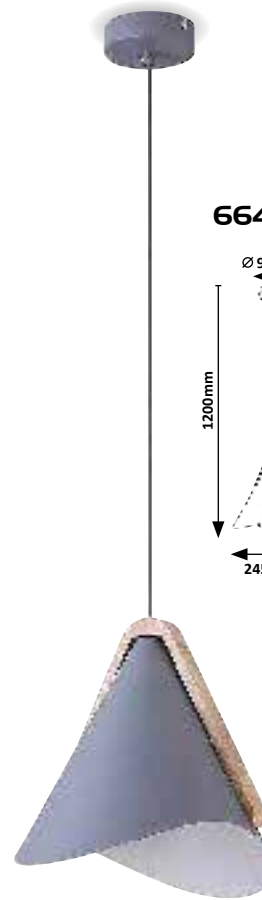

6649

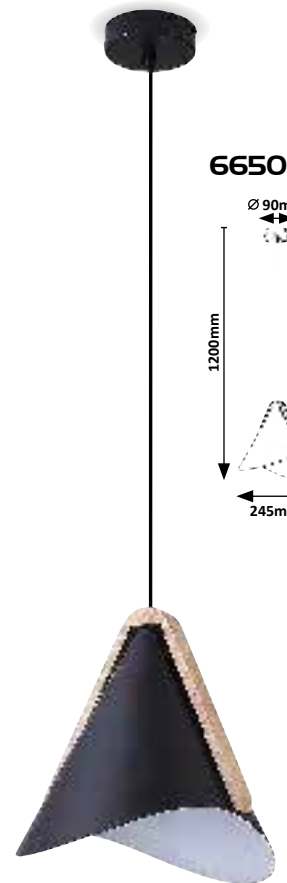
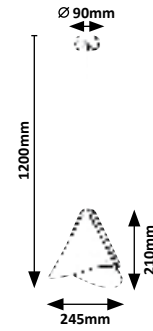

6650

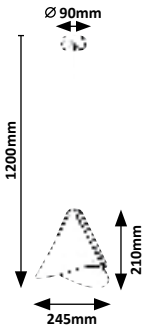

72007

(M)

☒ E27 / 1x max. 40W
IP20
black



4 742946 720070

72008

(M)

☒ E27 / 1x max. 40W
IP20
white



4 742946 720087

6649

(M) (W)

☒ E27 / 1x max. 60W
IP20
grey/beech



5 362250 060494

6650

(M) (W)

☒ E27 / 1x max. 60W
IP20
matte black/beech



5 362250 060500

KAIA

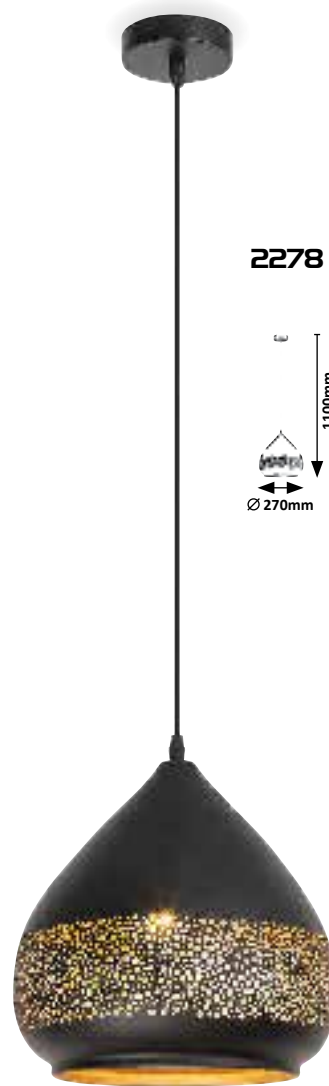

2278

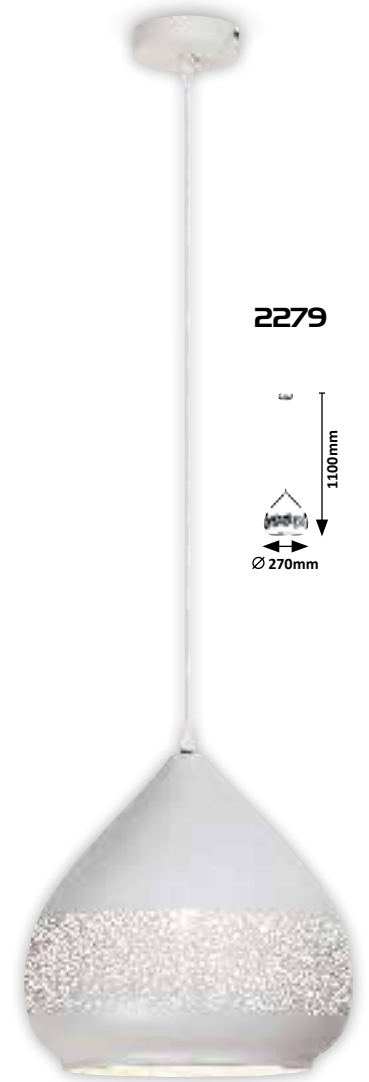
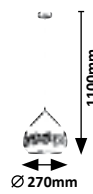

2279

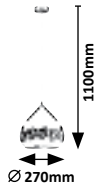

2278 (M)
☒ E27 / 1x max. 40W
IP20
black/gold



2279 (M)
☒ E27 / 1x max. 40W
IP20
white



NORENA

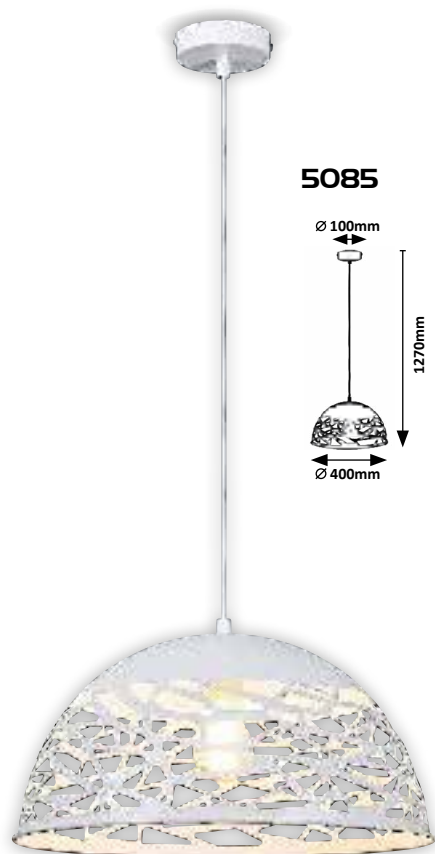

5085

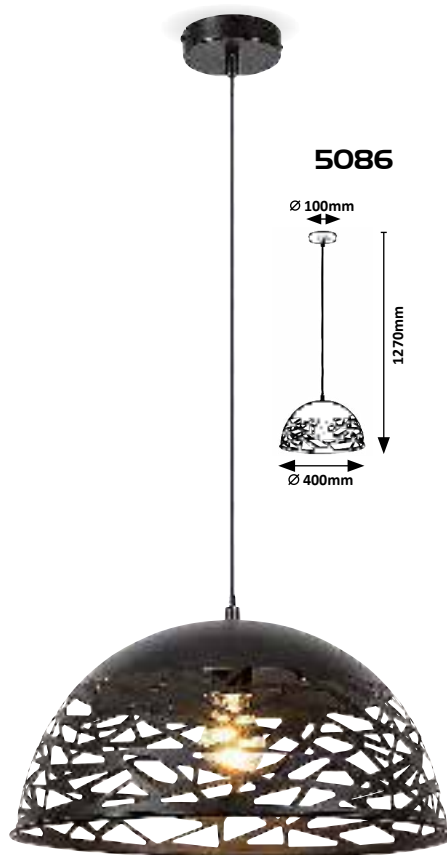
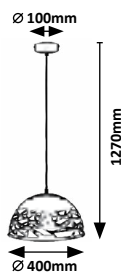

5086

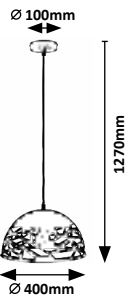

5085



☒ E27 / 1x max. 60W
IP20
matte white



5086



☒ E27 / 1x max. 60W
IP20
matte black



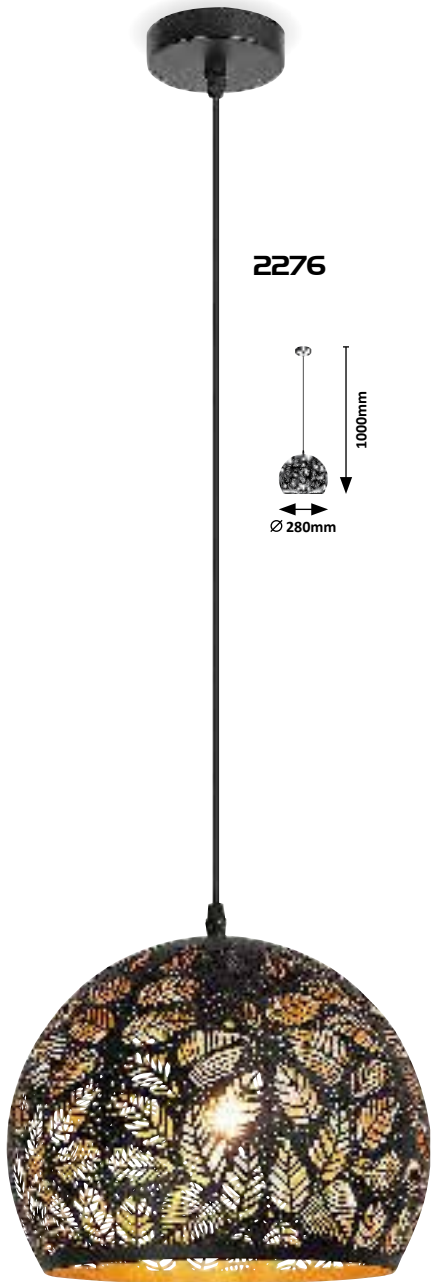

2276

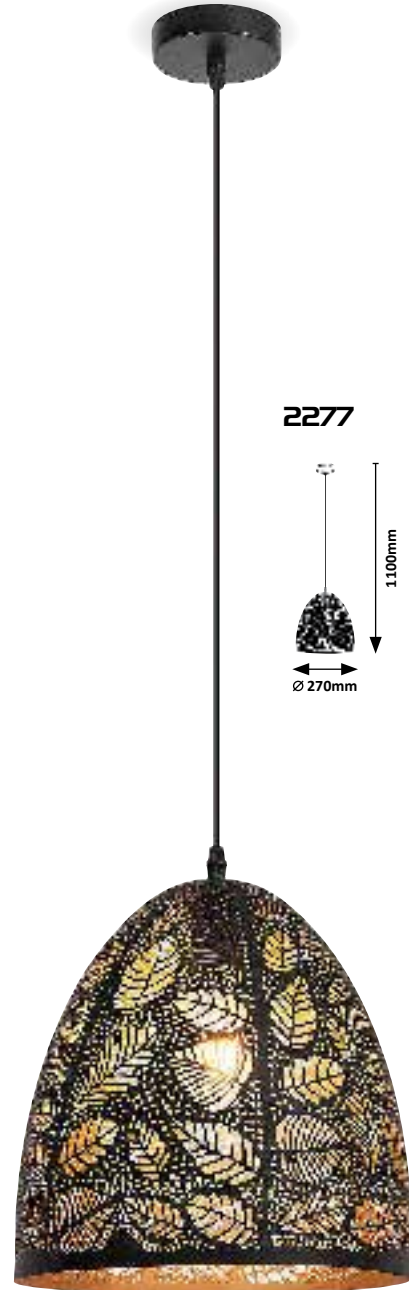
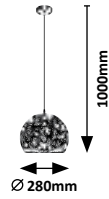

2277



2276 (M)
☒ E27 / 1x max. 40W
IP20
black/gold



2277 (M)
☒ E27 / 1x max. 40W
IP20
black/gold





ALBERTA



5089

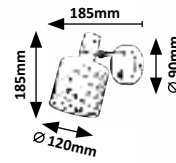

5092

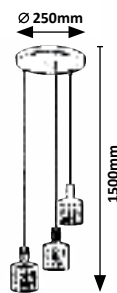

5089



☒ E27 / 1x max. 9W
IP20 • 
gold/white



5092



☒ E27 / 3x max. 9W
IP20
gold/white/black

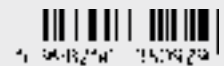

NESRIN



3518

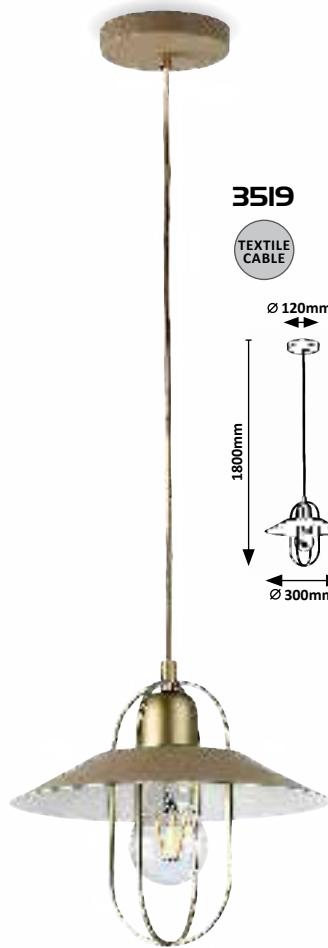
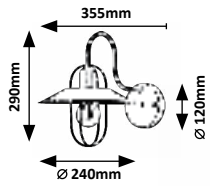

3519

TEXTILE CABLE

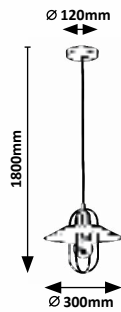

3520

TEXTILE CABLE

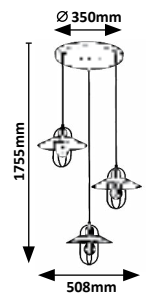

3518 **(M)**

☒ E27 / 1x max. 40W
IP20
gold/beige



5 908250 335180

3519 **(M)**

☒ E27 / 1x max. 40W
IP20
gold/beige

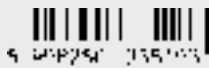

5 908250 335190

3520 **(M)**

☒ E27 / 3x max. 40W
IP20
gold/beige



5 908250 335200

3060



SEPARATELY
SWITCHABLE



CALISTA



3059

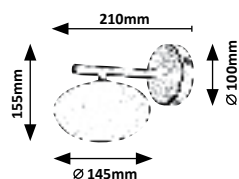

3060

SEPARATELY
SWITCHABLE

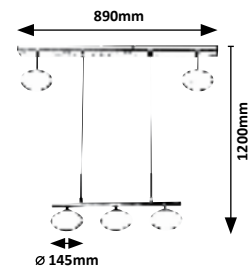

3059 **M G**

☒ G9 / 1x max. 28W
IP20 • 19894
black/white



5 362250 330200

3060 **M G**

☒ G9 / 5x max. 28W
IP20 • 19894
black/white



5 362250 330200

ASLAN



3468

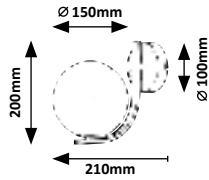

3469

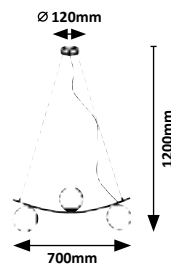

3470

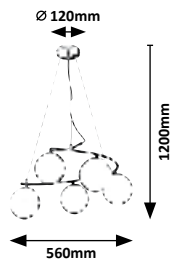

3468 **MG**

☒ E14 / C37 / 1x max. 5W
IP20 • 19937
matte black/white



4 896750 346817

3469 **MG**

☒ E14 / C37 / 3x max. 5W
IP20 • 19937
matte black/white



4 896750 346917

3470 **MG**

☒ E14 / C37 / 5x max. 5W
IP20 • 19937
matte black/white



4 896750 347017

HOLLY

Others /
158-161. Best match



5943

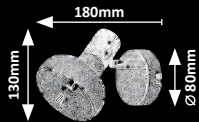

5944

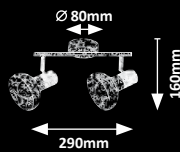

5945

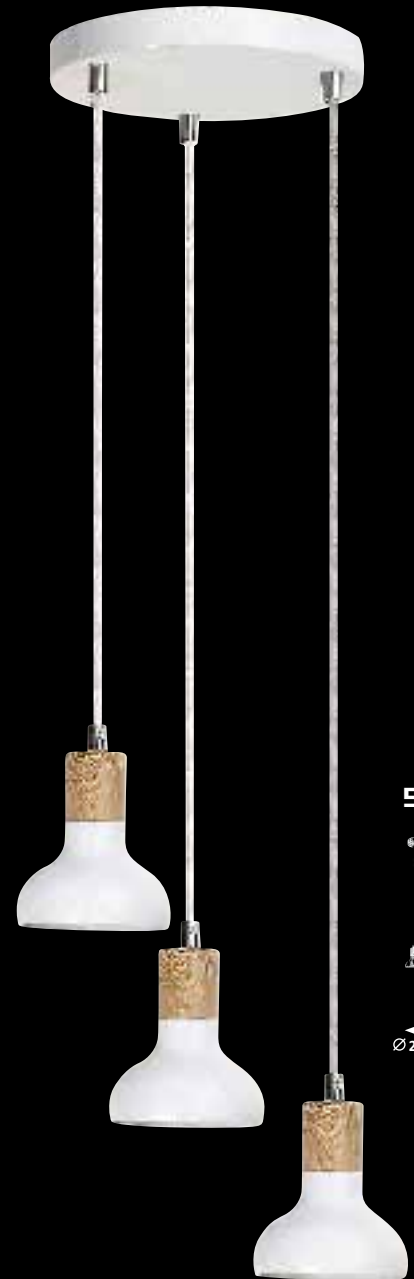
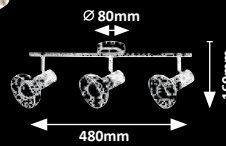

5949

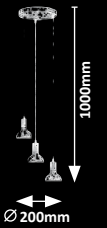

5948

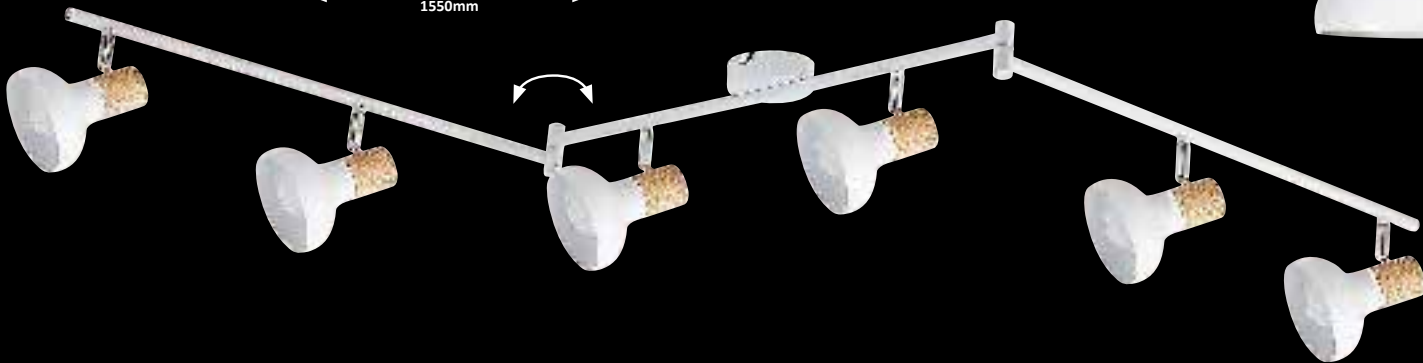
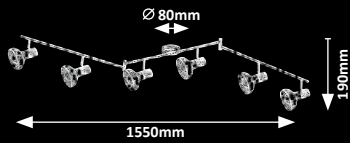

5943

(M)

☒ E14 / 1x max. 40W
IP20
white/beech/chrome



5944

(M)

☒ E14 / 2x max. 40W
IP20
white/beech/chrome



5945

(M)

☒ E14 / 3x max. 40W
IP20
white/beech/chrome



5948

(M)

☒ E14 / 6x max. 40W
IP20
white/beech/chrome



5949

(M)

☒ E14 / 3x max. 40W
IP20
white/beech/chrome



HOLLY

SADIE

Others /
Best match

TEXTILE
CABLE



5947

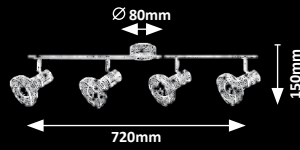

5946

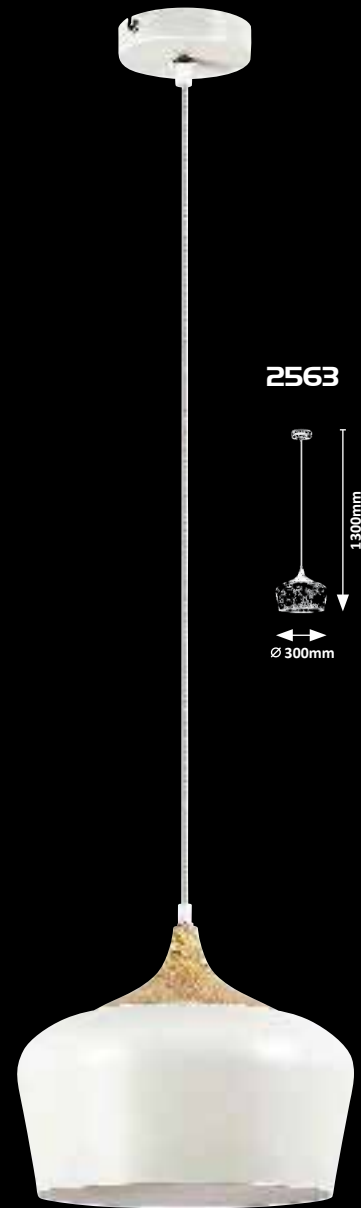
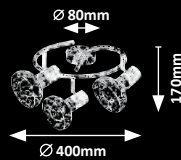

2563

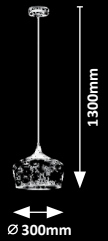

5946 (M)

☒ E14 / 3x max. 40W
IP20
white/beech/chrome



5947 (M)

☒ E14 / 4x max. 40W
IP20
white/beech/chrome



2563 (M)

☒ E27 / 1x max. 60W
IP20
white/beech



INDIRECT 3090



CINNAMON



3090

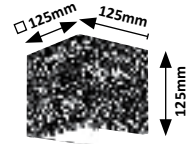

3091

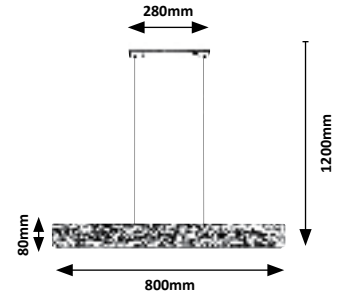

3090 (M P W)

LED / 7W
(340lm, 3000K) incl.
IP20
oak/white



5 362250 330307

3091 (M P W)

LED / 34W
(1770lm, 3000K) incl.
IP20
oak/white



5 362250 330314

MARLON

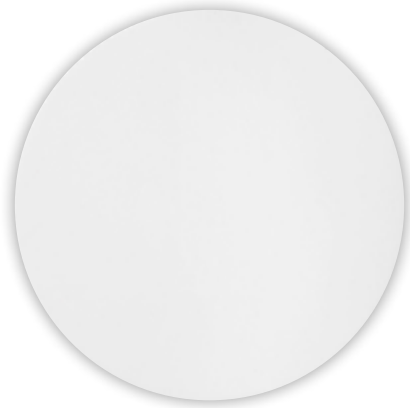

I43I

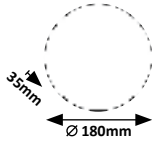

I433

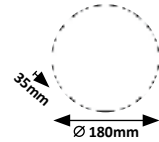

I43I



LED / 8W
(640lm, 3000K) incl.
IP20
white



5 362250 314310

I433



LED / 8W
(640lm, 3000K) incl.
IP20
black



5 362250 314330



TORAS

WOOD  **New**

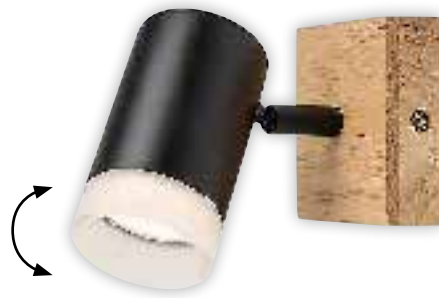

73121

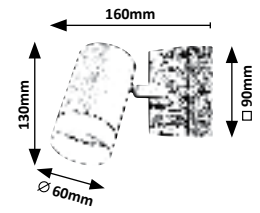

73122

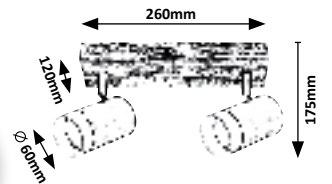

73123

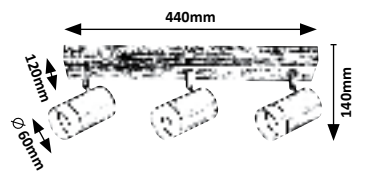

73121 **MWP**

☒ GU10 / 1x max. 5W
IP20
oak/black



73122 **MWP**

☒ GU10 / 2x max. 5W
IP20
oak/black



73123 **MWP**

☒ GU10 / 3x max. 5W
IP20
oak/black



TORAS

WOOD

New

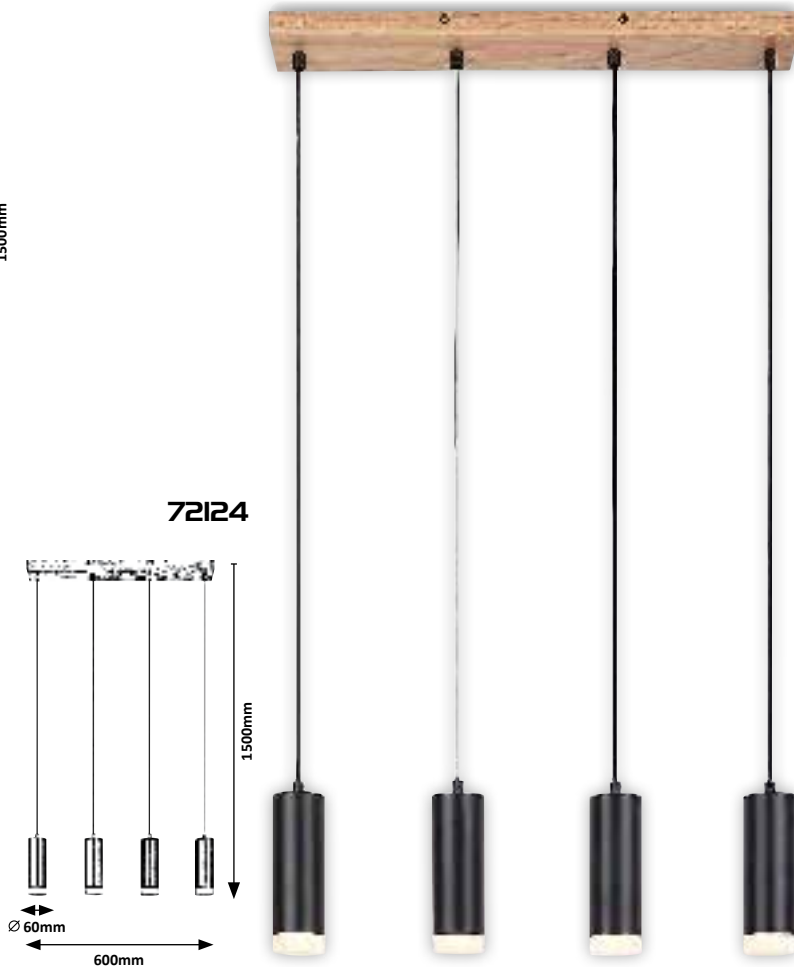
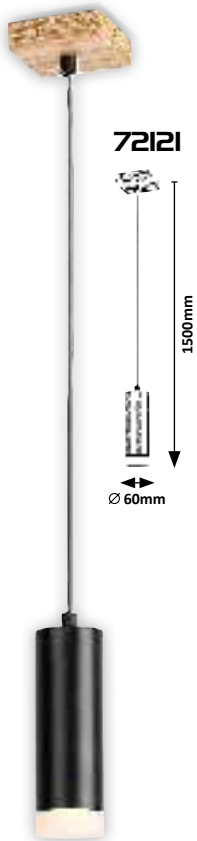
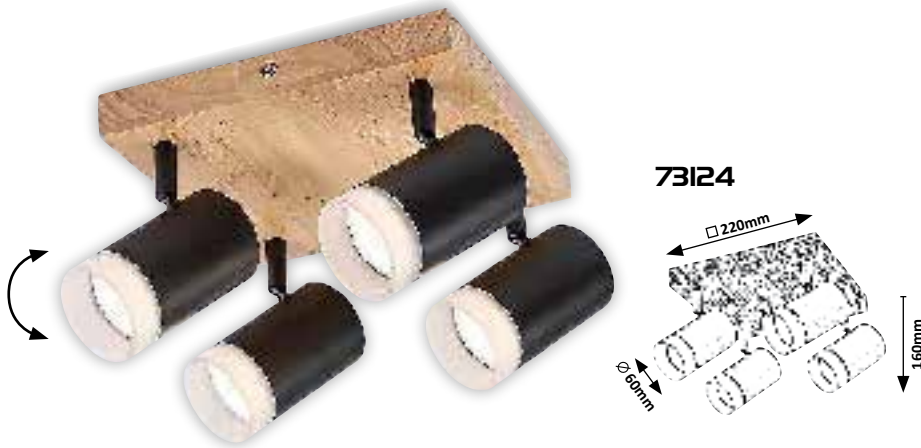

73124 MWP

☒ GU10 / 4x max. 5W
IP20
oak/black



72121 MWP

☒ GU10 / 1x max. 5W
IP20
oak/black



72124 MWP

☒ GU10 / 4x max. 5W
IP20
oak/black



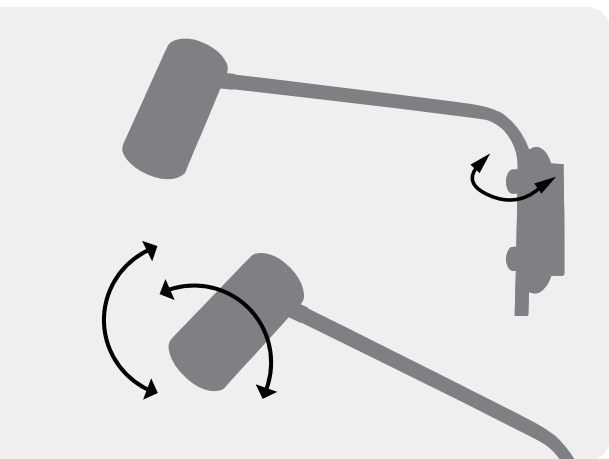

ZIRCON

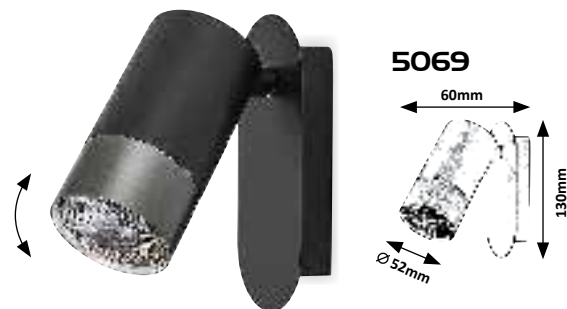

5069 (M)
 ☒ GU10 / 1x max. 5W
 IP20
 matte black/silver



5070 (M)
 ☒ GU10 / 2x max. 5W
 IP20
 matte black/silver



5072 (M)
 ☒ GU10 / 1x max. 5W
 IP20 • ☒
 matte black/silver



ZIRCON

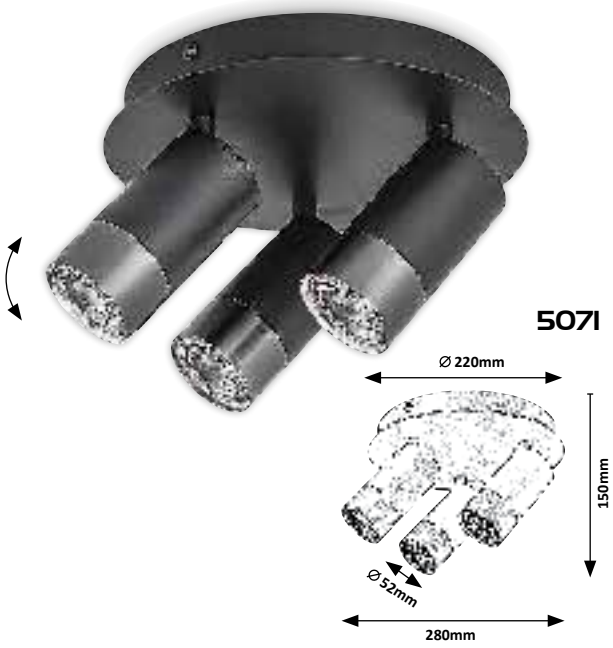

5071 **(M)**
 ☒ GU10 / 3x max. 5W
 IP20
 matte black/silver



5073 **(M)**
 ☒ GU10 / 2x max. 5W
 IP20
 matte black/silver



5074 **(M)**
 ☒ GU10 / 1x max. 5W
 IP20
 matte black/silver



5075 **(M)**
 ☒ GU10 / 1x max. 5W
 IP20
 matte black/silver



5076 **(M)**
 ☒ GU10 / 1x max. 5W
 IP20
 matte black/silver



AMADEO

5 YEAR GUARANTEE

LED built-in

NATURAL White

INDIRECT

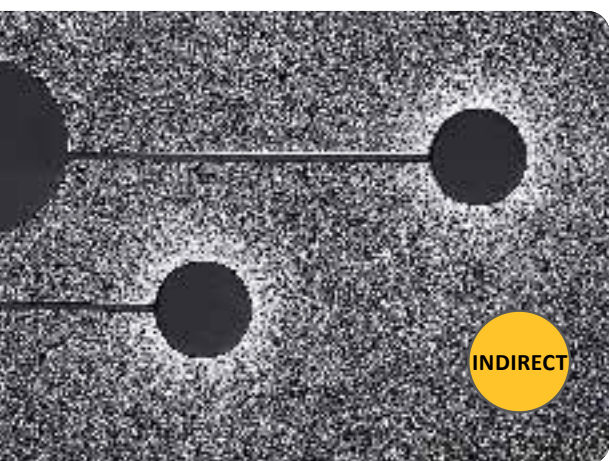
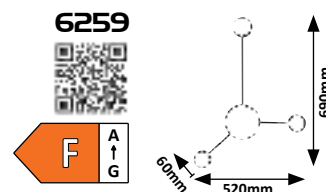
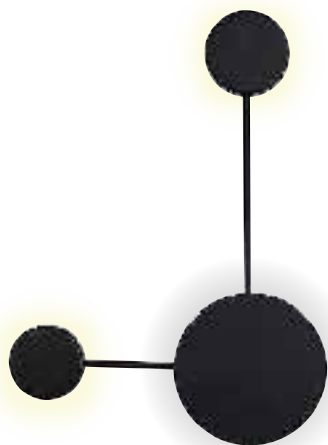

INDIRECT

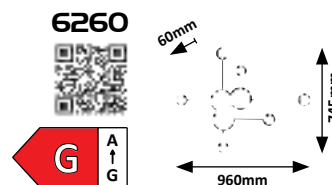
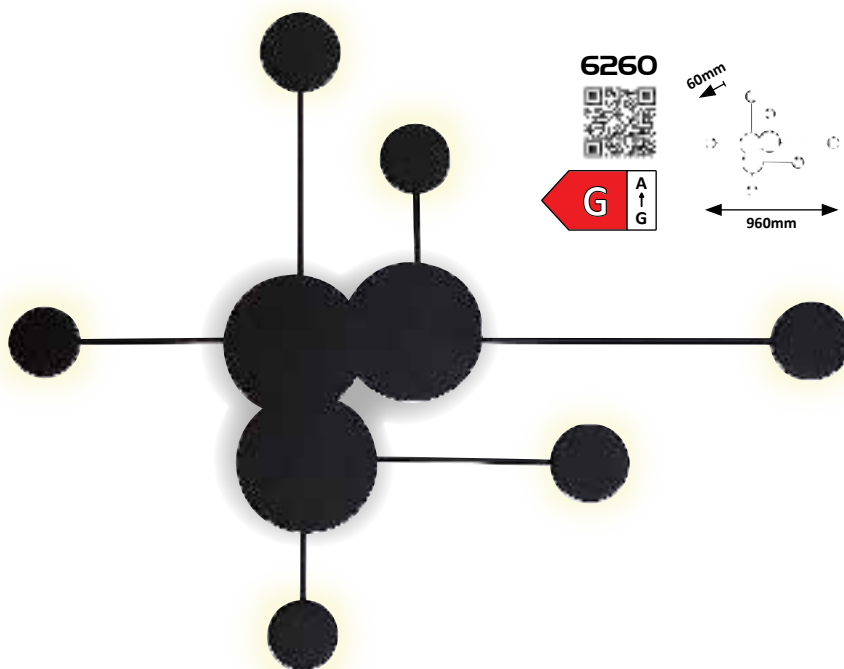

6258 (M) (P)

LED / 7W
(500lm, 4000K) incl.
IP20
black



6259 (M) (P)

LED / 10,5W
(750lm, 4000K) incl.
IP20
black

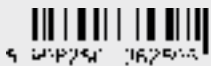

6260 (M) (P)

LED / 21W
(1500lm, 4000K) incl.
IP20
black



SOLOMON

5 YEAR
WARRANTY

LED
built-in

NATURAL
White

G
A
↑
G



6355

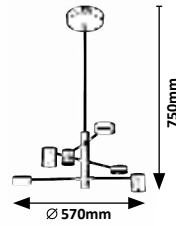

6355 (M) (A)

LED / 30W
(2400lm, 4000K) incl.
IP20
matte black

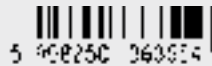

5 90250 96089

KAUNAS

INDIRECT



7017

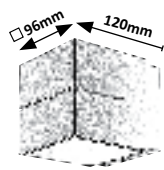

7018

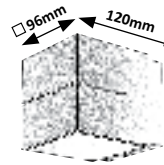

7019

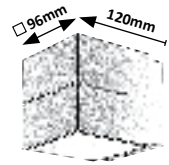

7020

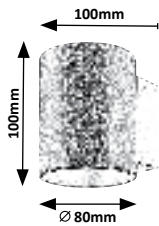

7021

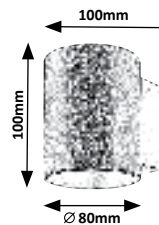

7022

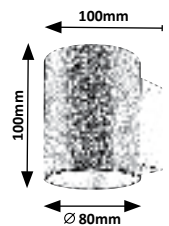

7017 (M)
 ☒ G9 / 1x max. 10W
 IP20
 matte black



7018 (M)
 ☒ G9 / 1x max. 10W
 IP20
 matte white



7019 (M)
 ☒ G9 / 1x max. 10W
 IP20
 brushed aluminium



7020 (M)
 ☒ G9 / 1x max. 10W
 IP20
 matte black



7021 (M)
 ☒ G9 / 1x max. 10W
 IP20
 matte white



7022 (M)
 ☒ G9 / 1x max. 10W
 IP20
 brushed aluminium



KAUNAS

INDIRECT



7023

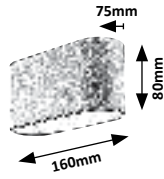

7024

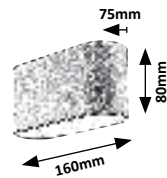

7025

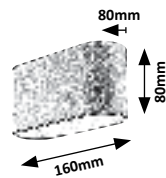

7023, 7024, 7025

INDIRECT



7023 (M)

☒ G9 / 1x max. 10W
IP20
matte black



7024 (M)

☒ G9 / 1x max. 10W
IP20
matte white



7025 (M)

☒ G9 / 1x max. 10W
IP20
brushed aluminium



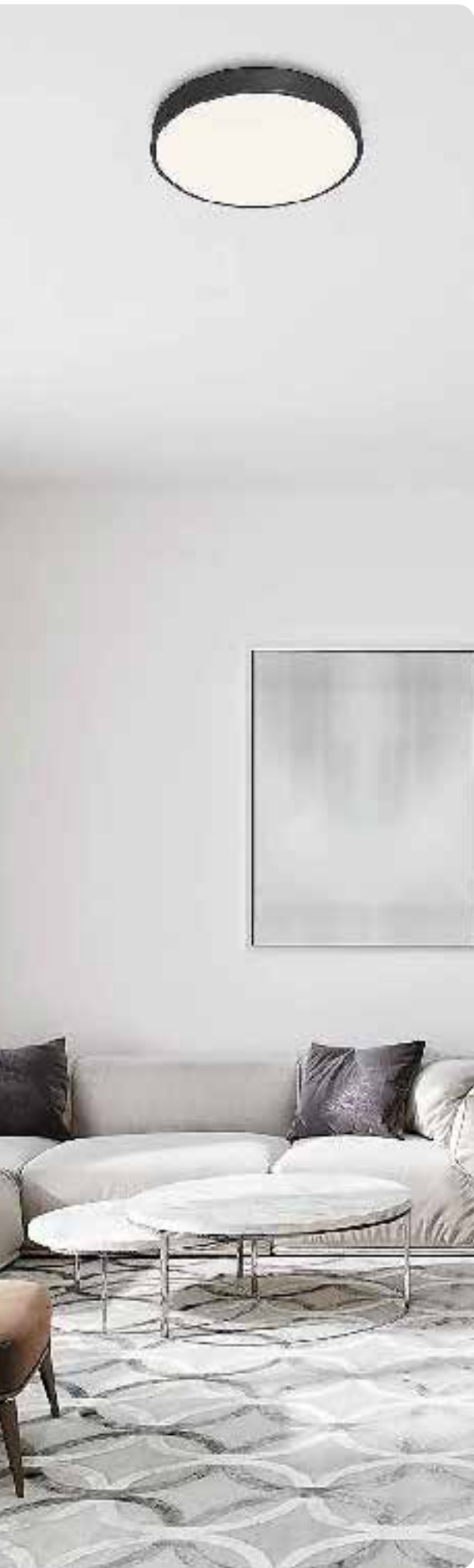

TESIA

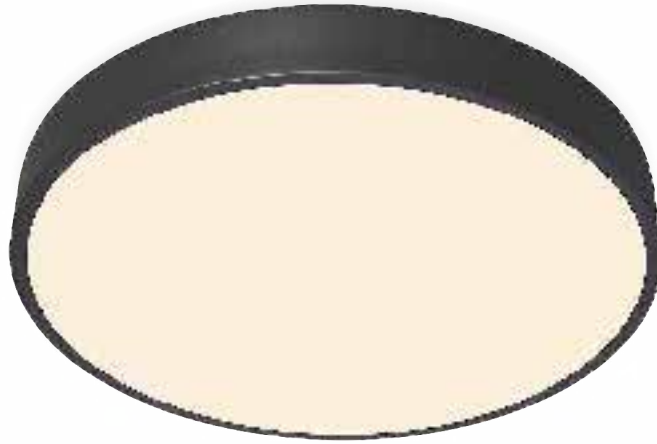

3314

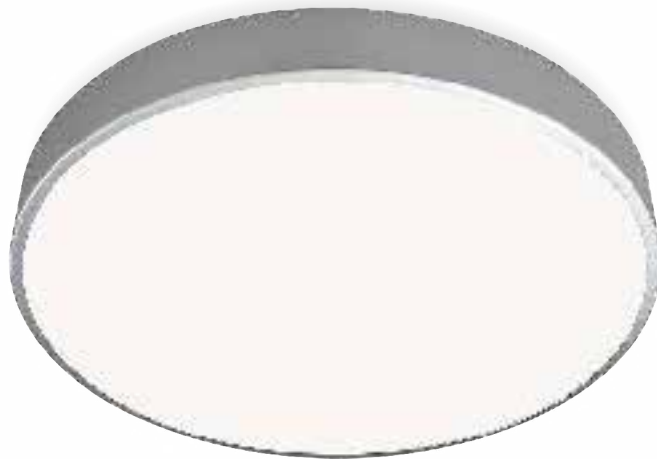
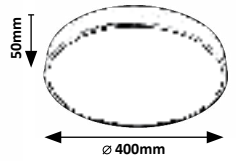

3315

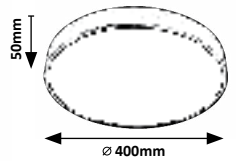

3314 (M) (P)

LED / 36W
(2600lm, 3000K) incl.
IP20 • 19945
matte black/white



3315 (M) (P)

LED / 36W
(2600lm, 4000K) incl.
IP20 • 19945
silver/white



TESIA

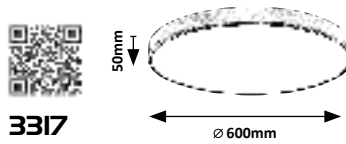
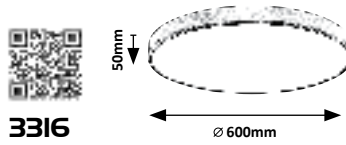

3316 (M) (P)

LED / 60W
 (5000lm, 3000-6000K) incl.
 IP20 • 19946 • 551
 matte black/white



3317 (M) (P)

LED / 60W
 (5000lm, 3000-6000K) incl.
 IP20 • 19946 • 551
 silver/white



3316, 3317



71041, 71042



TESIA

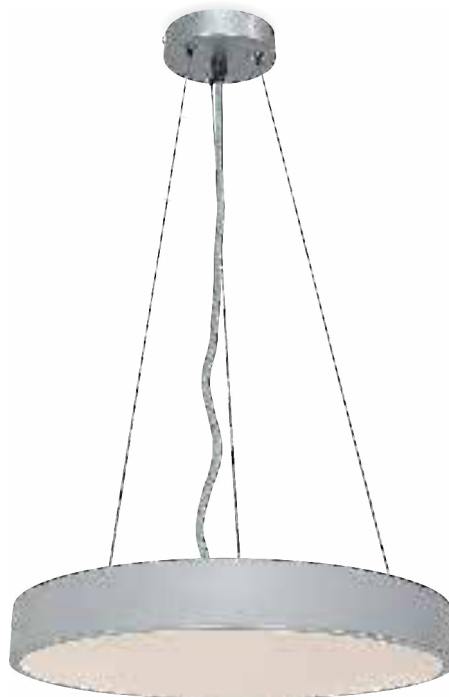
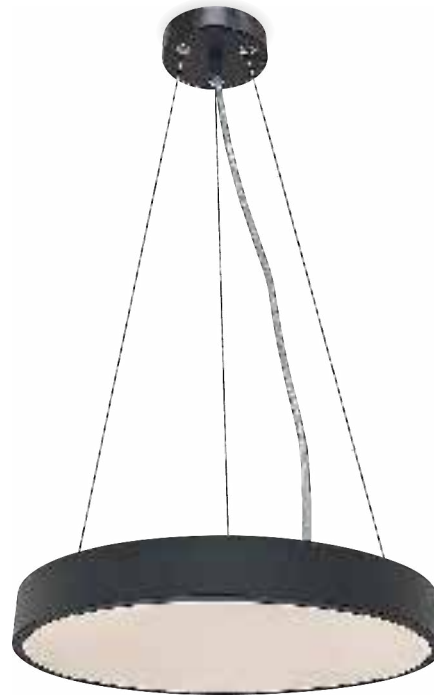

71039

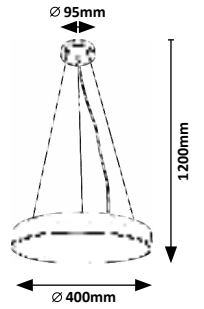

71041

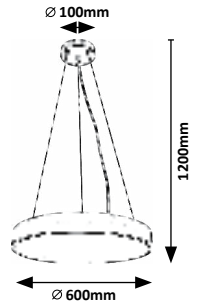

71040

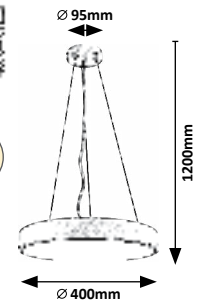

71042

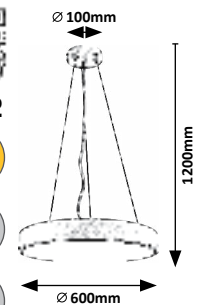

71039 (M) (P)

LED / 36W (2000lm, 2880lm; 3000K) incl. • IP20
19945
black/white



71040 (M) (P)

LED / 36W (2550lm, 2880lm; 4000K) incl. • IP20
19945
silver/white



71041 (M) (P)

LED / 60W (2700lm, 4800lm; 3000K-6000K) incl. • IP20
19946 • 551
black/white



71042 (M) (P)

LED / 60W (3500lm, 4800lm; 3000K-6000K) incl. • IP20
19946 • 551
silver/white



TESIA



71037

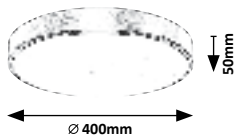

71038



71037 **M P**

LED / 36W (2300lm, 2880lm; 3000K) incl. • IP20
19945
gold/white



71038 **M P**

LED / 60W (3760lm, 4800lm; 3000K-6000K) incl. • IP20
19946 • 551
gold/white



CARMELLA



5052

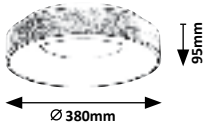

5053

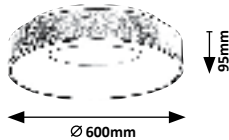

5056

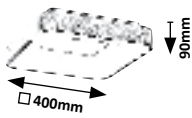

5057

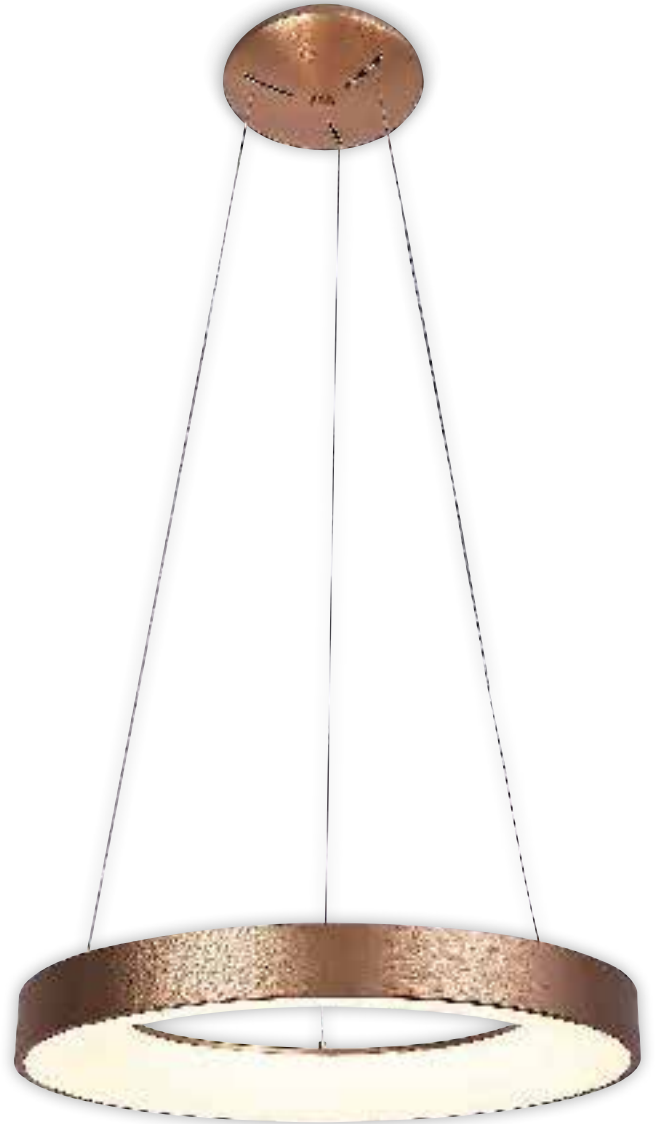
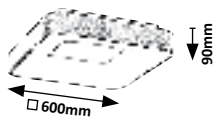

5054

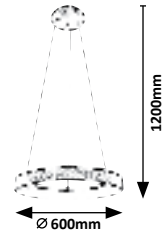

5055

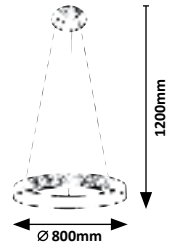

5052 (M) (A)

LED / 30W
(1950lm, 4000K) incl.
IP20
gold/white



5053 (M) (A)

LED / 50W
(3400lm, 4000K) incl.
IP20
gold/white

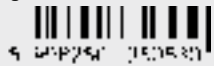

5054 (M) (A)

LED / 50W
(3350lm, 4000K) incl.
IP20
gold/white



5055 (M) (A)

LED / 80W
(6335lm, 4000K) incl.
IP20
gold/white

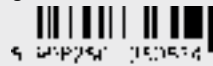

5056 (M) (A)

LED / 30W
(1950lm, 4000K) incl.
IP20
gold/white

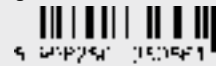

5057 (M) (A)

LED / 50W
(3889lm, 4000K) incl.
IP20
gold/white





ADELINE



3926

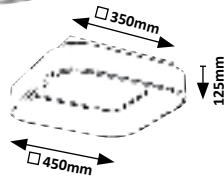

3928

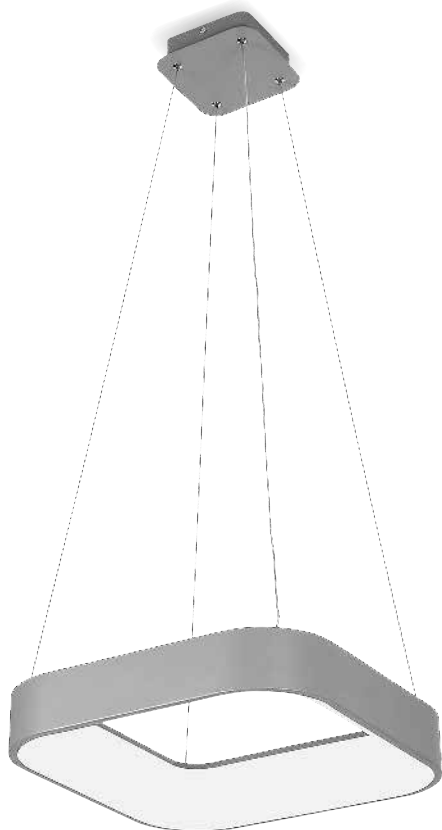
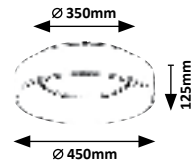

3927

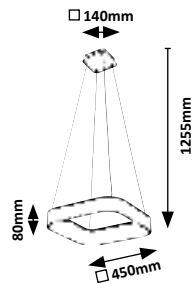

3929

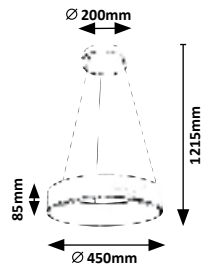

3926 (M) (A)

LED / 28W
(1800lm, 3000K-6000K) incl.
IP20 • 532
grey/white



S 39229C 333270

3927 (M) (A)

LED / 28W
(1800lm, 3000K-6000K) incl.
IP20 • 532
grey/white



S 39229C 333270

3928 (M) (A)

LED / 24W
(1500lm, 3000K-6000K) incl.
IP20 • 532
grey/white



S 39229C 333283

3929 (M) (A)

LED / 24W
(1500lm, 3000K-6000K) incl.
IP20 • 532
grey/white



S 39229C 333290

OTHELLO



6299

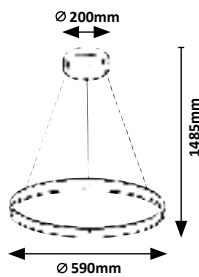

6299 (M SI)

LED / 36W
(1800lm, 3000K-6000K) incl.
IP20 • 525
grey/white



5 362250 362291





CEILO



3082

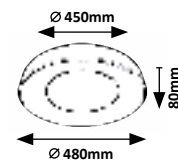

3083

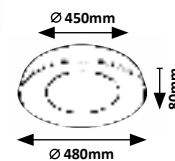

3082, 3083

BACKLIGHT effect



3082 (M) (P)

LED / 38W
(3200lm, 3000K-6500K) incl.
IP20 • 502
black/white

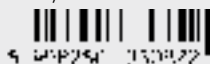

4 244741 150972

3083 (M) (P)

LED / 38W
(3200lm, 3000K-6500K) incl.
IP20 • 502
white



4 244741 150989

CEILO



72001, 72002

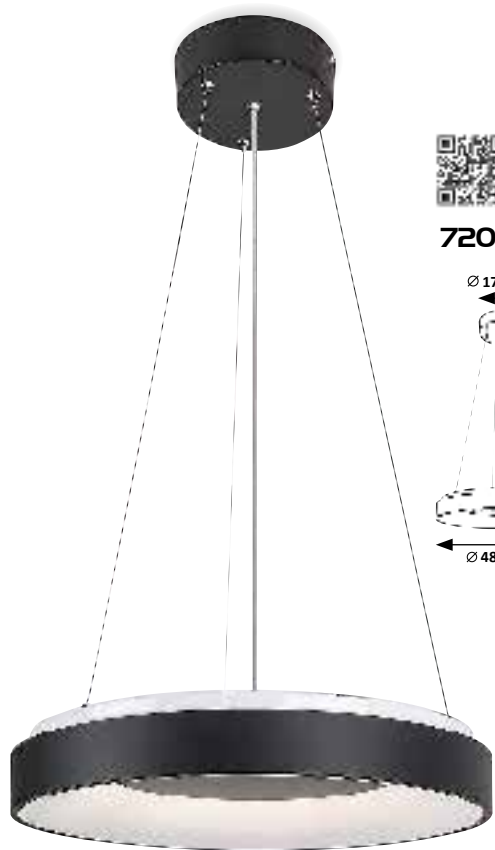

72001

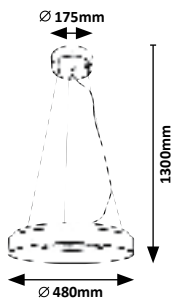

72002

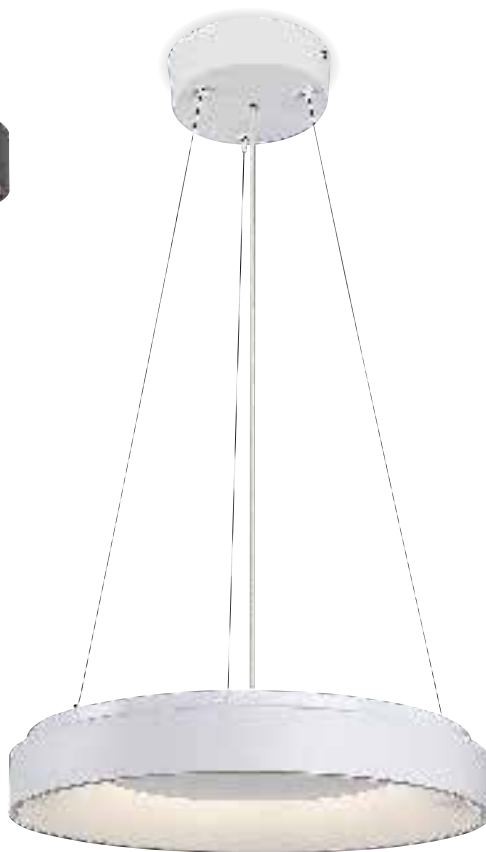
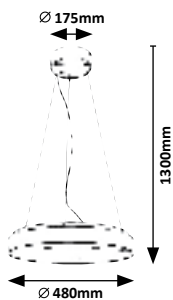

72001 (M) (P)

LED / 38W
 (3150lm, 3800lm;
 3000K-6500K) incl. • IP20 • 546
 black/white



72002 (M) (P)

LED / 38W
 (3150lm, 3800lm;
 3000K-6500K) incl. • IP20 • 546
 white



RENATA

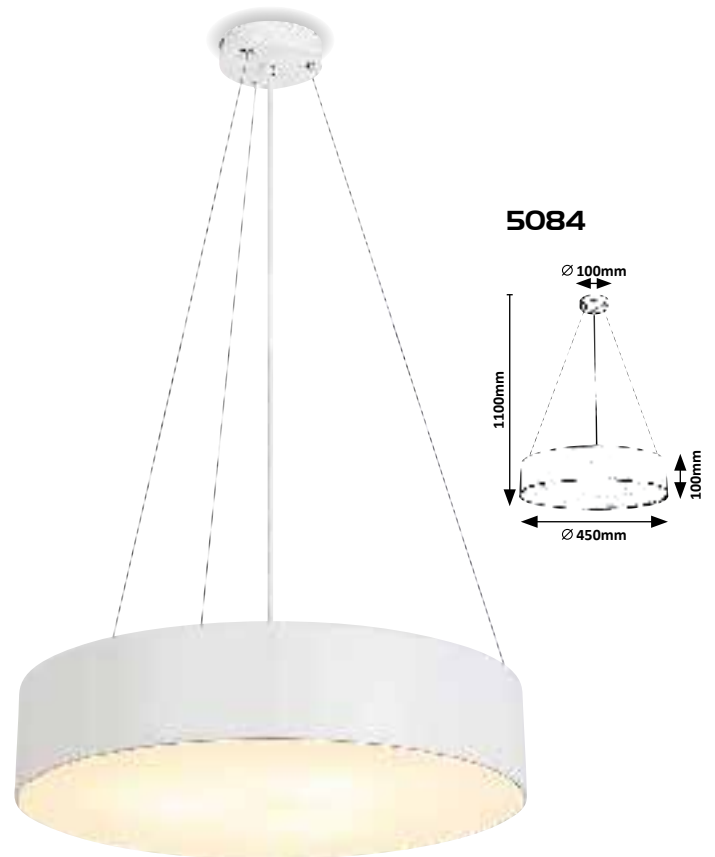
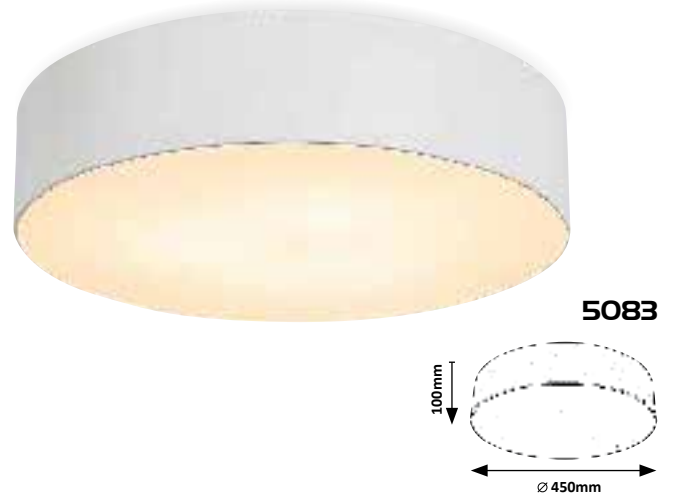

5081 (M) (A)

☒ E27 / G45 / 3x max. 10W
IP20 • 19837
matte black/white



5082 (M) (A)

☒ E27 / G45 / 3x max. 10W
IP20 • 19837
matte black/white



5083 (M) (A)

☒ E27 / G45 / 3x max. 10W
IP20 • 19837
matte white/white



5084 (M) (A)

☒ E27 / G45 / 3x max. 10W
IP20 • 19837
matte white/white



ALDONA

VELVET 410. Others / Best match

3860

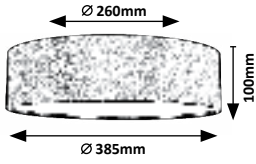

3859

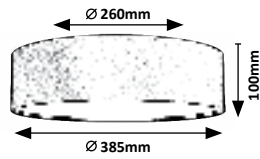

OTILIA

5 YEARS GUARANTEE LED built-in WARM White G A ↑ G



3308

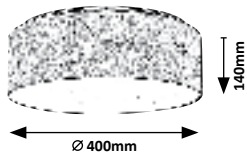

3307

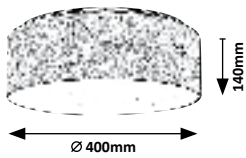

3859 (M) (T)

⊗ E27 / 2x max. 10W
IP20 • 19883, 19885
blue/white



9 549250 335590

3860 (M) (T)

⊗ E27 / 2x max. 10W
IP20 • 19884, 19886
grey/white

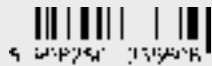

9 549250 335600

3307 (M) (T)

⊗ LED / 22W
(970lm, 3000K) incl.
IP20 • 19933, 19934
grey/white

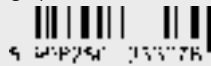

9 549250 333070

3308 (M) (T)

⊗ LED / 22W
(970lm, 3000K) incl.
IP20 • 19935, 19934
cream/white



9 549250 333080



MORPHEUS



5685

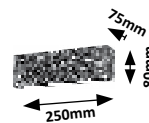

5684

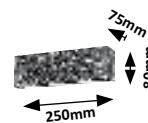

ARTEMIS



5681

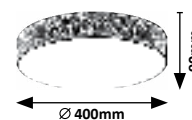

5683

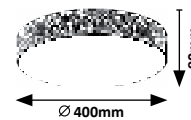

5684 (M) (T)

LED / 6W
(420lm, 3000K) incl.
IP20 • 19648, 19738
gold foil/white



S 36225C 350873

5685 (M) (T)

LED / 6W
(420lm, 3000K) incl.
IP20 • 19649, 19738
grey/white



S 36225C 350873

5681 (M) (T)

LED / 24W
(1950lm, 3000K) incl.
IP20 • 19645, 19737
grey/white



S 36225C 350873

5683 (M) (T)

LED / 24W
(1950lm, 3000K) incl.
IP20 • 19647, 19737
gold foil/white



S 36225C 350873

MIGUEL

WOOD



3244

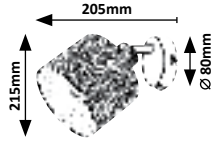

3245

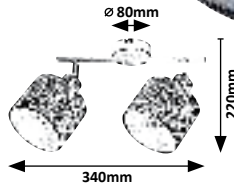

3246

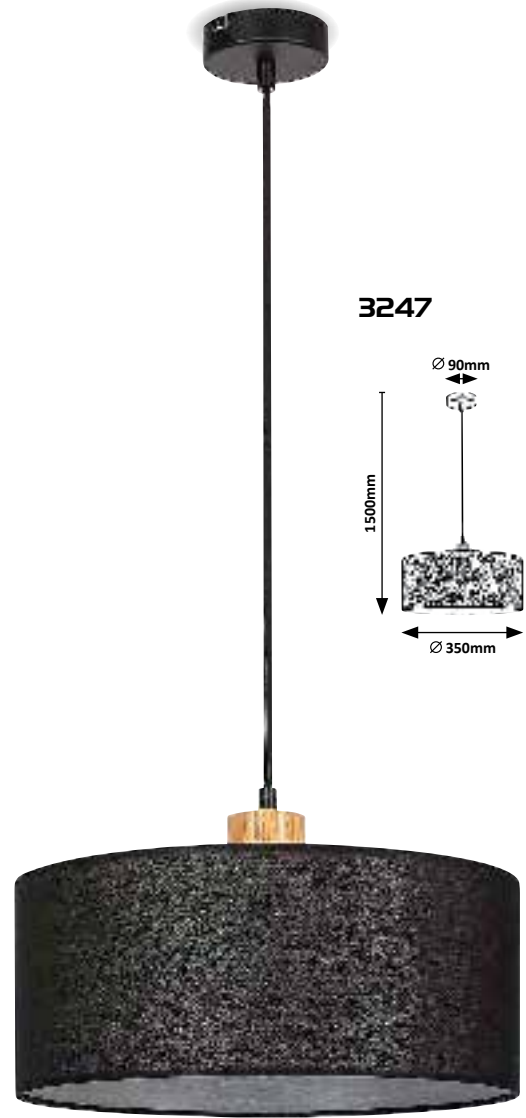
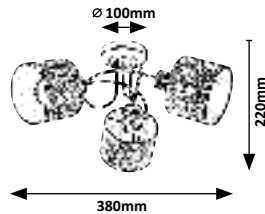

3247

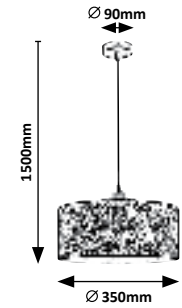

3244 MWT

☒ E14 / 1x max. 40W
IP20 • 19997 •
oak/black



S 362250 332444

3245 MWT

☒ E14 / 2x max. 40W
IP20 • 19997 •
oak/black



S 362250 332451

3246 MWT

☒ E14 / 3x max. 40W
IP20 • 19997 •
oak/black



S 362250 332462

3247 MWT

☒ E27 / 1x max. 40W
IP20 • 19998 •
oak/black



S 362250 332473

ANETA



5093

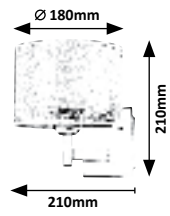

5095

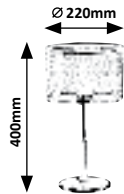

5094

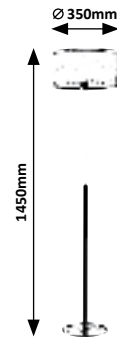

5093 (M) (T)

☒ E27 / G45 / 1x max. 40W
IP20 • 19856
black/beige



5094 (M) (T)

☒ E27 / 1x max. 40W
IP20 • 19857
black/beige

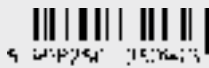

5095 (M) (T)

☒ E27 / 1x max. 40W
IP20 • 19858
black/beige



ANETA



5096

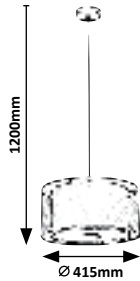

5097

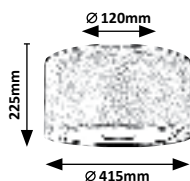

5096 (M) (T)

☒ E27 / G45 / 3x max. 40W
IP20 • 19859
black/beige

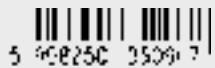

5 90250 35097

5097 (M) (T)

☒ E27 / G45 / 3x max. 40W
IP20 • 19859
black/beige

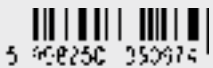

5 90250 35097

ANASTASIA



2628

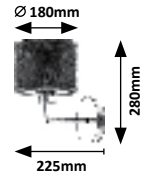

2634

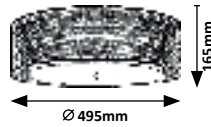

2631

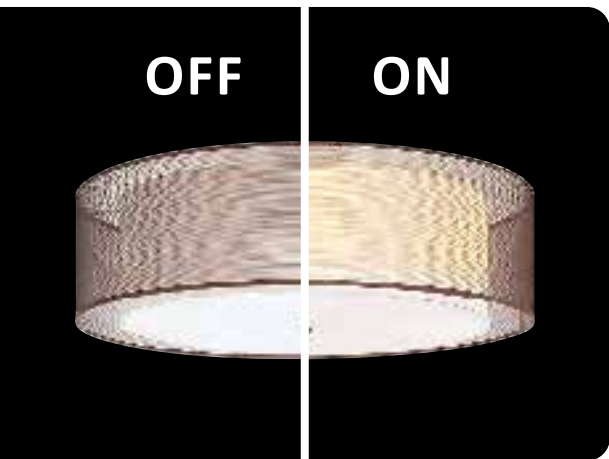
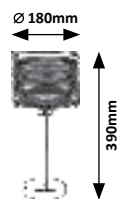

2628 (M) (T)

☒ E27 / 1x max. 60W
IP20 • 19500 (Ø180mm)
chrome/white/brown



2631 (M) (T)

☒ E27 / 1x max. 60W
IP20 • 19500 (Ø180mm)
chrome/white/brown



2634 (M) (T)

☒ E14 / 3x max. 25W
IP20 • 19503 (Ø495mm)
chrome/white/brown



ANASTASIA



E27
1x max. 60W excl.



LED built-in
1W



2629

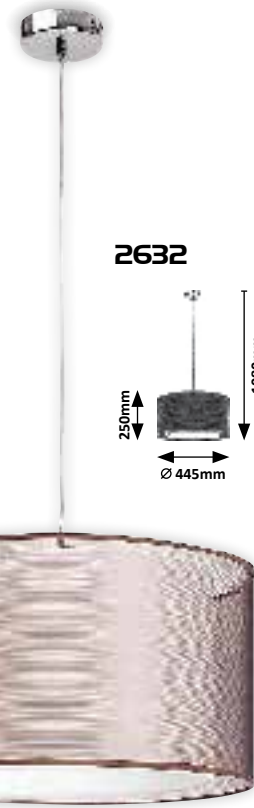
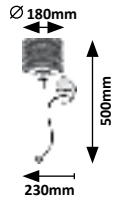

2632

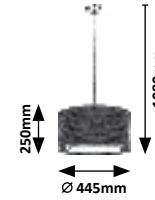

2630

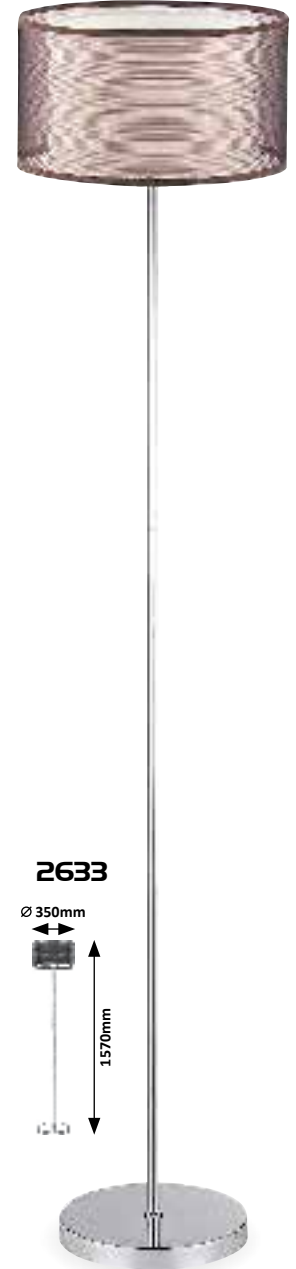
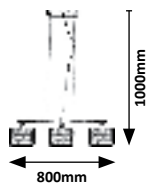

2633

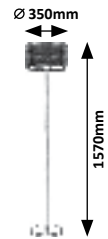

2629 **(M T)**

☒ E27 / 1x max. 60W
☒ LED / 1W (85lm, 4000K) incl.
IP20 • • 19500 (ø180mm)
chrome/white/brown



S 39229C 22629C

2630 **(M T)**

☒ E27 / 3x max. 60W
IP20 • 19500 (ø180mm)
chrome/white/brown



S 39229C 22630C

2632 **(M T)**

☒ E27 / 1x max. 60W
IP20 • 19501 (ø445mm)
chrome/white/brown



S 39229C 22632C

2633 **(M T)**

☒ E27 / 1x max. 60W
IP20 • 19502 (ø350mm)
chrome/white/brown



S 39229C 22633C

BASIL

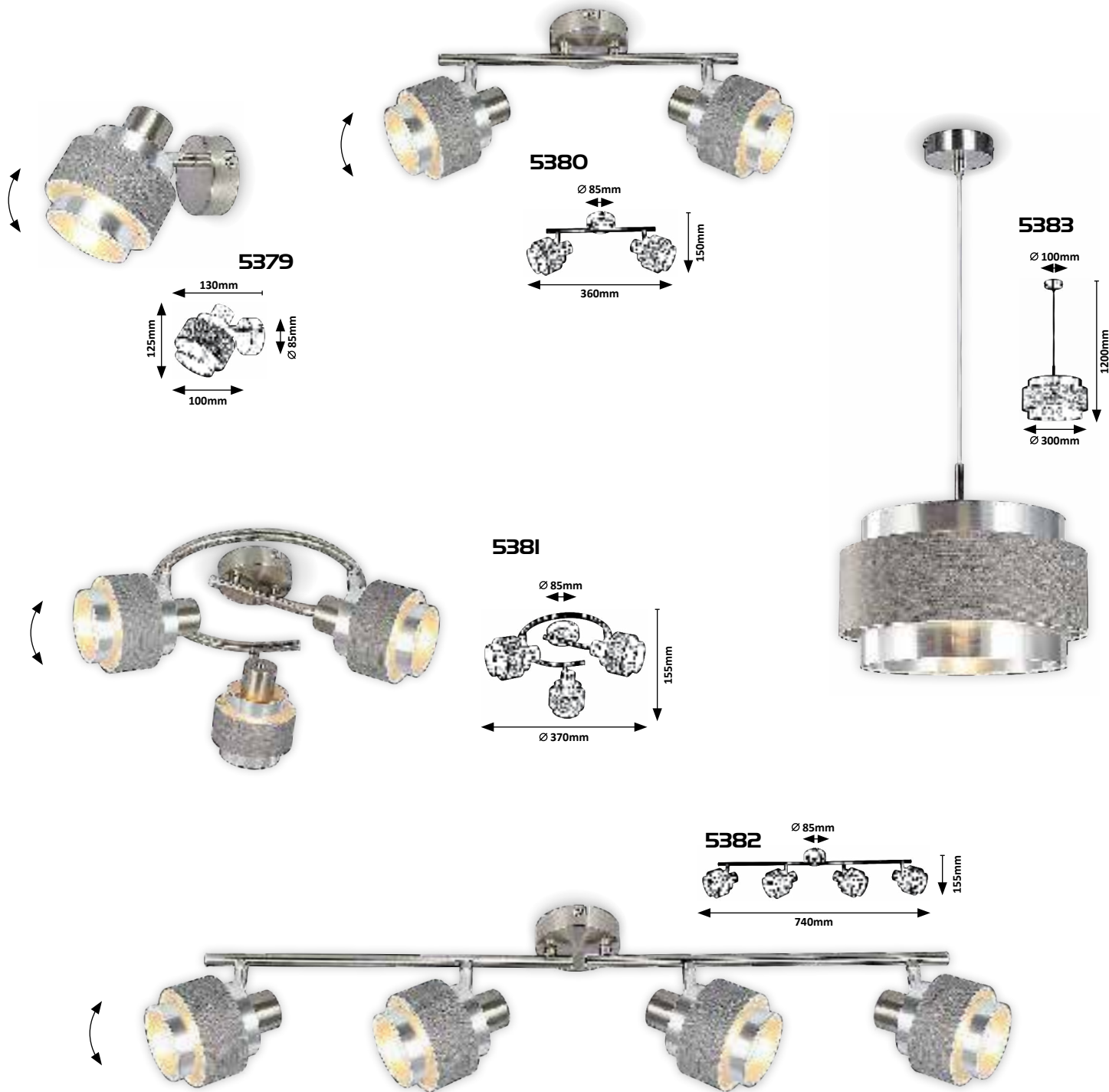

5379 (M P)

☒ E14 / 1x max. 10W
IP20 • 19795
satin chrome/silver oak



5380 (M P)

☒ E14 / 2x max. 10W
IP20 • 19795
satin chrome/silver oak

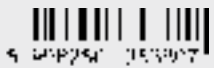

5381 (M P)

☒ E14 / 3x max. 10W
IP20 • 19795
satin chrome/silver oak

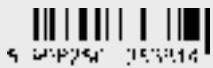

5382 (M P)

☒ E14 / 4x max. 10W
IP20 • 19795
satin chrome/silver oak

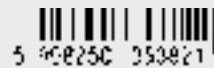

5383 (M P)

☒ E27 / 1x max. 40W
IP20 • 19796
satin chrome/silver oak



HILARY



5661

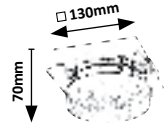

5662

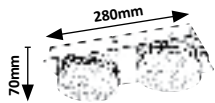

5663

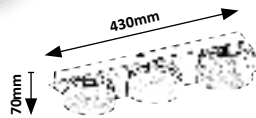

5664

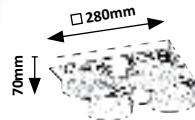

5661 (M) (P)

LED / 5W
(400lm, 4000K) incl.
IP20 • 19736
chrome/white



S 36R25C 350227

5662 (M) (P)

LED / 10W
(800lm, 4000K) incl.
IP20 • 19736
chrome/white



S 36R25C 350224

5663 (M) (P)

LED / 15W
(1200lm, 4000K) incl.
IP20 • 19736
chrome/white



S 36R25C 350221

5664 (M) (P)

LED / 20W
(1600lm, 4000K) incl.
IP20 • 19736
chrome/white



S 36R25C 350226

MEREDITH

5
YEAR
GUARANTEE

LED
built-in

NATURAL
White

G
A
↑
G



2479

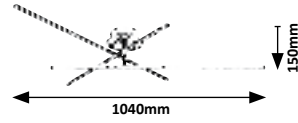

2478

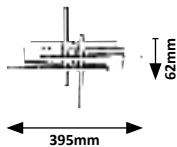

2480

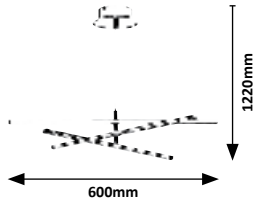

2481



2478 (M) (P)

LED / 20W
(1440lm, 4000K) incl.
IP20
chrome/white



5 362250 124784

2479 (M) (P)

LED / 18W
(1440lm, 4000K) incl.
IP20
chrome/white



5 362250 124791

2481 (M) (P)

LED / 19,2W
(1550lm, 4000K) incl.
IP20
chrome/white



5 362250 124814

2480 (M) (P)

LED / 18W
(1500lm, 4000K) incl.
IP20
chrome/white



5 362250 124807

TEMPERIUS



New



72011

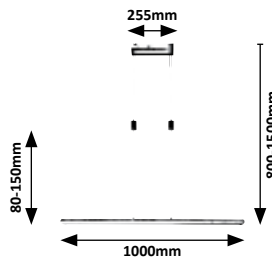

72011

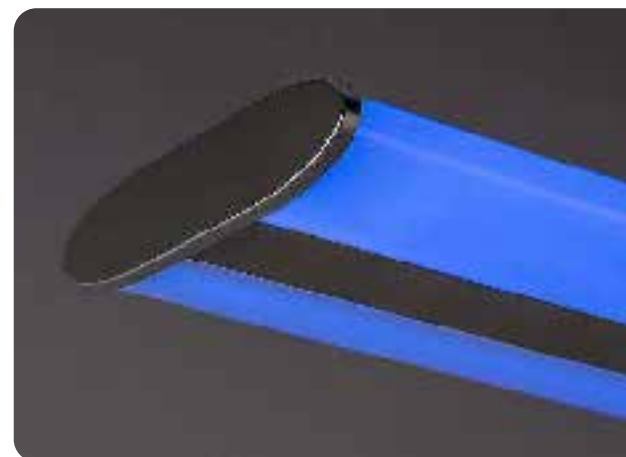
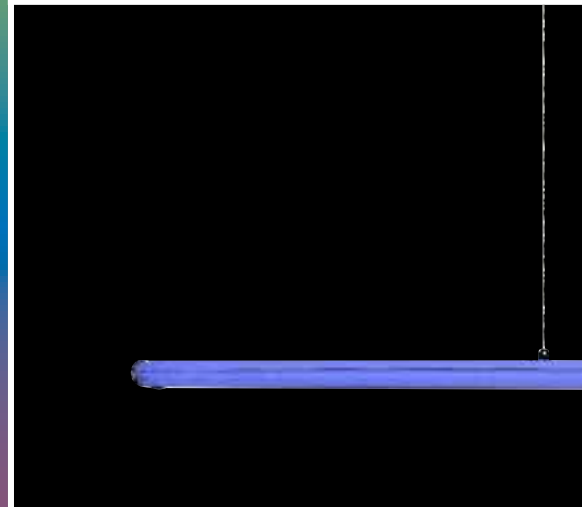
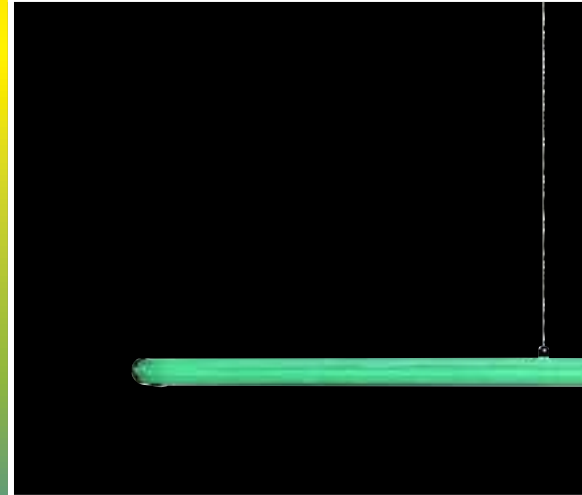
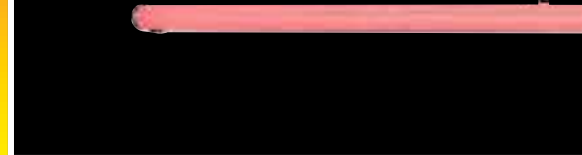

72011

(M) (P)

LED / 24W
 (1415lm, 1950lm;
 3000K) incl. • IP20 • 562
 satin chrome/white



4 742 96 72011 7

EUCALYPTUS



New



2957

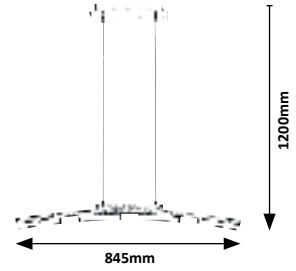

TITHANIA



New



6670

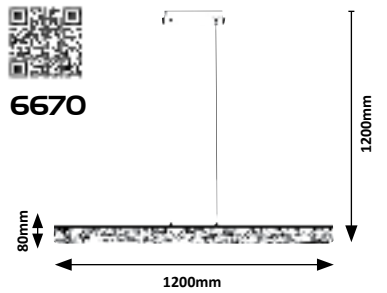

2957 (M) (P)

LED / 20W
(E) 1650lm; (E) 1760lm, 3000K) incl.
IP20
satin chrome/white



5 038253 329574

6670 (M) (P)

LED / 24W
(E) 1920lm, 2700K-6500K) incl.
IP20 • (E)
brushed aluminium/white



5 358294 36670E

YORDANA



New



5280

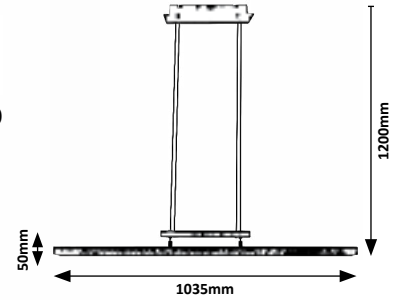

TAMUR



New

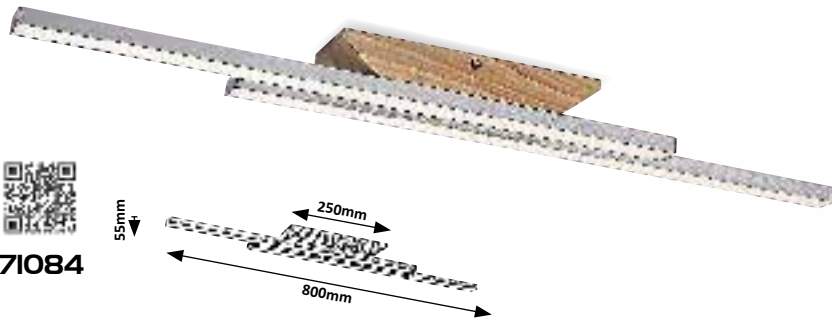

71084

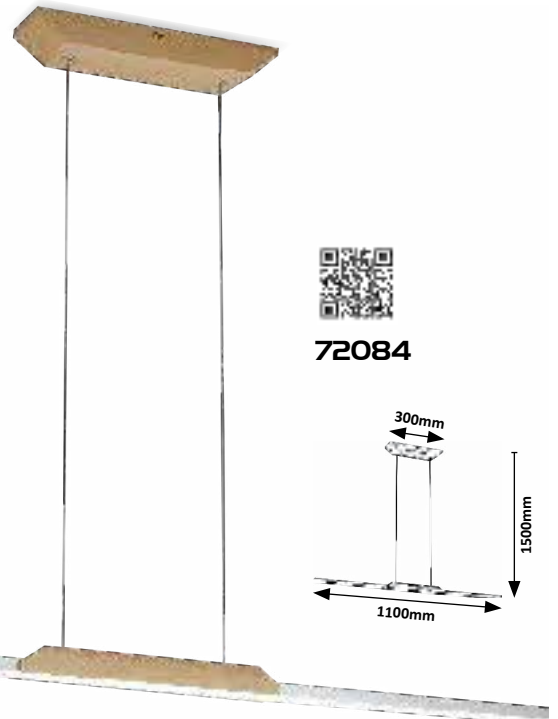

72084

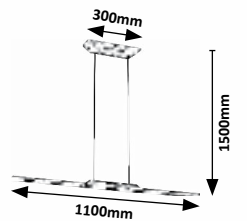

5280 (M) (P)

LED / 27W
 (E) 1800lm; (E) 3300lm, 3000K) incl.
 IP20
 satin chrome/white



71084 (M) (P) (W)

LED / 21W
 (E) 1900lm, (E) 2490lm;
 4000K) incl. • IP20
 beech/brushed aluminium/white



72084 (M) (P) (W)

LED / 26W
 (E) 2250lm, (E) 2830lm;
 4000K) incl. • IP20
 beech/brushed aluminium/white





AISHA

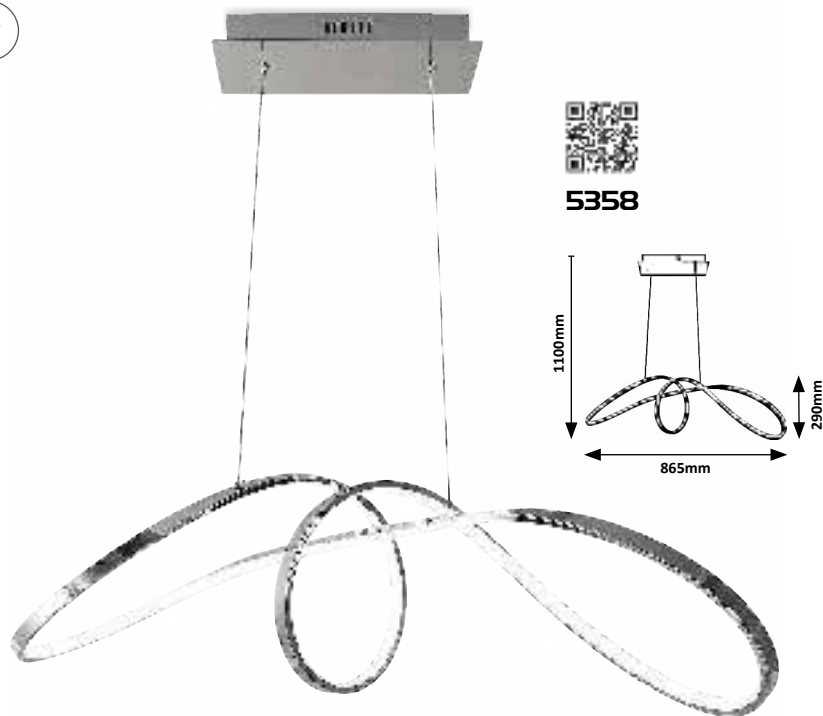

PIERO

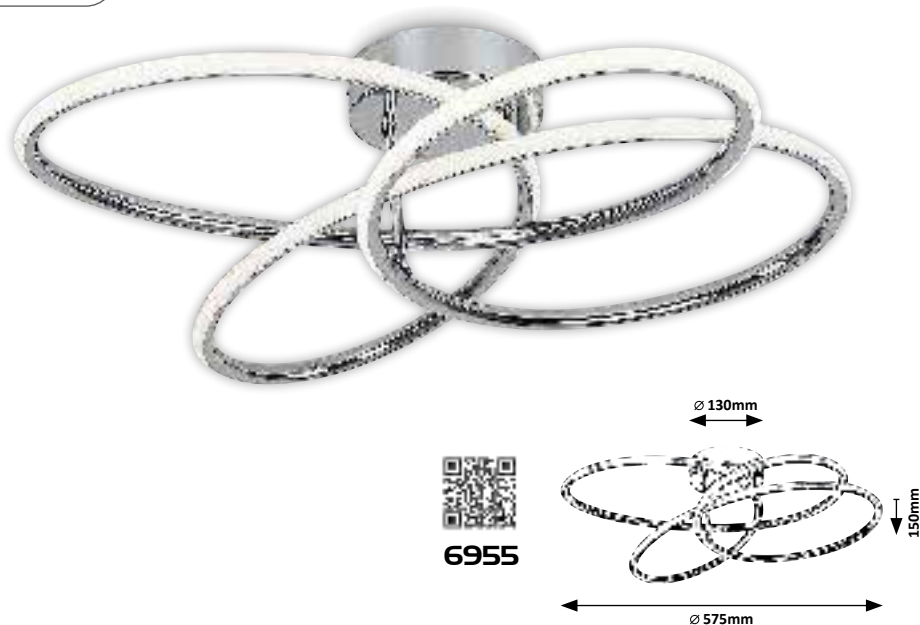

5358 (M) (P)
 LED / 38W
 (E) 2600lm; (E) 4250lm, 4000K) incl.
 IP20
 chrome/white



6955 (M) (P)
 LED / 30W
 (E) 2000lm; (E) 3400lm, 4000K) incl.
 IP20
 chrome/white



ESILDA

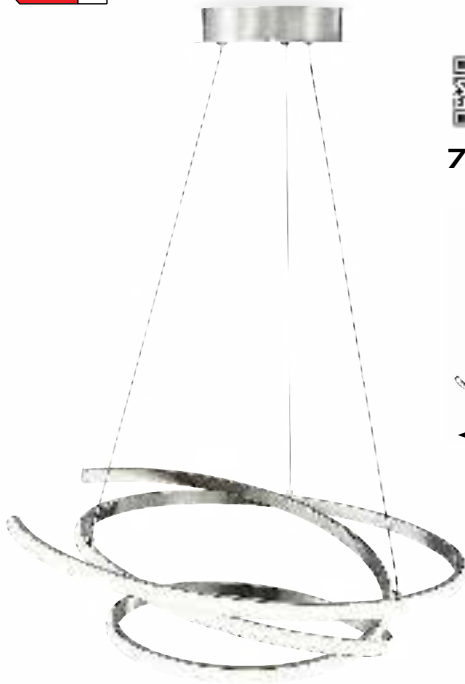

72020

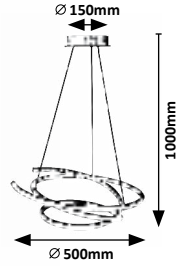

FRINGILLA

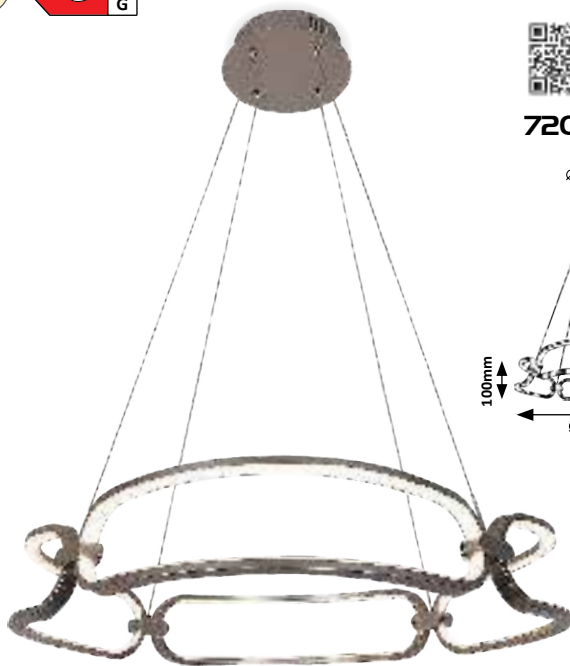

72010

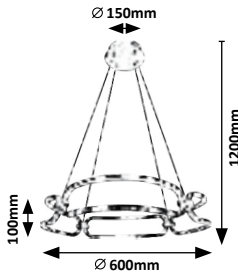

72020 (M) (P)

LED / 42W
 (2200lm, 4150lm;
 4000K) incl. • IP20
 satin chrome/white



72010 (M) (P)

LED / 67W
 (3750lm, 7000lm;
 4000K) incl. • IP20
 satin chrome/white



72009



IRELIA



71008

NATURAL White

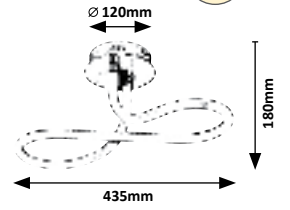

72009

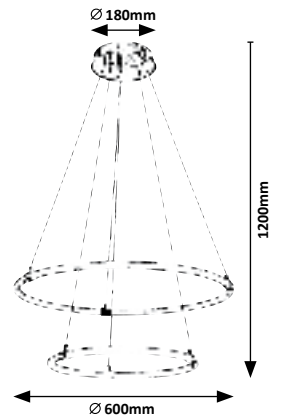

71008 (M) (A)

LED / 23W
(2200lm, 3200lm;
4000K incl. • IP20
satin chrome/white



72009 (M) (A)

LED / 55W (4700lm, 7800lm;
3000k, 4000K, 6000K) incl.
IP20 • 549
satin chrome/white



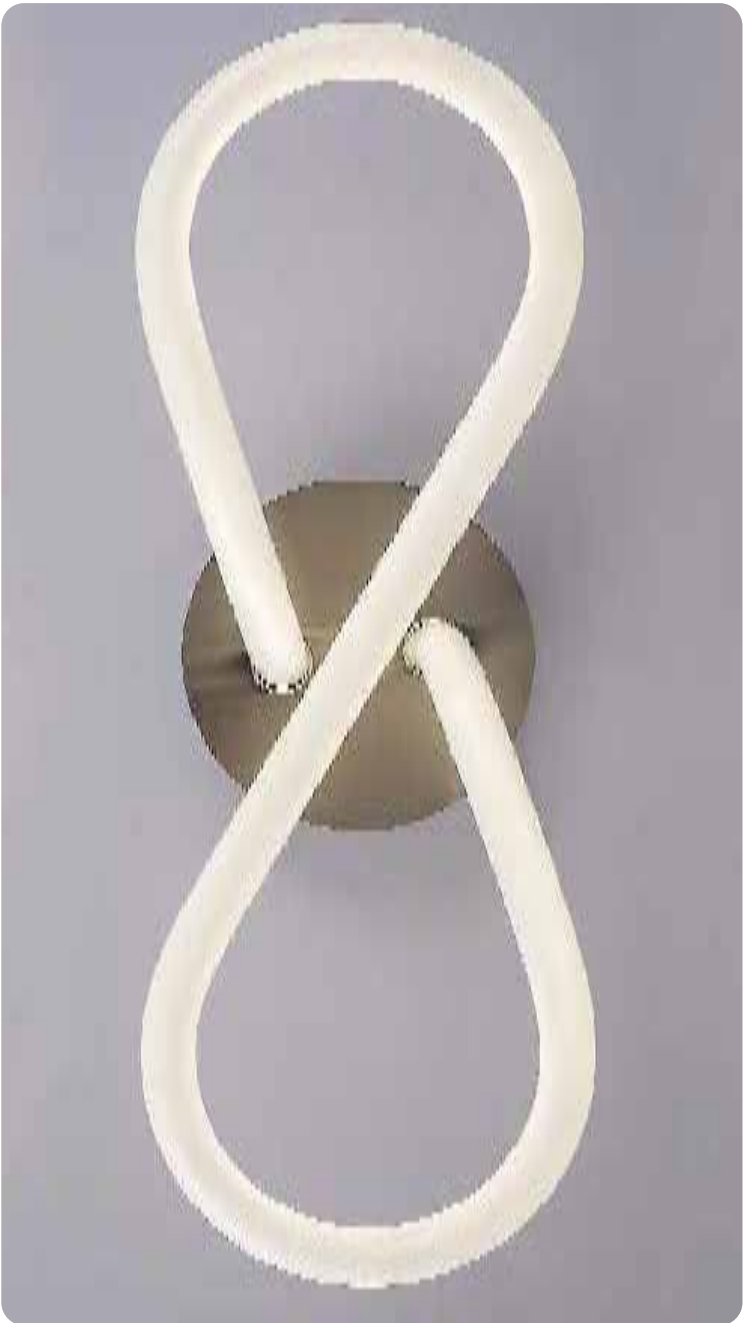
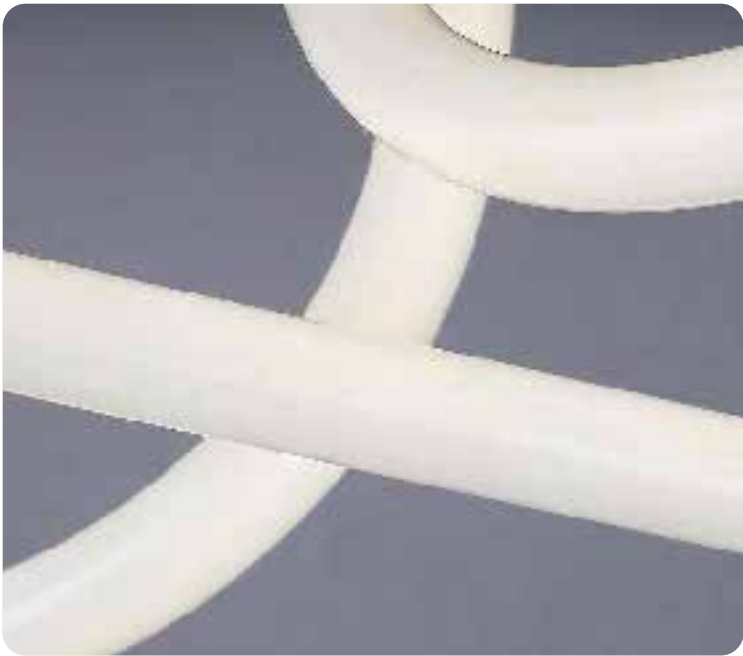



PALMIRA

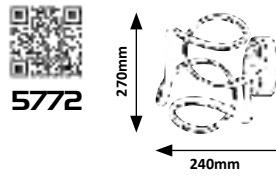

5771

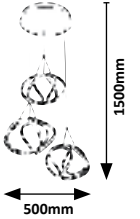

5770

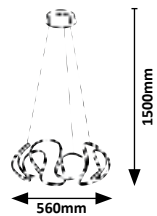

5770 (M) (P)

LED / 38W
(2500lm, 3000K) incl.
IP20
chrome



5771 (M) (P)

LED / 50W
(3400lm, 3000K) incl.
IP20
chrome



5772 (M) (P)

LED / 11W
(700lm, 3000K) incl.
IP20
chrome



AMBROSIO

5 YEAR GUARANTEE

LED built-in

WARM White

G A ↑ G



5693

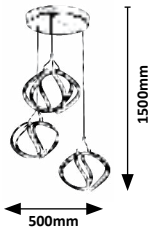

5694

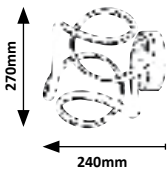

5692

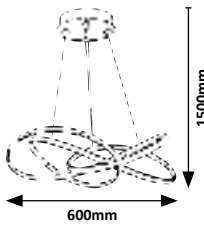

5692 (M) (P)

LED / 40W
(2700lm, 3000K) incl.
IP20
brown



S 398296 250221

5693 (M) (P)

LED / 50W
(3400lm, 3000K) incl.
IP20
brown



S 398296 250222

5694 (M) (P)

LED / 11W
(700lm, 3000K) incl.
IP20
brown



S 398296 250223

TULIO

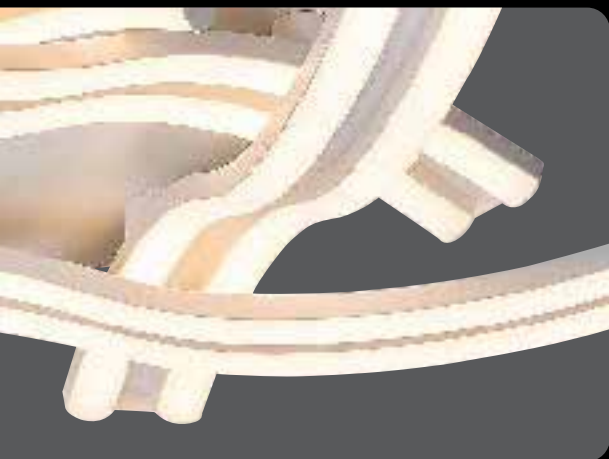

5890



Ø 550mm

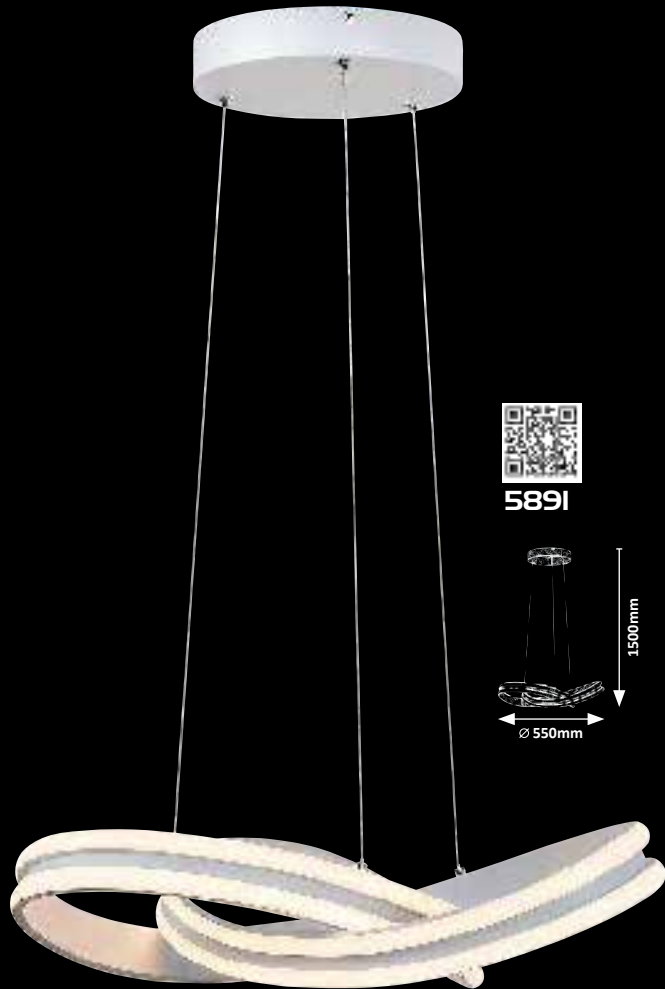

5891

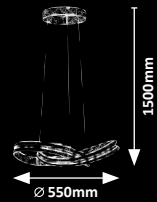

1500mm

Ø 550mm

5890 (M) (P)

LED / 60W
(4000lm, 3000K) incl.
IP20
white



5 362250 755301

5891 (M) (P)

LED / 60W
(3600lm, 3000K) incl.
IP20
white



5 362250 755318

DONATELLA

5
GUARANTEE
YEARS

LED
built-in

NATURAL
White

G
A
↑
G

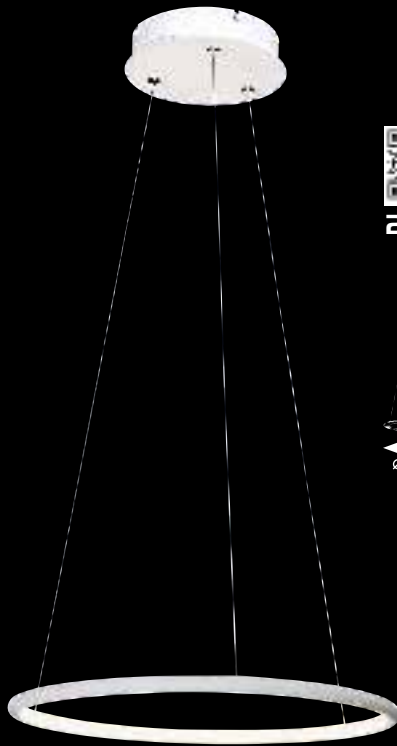

2543

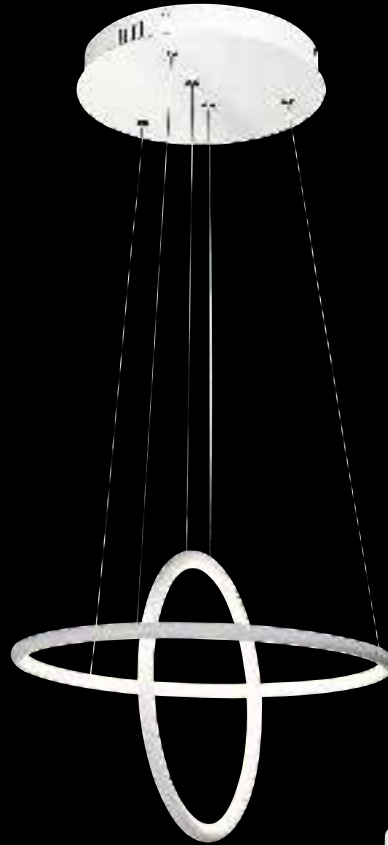
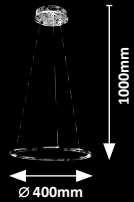

2544

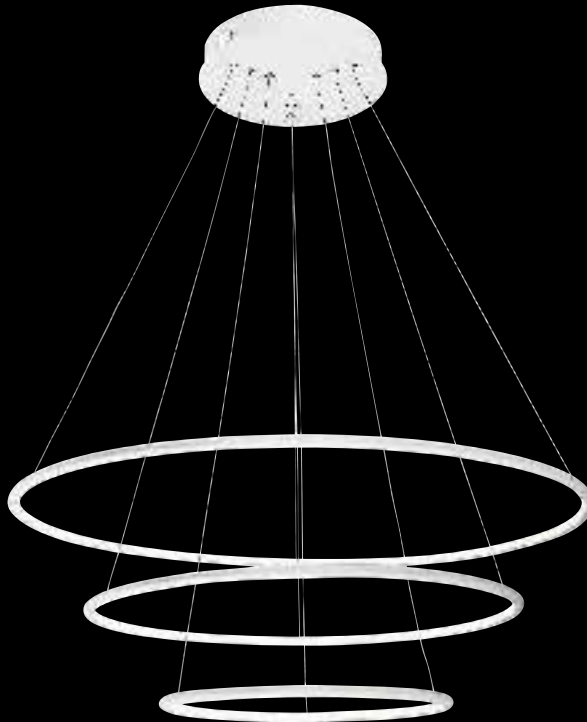
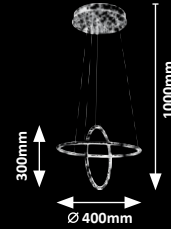

2545

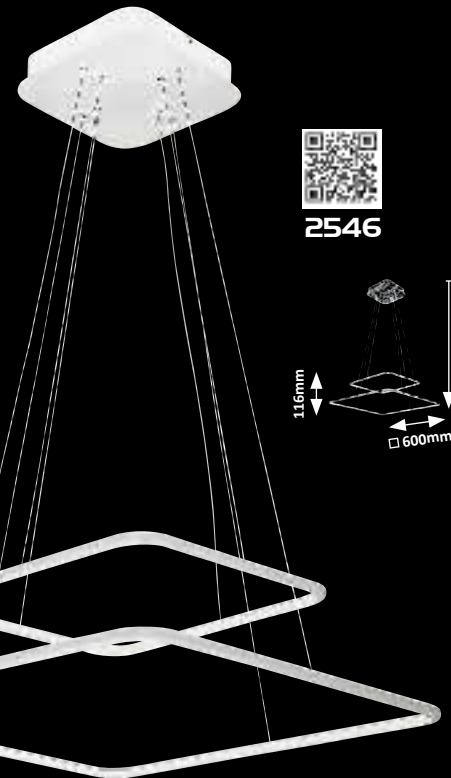
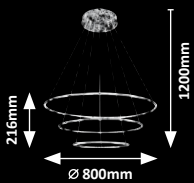

2546

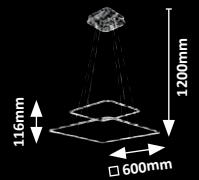

2543 (M) (P)

LED / 21W
(1417lm, 4000K) incl.
IP20
white



5 362250 225430

2544 (M) (P)

LED / 37W
(2300lm, 4000K) incl.
IP20
white



5 362250 225440

2545 (M) (P)

LED / 95W
(5774lm, 4000K) incl.
IP20
white



5 362250 225450

2546 (M) (P)

LED / 65W
(4077lm, 4000K) incl.
IP20
white



5 362250 225460

ADRIENNE

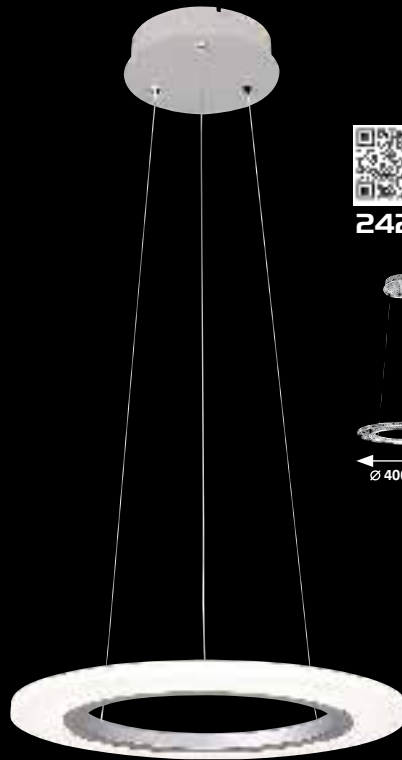

2428

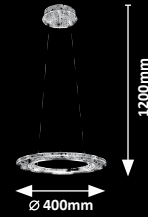

2429

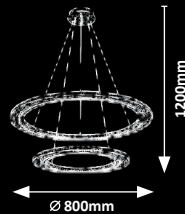

2428 (M) (P)

LED / 15W
(1200lm, 4000K) incl.
IP20
silver/transparent



5 362250 224280

2429 (M) (P)

LED / 62W
(4861lm, 4000K) incl.
IP20
silver/transparent



5 362250 224290

ANIELA



2187

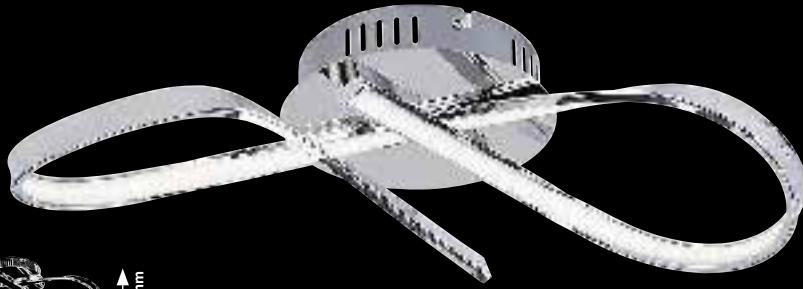
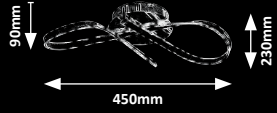

2188

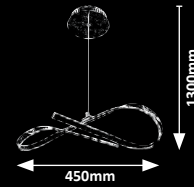

2187



LED / 20W
(1600lm, 4000K) incl.
IP20
chrome



5 362250 321873

2188



LED / 20W
(1600lm, 4000K) incl.
IP20
chrome



5 362250 321882





ROXANA



6830

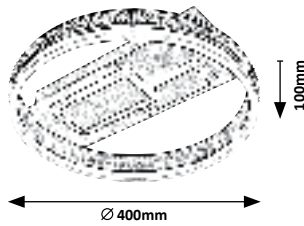

6830 (MA)

LED / 50W
(2450lm, 4000K) incl.
IP20
silver/white



AVALON



2229

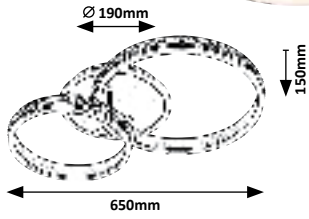

2230

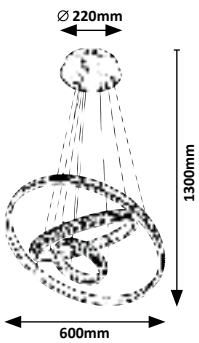
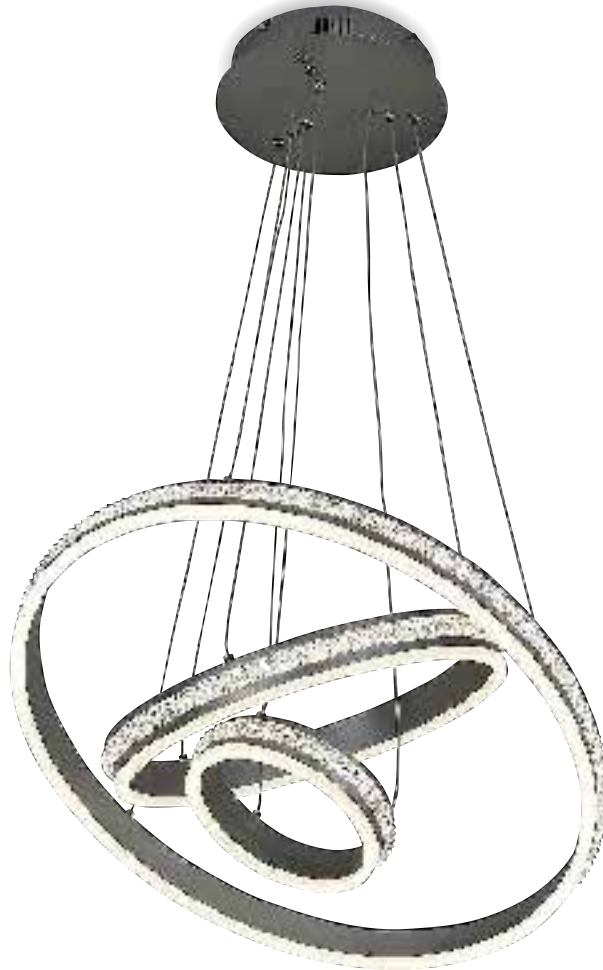

2229



LED / 50W
(3150lm, 4000K) incl.
IP20
brushed aluminium/white



5 362250 222292

2230



LED / 75W
(4730lm, 4000K) incl.
IP20
brushed aluminium/white



5 362250 222302



WILLOW



6969

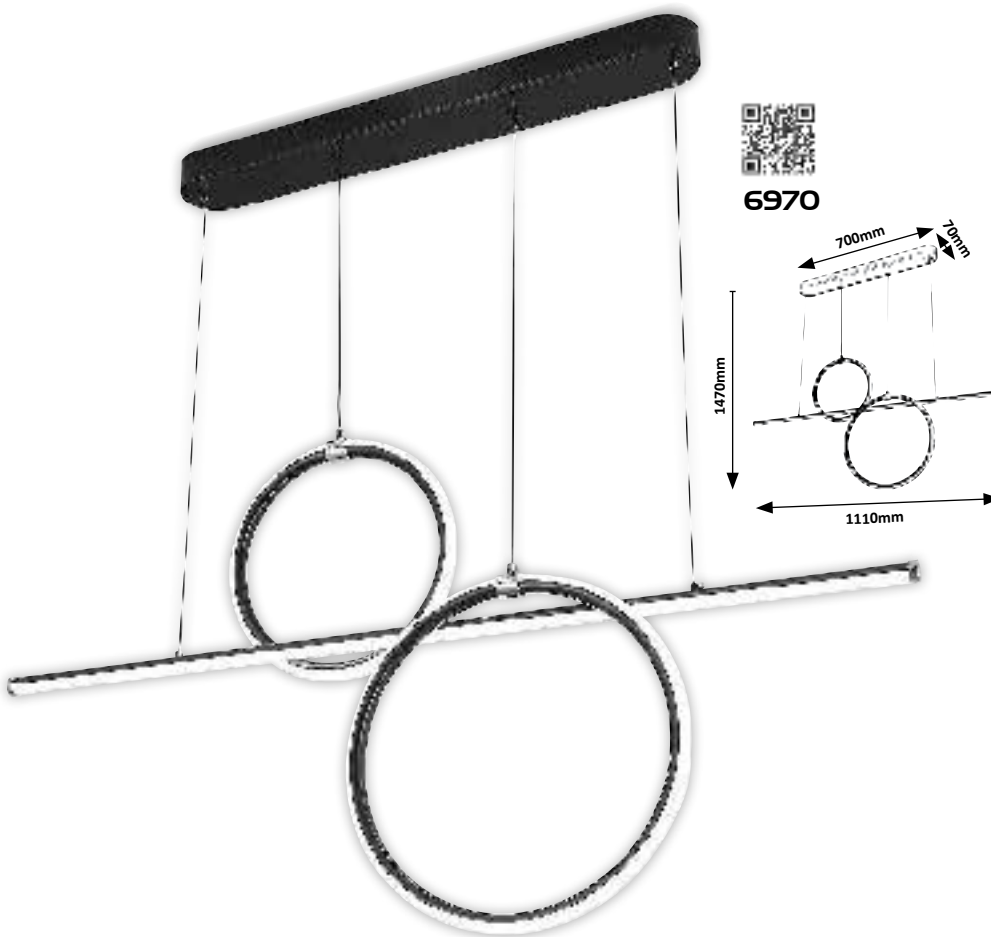
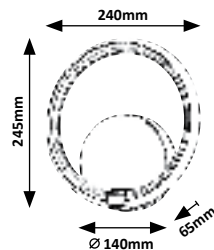

6970

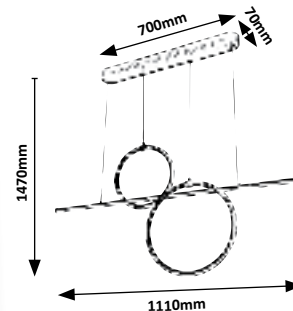

6969 (M) (P)

LED / 12W
(750lm, 4000K) incl.
IP20
matte black/white/chrome



S 36225C 363293

6970 (M) (P)

LED / 48W
(2760lm, 4000K) incl.
IP20
matte black/white/chrome



S 36225C 363700

RIVER

5
YEAR
WARRANTY

LED
built-in

NATURAL
White

G A
↑ G

New



6899

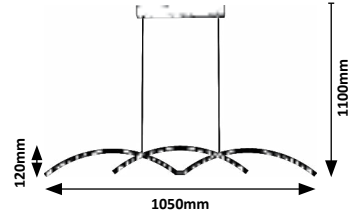

6899

(M) (P)

LED / 40W

(20) 2000lm; (35) 3500lm, 4000K incl.

IP20

black/white



5 908253 348621



MERIDIA



3256

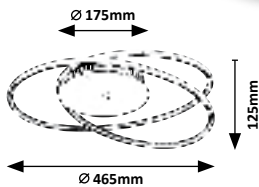

3257

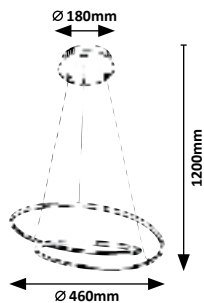

3256 (M P)

LED / 40W
(2900lm, 3000K) incl.
IP20
matte black/white

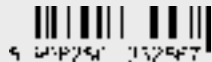

4 242751 132576

3257 (M P)

LED / 40W
(2900lm, 3000K) incl.
IP20
matte black/white



4 242751 132577

SHIENA

5 YEARS GUARANTEE

LED built-in

NATURAL White

G A ↑ G

New



7116

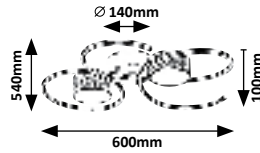

SABIRA

5 YEARS GUARANTEE

LED built-in

NATURAL White

G A ↑ G

New



7112

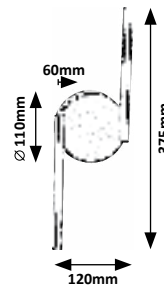

7116 M P T

LED / 38W
(1880lm, 3300lm;
4000K) incl. • IP20
matte black/grey

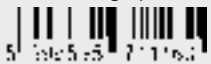

7112 M P

LED / 8W
(340lm, 790lm;
4000K) incl. • IP20
black/white



7112



RONNO



74050

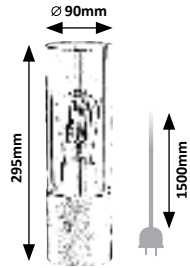

72051

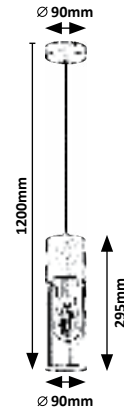

72053

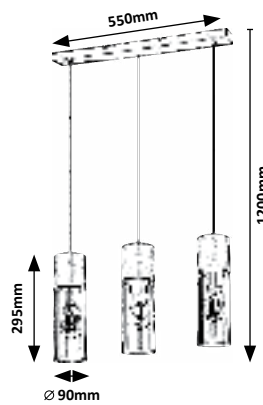

72054

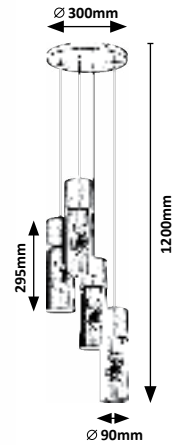

74050 (M) (G)

☒ E27 / 1x max. 25W
IP20 • 19516 • black/tinted colour



72051 (M) (G)

☒ E27 / 1x max. 25W
IP20 • 19516 • black/tinted colour



72053 (M) (G)

☒ E27 / 3x max. 25W
IP20 • 19516 • black/tinted colour



72054 (M) (G)

☒ E27 / 4x max. 25W
IP20 • 19516 • black/tinted colour



CHADWICK

New

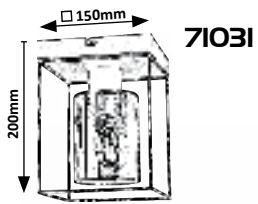

71034

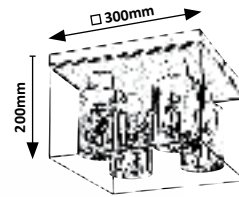

72033

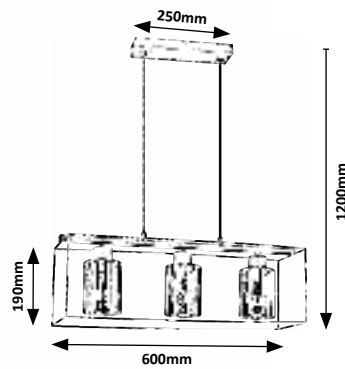

71031 (M) (G)

⊗ E27 / 1x max. 25W
IP20 • 19512
black/tinted colour



71034 (M) (G)

⊗ E27 / 4x max. 25W
IP20 • 19512
black/tinted colour



72033 (M) (G)

⊗ E27 / 3x max. 25W
IP20 • 19512
black/tinted colour





LISSANDRA

TEXTILE
CABLE

2000

New



72101

Ø 120mm

2100mm

Ø 215mm



72103

Ø 395mm

2100mm

Ø 215mm

72101 **MG**

☒ E27 / 1x max. 40W
IP20 • 19936
matte black/tinted colour



4 843506 72101 5

72103 **MG**

☒ E27 / 3x max. 40W
IP20 • 19936, 19940
matte black/tinted colour



4 843506 72103 4

DVORA

New

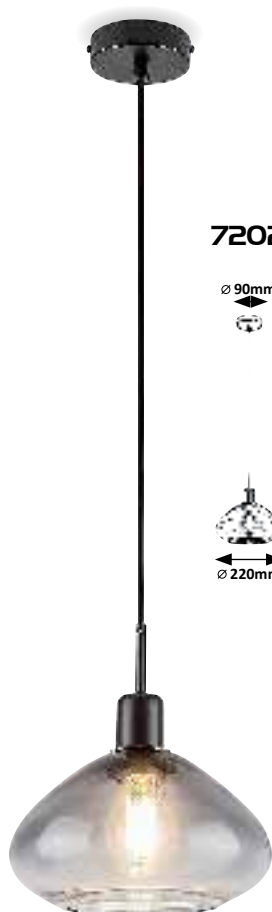

72021

∅ 90mm



1500mm

∅ 220mm



72023

∅ 300mm



1500mm

∅ 220mm



72021 **M G**

☒ E27 / 1x max. 40W
IP20 • 19444
matte black/tinted colour



405696 72021

72023 **M G**

☒ E27 / 3x max. 40W
IP20 • 19444, 19445
matte black/tinted colour/
transparent



405696 72023





SHEILA

TEXTILE
CABLE

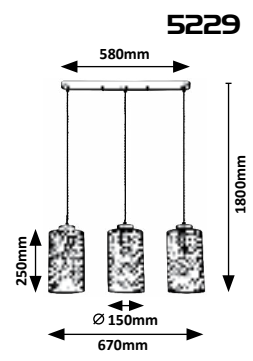
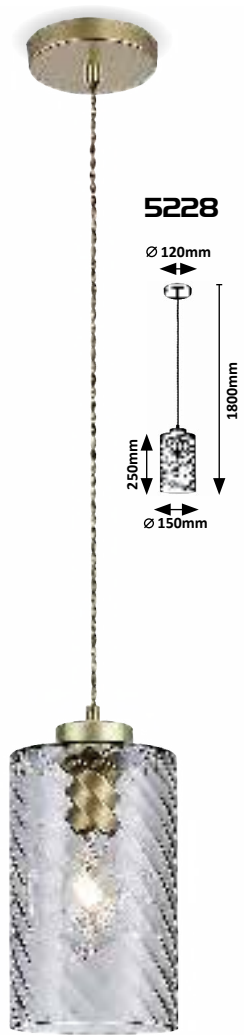

5228 **MG**
 ☒ E27 / 1x max. 40W
 IP20 • 19932
 tinted colour/gold



5229 **MG**
 ☒ E27 / 3x max. 40W
 IP20 • 19932
 tinted colour/gold



MONET



74017

Ø 190mm



200mm

1200mm

New



TEXTILE CABLE

3177

Ø 120mm

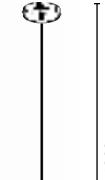

1900mm

Ø 235mm

TEXTILE CABLE

3178

Ø 455mm

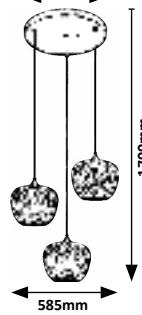

1700mm

585mm



3177 (M) (G)

⊠ E27 / 1x max. 40W
IP20 • 19976
chrome/tinted colour



5 362250 33 773

3178 (M) (G)

⊠ E27 / 3x max. 40W
IP20 • 19976
chrome/tinted colour



5 362250 33 782

74017 (M) (G)

⊠ E27 / 1x max. 40W
IP20 • 19985
chrome/tinted colour



5 476294 24 7177

SULLIVAN

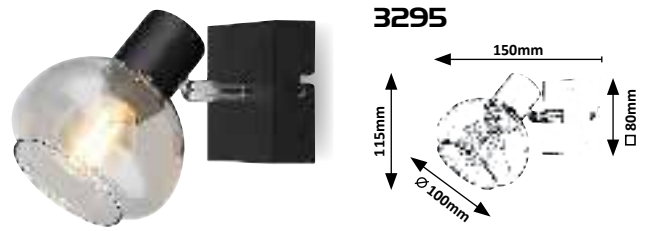

3295 **MG**

☒ E14 / 1x max. 40W
IP20 • 19951
black/tinted colour



3296 **MG**

☒ E14 / 5x max. 40W
IP20 • 19951
black/tinted colour



3297 **MG**

☒ E14 / 5x max. 40W
IP20 • 19951
black/tinted colour



GLORY

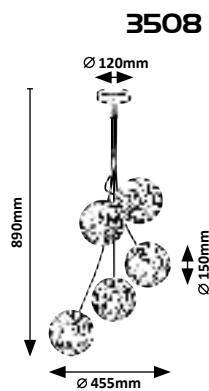

3508 **MG**

☒ E14 / 5x max. 40W
IP20 • 19603
matte black/tinted colour





PETUNIA

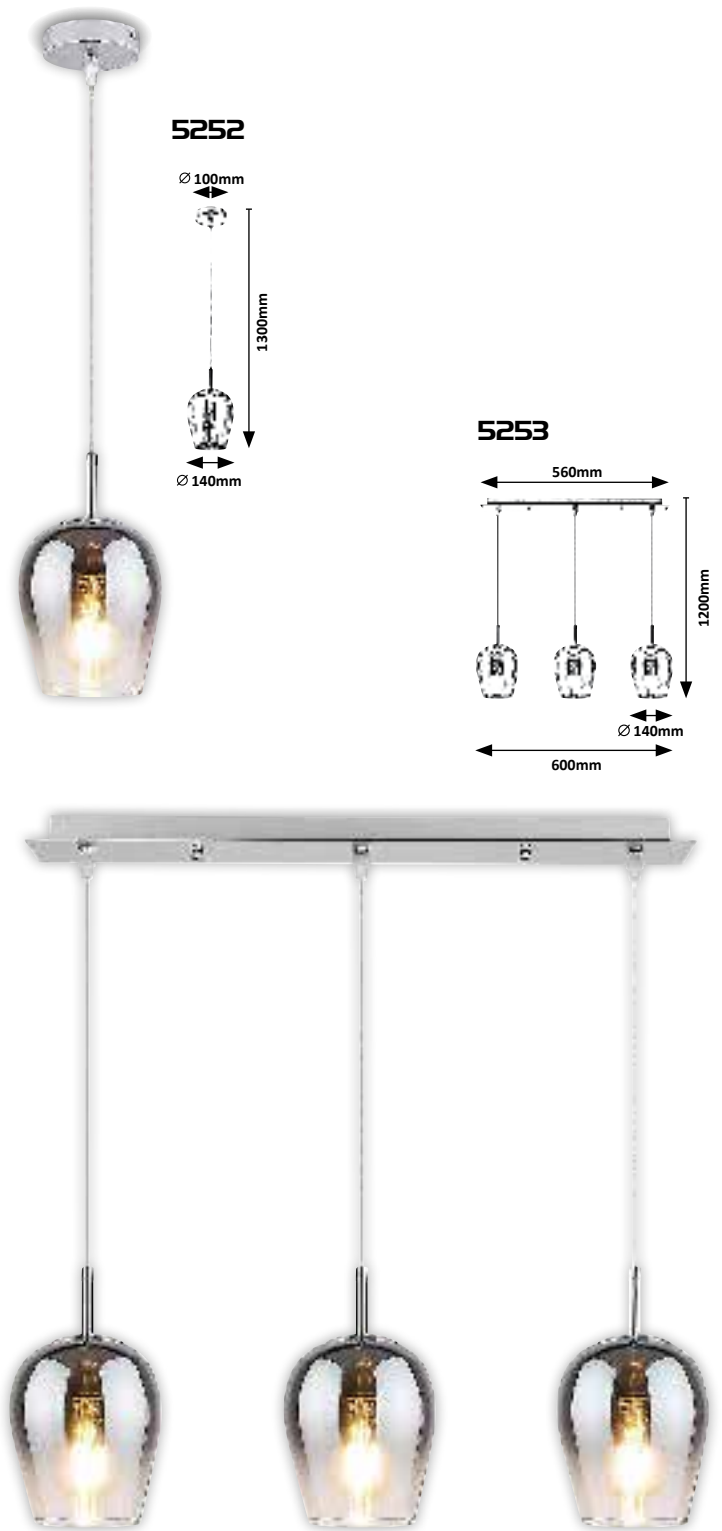

5252 (M) (G)

☒ E27 / 1x max. 15W
 IP20 • 19944
 chrome/tinted glass



5253 (M) (G)

☒ E27 / 3x max. 15W
 IP20 • 19944
 chrome/tinted glass



DONATI

151. Others / Best match



5248

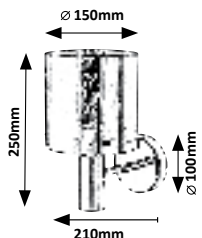

5249

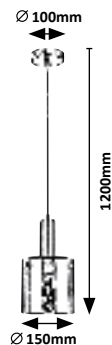

5251



5250

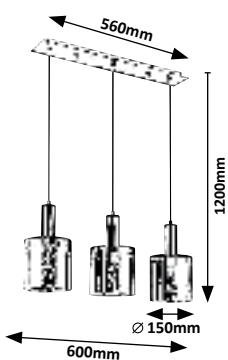

5248 (M) (G)

☒ E27 / 1x max. 60W
IP20
☑ 19943
chrome/tinted colour

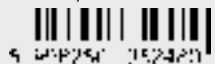

5249 (M) (G)

☒ E27 / 1x max. 60W
IP20
☑ 19943
chrome/tinted colour

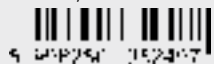

5250 (M) (G)

☒ E27 / 3x max. 60W
IP20
☑ 19943
chrome/tinted colour

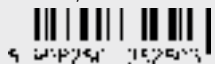

5251 (M) (G)

☒ E27 / 5x max. 60W
IP20
☑ 19943
chrome/tinted colour



TANNO



74120

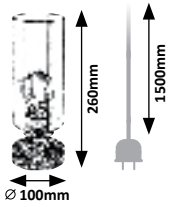

TEXTILE
CABLE
72141

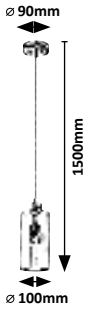

TEXTILE
CABLE
72123

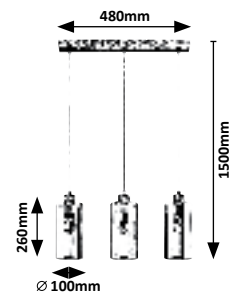

72123 **MG**

☒ E27 / 3x max. 25W
IP20 • 19981
oak/tinted colour



72141 **MG**

☒ E27 / 1x max. 25W
IP20 • 19981
oak/tinted colour



74120 **MG**

☒ E27 / 1x max. 25W
IP20 • 19981 • 19982
oak/tinted colour



TANNO

TEXTILE
CABLE

2000
1657

New

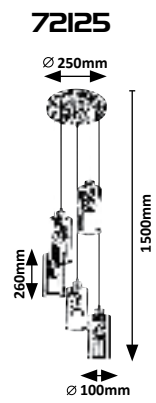

72125 M G

☒ E27 / 5x max. 25W
IP20 • 19981
oak/tinted colour



CARDAMOM

WOOD



3081

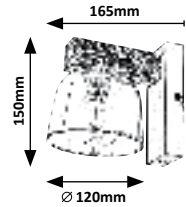

3119

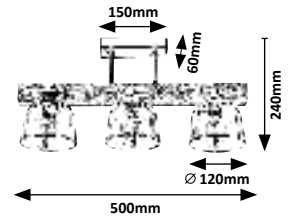

3118

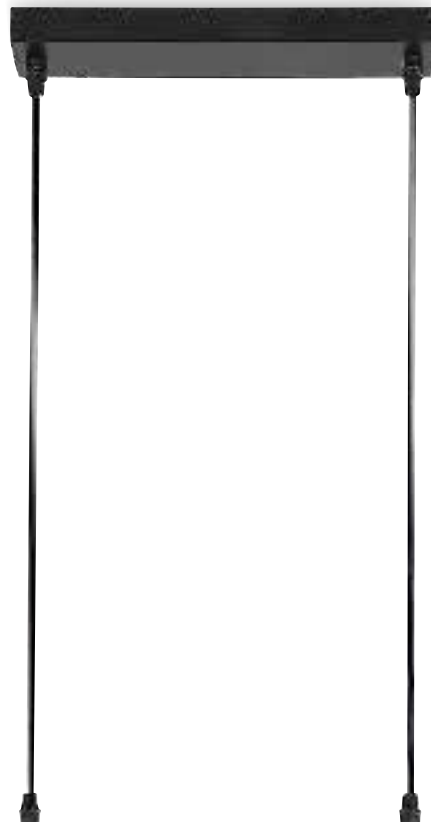
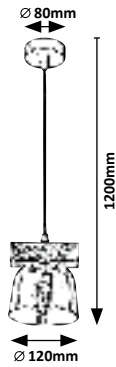

3120

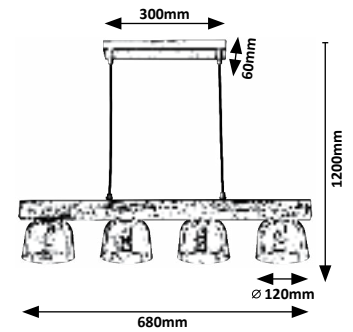

3081 M G W

☒ E14 / 1x max. 40W
IP20 • 19977 • 19977
matte black/silver oak/tinted colour



3118 M G W

☒ E14 / 1x max. 40W
IP20 • 19977 • 19977
matte black/silver oak/tinted colour



3119 M G W

☒ E14 / 3x max. 40W
IP20 • 19977 • 19977
matte black/silver oak/tinted colour



3120 M G W

☒ E14 / 4x max. 40W
IP20 • 19977 • 19977
matte black/silver oak/tinted colour



PEYTON

TEXTILE
CABLE

WOOD

New

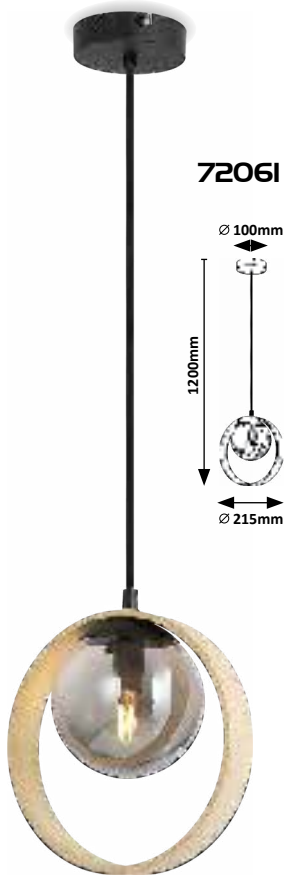

72061

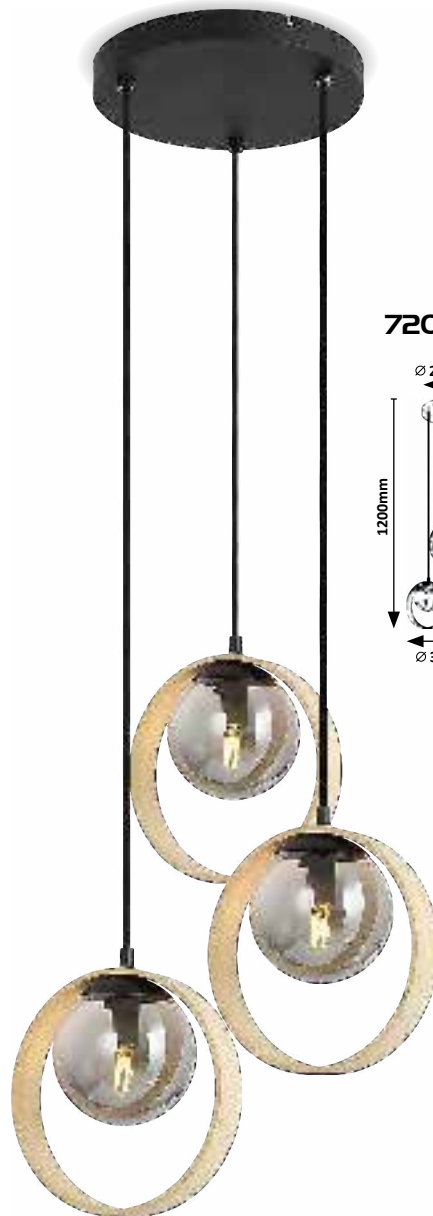
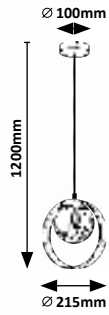

72063

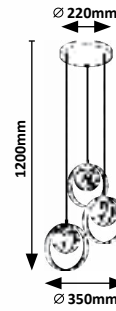

72061 M W G

☒ E14 / 1x max. 15W
IP20 • 19514
beech/tinted colour



72063 M W G

☒ E14 / 3x max. 15W
IP20 • 19514
beech/tinted colour



NIYLAH

WOOD

New



71080

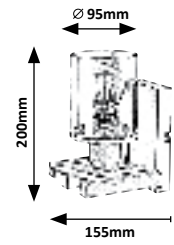

71083

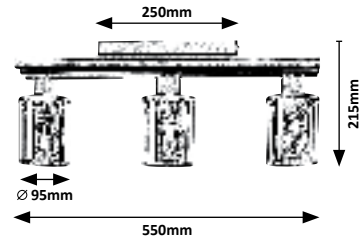

72081

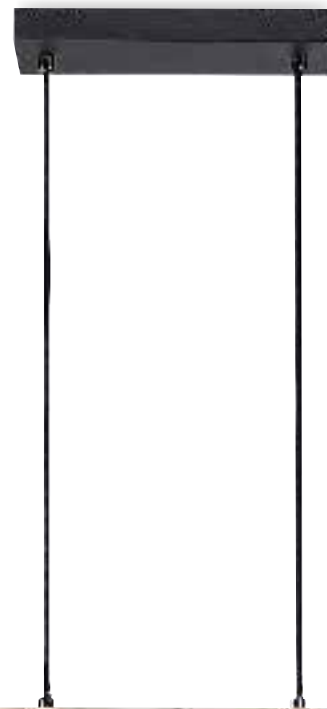
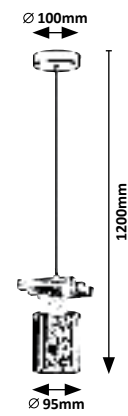

72083

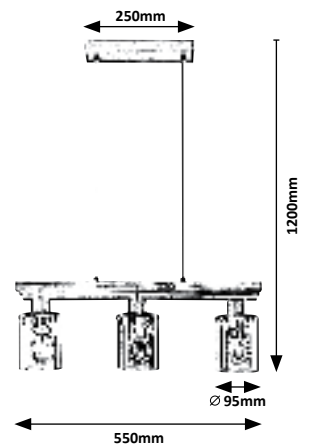

71080 M G W

☒ E27 / 1x max. 25W
IP20 • 19566
black/amber



71083 M G W

☒ E27 / 3x max. 25W
IP20 • 19566
black/amber



72081 M G W

☒ E27 / 1x max. 25W
IP20 • 19566
black/amber



72083 M G W

☒ E27 / 3x max. 25W
IP20 • 19566
black/amber





ZENAIDA



3545



Ø 400mm

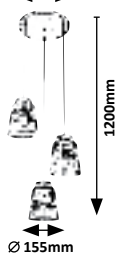

3542

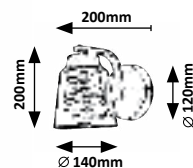

3543



Ø 90mm

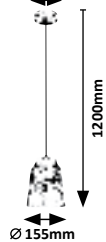

3544

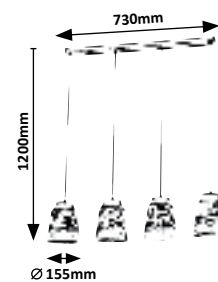

3542 (M) (G)

⊗ E27 / 1x max. 60W
IP20 • 19920
matte black/gold/transparent

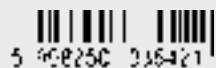

3543 (M) (G)

⊗ E27 / 1x max. 60W
IP20 • 19921
matte black/gold/transparent



3544 (M) (G)

⊗ E27 / 4x max. 60W
IP20 • 19921
matte black/gold/transparent



3545 (M) (G)

⊗ E27 / 3x max. 60W
IP20 • 19921
matte black/gold/transparent



DONATI

143. Others / Best match

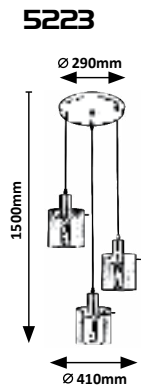
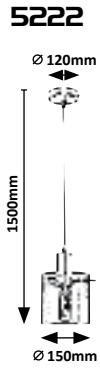
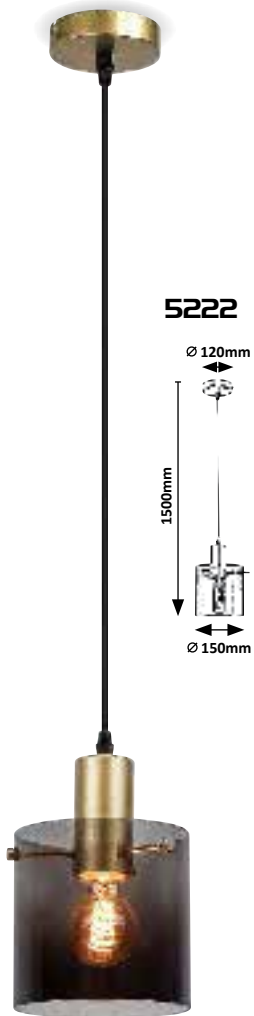

3543



5222



5222 **MG**

☒ E27 / 1x max. 40W
IP20 • 19926
tinted colour/gold



5 958253 3 2226

5223 **MG**

☒ E27 / 3x max. 40W
IP20 • 19926
tinted colour/gold



5 958253 3 2227



URSULA

 **New**



3189

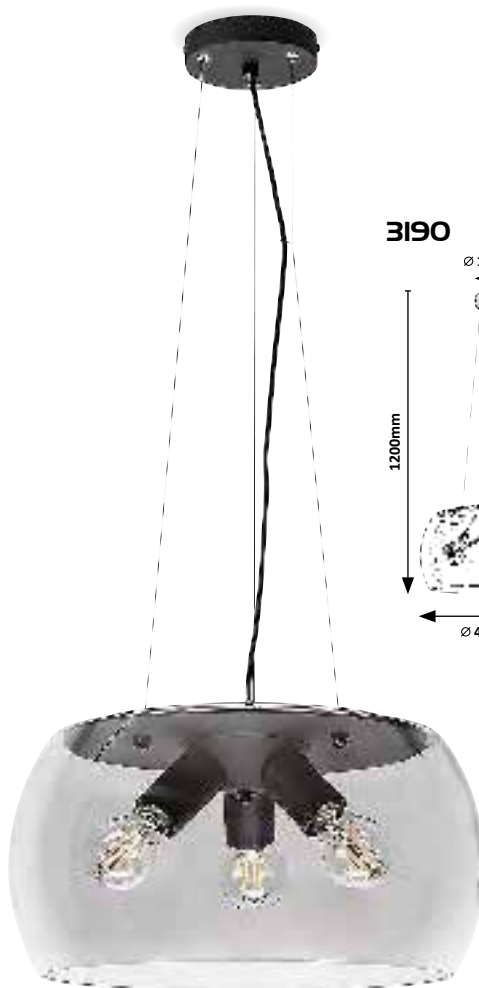
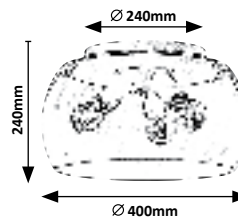

3190

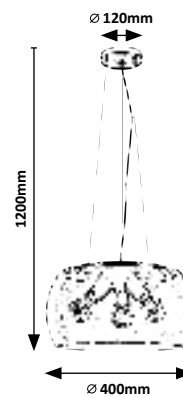

3189 **M G**

☒ E27 / 3x max. 40W
IP20
▣ 19644
black/tinted colour



3190 **M G**

☒ E27 / 3x max. 40W
IP20
▣ 19644
black/tinted colour



ACANTHA

New

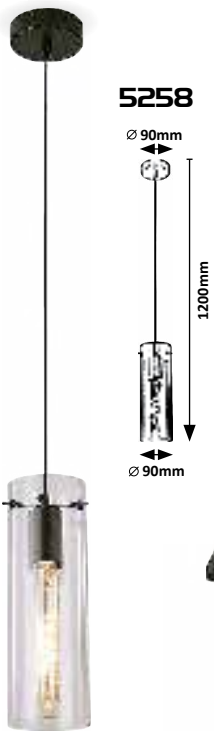

5258

∅ 90mm

1200mm

∅ 90mm



5260

∅ 300mm

1200mm

∅ 90mm

∅ 350mm

5259

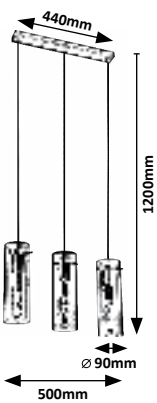

440mm

1200mm

∅ 90mm

500mm

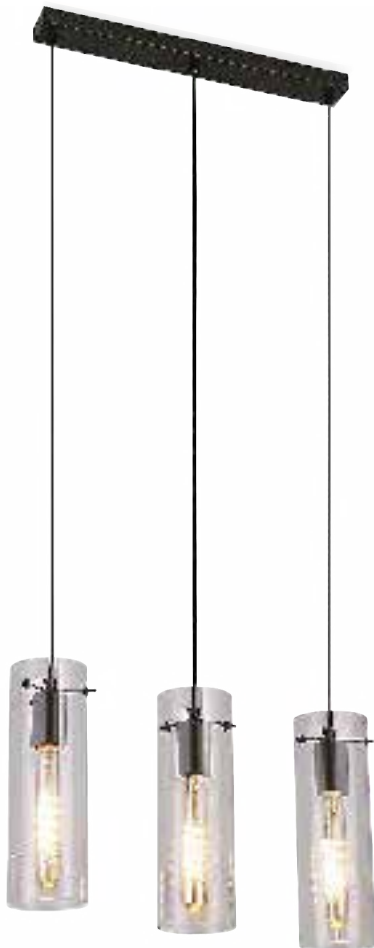

5258 (M) (G)

☒ E27 / 1x max. 40W
IP20
☑ 19611
black/transparent

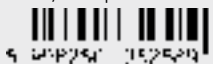

9 882751 152589

5259 (M) (G)

☒ E27 / 3x max. 40W
IP20
☑ 19611
black/transparent

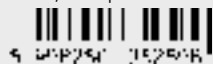

9 882751 152589

5260 (M) (G)

☒ E27 / 5x max. 60W
IP20
☑ 19611
black/transparent

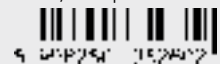

9 882751 152609

PRUDENCE

 **New**

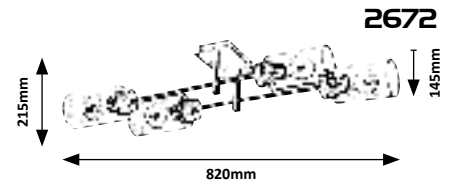
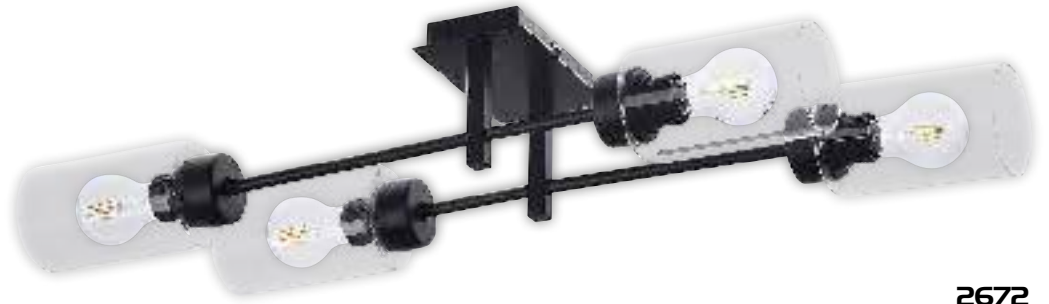
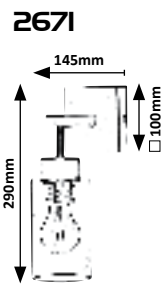

2671

MG

⊠ E27 / 1x max. 40W
IP20
▲ 19778
black/transparent



2672

MG

⊠ E27 / 4x max. 40W
IP20
▲ 19778
black/transparent



MIROSLAW



3579

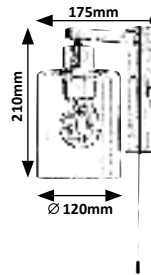

5077

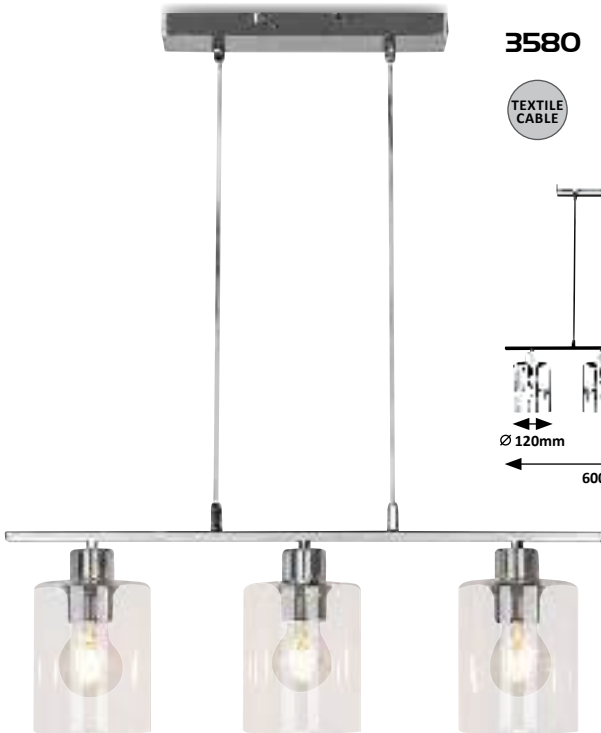
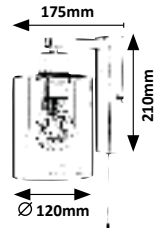

3580

TEXTILE CABLE

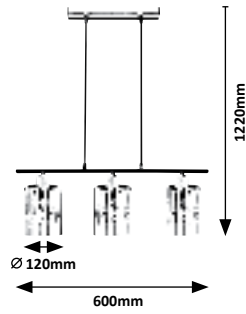

5078

TEXTILE CABLE

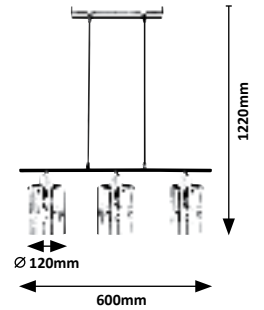

3579 (M) (G)

☒ E27 / 1x max. 40W
IP20 • 19838
satin chrome/transparent



3580 (M) (G)

☒ E27 / 3x max. 40W
IP20 • 19838
satin chrome/transparent



5077 (M) (G)

☒ E27 / 1x max. 40W
IP20 • 19838
matte black/transparent



5078 (M) (G)

☒ E27 / 3x max. 40W
IP20 • 19838
matte black/transparent

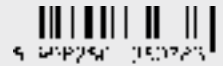



ZELKOVA

TEXTILE
CABLE

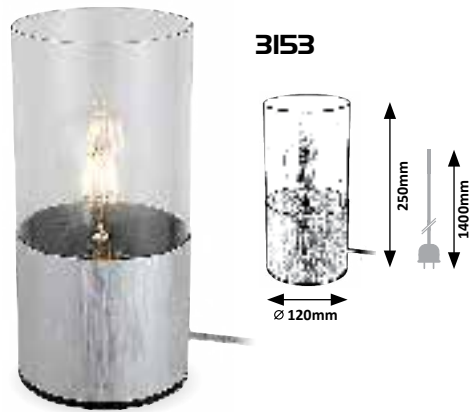

3153

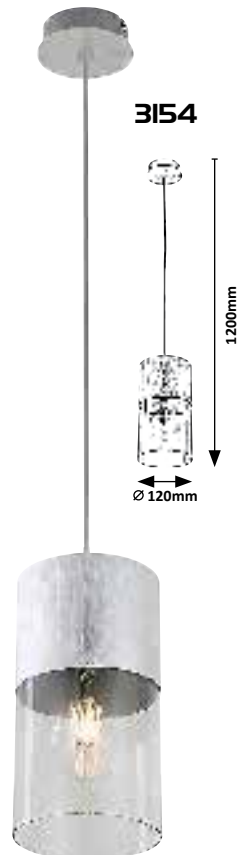

3154



3155

3153 **MG**

☒ E27 / 1x max. 40W
IP20 • 19952 •
brushed aluminium/transparent



5 392260 33530

3154 **MG**

☒ E27 / 1x max. 40W
IP20 • 19952
brushed aluminium/transparent



5 392260 33540

3155 **MG**

☒ E27 / 3x max. 40W
IP20 • 19952
brushed aluminium/transparent



5 392260 33553

ZELKOVA

TEXTILE
CABLE

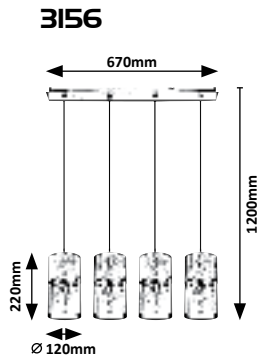

SHIVANI

New

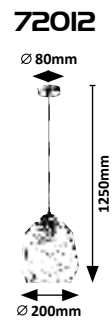
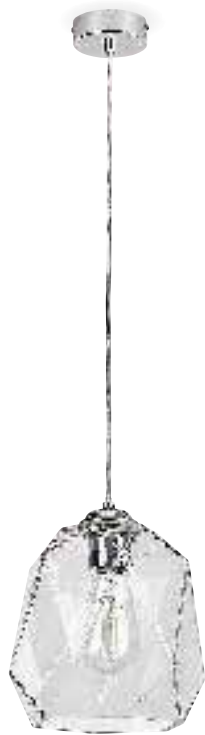

3156 **MG**

☒ E27 / 4x max. 40W
IP20 • 19952
brushed aluminium/transparent



72012 **MG**

☒ E27 / 1x max. 40W
IP20 • 19366
chrome/transparent





HOLLY

Others / Best match
82, 160.



5555

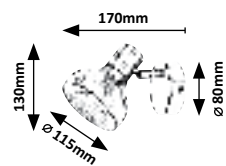

5556

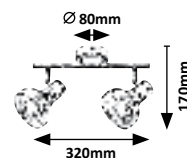

5558

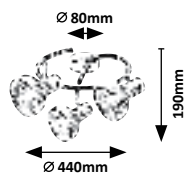

5559

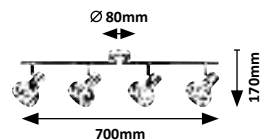

5555 **M G**

☒ E14 / 1x max. 40W
IP20 • 19270
chrome/tinted colour



5556 **M G**

☒ E14 / 2x max. 40W
IP20 • 19270
chrome/tinted colour



5558 **M G**

☒ E14 / 3x max. 40W
IP20 • 19270
chrome/tinted colour



5559 **M G**

☒ E14 / 4x max. 40W
IP20 • 19270
chrome/tinted colour



HOLLY

Others / Best match

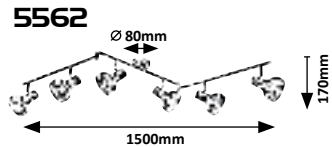
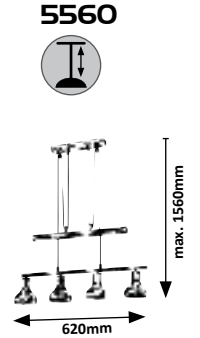
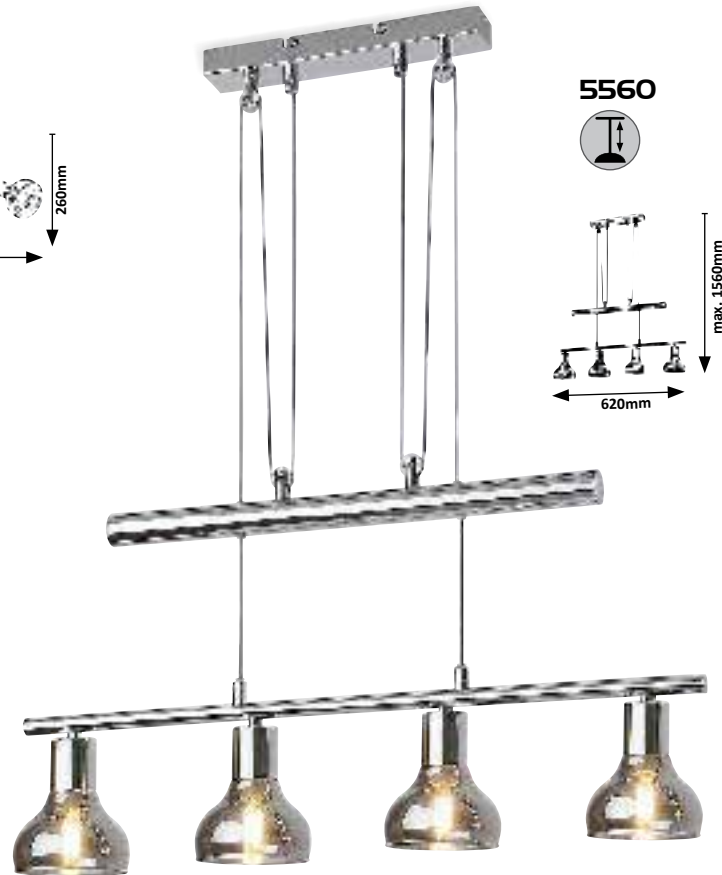
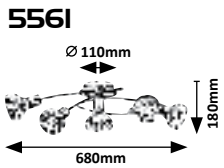
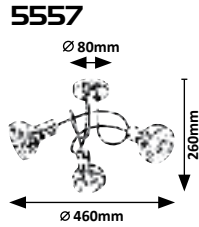

5557 (M) (G)

☒ E14 / 3x max. 40W
IP20 • 19270
chrome/tinted colour



S 36225C 355573

5560 (M) (G)

☒ E14 / 4x max. 40W
IP20 • 19270
chrome/tinted colour



S 36225C 355603

5561 (M) (G)

☒ E14 / 5x max. 40W
IP20 • 19270
chrome/tinted colour



S 36225C 355613

5562 (M) (G)

☒ E14 / 6x max. 40W
IP20 • 19270
chrome/tinted colour



S 36225C 355623

HOLLY

Others / Best match
82, 158



5546

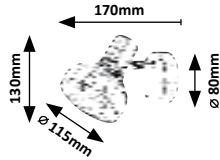

5547

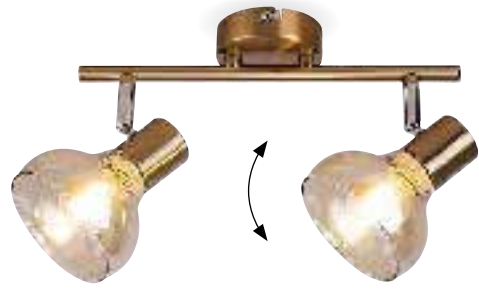
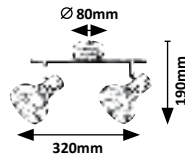

5548

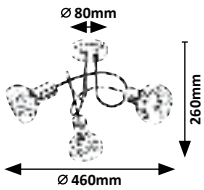

5549

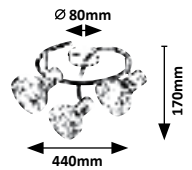

5550

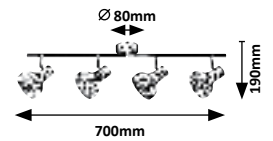

5552

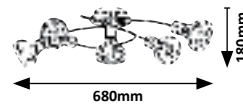

5546 MG

☒ E14 / 1x max. 40W
IP20 • 19269
antique gold/amber



5547 MG

☒ E14 / 2x max. 40W
IP20 • 19269
antique gold/amber



5548 MG

☒ E14 / 3x max. 40W
IP20 • 19269
antique gold/amber



5549 MG

☒ E14 / 3x max. 40W
IP20 • 19269
antique gold/amber



5550 MG

☒ E14 / 4x max. 40W
IP20 • 19269
antique gold/amber



5552 MG

☒ E14 / 5x max. 40W
IP20 • 19269
antique gold/amber



HOLLY

Others /
80, 156. Best match



5553

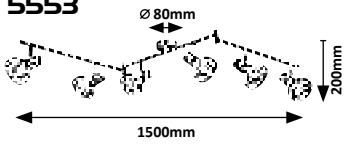

5551

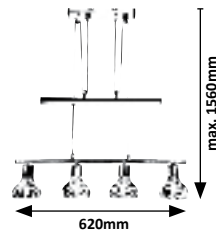

5551 **M G**

☒ E14 / 4x max. 40W
IP20 • 19269
antique gold/amber



5553 **M G**

☒ E14 / 6x max. 40W
IP20 • 19269
antique gold/amber





JEZABEL

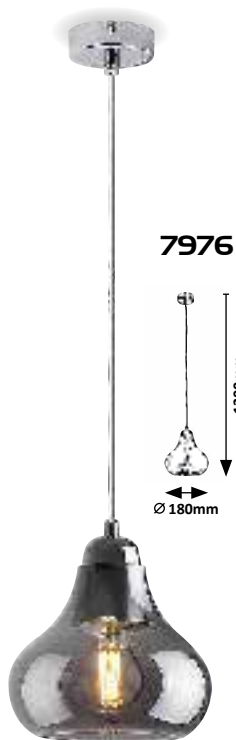

7976 **MG**

☒ E27 / 1x max. 60W
IP20 • 19659
chrome/tinted colour



7977 **MG**

☒ E27 / 3x max. 60W
IP20
19659, 19660, 19661
chrome/tinted colour/transparent/amber



7978 **MG**

☒ E27 / 5x max. 60W
IP20
19659, 19660, 19661
chrome/tinted colour/transparent/amber



CASSANDRA

TEXTILE
CABLE



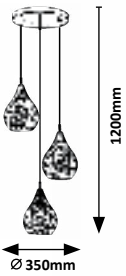

6659



6660





6659  

☒ G9 / 3x max. 40W
IP20 •  19833 (Ø160mm)
chrome/amber



5 358250 366593

6660  

☒ G9 / 5x max. 40W
IP20 •  19834 (Ø195mm)
 19833 (Ø160mm)
chrome/amber



5 358250 366600



SINOPIA

TEXTILE
CABLE

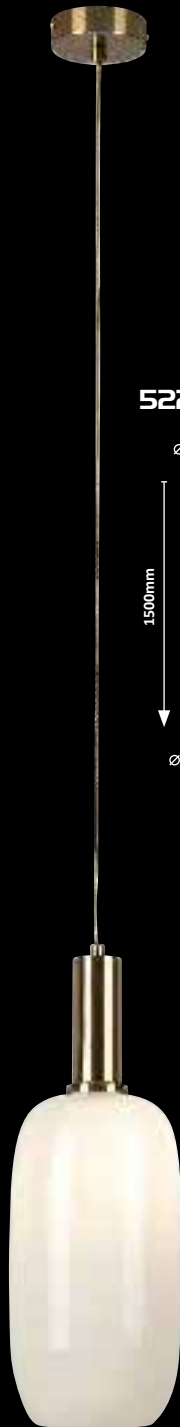

5224



5225

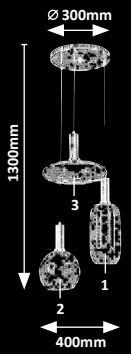

5224 **(M) (G)**

☒ E27 / 1x max. 60W
IP20 • 19928
gold/opal glass

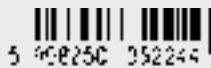

5 408250 052244

5225 **(M) (G)**

☒ E27 / 3x max. 60W
IP20
1: 19928, 2: 19929, 3: 19930
gold/opal glass



5 408250 052251

KASSIA



5394

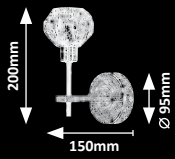

5396

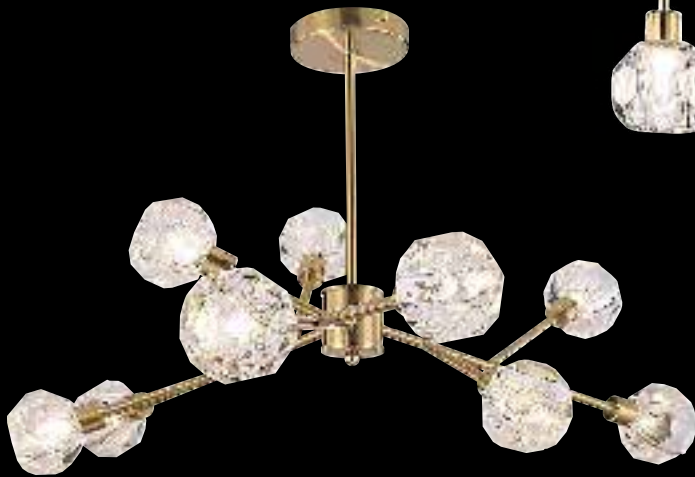

5395

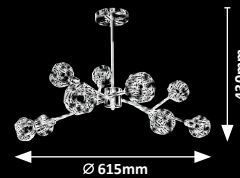

5394 **MG**

☒ G9 / 1x max. 5W
IP20
gold/transparent



5 902250 25394 8

5395 **MG**

☒ G9 / 9x max. 5W
IP20
gold/transparent

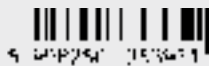

5 902250 25395 8

5396 **MG**

☒ G9 / 5x max. 5W
IP20
gold/transparent

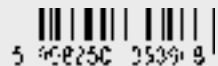

5 902250 25396 8

PHILANA

TEXTILE
CABLE

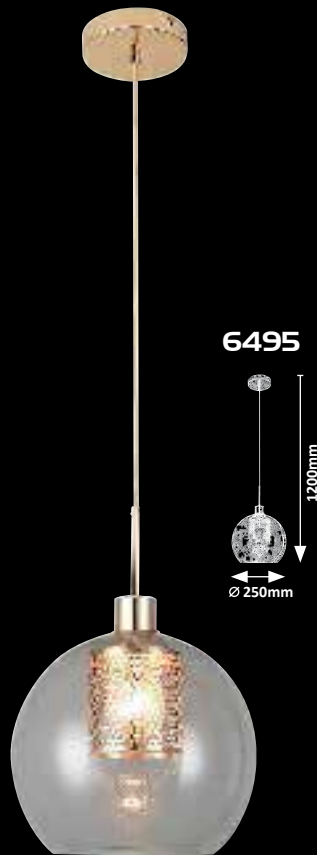

6495 **MG**

☒ E27 / 1x max. 60W
IP20
▣ 19791 (Ø250mm)
gold/transparent



5 362250 064277

6496 **MG**

☒ E27 / 3x max. 60W
IP20 • ▣ 19791 (Ø250mm),
▣ 19792 (Ø200mm)
gold/transparent

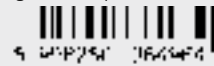

5 362250 064278

DIVINA



5351



5353

TEXTILE
CABLE

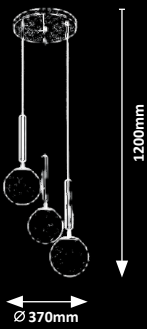

5352

TEXTILE
CABLE



5351 **MG**

☒ E14 / 1x max. 9W
IP20 • 19832
gold/white

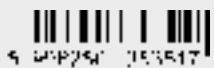

9 509251 103517

5352 **MG**

☒ E14 / 1x max. 9W
IP20 • 19832
gold/white

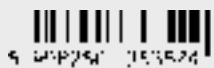

9 509251 103524

5353 **MG**

☒ E14 / 3x max. 9W
IP20 • 19832
gold/white

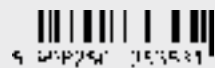

9 509251 103531

PANTHEA

TEXTILE
CABLE



4479



4480



4479 **MG**

☒ E27 / 1x max. 40W
IP20 • 19888
white/gold/transparent



4480 **MG**

☒ E27 / 3x max. 40W
IP20 • 19888
white/gold/transparent

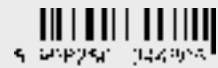

BRIELLA

WARM
White

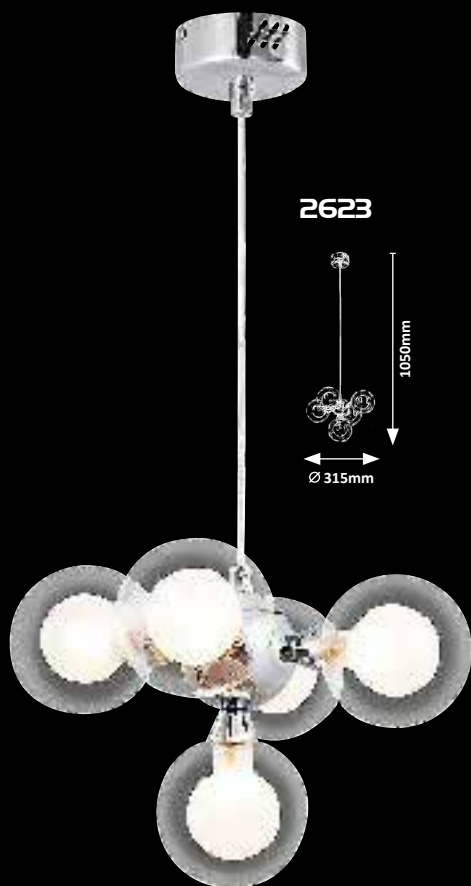

2623

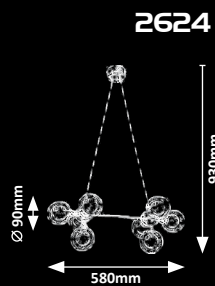
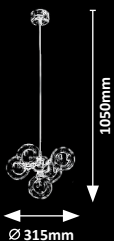

2624

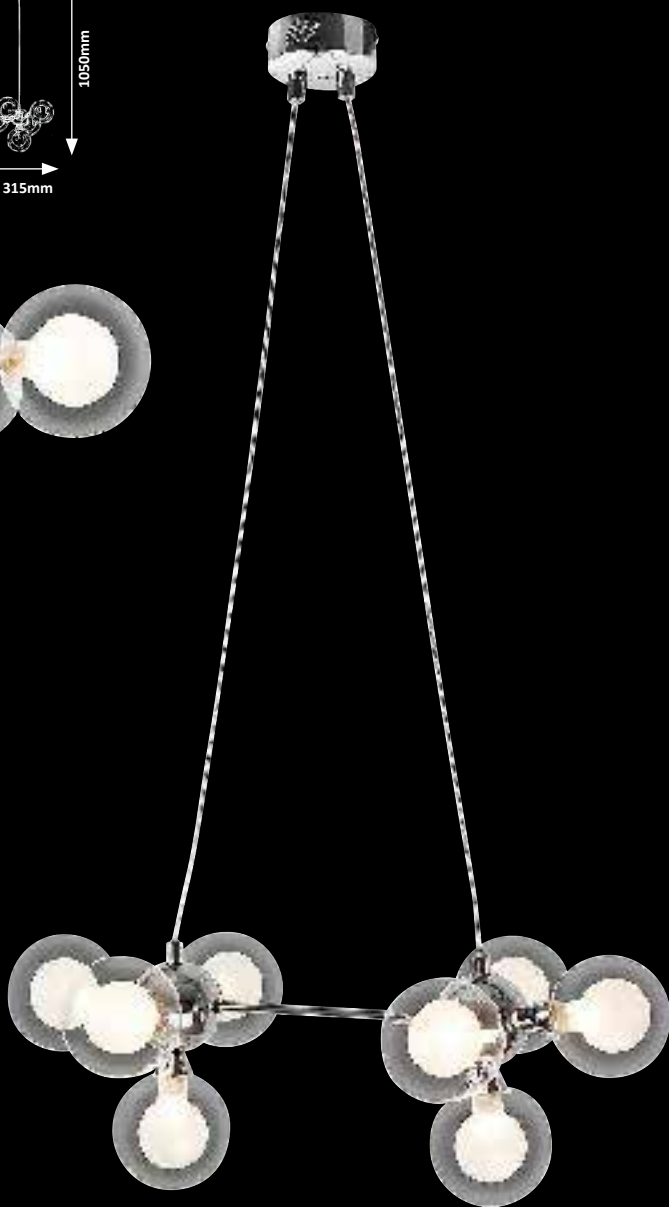

2623 **MG**

☑ 28W (370lm, 2700K) incl.
G9 / 5x max. 28W
IP20 • 19476
chrome/white



S 36225C 22022E

2624 **MG**

☑ 28W (370lm, 2700K) incl.
G9 / 8x max. 28W
IP20 • 19476
chrome/white



S 36225C 22022E



DUCHESS



3113

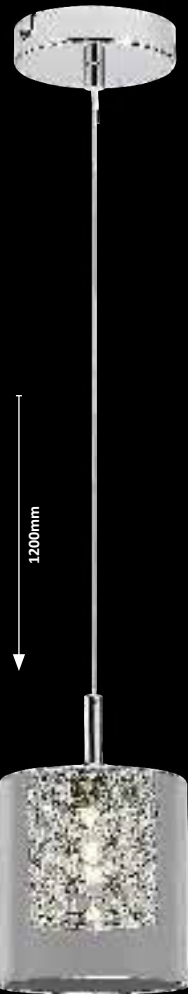
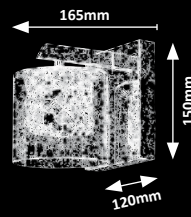

3114

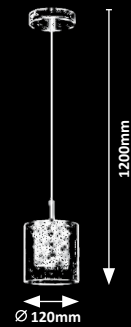

3113 **MG**

☒ G9 / 1x max. 40W
IP20
☒ 19875 • ☒ 19876
chrome/transparent



3114 **MG**

☒ G9 / 1x max. 40W
IP20
☒ 19877 • ☒ 19878
chrome/transparent



DUCHESS

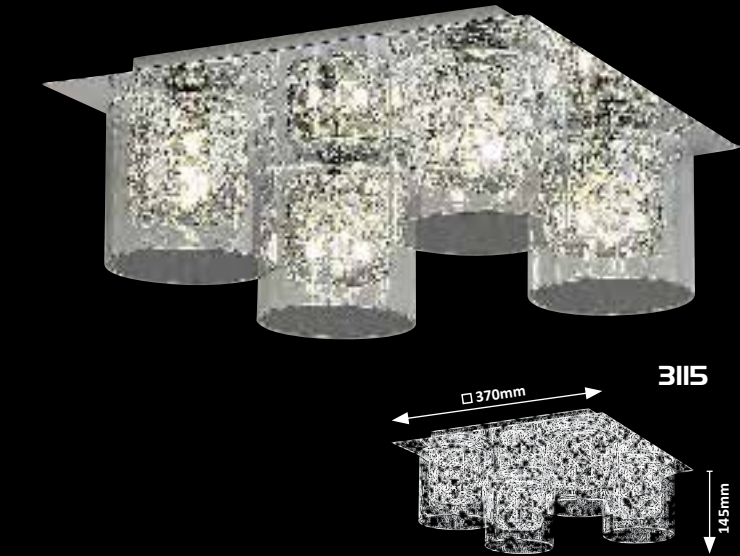

3115 **MG**

☒ G9 / 4x max. 40W
IP20
☒ 19875 • ☒ 19876
chrome/transparent



5 362250 33117

3116 **MG**

☒ G9 / 4x max. 40W
IP20
☒ 19877 • ☒ 19878
chrome/transparent



5 362250 33116

3117 **MG**

☒ G9 / 5x max. 40W
IP20
☒ 19877 • ☒ 19878
chrome/transparent



5 362250 33117

PALLAS

5 YEAR WARRANTY

LED built-in

NATURAL White

SEPARATELY SWITCHABLE

G

A ↑ G



2236

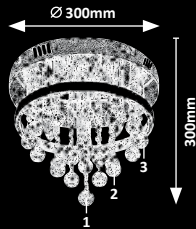

2237

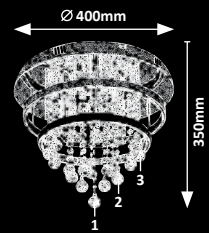

2238

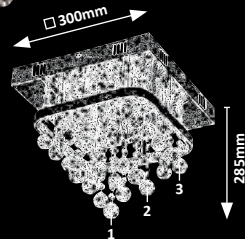

2239

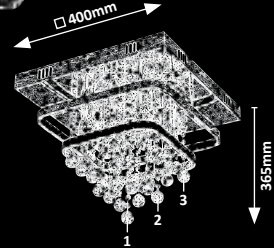

2236 M A GC

LED / 20W (1340lm, 4000K) incl. + E14 / 3x max. 40W • IP20
 1:19962, 2:19963, 3:19964
 chrome/white



5 362250 222306

2237 M A GC

LED / 32W (2030lm, 4000K) incl. + E14 / 3x max. 40W • IP20
 1:19962, 2:19963, 3:19964
 chrome/white



5 362250 222307

2238 M A GC

LED / 23W (1470lm, 4000K) incl. + E14 / 4x max. 40W • IP20
 1:19962, 2:19963, 3:19964
 chrome/white



5 362250 222304

2239 M A GC

LED / 36W (2430lm, 4000K) incl. + E14 / 4x max. 40W • IP20
 1:19962, 2:19963, 3:19964
 chrome/white



5 362250 222301

NINELLE

SEPARATELY SWITCHABLE

2236, 2237, 2238, 2239



3598

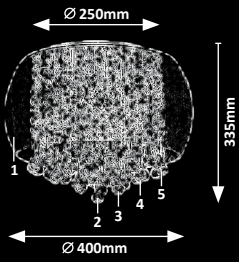

3599

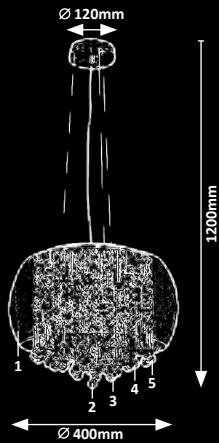

3598 **MG**

☒ G9 / 6x max. 40W
IP20

▣ 1: 19879, 2: 19880, 3: 19881, 4: 19882, 5: 19887
chrome/tinted colour

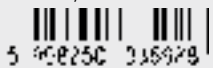

3599 **MG**

☒ G9 / 6x max. 40W
IP20

▣ 1: 19879, 2: 19880, 3: 19881, 4: 19882, 5: 19887
chrome/tinted colour



CORINNA



2615

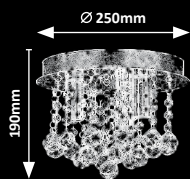

2617

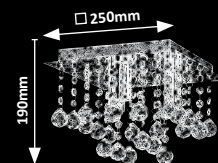

2616

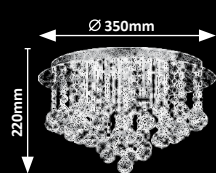

2618

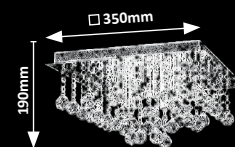

2615 (M) (AC)

☒ E14 / 3x max. 40W
IP20
chrome/transparent



2616 (M) (AC)

☒ E14 / 5x max. 40W
IP20
chrome/transparent



2617 (M) (AC)

☒ E14 / 3x max. 40W
IP20
chrome/transparent



2618 (M) (AC)

☒ E14 / 5x max. 40W
IP20
chrome/transparent



LARISHA



6806

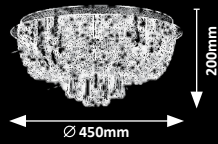

6806 **M G**

☒ G9 / 6x max. 40W
IP20
chrome/transparent

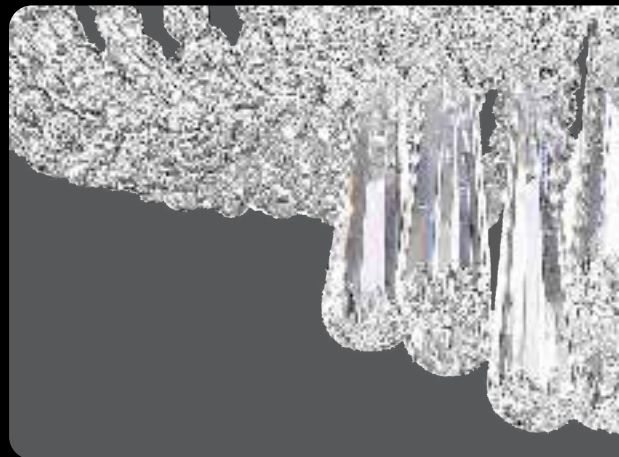

ROSANNA



3569

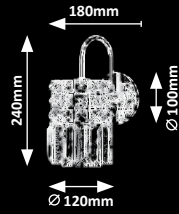

3570

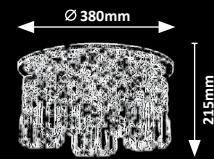

3569 (M) (G)

☒ G9 / 1x max. 40W
IP20 • 19922
chrome/transparent



3570 (M) (G)

☒ G9 / 5x max. 40W
IP20 • 19924
chrome/transparent

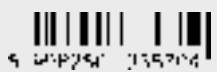

MARCELLA

5
GUARANTEE
YEARS

LED
built-in

NATURAL
White

G A ↑ G



2451

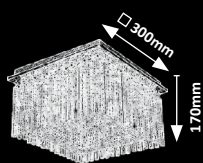

DANIELLE

5
GUARANTEE
YEARS

LED
built-in

NATURAL
White

G A ↑ G



2448

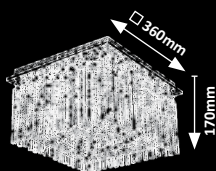

2449

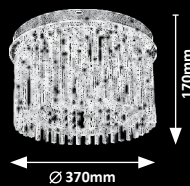

2451 M G

LED / 18W
(1550lm, 4000K) incl.
IP20 • 19511
chrome/crystal



5 362250 3245-7

2448 M A G

LED / 21W
(1750lm, 4000K) incl.
IP20
chrome/crystal



5 362250 3244-8

2449 M A G

LED / 18W
(1500lm, 4000K) incl.
IP20
chrome/crystal



5 362250 3244-9

HESTIA



5299

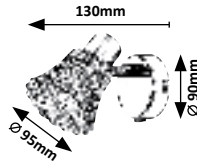

5300

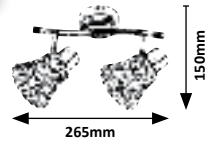

5303

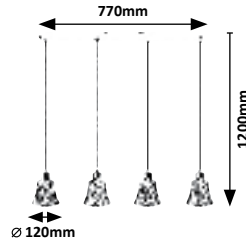

5305

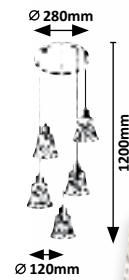

5299 **MG**

☒ E14 / 1x max. 40W
IP20 • 19868
chrome/transparent



5 398296 753292

5300 **MG**

☒ E14 / 2x max. 40W
IP20 • 19868
chrome/transparent



5 398296 753205

5303 **MG**

☒ E14 / 4x max. 40W
IP20 • 19869
chrome/transparent



5 398296 753270

5305 **MG**

☒ E14 / 5x max. 40W
IP20 • 19869
chrome/transparent



5 398296 753270

HESTIA



5301

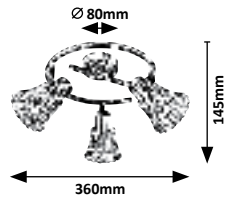

5302

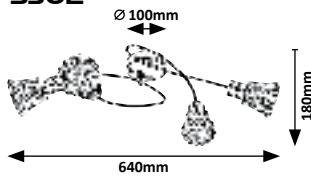

5304

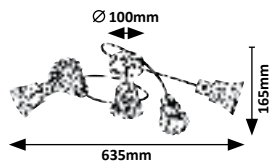

5301 **MG**

☒ E14 / 3x max. 40W
IP20 • 19868
chrome/transparent



5 362250 353212

5302 **MG**

☒ E14 / 4x max. 40W
IP20 • 19868
chrome/transparent



5 362250 353220

5304 **MG**

☒ E14 / 5x max. 40W
IP20 • 19868
chrome/transparent



5 362250 353233

MELISSA



2621

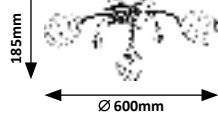

2622

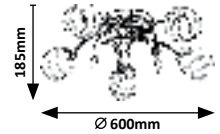

2621 (M) (G)

☒ E14 / 3x max. 60W
IP20 • 19372
chrome/white/crystal



2622 (M) (G)

☒ E14 / 5x max. 60W
IP20 • 19372
chrome/white/crystal



DANILO

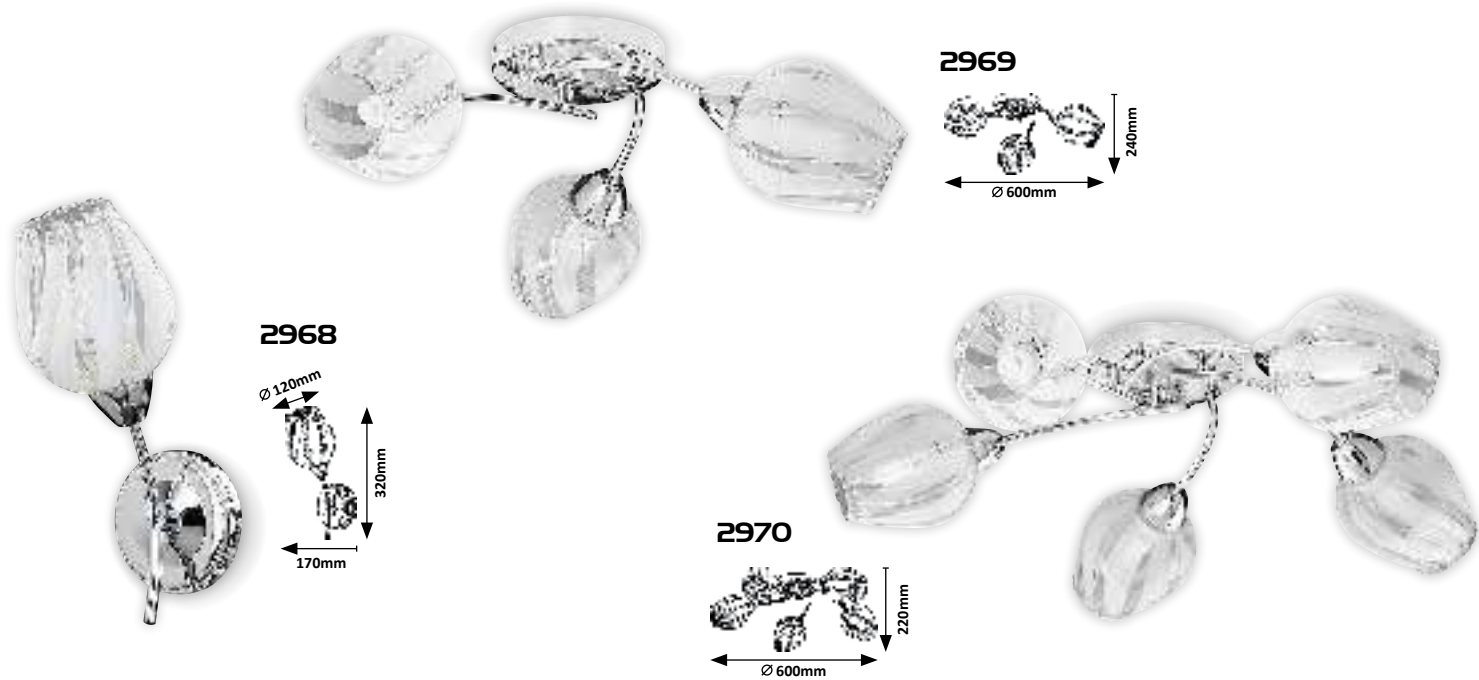

2621

2968 (M) (G)

☒ E27 / 1x max. 60W
IP20 • 19251
chrome/white



5 362250 123620

2969 (M) (G)

☒ E27 / 3x max. 60W
IP20 • 19251
chrome/white



5 362250 123627

2970 (M) (G)

☒ E27 / 5x max. 60W
IP20 • 19251
chrome/white



5 362250 123703



TRISTAN



7201

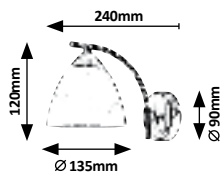

7202

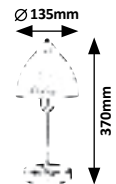

7203

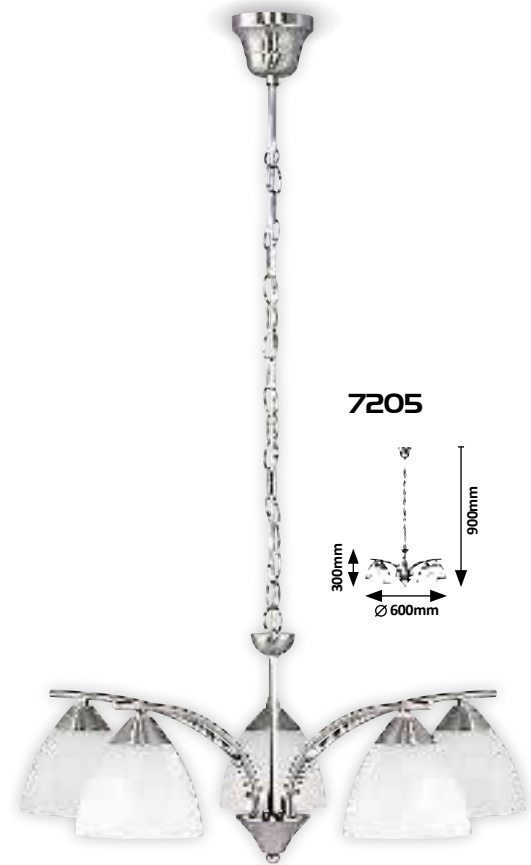
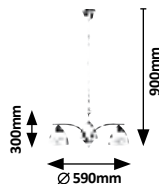

7205

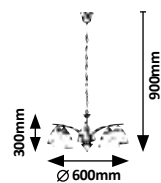

7201 (M) (G)

☒ E14 / 1x max. 40W
IP20 • 9198
satin chrome/white alabaster



5 362260 072013

7202 (M) (G)

☒ E14 / 1x max. 40W
IP20 • 9698
satin chrome/white alabaster



5 362260 072020

7203 (M) (G)

☒ E14 / 3x max. 40W
IP20 • 9198
satin chrome/white alabaster



5 362260 072037

7205 (M) (G)

☒ E14 / 5x max. 40W
IP20 • 9198
satin chrome/white alabaster



5 362260 072051

FRANCESCA

185. | Others / Best match



7361

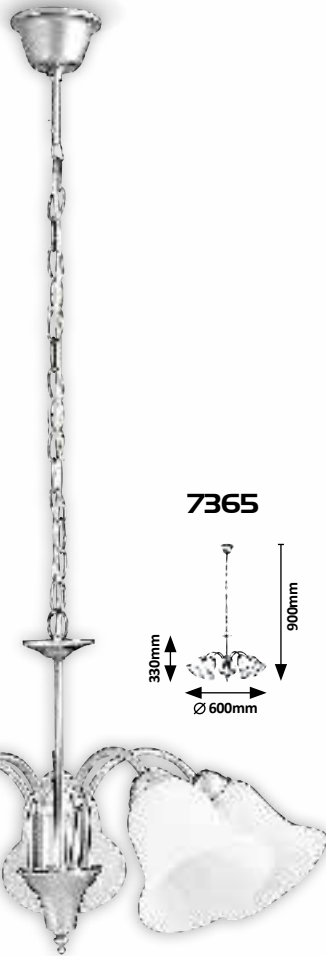
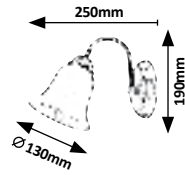

7365

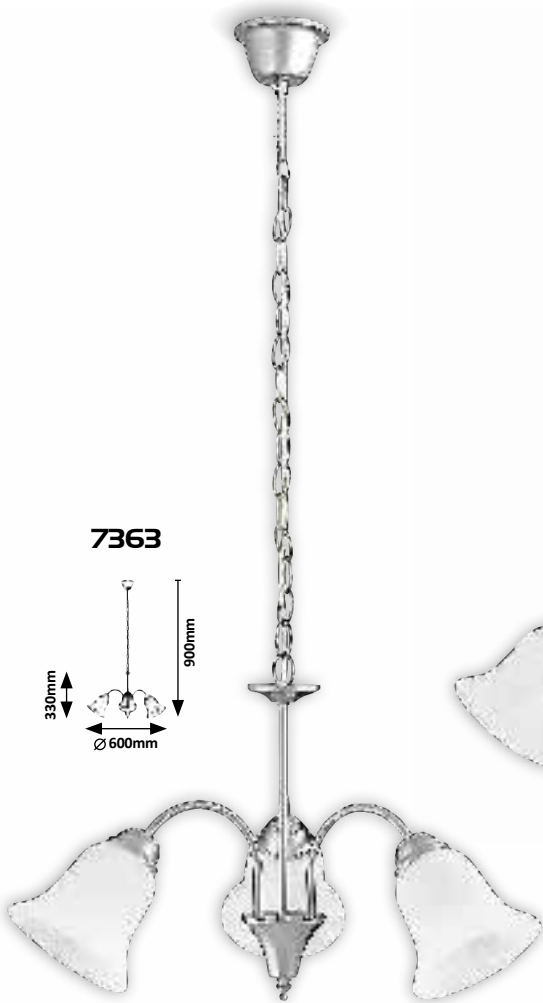
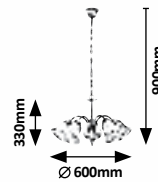

7363

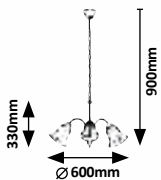

7361 (M) (G)

☒ E14 / 1x max. 40W
IP20 • 9442
satin chrome/white alabaster



5 362250 373614

7363 (M) (G)

☒ E14 / 3x max. 40W
IP20 • 9442
satin chrome/white alabaster



5 362250 373638

7365 (M) (G)

☒ E14 / 5x max. 40W
IP20 • 9442
satin chrome/white alabaster

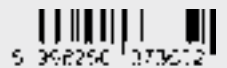

5 362250 373652

RAFAELLA



7231

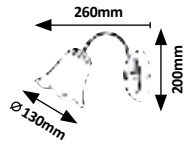

7233

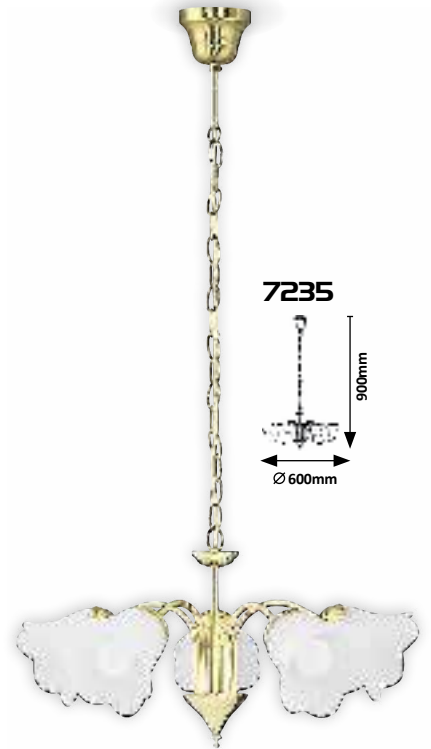
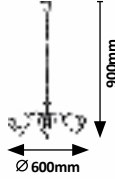

7235

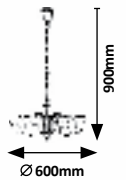

7241

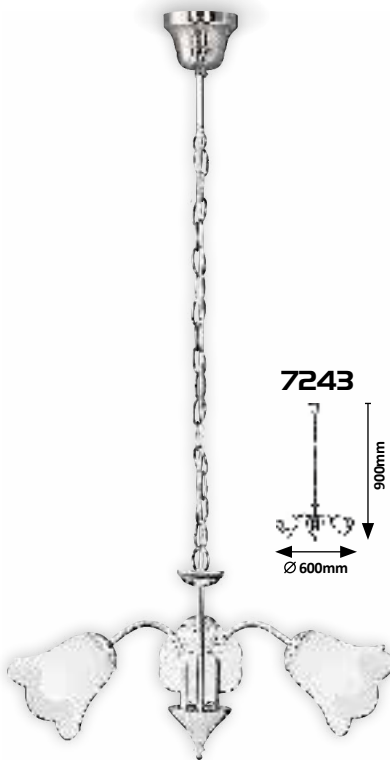
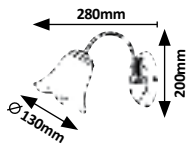

7243

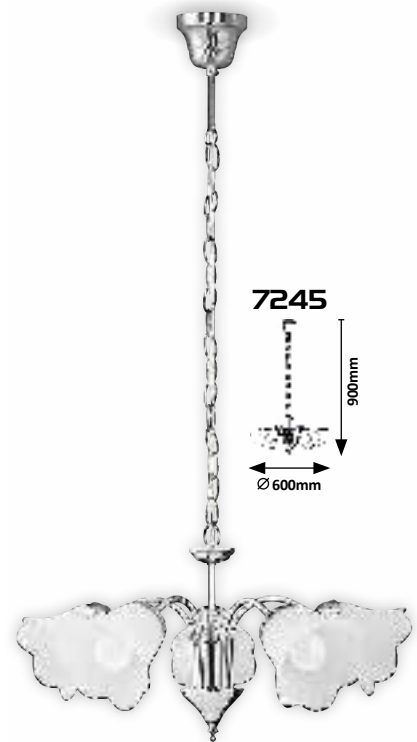
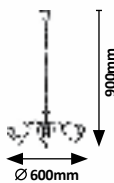

7245

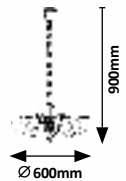

7231 M G

☒ E14 / 1x max. 40W
IP20 • 9443
gold/opal glass

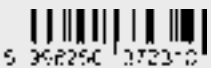

S 362250 372310

7233 M G

☒ E14 / 3x max. 40W
IP20 • 9443
gold/opal glass



S 362250 372330

7235 M G

☒ E14 / 5x max. 40W
IP20 • 9443
gold/opal glass



S 362250 372350

7241 M G

☒ E14 / 1x max. 40W
IP20 • 9443
chrome/opal glass



S 362250 372410

7243 M G

☒ E14 / 3x max. 40W
IP20 • 9443
chrome/opal glass



S 362250 372430

7245 M G

☒ E14 / 5x max. 40W
IP20 • 9443
chrome/opal glass



S 362250 372450

FRANCESCA

183. Others / Best match

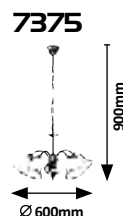
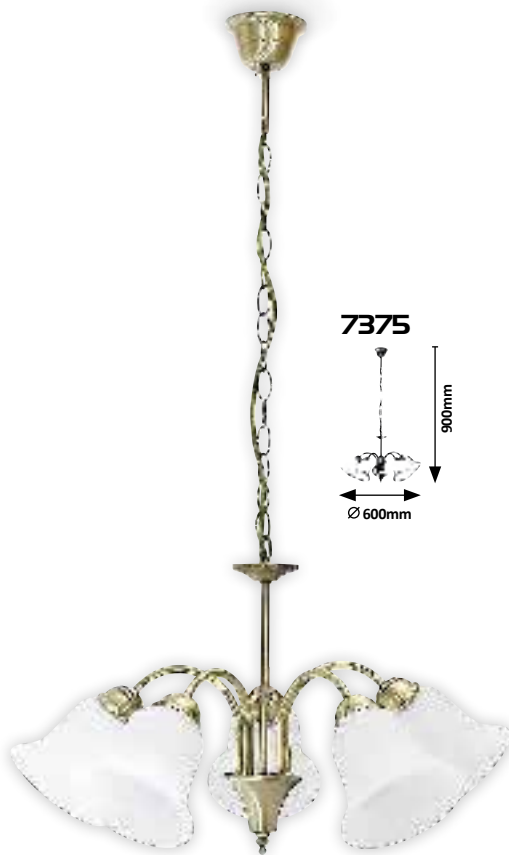
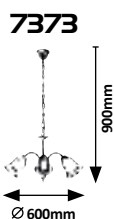
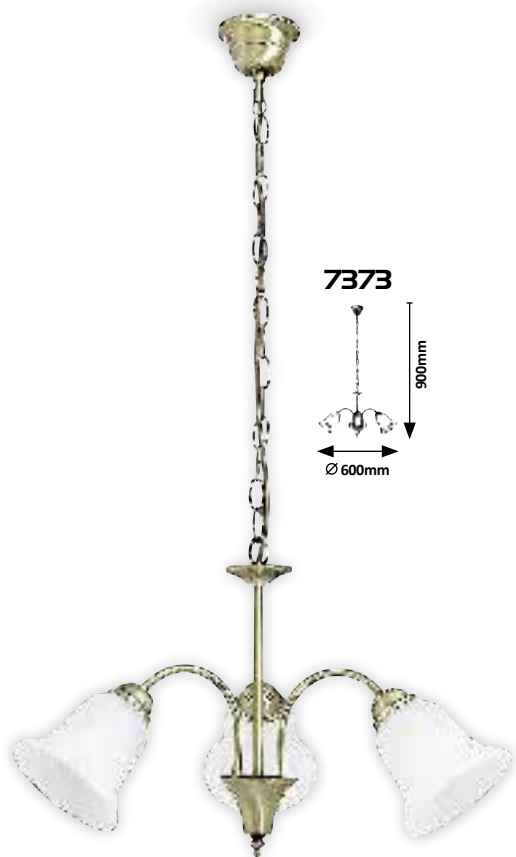
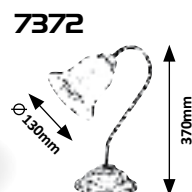
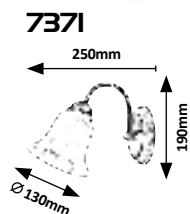

7371 (M) (G)

⊗ E14 / 1x max. 40W
IP20 • 9442
bronze/white alabaster



7372 (M) (G)

⊗ E14 / 1x max. 40W
IP20 • 9442
9442
bronze/white alabaster



7373 (M) (G)

⊗ E14 / 3x max. 40W
IP20 • 9442
bronze/white alabaster



7375 (M) (G)

⊗ E14 / 5x max. 40W
IP20 • 9442
bronze/white alabaster



REGINA



8171

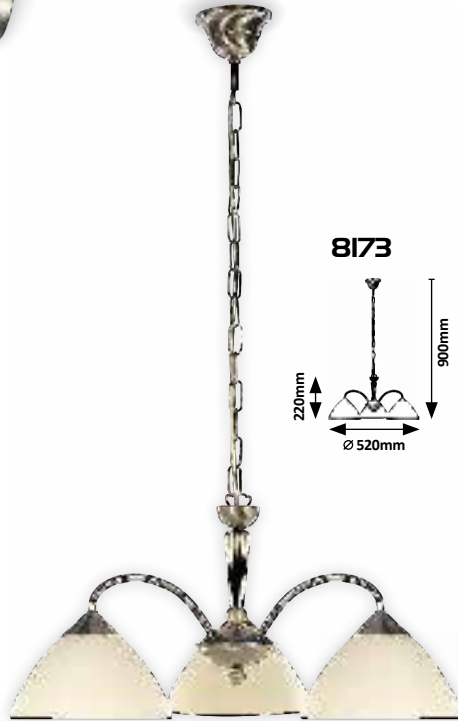
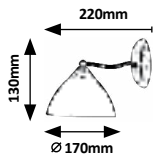

8173

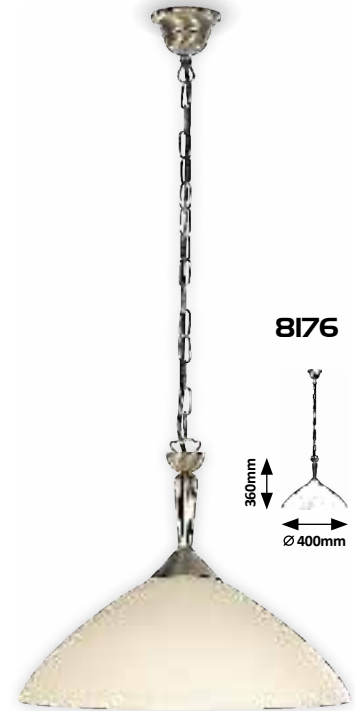
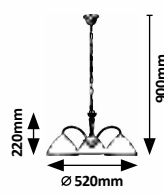

8176

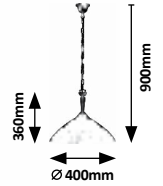

8172

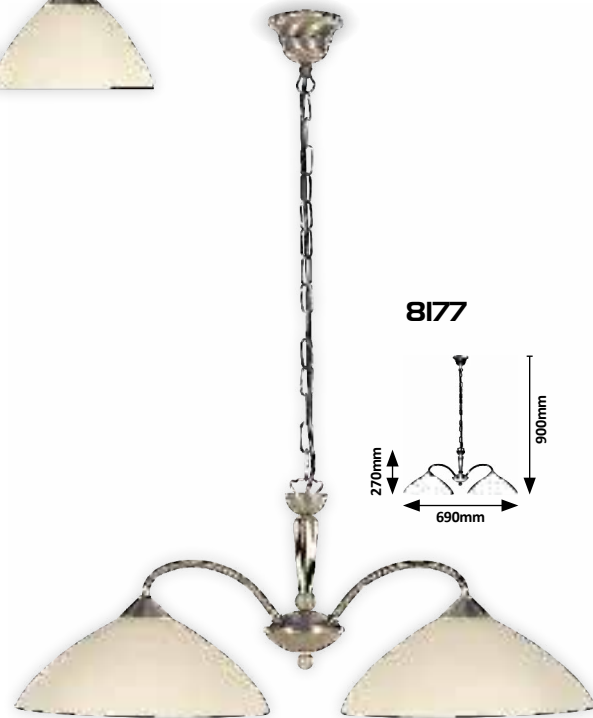
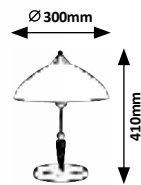

8177

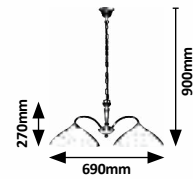

8171 (M) (G)

☒ E14 / 1x max. 40W
IP20 • 9242
bronze/cream



8172 (M) (G)

☒ E14 / 1x max. 40W
IP20 • 9243
9243
bronze/cream



8173 (M) (G)

☒ E14 / 3x max. 40W
IP20 • 9242
bronze/cream



8176 (M) (G)

☒ E27 / 1x max. 60W
IP20 • 9244
bronze/cream



8177 (M) (G)

☒ E27 / 2x max. 60W
IP20 • 9243
bronze/cream



REGINA

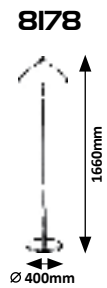
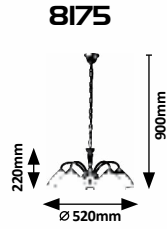
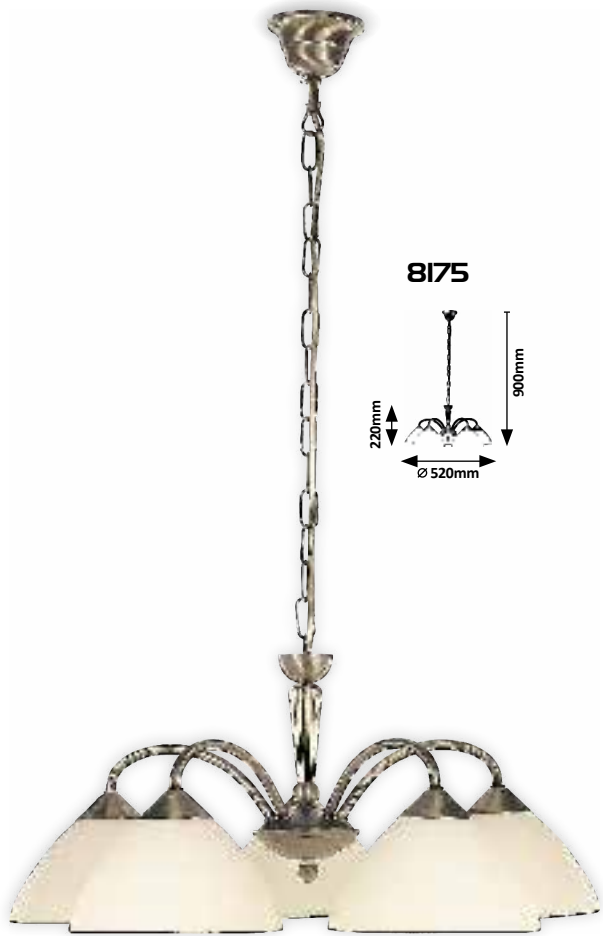

8175 (M) (G)

☒ E14 / 5x max. 40W
IP20 • 9242
bronze/cream



8178 (M) (G)

☒ E27 / 1x max. 60W
IP20 • 9244
bronze/cream



EDITH



7274

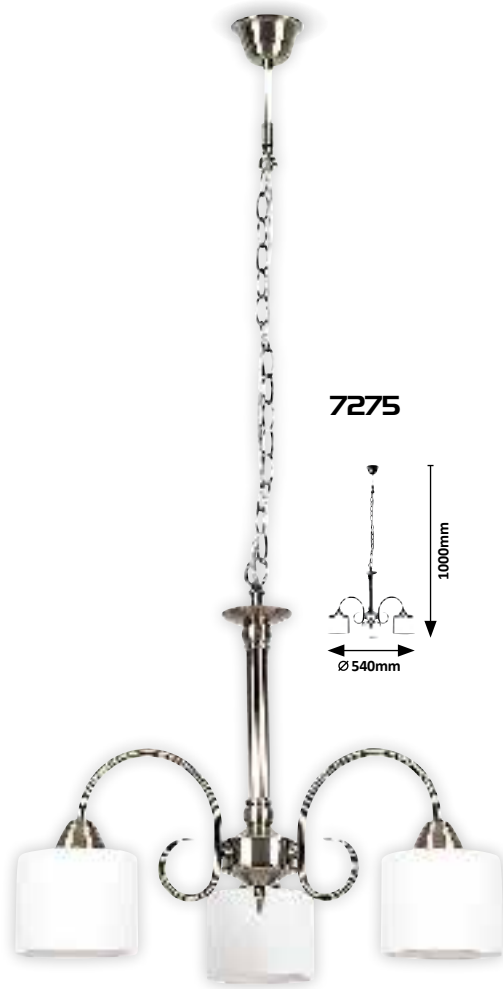
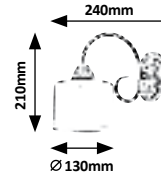

7275

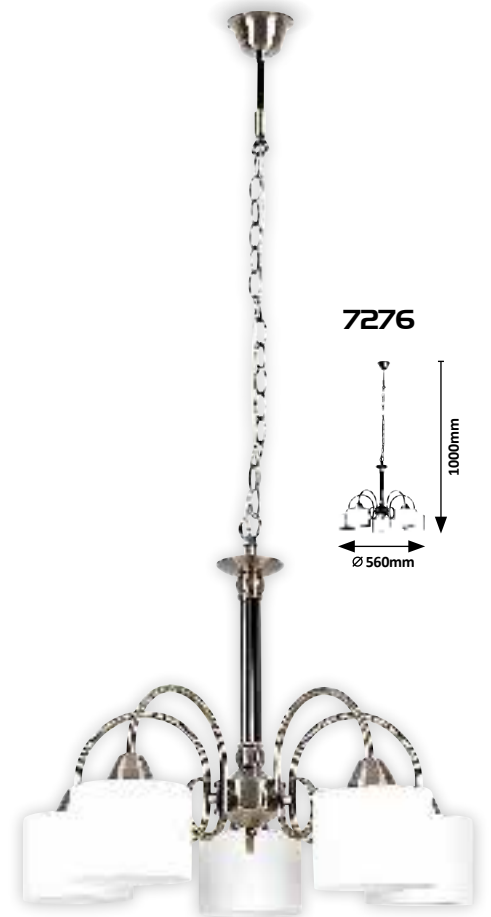
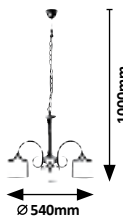

7276

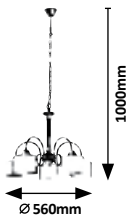

7274 **M G**

☒ E27 / 1x max. 60W
IP20 • 19555
antique bronze/opal glass



7275 **M G**

☒ E27 / 3x max. 60W
IP20 • 19555
antique bronze/opal glass



7276 **M G**

☒ E27 / 5x max. 60W
IP20 • 19555
antique bronze/opal glass



ALETTA



2778

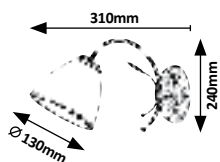

2780

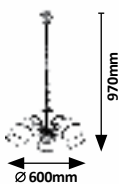

2779

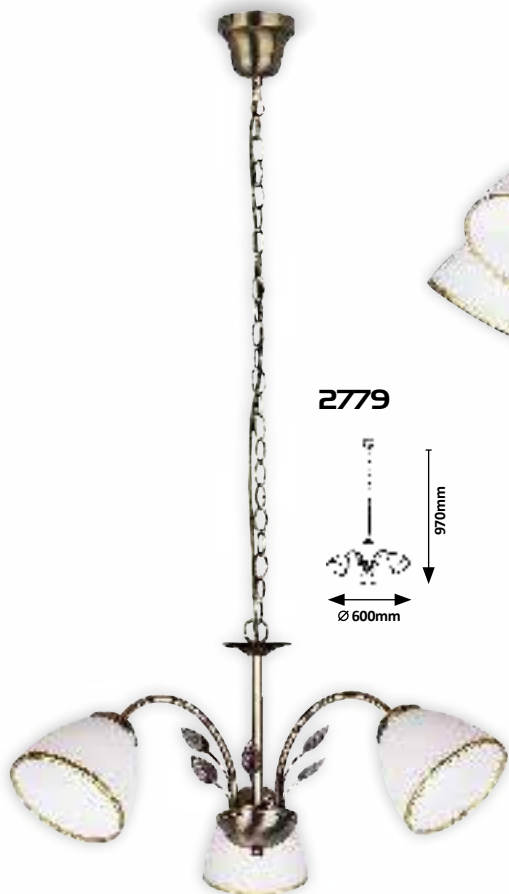
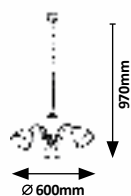

2778 (M) (G)

☒ E14 / 1x max. 40W
IP20 • 19192
bronze/white



2779 (M) (G)

☒ E14 / 3x max. 40W
IP20 • 19192
bronze/white



2780 (M) (G)

☒ E14 / 5x max. 40W
IP20 • 19192
bronze/white



MARIAN

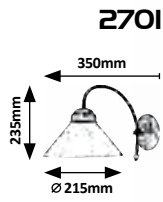

2701

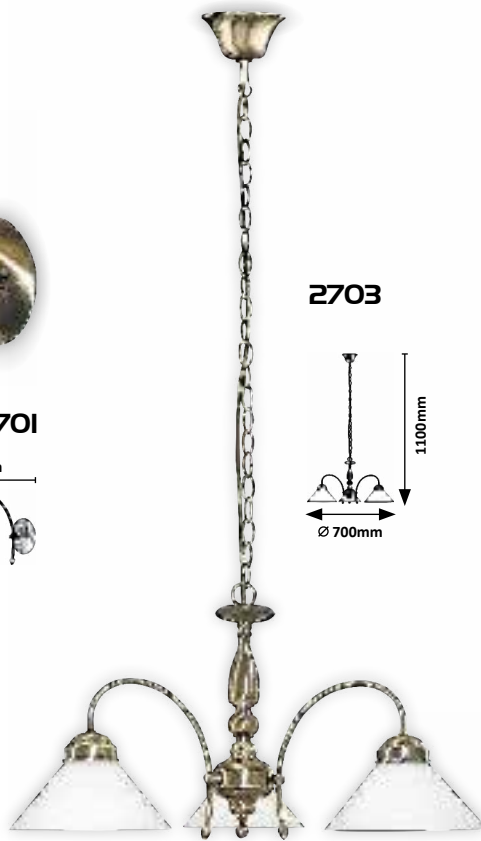

2703

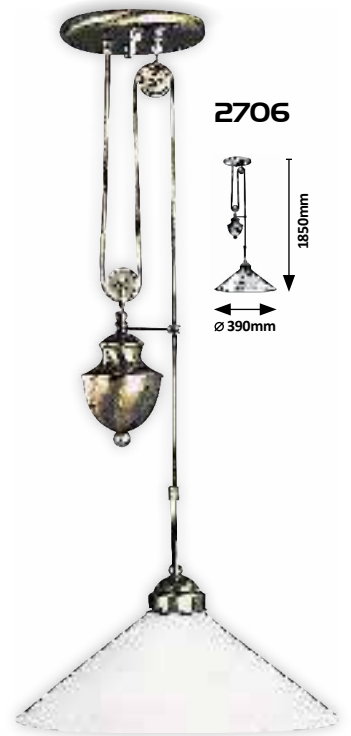
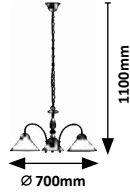

2706

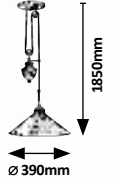

2702

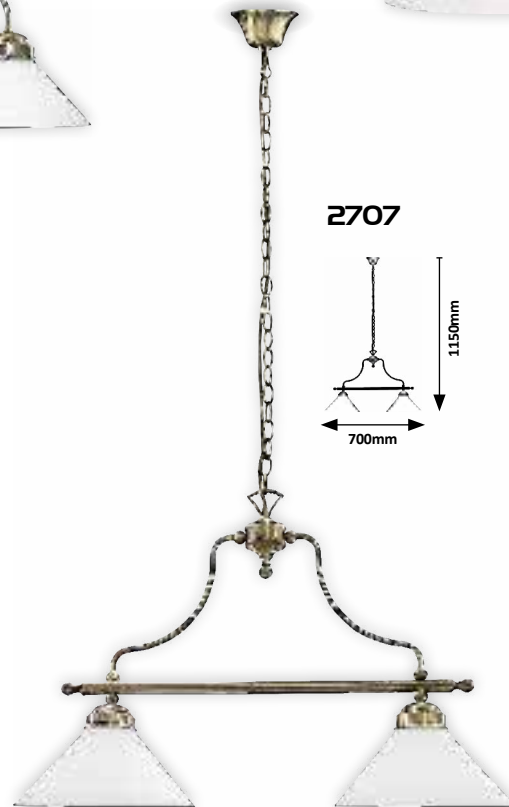
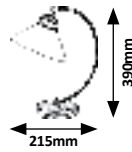

2707

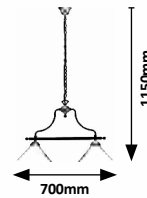

2701 (M G)

☒ E27 / 1x max. 60W
IP20 • 9933
bronze/white



2702 (M G)

☒ E27 / 1x max. 60W
IP20 • 9933
bronze/white



2703 (M G)

☒ E27 / 3x max. 60W
IP20 • 9933
bronze/white



2706 (M G)

☒ E27 / 1x max. 100W
IP20 • 9936
bronze/white



2707 (M G)

☒ E27 / 2x max. 60W
IP20 • 9935
bronze/white



MARIAN

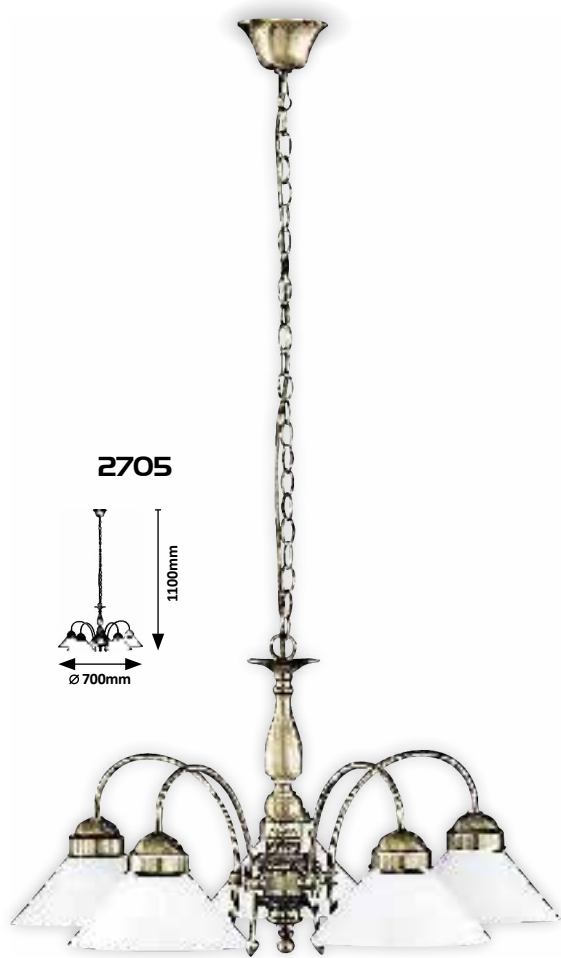

2705

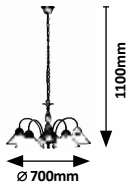

2708

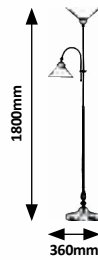

2705 **M G**

☒ E27 / 5x max. 60W
IP20 • 9933
bronze/white



S 362250 327011

2708 **M G**

☒ E27 / 2x max. 60W
IP20 • 9934 • 9933
bronze/white



S 362250 327022

MARLENE

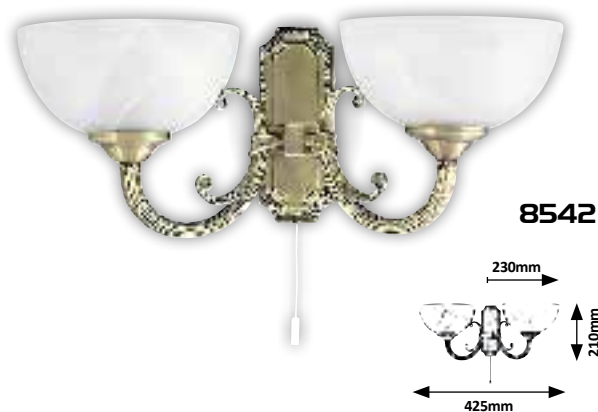
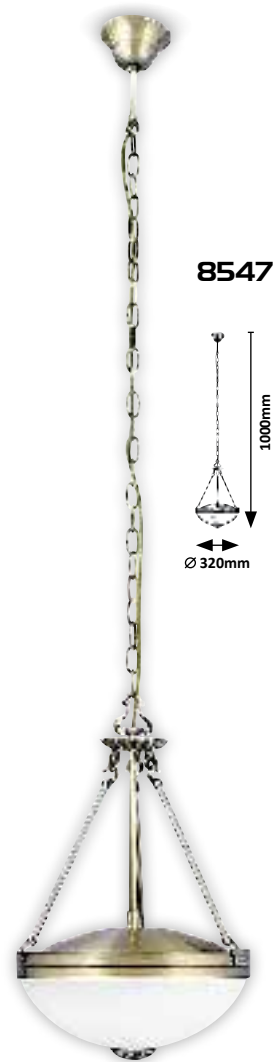
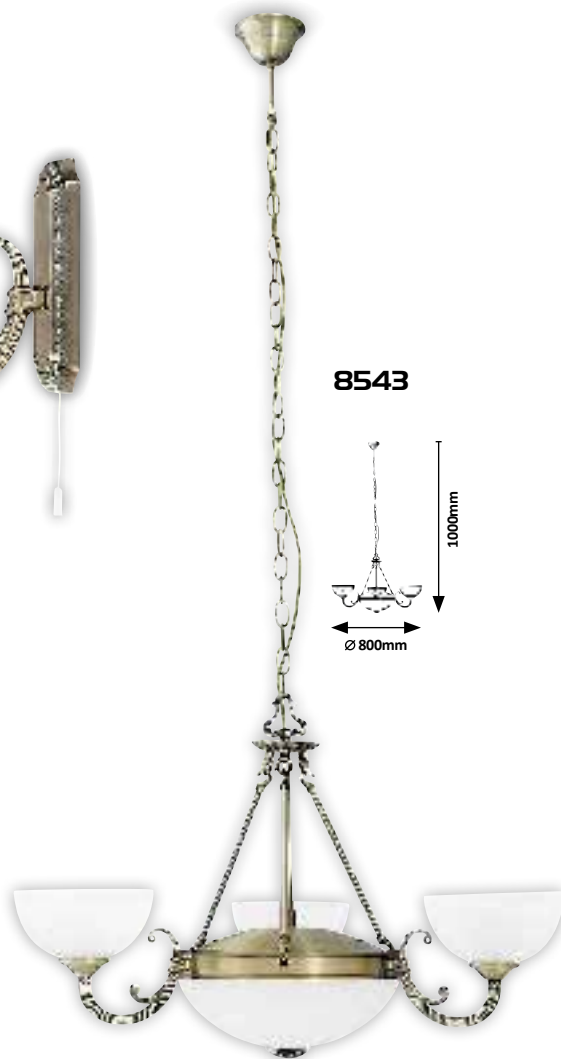

8541 (M) (G)

☒ E14 / 1x max. 40W
IP20 • □
▣ 9523
bronze/white alabaster



8542 (M) (G)

☒ E14 / 2x max. 40W
IP20 • □
▣ 9523
bronze/white alabaster



8543 (M) (G)

☒ E27 / 2x max. 60W +
E14 / 3x max. 40W
IP20 • ▣ 9527 • ▣ 9523
bronze/white alabaster



8546 (M) (G)

☒ E27 / 2x max. 60W +
E14 / 6x max. 40W
IP20 • ▣ 9527 • ▣ 9523
bronze/white alabaster



8547 (M) (G)

☒ E27 / 2x max. 60W
IP20 • ▣ 9527
bronze/white alabaster



FLOSSI



8811

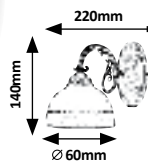

8812

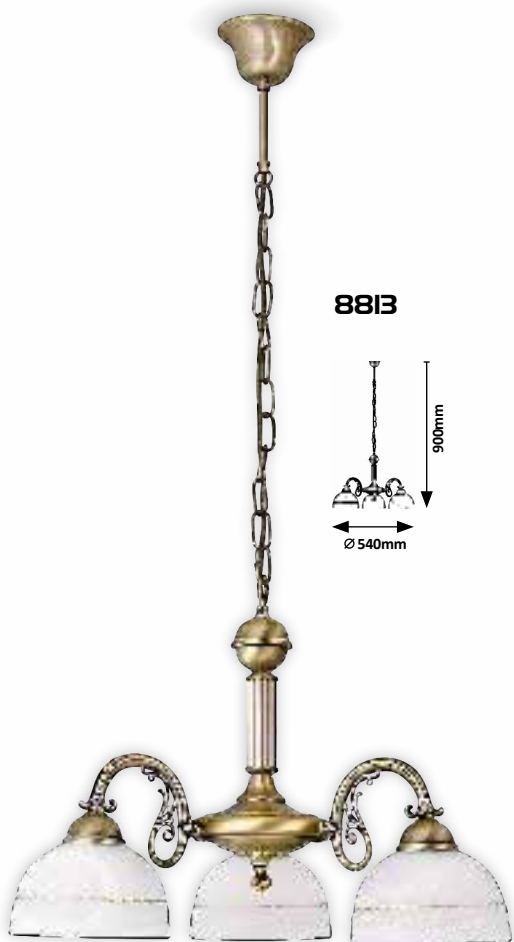
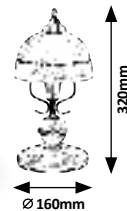

8813

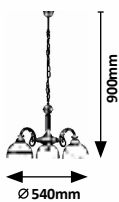

8815

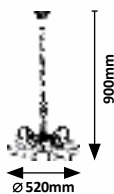

8811 (M) (G)

☒ E27 / 1x max. 40W
IP20 • 9287
bronze/white



S 392250 325 13

8812 (M) (G)

☒ E14 / 1x max. 40W
IP20 • 9896
bronze/white



S 392250 325 20

8813 (M) (G)

☒ E27 / 3x max. 40W
IP20 • 9287
bronze/white



S 392250 325 37

8815 (M) (G)

☒ E27 / 5x max. 40W
IP20 • 9287
bronze/white



S 392250 325 11

ELISETT

2755

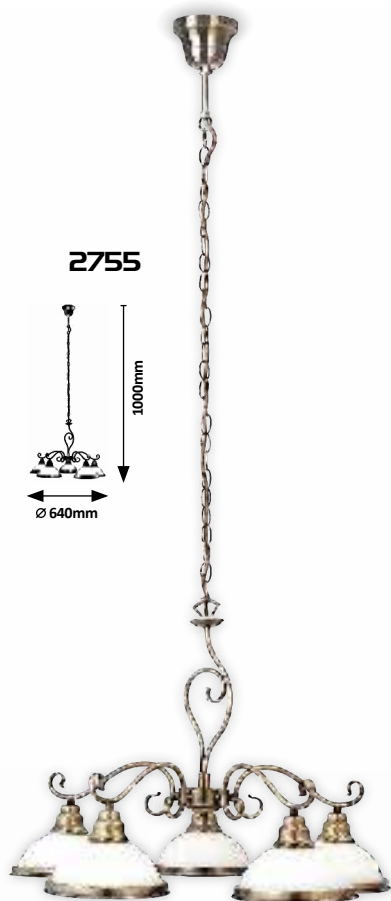
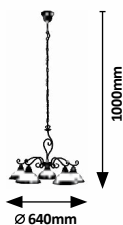

2756

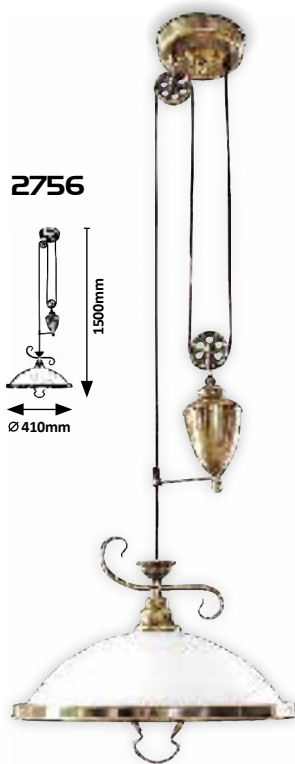

2753

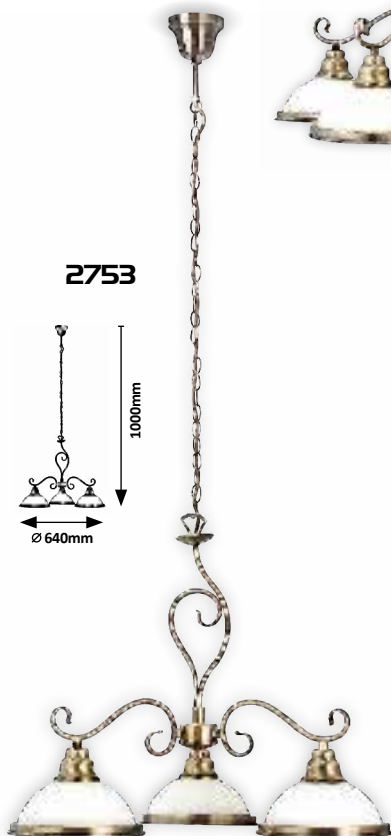
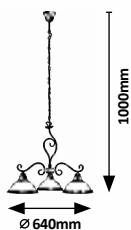

2757

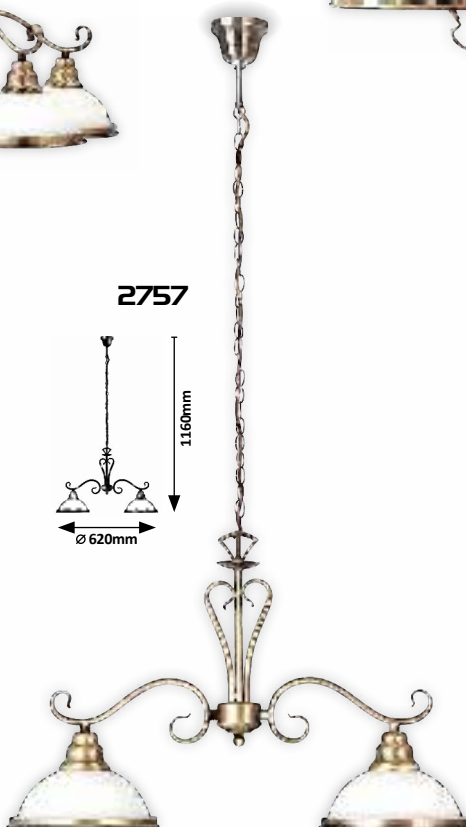
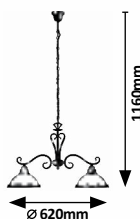

2758

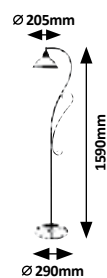

2753 (M G)

☒ E27 / 3x max. 60W
IP20 • 9953
bronze/white



2755 (M G)

☒ E27 / 5x max. 60W
IP20 • 9953
bronze/white



2756 (M G)

☒ E27 / 1x max. 60W
IP20 • 9046
bronze/white



2757 (M G)

☒ E27 / 2x max. 60W
IP20 • 9953
bronze/white



2758 (M G)

☒ E27 / 1x max. 60W
IP20 • 9953
bronze/white



ELISETT

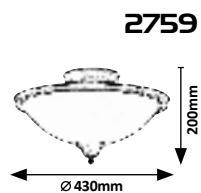
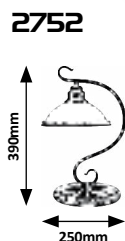
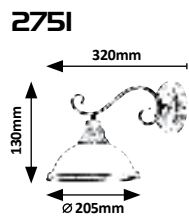

2751 (M) (G)

☒ E27 / 1x max. 60W
IP20 • 9953
bronze/white



S 36R25C 1275-E

2752 (M) (G)

☒ E27 / 1x max. 60W
IP20 • 9953
bronze/white



S 36R25C 12752-E

2759 (M) (G)

☒ E14 / 2x max. 40W
IP20 • 9954
bronze/white



S 36R25C 12759-E

ANNABELLA

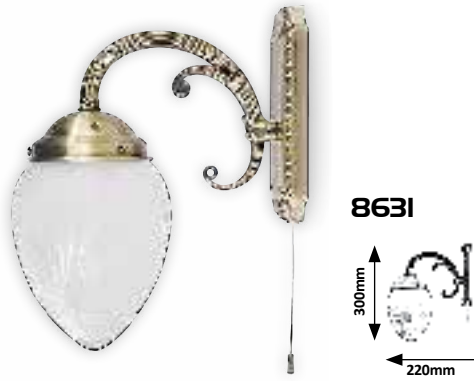

8631

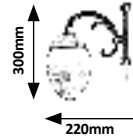

8638

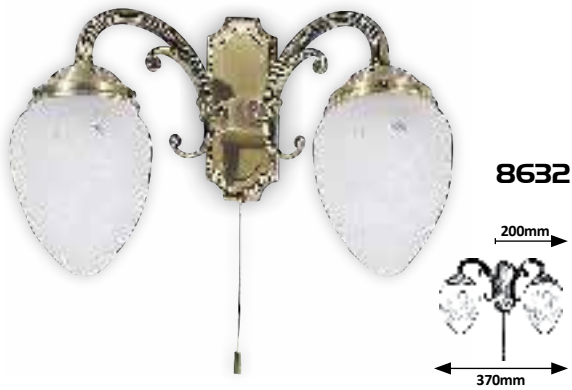
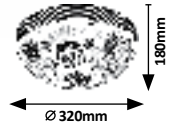

8632

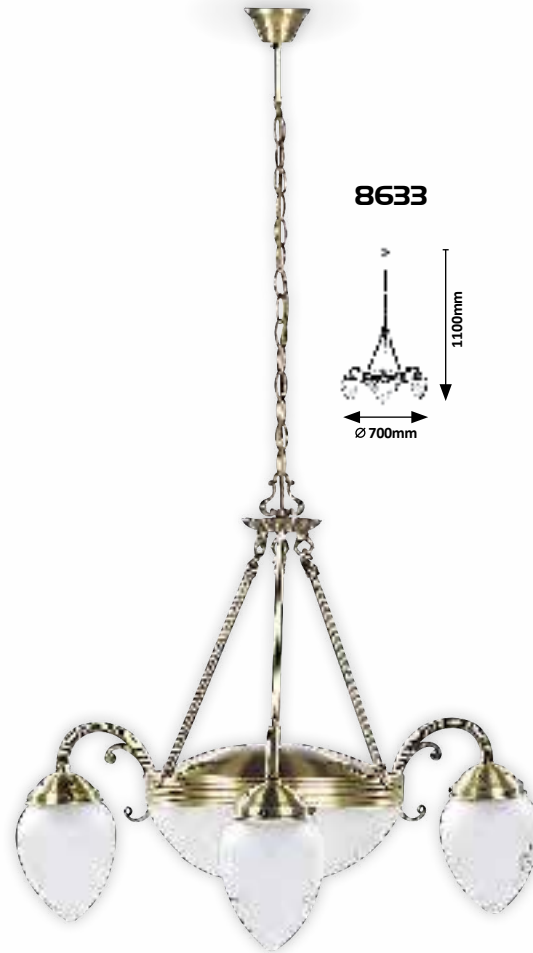
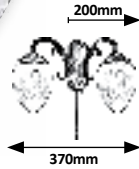

8633

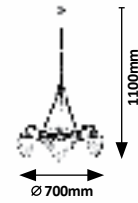

8634

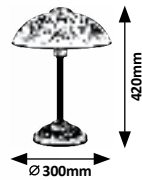

8631 **M G**

☒ E14 / 1x max. 40W
IP20 • □
▣ 9904
bronze/white



8632 **M G**

☒ E14 / 2x max. 40W
IP20 • □
▣ 9904
bronze/white



8633 **M G**

☒ E27 / 2x max. 60W
+ E14 / 3x max. 40W
IP20 • ▣ 9905 • ▣ 9904
bronze/white



8634 **M G**

☒ E14 / 1x max. 40W
IP20 • □
▣ 9905
bronze/white



8638 **M G**

☒ E27 / 2x max. 60W
IP20 • ▣ 9905
bronze/white



ANNABELLA

8637

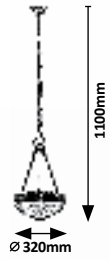

8636

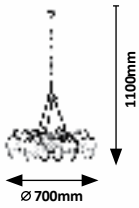

8634



8636 (M) (G)

☒ E27 / 2x max. 60W
+ E14 / 6x max. 40W
IP20 • 9905 • 9904
bronze/white



5 362250 320302

8637 (M) (G)

☒ E27 / 2x max. 60W
IP20 • 9905
bronze/white



5 362250 320300

ORCHIDEA



8558

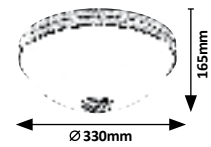

JOEL



2269

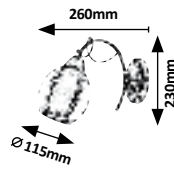

2270

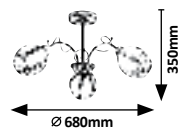

2271

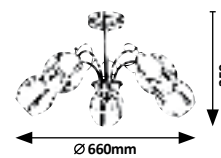

8558 **M G**

☒ E27 / 2x max. 60W
IP20 • 9528
bronze/white alabaster



2269 **M G**

☒ E27 / 1x max. 60W
IP20 • 19259
bronze/white



2270 **M G**

☒ E27 / 3x max. 60W
IP20 • 19259
bronze/white



2271 **M G**

☒ E27 / 5x max. 60W
IP20 • 19259
bronze/white



BECKWORTH

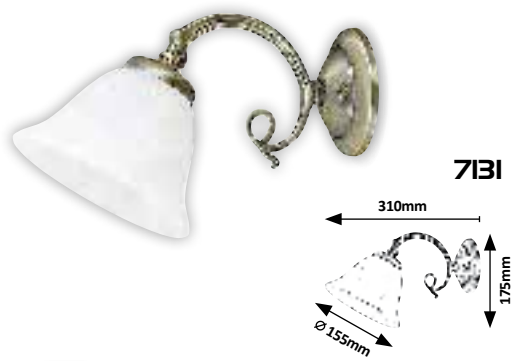

7131

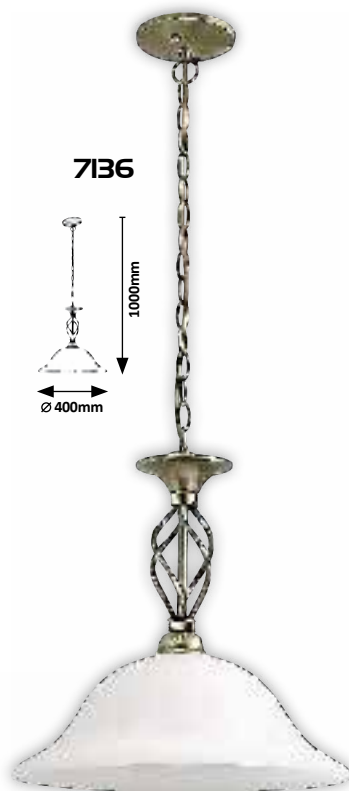

7136

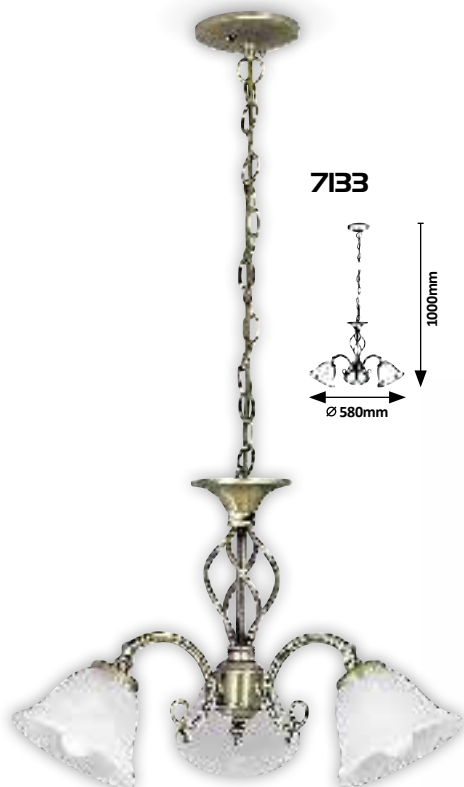

7133

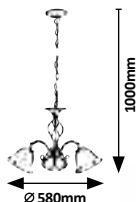

7135

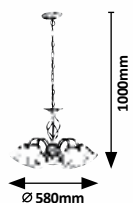

7131 (M G)

☒ E14 / 1x max. 40W
IP20 • 9493
bronze/white alabaster



S 36R25C 37'373

7133 (M G)

☒ E14 / 3x max. 40W
IP20 • 9493
bronze/white alabaster



S 36R25C 37'377

7135 (M G)

☒ E14 / 5x max. 40W
IP20 • 9493
bronze/white alabaster



S 36R25C 37'371

7136 (M G)

☒ E27 / 1x max. 60W
IP20 • 9515
bronze/white alabaster



S 36R25C 37'366

SORAYA



3966



3967



3968

3966 **M G**

☒ E14 / 1x max. 40W
IP20 • 19873
green/white



3967 **M G**

☒ E14 / 2x max. 40W
IP20 • 19873
green/white



3968 **M G**

☒ E14 / 3x max. 40W
IP20 • 19873
green/white



SORAYA

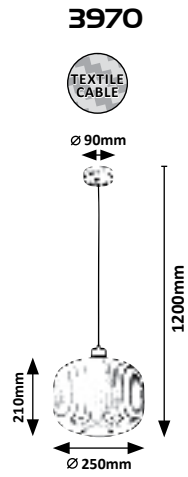
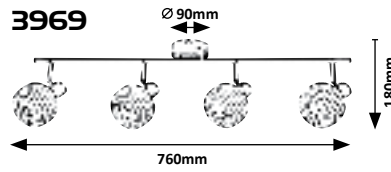

3969 **M G**

☒ E14 / 4x max. 40W
IP20 • 19873
green/white



3970 **M G**

☒ E27 / 1x max. 60W
IP20 • 19874
green/white



SORINA



3918

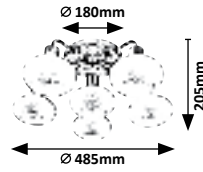

3916

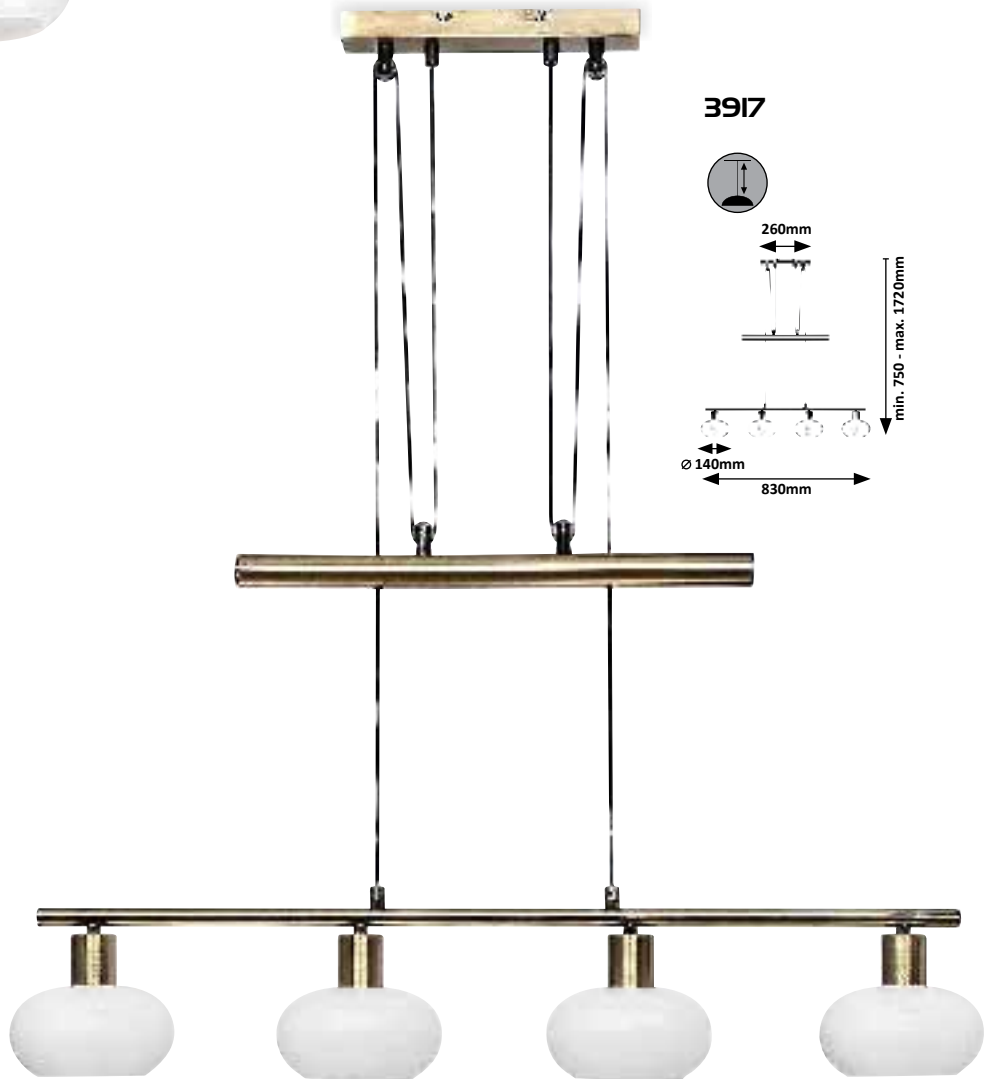
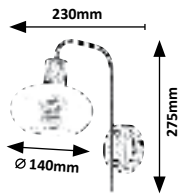

3917

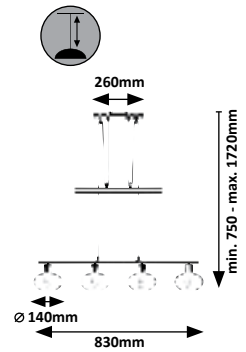

3916

MG

☒ E14 / 1x max. 40W
IP20 • 19864
antique bronze/white



3917

MG

☒ E14 / 4x max. 40W
IP20 • 19864
antique bronze/white

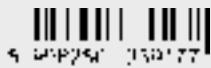

3918

MG

☒ E14 / 6x max. 40W
IP20 • 19864
antique bronze/white

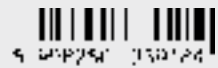

EVANGELINE

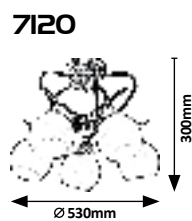
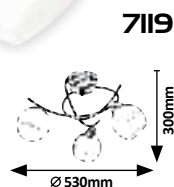
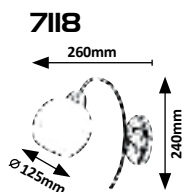

7118 **MG**

☒ E14 / 1x max. 40W
IP20 • 19480
antique bronze/white



7119 **MG**

☒ E14 / 3x max. 40W
IP20 • 19480
antique bronze/white



7120 **MG**

☒ E14 / 5x max. 40W
IP20 • 19480
antique bronze/white



EMILY



2619

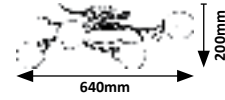

2620



2619



☒ E14 / 4x max. 40W
IP20 • 19376
bronze/white



5 362250 225191

2620



☒ E14 / 4x max. 40W
IP20 • 19376
satin chrome/white



5 362250 225207



FAUNA



5098

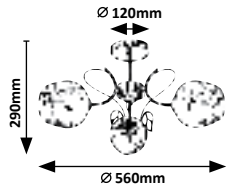

5099

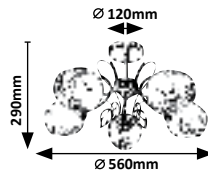

LILIAN

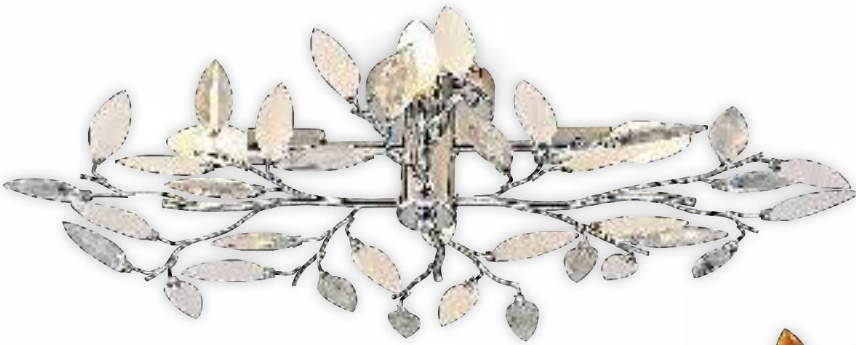

2839

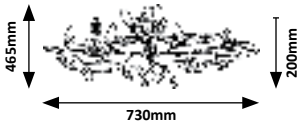

2849

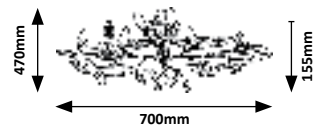

5098 (M G)

☒ E27 / G45 / 3x max. 40W
IP20 • 19860
gold/white



5 392250 250381

5099 (M G)

☒ E27 / G45 / 5x max. 40W
IP20 • 19860
gold/white

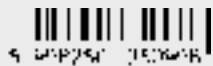

5 392250 250398

2839 (M A)

☒ E14 / 4x max. 40W
IP20 • 19119
chrome/opal glass



5 392250 225393

2849 (M A)

☒ E14 / 4x max. 40W
IP20
antique brown/opal glass/
amber



5 392250 225492

RUSTIC 3

WOOD



7091

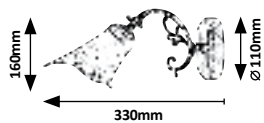

7092

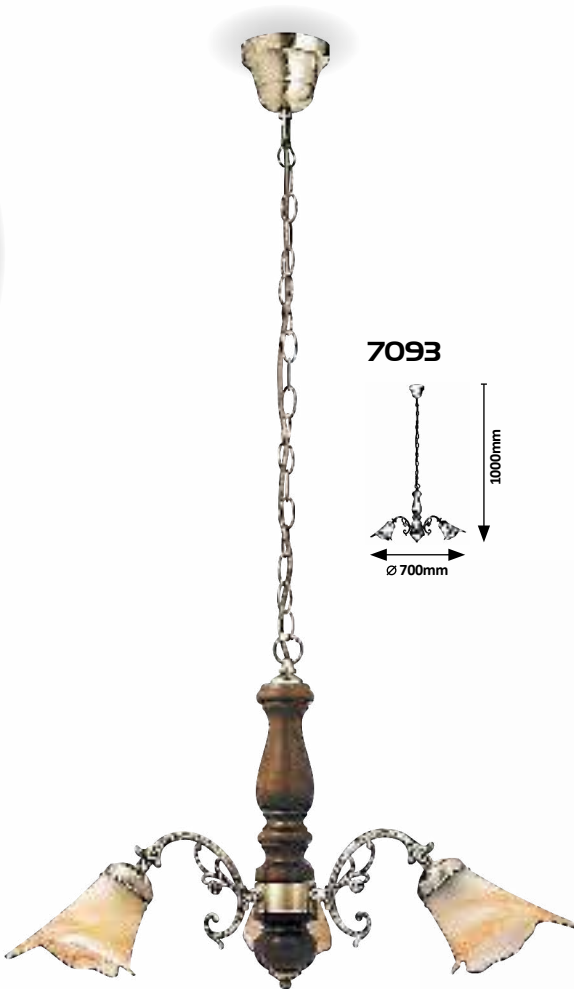
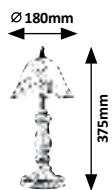

7093

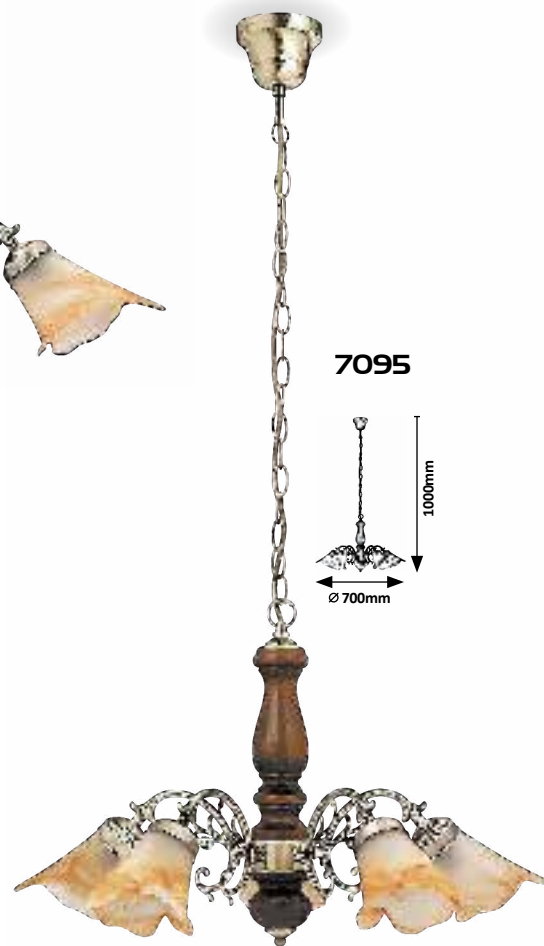
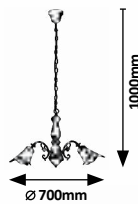

7095

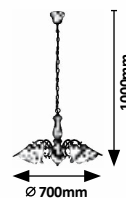

7091 MWG

☒ E14 / 1x max. 40W
IP20 • 9615
black/brown alabaster



S 36R25C 070010

7092 MWG

☒ E14 / 1x max. 40W
IP20 • 9617
black/brown alabaster



S 36R25C 070027

7093 MWG

☒ E14 / 3x max. 40W
IP20 • 9615
black/brown alabaster



S 36R25C 070034

7095 MWG

☒ E14 / 5x max. 40W
IP20 • 9615
black/brown alabaster



S 36R25C 070018

COLETTE

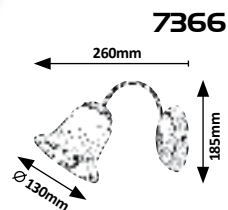

7366

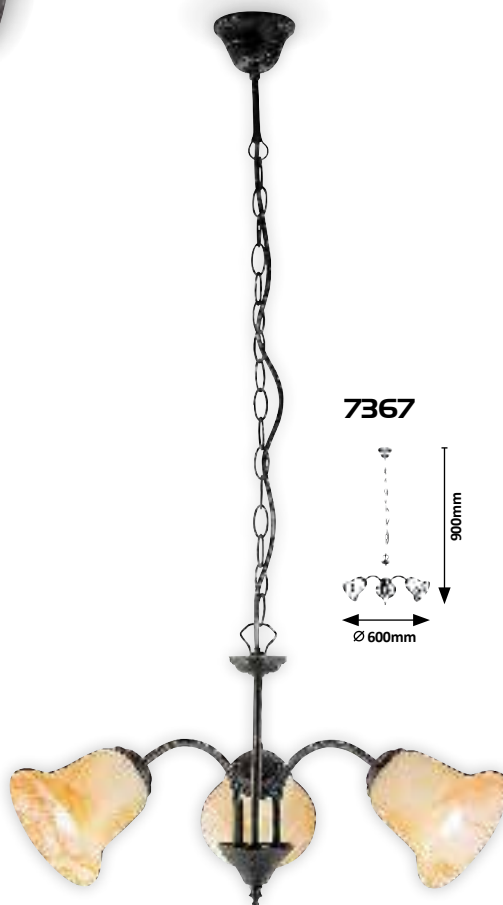

7367

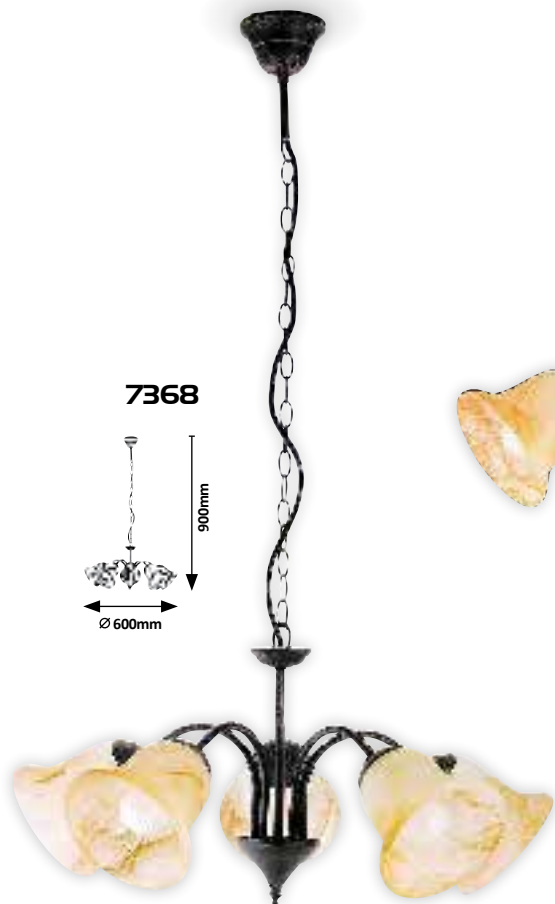
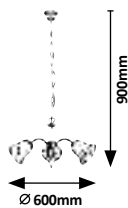

7368

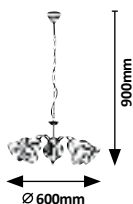

7366 (M) (G)

☒ E14 / 1x max. 40W
IP20 • 9734
black/brown alabaster



7367 (M) (G)

☒ E14 / 3x max. 40W
IP20 • 9734
black/brown alabaster



7368 (M) (G)

☒ E14 / 5x max. 40W
IP20 • 9734
black/brown alabaster



SUDAN



7991 (M) (G)

☒ E27 / 1x max. 60W
IP20 • 9082
bronze/white



7992 (M) (G)

☒ E27 / 1x max. 60W
IP20 • 9082
9082
bronze/white



7993 (M) (G)

☒ E27 / 1x max. 60W
IP20 • 9083
bronze/white



7995 (M) (G)

☒ E27 / 2x max. 40W
IP20 • 9085
bronze/white





PETRONEL

WOOD



7072

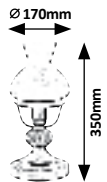

7079

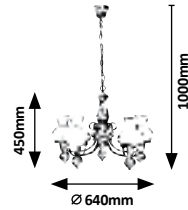

7078

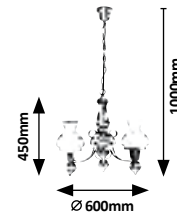

7077

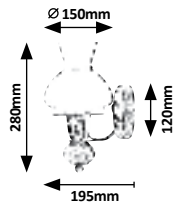

7076

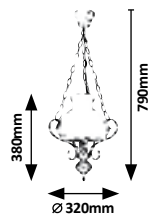

7072 MWG

☒ E27 / 1x max. 60W
IP20 • 9547 • matte black/walnut/
opal glass



S 36R25C 375720

7076 MWG

☒ E27 / 1x max. 60W
IP20 • 9516 • matte black/walnut/
opal glass



S 36R25C 375767

7077 MWG

☒ E27 / 1x max. 60W
IP20 • 9547 • matte black/walnut/
opal glass



S 36R25C 375774

7078 MWG

☒ E27 / 3x max. 60W
IP20 • 9547 • matte black/walnut/
opal glass



S 36R25C 375781

7079 MWG

☒ E27 / 5x max. 60W
IP20 • 9547 • matte black/walnut/
opal glass



S 36R25C 375798

WOOD



7868

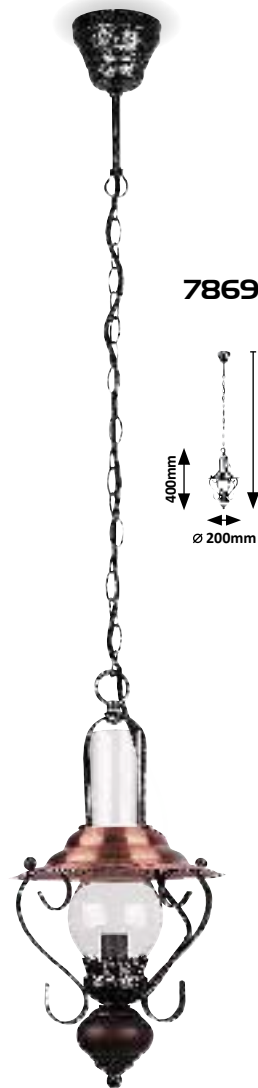

7869



7860

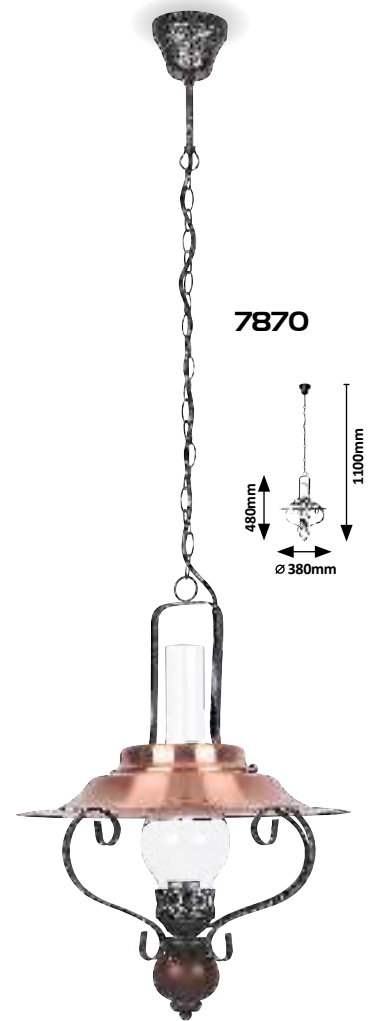

7870

7860 MWG

☒ E14 / 3x max. 40W
IP20 • 19194
black/bronze/walnut



S 392250 375202

7868 MWG

☒ E14 / 1x max. 40W
IP20 • 19194
black/bronze/walnut



S 392250 375228

7869 MWG

☒ E14 / 1x max. 40W
IP20 • 19194
black/bronze/walnut



S 392250 375205

7870 MWG

☒ E27 / 1x max. 60W
IP20 • 19210
black/bronze/walnut



S 392250 375701

MIRELLA

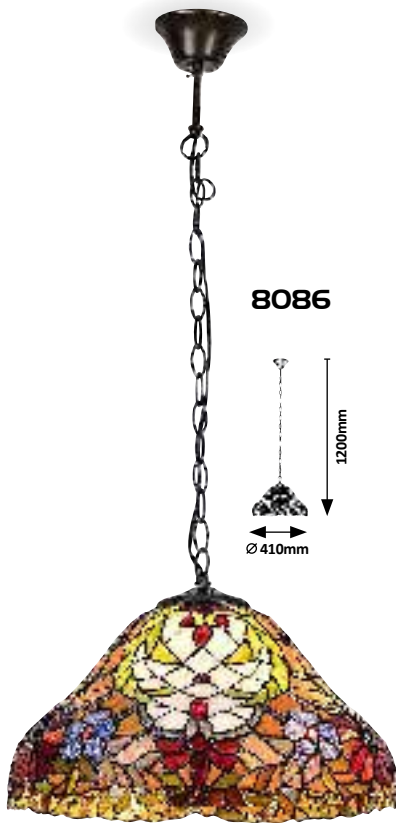

8086

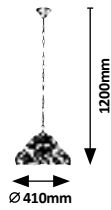

8087

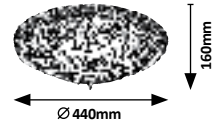

8088

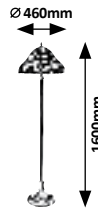

8089

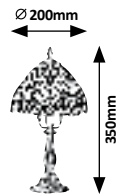

8090

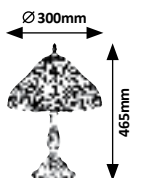

8086 (M G)

☒ E27 / 2x max. 60W
IP20 • 19182
bronze/multicolour



8087 (M G)

☒ E27 / 2x max. 60W
IP20 • 19183
bronze/multicolour



8088 (M G)

☒ E27 / 2x max. 60W
IP20 • 19181
bronze/multicolour



8089 (M G)

☒ E14 / 1x max. 40W
IP20 • 19179
bronze/multicolour



8090 (M G)

☒ E27 / 1x max. 60W
IP20 • 19180
bronze/multicolour





8091

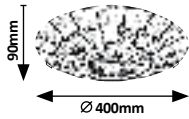

8078

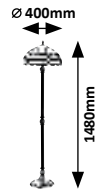

8072

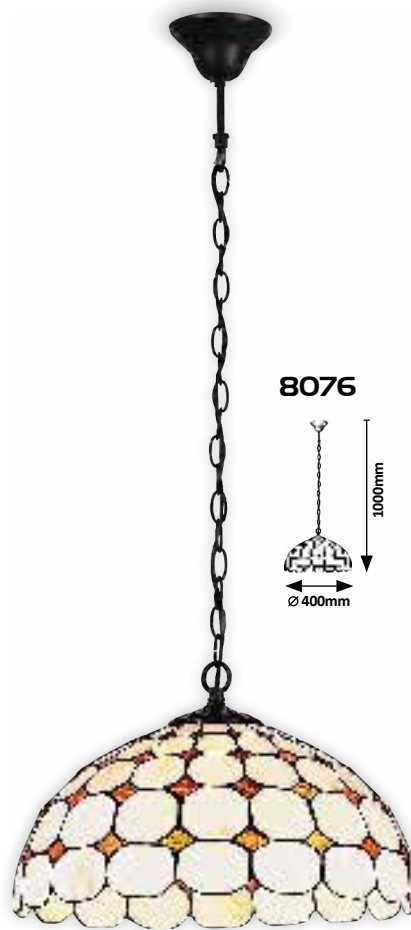
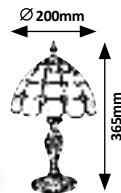

8076

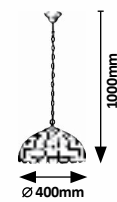

8072 (M) (G)

☒ E14 / 1x max. 40W
IP20 •
bronze/multicolour



8076 (M) (G)

☒ E27 / 2x max. 60W
IP20
bronze/multicolour



8078 (M) (G)

☒ E27 / 2x max. 60W
IP20 •
19370
bronze/multicolour



8091 (M) (G)

☒ E27 / 2x max. 60W
IP20 • 1218
bronze/multicolour



FABIOLA



7260



7261



7259



7260

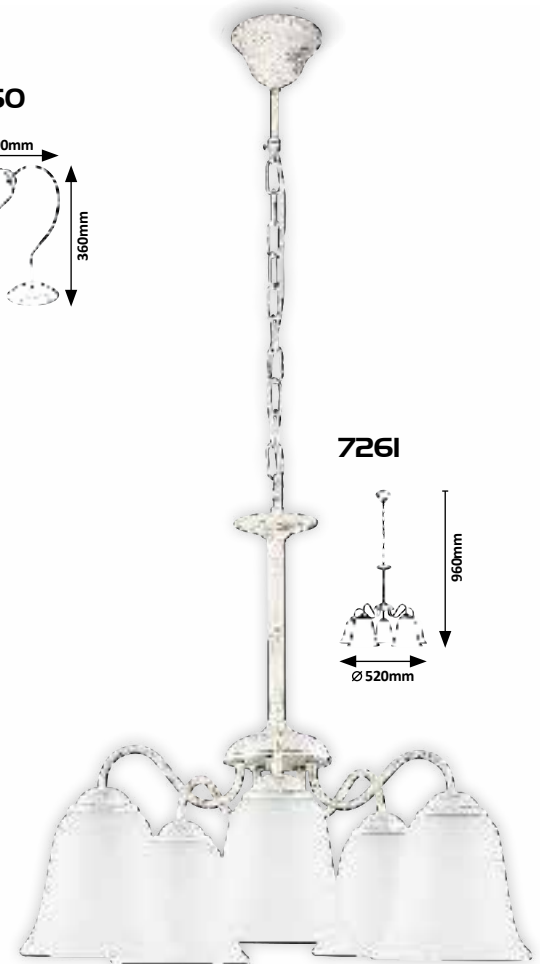

7261

7259 **M G**

☒ E27 / 1x max. 40W
IP20 • 19554
antique white/opal glass



S 36225C 7259-4

7260 **M G**

☒ E27 / 1x max. 40W
IP20 • 19554
antique white/opal glass



S 36225C 7260-0

7261 **M G**

☒ E27 / 5x max. 40W
IP20 • 19554
antique white/opal glass

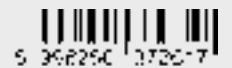

S 36225C 7261-7

DOROTHEA



7771

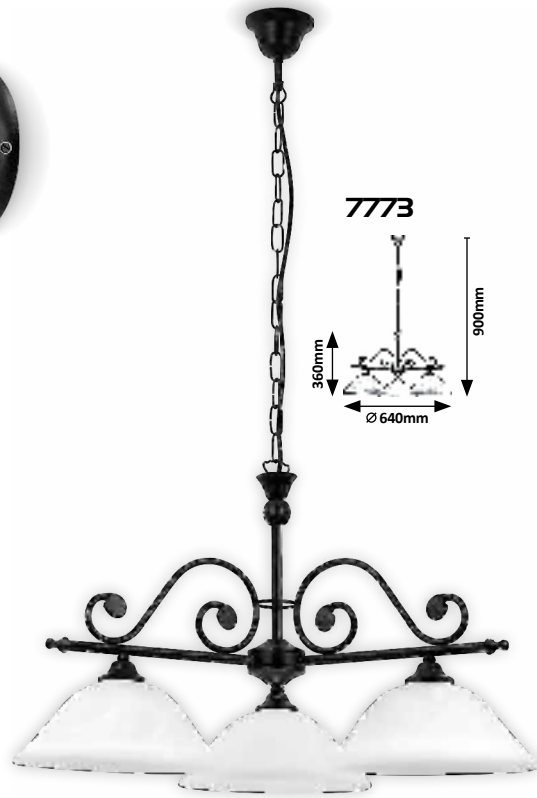
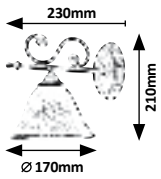

7773

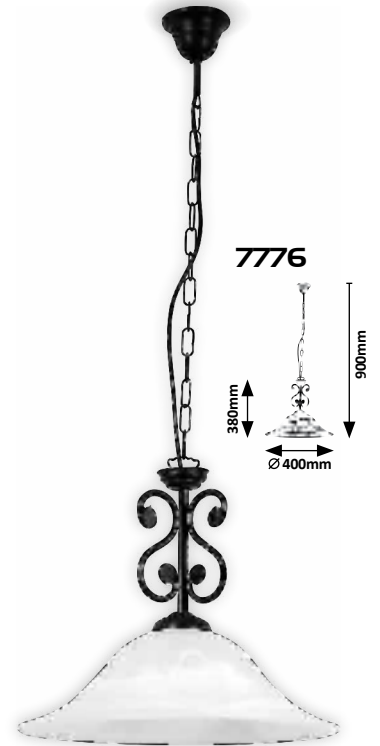
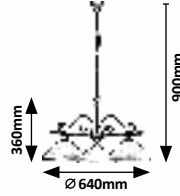

7776

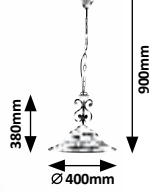

7772

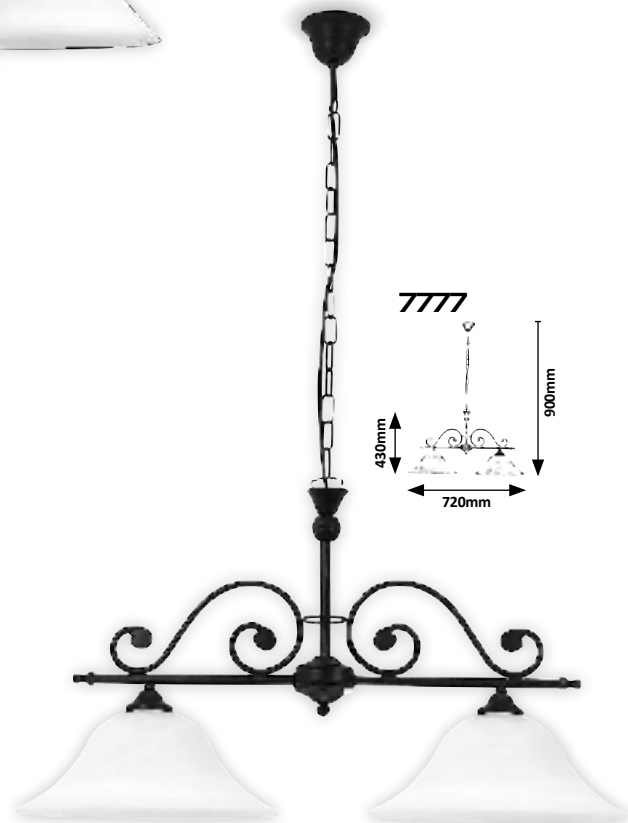
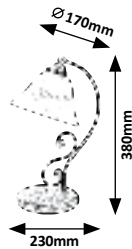

7777

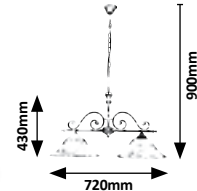

7771 **M G**

☒ E14 / 1x max. 40W
IP20 • 9421
black/white alabaster



7772 **M G**

☒ E14 / 1x max. 40W
IP20 • 9421
black/white alabaster



7773 **M G**

☒ E27 / 3x max. 60W
IP20 • 9295
black/white alabaster



7776 **M G**

☒ E27 / 1x max. 60W
IP20 • 9422
black/white alabaster



7777 **M G**

☒ E27 / 2x max. 60W
IP20 • 9423
black/white alabaster



ATHEN

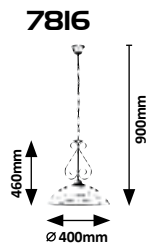
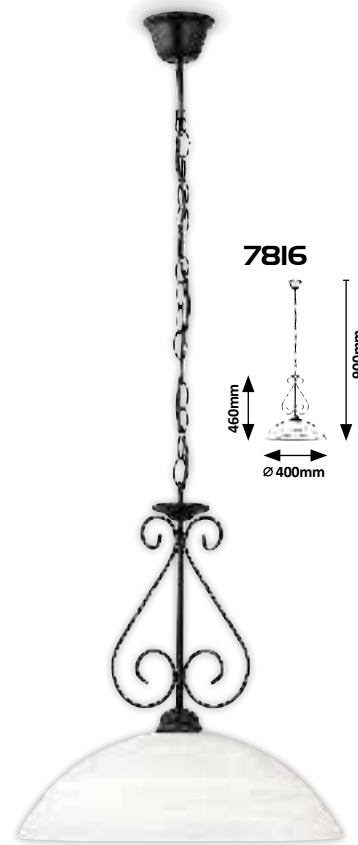
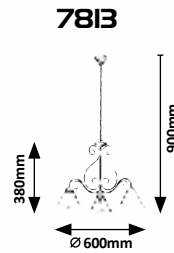
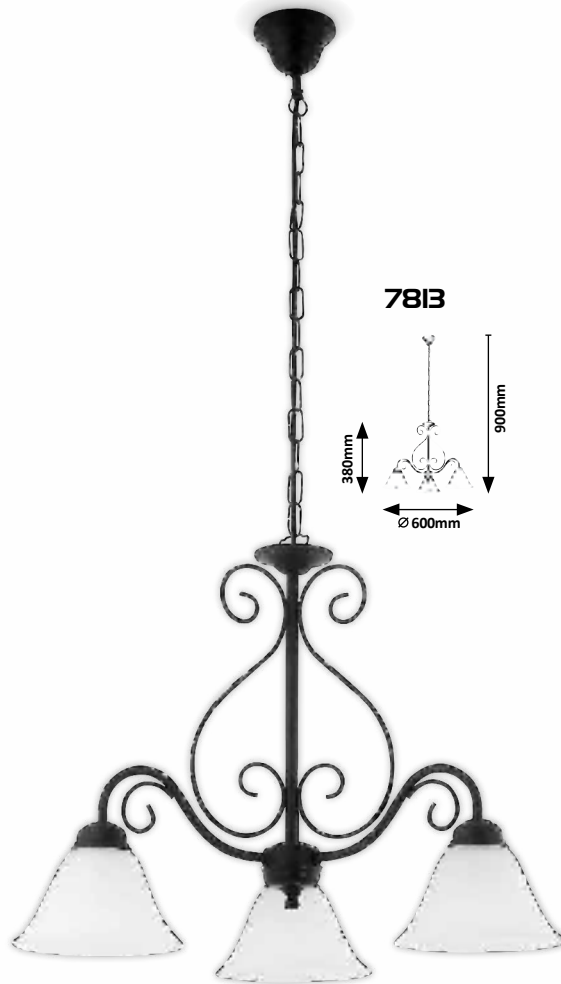
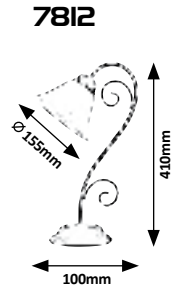
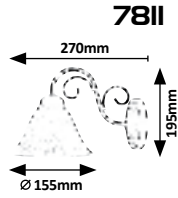

7811 (M) (G)

☒ E14 / 1x max. 40W
IP20 • 9290
black/white alabaster

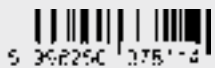

7812 (M) (G)

☒ E14 / 1x max. 40W
IP20 • 9290
black/white alabaster



7813 (M) (G)

☒ E14 / 3x max. 40W
IP20 • 9290
black/white alabaster



7816 (M) (G)

☒ E27 / 1x max. 60W
IP20 • 9571
black/white alabaster



ATHEN



3721

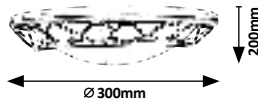

3722

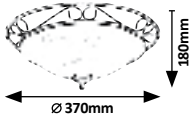

3723

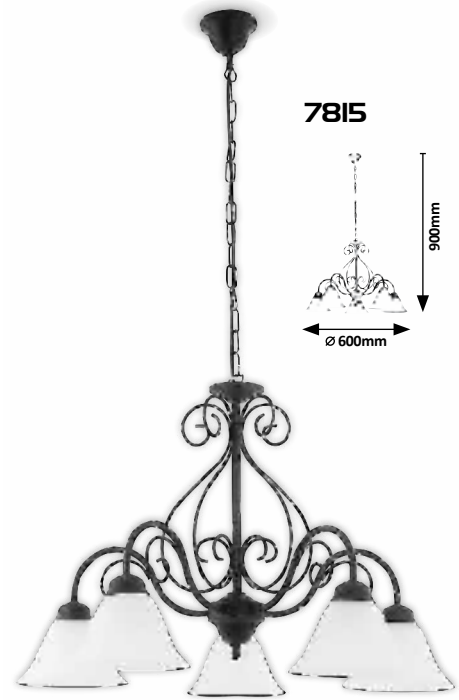
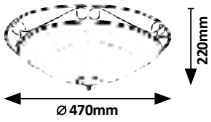

7815

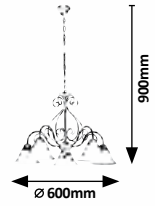

3721 (M) (G)

☒ E14 / 1x max. 60W
IP20 • 9572
black/white alabaster

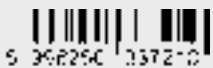

S 36R25C 337210

3722 (M) (G)

☒ E27 / 2x max. 60W
IP20 • 9573
black/white alabaster



S 36R25C 337227

3723 (M) (G)

☒ E27 / 3x max. 60W
IP20 • 9574
black/white alabaster



S 36R25C 337234

7815 (M) (G)

☒ E14 / 5x max. 40W
IP20 • 9290
black/white alabaster



S 36R25C 337112



LACEY

METAL
BLACK

5341

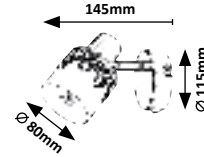

5342

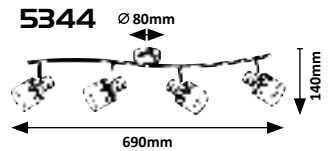
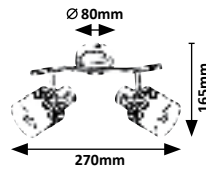

5341 (M) (G)

☒ E14 / 1x max. 40W
IP20 • 19825
black/white

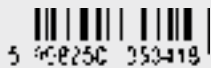

5342 (M) (G)

☒ E14 / 2x max. 40W
IP20 • 19825
black/white

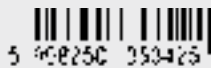

5344 (M) (G)

☒ E14 / 4x max. 40W
IP20 • 19825
black/white

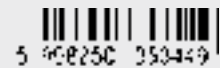

LACEY

METAL
BLACK

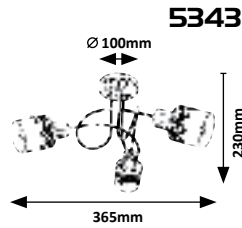

5345

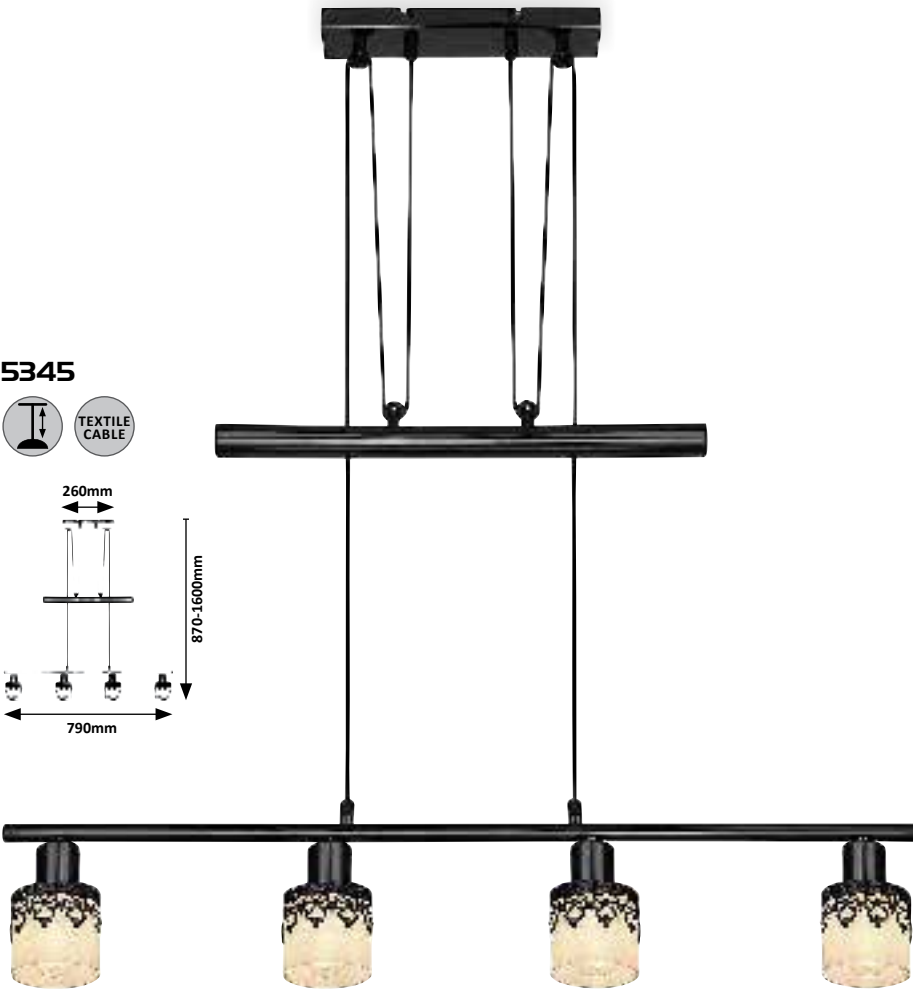
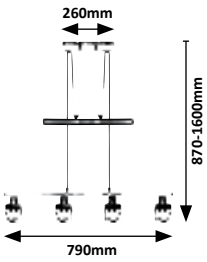
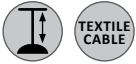

5343 (M) (G)

☒ E14 / 3x max. 40W
IP20 • 19825
black/white

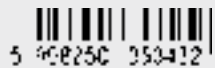

5345 (M) (G)

☒ E14 / 4x max. 40W
IP20 • 19825
black/white



ALESSANDRA

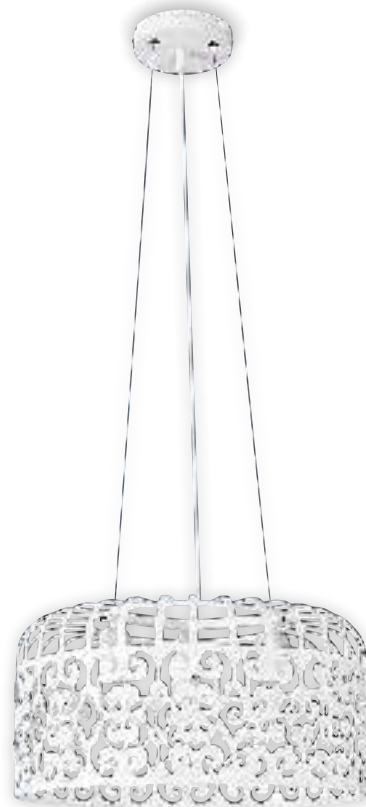
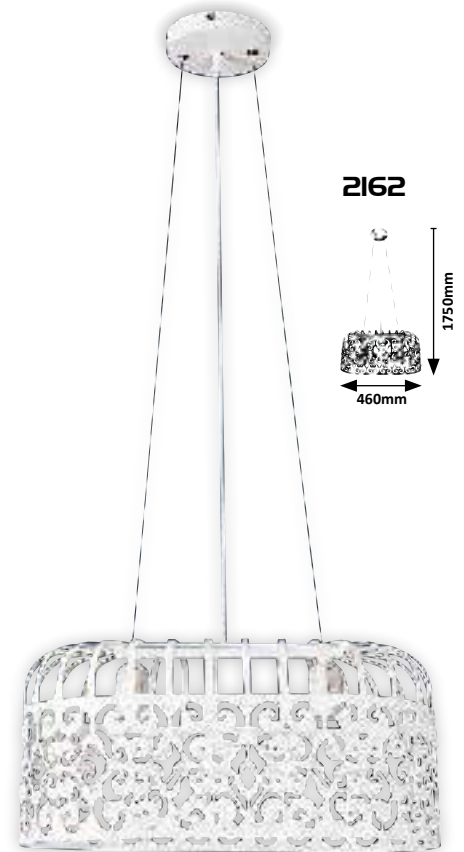
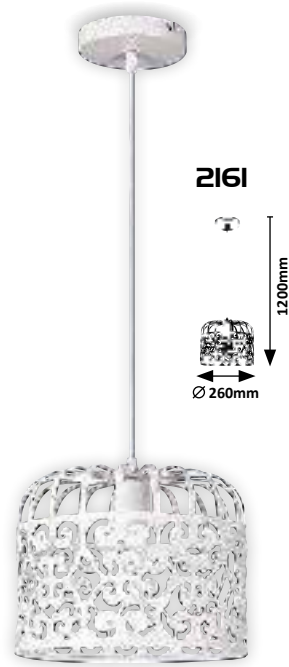

2161 **(M)**
☒ E27 / 1x max. 60W
IP20
matte white



2162 **(M)**
☒ E27 / 2x max. 60W
IP20
matte white



2163
☒ E27 / 3x max. 60W
IP20
matte white



ALESSANDRA

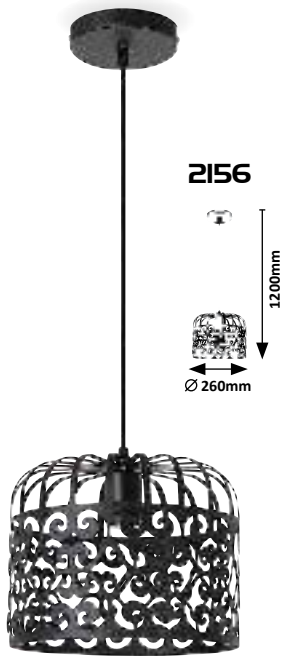

2156

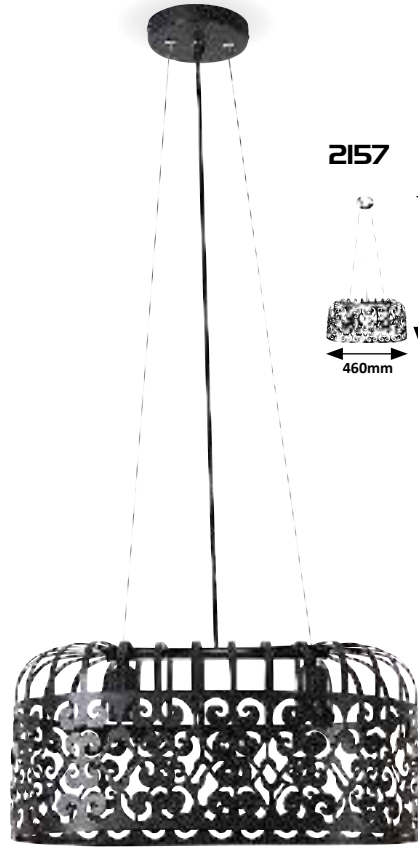
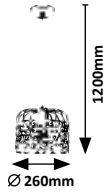

2157

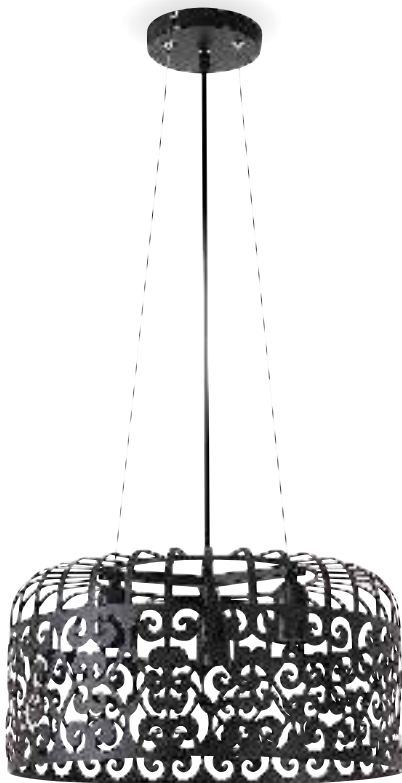
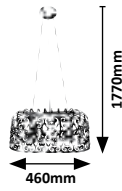

2158

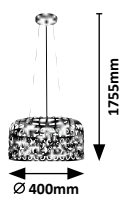

2156



☒ E27 / 1x max. 60W
IP20
matte black



S 36225C 12'571

2157



☒ E27 / 2x max. 60W
IP20
matte black



S 36225C 12'572

2158



☒ E27 / 3x max. 60W
IP20
matte black



S 36225C 12'585

02

SPOTS

SPOTOK

SPOTS



TARIEN



3248

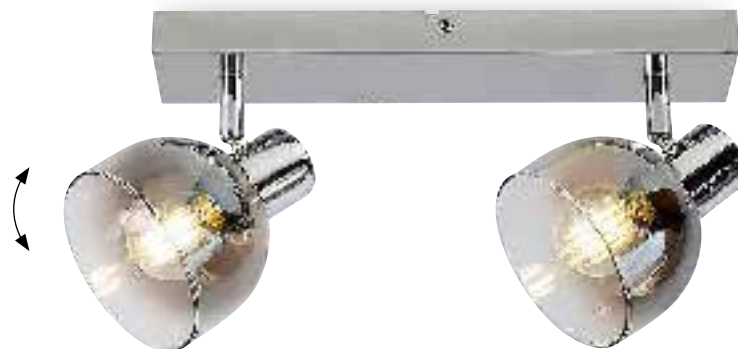
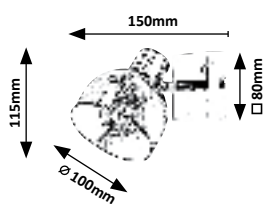

3249

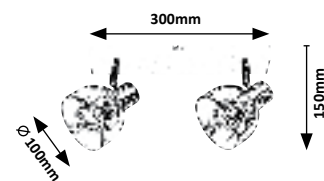

3250

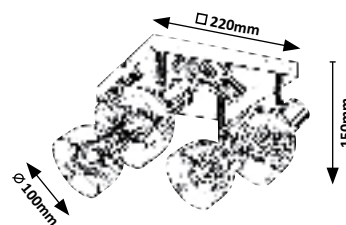

3248 **MG**

☒ E14 / 1x max. 40W
IP20 • 19999
chrome/tinted colour



3249 **MG**

☒ E14 / 2x max. 40W
IP20 • 19999
chrome/tinted colour



3250 **MG**

☒ E14 / 4x max. 40W
IP20 • 19999
chrome/tinted colour





SALAZAR

5397



5398

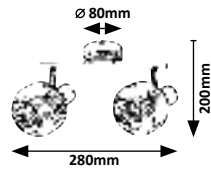

5346



5399

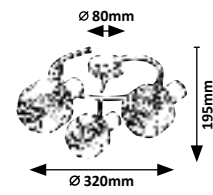

5400

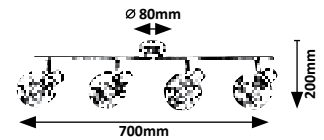

5397 **MG**

☒ E14 / 1x max. 40W
IP20 • 19787
oak/tinted colour



5398 **MG**

☒ E14 / 2x max. 40W
IP20 • 19787
oak/tinted colour

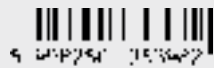

5399 **MG**

☒ E14 / 3x max. 40W
IP20 • 19787
oak/tinted colour

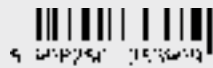

5400 **MG**

☒ E14 / 4x max. 40W
IP20 • 19787
oak/tinted colour

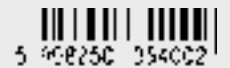

TAMARA



5346

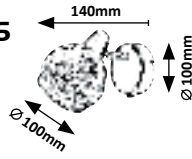

5347

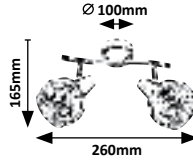

5348

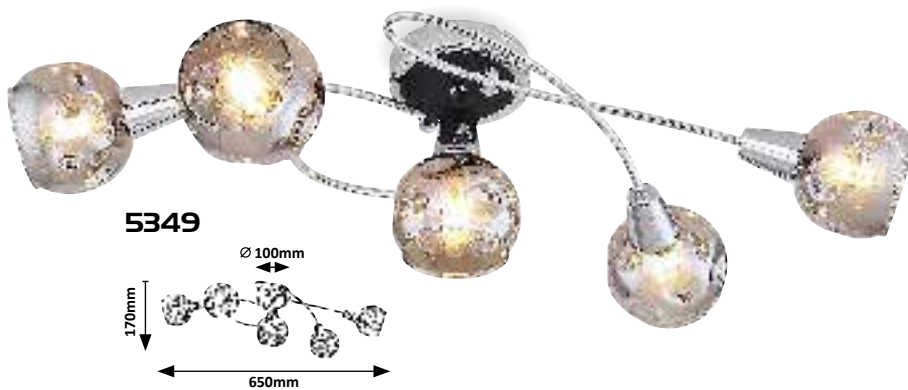
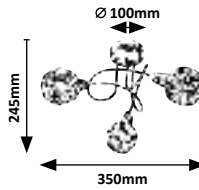

5349

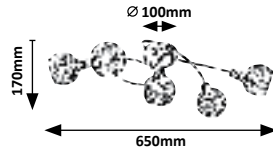

5346 **MG**

☒ E14 / 1x max. 40W
IP20 • 19867
chrome/tinted colour



9 392250 353403

5347 **MG**

☒ E14 / 2x max. 40W
IP20 • 19867
chrome/tinted colour

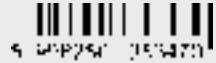

9 392250 353470

5348 **MG**

☒ E14 / 3x max. 40W
IP20 • 19867
chrome/tinted colour

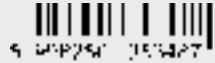

9 392250 353487

5349 **MG**

☒ E14 / 5x max. 40W
IP20 • 19867
chrome/tinted colour

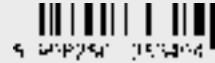

9 392250 353494

FEDORA

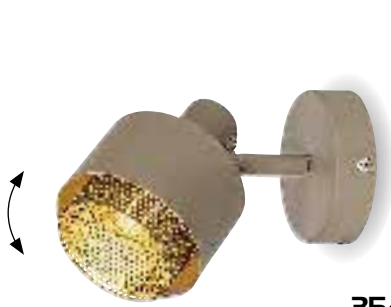

3547

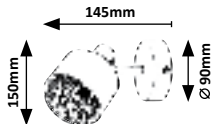

3548

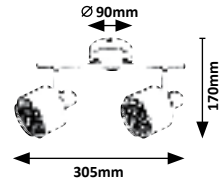

3549

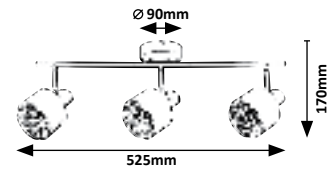

3550

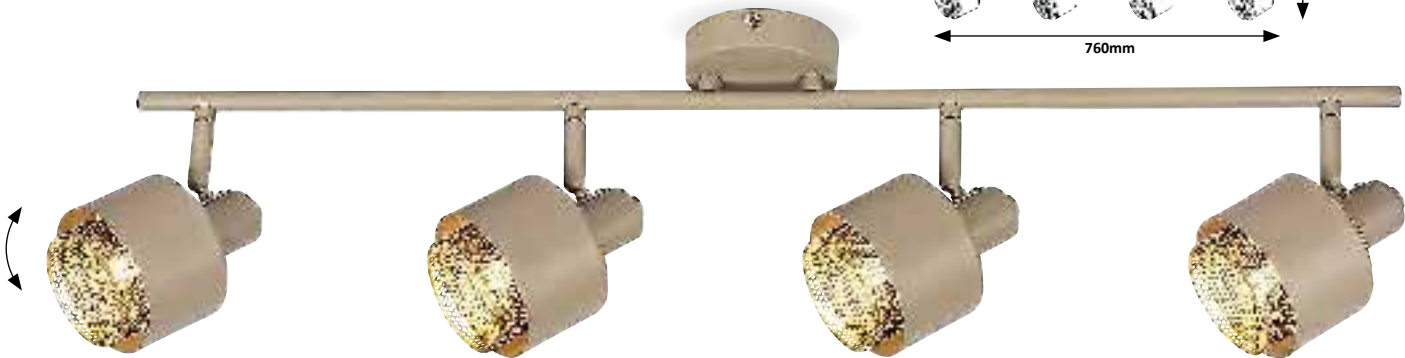
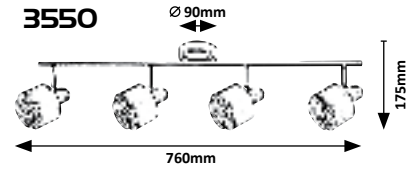

3547



☒ E14 / 1x max. 40W
IP20
brown/gold



5 902250 335470

3548



☒ E14 / 2x max. 40W
IP20
brown/gold

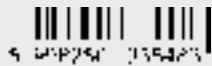

5 902250 335480

3549



☒ E14 / 3x max. 40W
IP20
brown/gold



5 902250 335490

3550



☒ E14 / 4x max. 40W
IP20
brown/gold

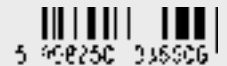

5 902250 335500

NATINA



5009

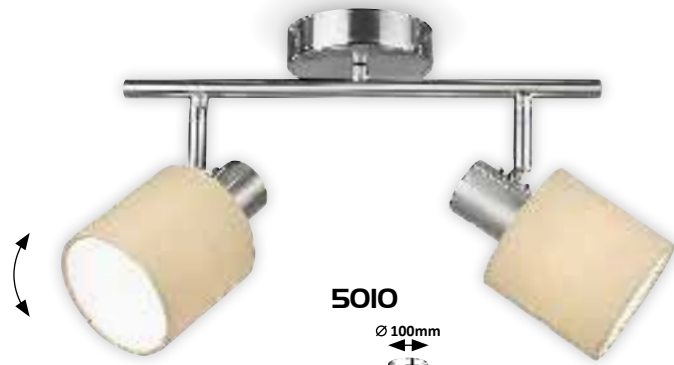
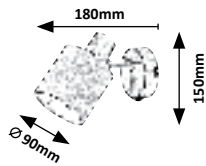

5010

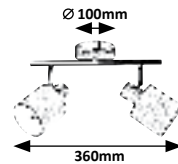

4980

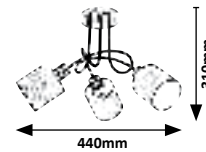

5011

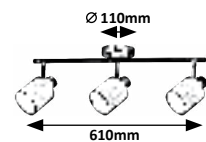

4980 (M) (T)

☒ E14 / 3x max. 25W
IP20 • 19886
beige/satin chrome



5 908250 349000

5009 (M) (T)

☒ E14 / 1x max. 25W
IP20 • 19774
beige/satin chrome



5 908250 350097

5010 (M) (T)

☒ E14 / 2x max. 25W
IP20 • 19774
beige/satin chrome



5 908250 350100

5011 (M) (T)

☒ E14 / 3x max. 25W
IP20 • 19774
beige/satin chrome

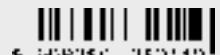

5 908250 350110

GAVIN

WOOD

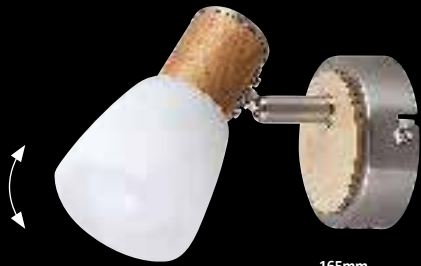

6486

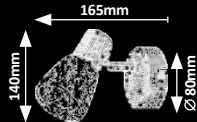

6487

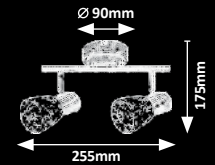

6488

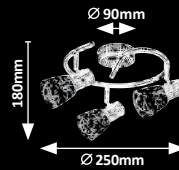

5539

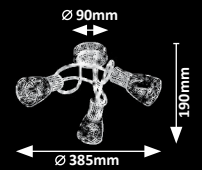

6489

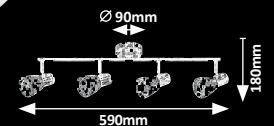

5539 MWG

☒ E14 / 3x max. 40W
IP20 • 19495
satin chrome/white



6486 MWG

☒ E14 / 1x max. 40W
IP20 • 19495
satin chrome/white



6487 MWG

☒ E14 / 2x max. 40W
IP20 • 19495
satin chrome/white



6488 MWG

☒ E14 / 3x max. 40W
IP20 • 19495
satin chrome/white



6489 MWG

☒ E14 / 4x max. 40W
IP20 • 19495
satin chrome/white



KAREN

5 YEAR WARRANTY
LED built-in
WARM White



5564

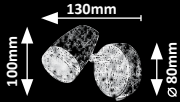

5565

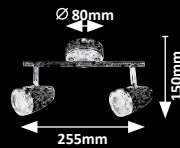

5566

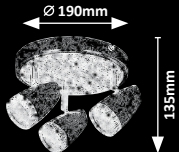

5567

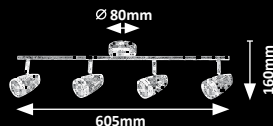

5564 (M P)

LED / 4W
(280lm, 3000K) incl.
IP20 •
white/beech



S 36R25C 355241

5565 (M P)

LED / 8W
(560lm, 3000K) incl.
IP20
white/beech



S 36R25C 355278

5566 (M P)

LED / 12W
(840lm, 3000K) incl.
IP20
white/beech



S 36R25C 355275

5567 (M P)

LED / 16W
(1120lm, 3000K) incl.
IP20
white/beech



S 36R25C 355272



SOLANGE



5045

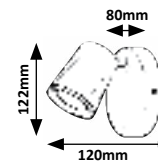

5046

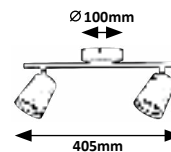

5047

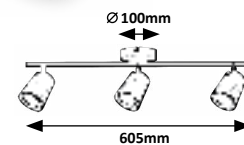

5048

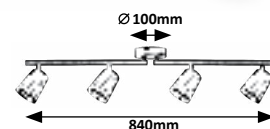

5045



LED / 6W
(380lm, 3000K) incl.
IP20 •
white/gold



5 908250 350413

5046



LED / 12W
(760lm, 3000K) incl.
IP20
white/gold

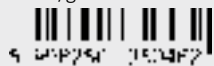

5 908250 350417

5047



LED / 18W
(1140lm, 3000K) incl.
IP20
white/gold



5 908250 350479

5048



LED / 24W
(1520lm, 3000K) incl.
IP20
white/gold

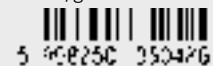

5 908250 350476

EBONY

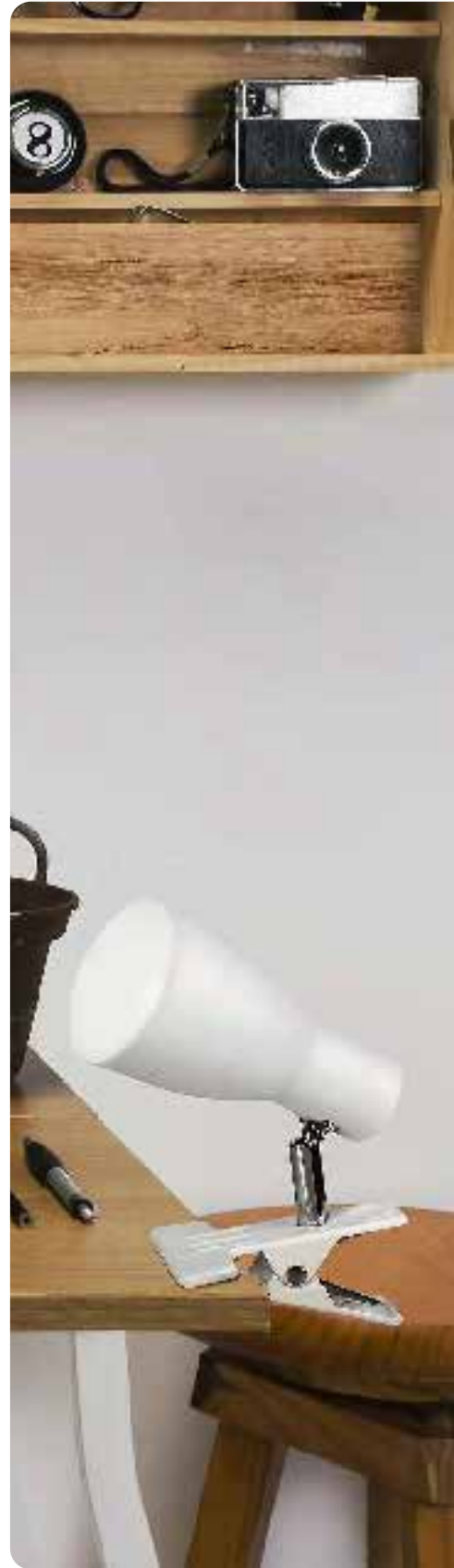
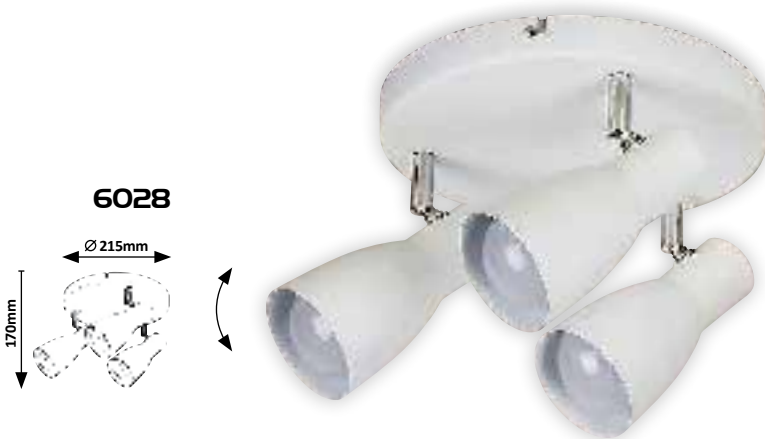

6025 (M)
 E27 / 1x max. 20W
 IP20 •
 white



6026 (M)
 E27 / 1x max. 20W
 IP20 •
 white



6027 (M)
 E27 / 2x max. 20W
 IP20 •
 white



6028 (M)
 E27 / 3x max. 20W
 IP20
 white



VIVIENNE



5966

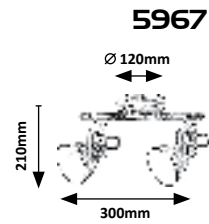

5967

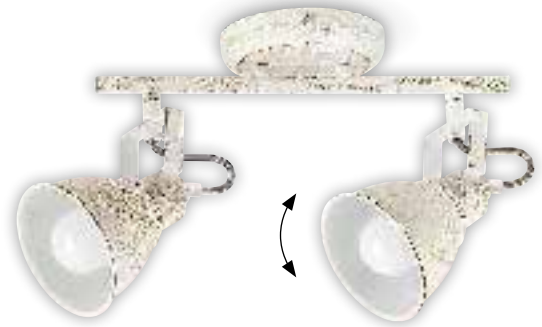

5969

5968

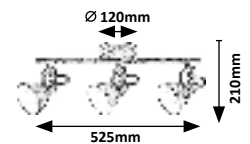

5966



☒ E14 / 1x max. 15W
IP20 • antique white



S 398296 753673

5967



☒ E14 / 2x max. 40W
IP20 antique white



S 398296 753670

5968



☒ E14 / 3x max. 40W
IP20 antique white



S 398296 753627

5969



☒ E14 / 4x max. 40W
IP20 antique white



S 398296 753694

VIVIENNE



5962

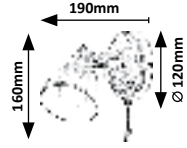

5963

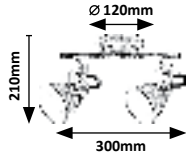

5965

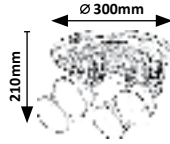

5964

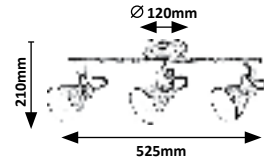

5966



5962



5962 (M)

☒ E14 / 1x max. 15W
IP20 • antique brown



S 398250 753025

5963 (M)

☒ E14 / 2x max. 40W
IP20 antique brown



S 398250 753022

5964 (M)

☒ E14 / 3x max. 40W
IP20 antique brown



S 398250 753020

5965 (M)

☒ E14 / 4x max. 40W
IP20 antique brown



S 398250 753026

KONRAD

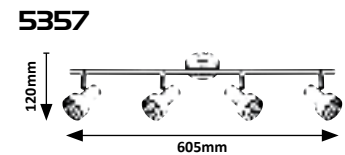
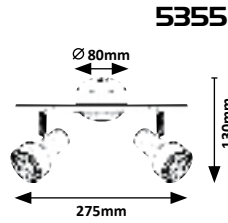

5354 (M)
 ☒ GU10 / 1x max. 50W
 IP20
 white



5 362250 053546

5355 (M)
 ☒ GU10 / 2x max. 50W
 IP20
 white

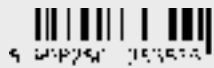

5 362250 053554

5356 (M)
 ☒ GU10 / 3x max. 50W
 IP20
 white

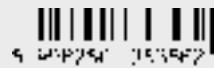

5 362250 053562

5357 (M)
 ☒ GU10 / 4x max. 50W
 IP20
 white



5 362250 053570

KONRAD

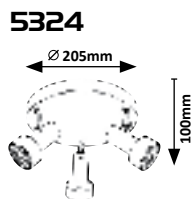

5322 **(M)**
☒ GU10 / 1x max. 50W
IP20
black



5323 **(M)**
☒ GU10 / 2x max. 50W
IP20
black

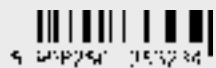

5324 **(M)**
☒ GU10 / 3x max. 50W
IP20
black

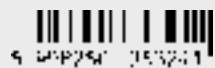

5325 **(M)**
☒ GU10 / 4x max. 50W
IP20
black



6666



KAREN



6666

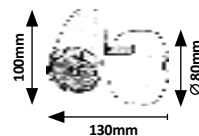

6667

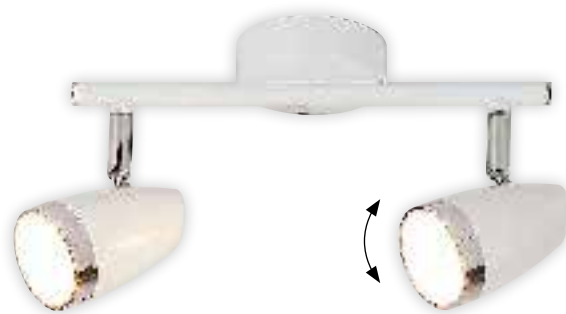
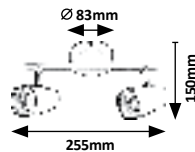

6512



6668

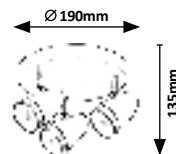

6669

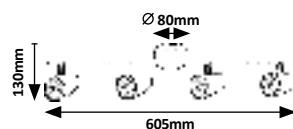

6666 (M) (P)

LED / 4W
(280lm, 3000K) incl.
IP20 •
white/chrome



S 36R25C 36021

6667 (M) (P)

LED / 8W
(560lm, 3000K) incl.
IP20
white/chrome



S 36R25C 36027E

6668 (M) (P)

LED / 12W
(840lm, 3000K) incl.
IP20
white/chrome



S 36R25C 36028D

6669 (M) (P)

LED / 16W
(1120lm, 3000K) incl.
IP20
white/chrome



S 36R25C 360292

KAREN

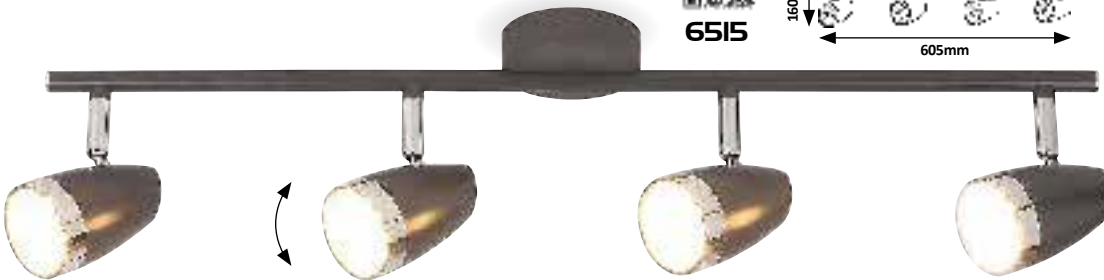
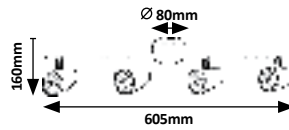
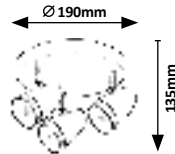
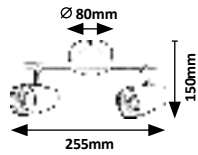
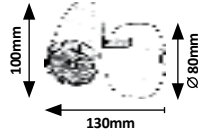

6512 (M P)

LED / 4W
(280lm, 3000K) incl.
IP20 • anthracite/chrome



S 392250 065121

6513 (M P)

LED / 8W
(560lm, 3000K) incl.
IP20 anthracite/chrome



S 392250 065132

6514 (M P)

LED / 12W
(840lm, 3000K) incl.
IP20 anthracite/chrome



S 392250 065143

6515 (M P)

LED / 16W
(1120lm, 3000K) incl.
IP20 anthracite/chrome



S 392250 065154



SOLO

New



2081



2082



2083

2081 (M)
 ☒ GU10 / 1x max. 25W
 IP20 • □
 white



2082 (M)
 ☒ GU10 / 2x max. 25W
 IP20
 white



2083 (M)
 ☒ GU10 / 4x max. 25W
 IP20
 white



SOLO

New



2084

(M)

☒ GU10 / 1x max. 25W
IP20 • □
black



2085

(M)

☒ GU10 / 2x max. 25W
IP20
black



2086

(M)

☒ GU10 / 4x max. 25W
IP20
black



KONRAD

New



730II (M)
 ☒ GU10 / 1x max. 50W
 IP20
 matte black/silver



730I2 (M)
 ☒ GU10 / 2x max. 50W
 IP20
 matte black/silver



730I3 (M)
 ☒ GU10 / 3x max. 50W
 IP20
 matte black/silver



730I4 (M)
 ☒ GU10 / 4x max. 50W
 IP20
 matte black/silver



ABERAMA

PLASTIC

New



73001

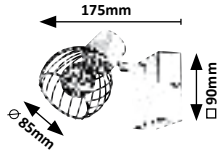

73002

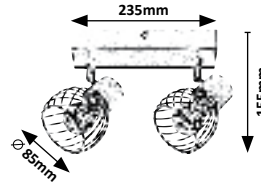

73003

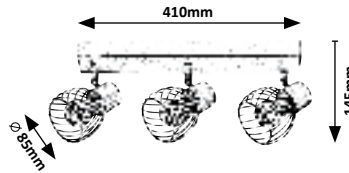

73004

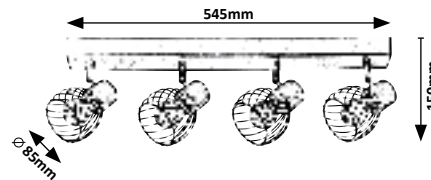

73001 (P)

⊗ E14 / 1x max. 10W
IP20
black



73002 (P)

⊗ E14 / 2x max. 10W
IP20
black



73003 (P)

⊗ E14 / 3x max. 10W
IP20
black



73004 (P)

⊗ E14 / 4x max. 10W
IP20
black



EDMUND



5295

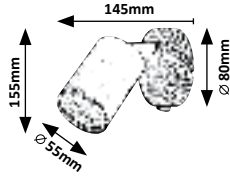

5296

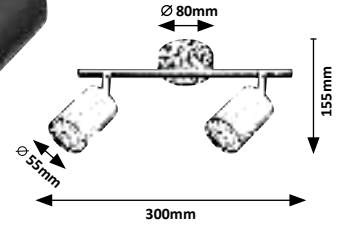

5297

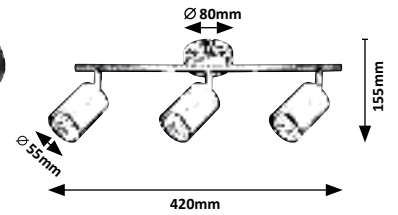

5298

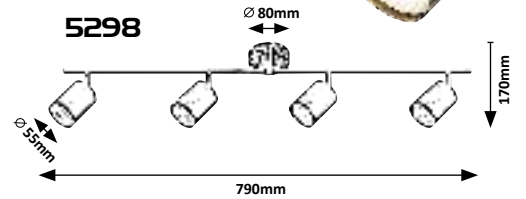

5295



☒ GU10 / 1x max. 25W
IP20 •
oak/black



S 368290 352374

5296



☒ GU10 / 2x max. 25W
IP20
oak/black



S 368290 352376

5297



☒ GU10 / 3x max. 25W
IP20
oak/black



S 368290 352378

5298



☒ GU10 / 4x max. 25W
IP20
oak/black



S 368290 352380

MAC



5902

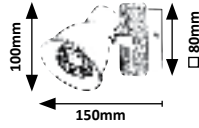

5903

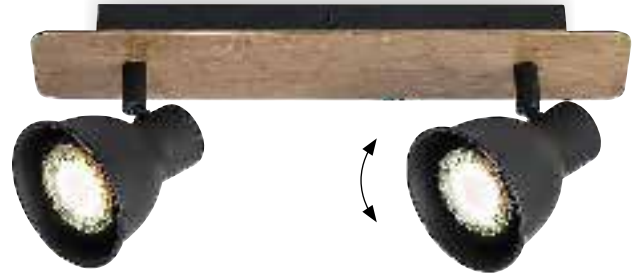
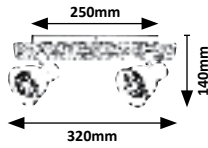

5905

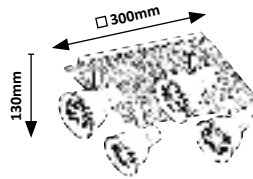

5904

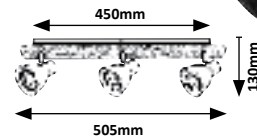

5902



☒ GU10 / 1x max. 15W
IP20 • □
black/beech



S 362250 353021

5903



☒ GU10 / 2x max. 15W
IP20 • □
black/beech



S 362250 353076

5904



☒ GU10 / 3x max. 35W
IP20
black/beech



S 362250 353043

5905



☒ GU10 / 4x max. 35W
IP20
black/beech



S 362250 353072

ZEUS

WOOD



3137

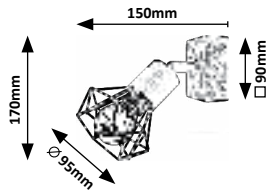

3138

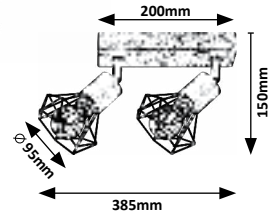

3139

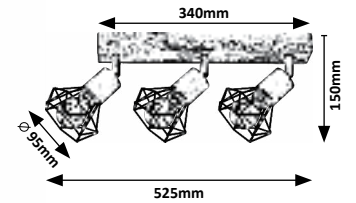

3140

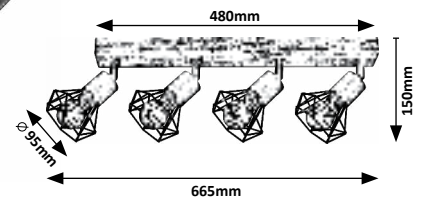

3137 (M) (W)

☒ E14 / 1x max. 40W
IP20
oak/matte black



3138 (M) (W)

☒ E14 / 2x max. 40W
IP20
oak/matte black



3139 (M) (W)

☒ E14 / 3x max. 40W
IP20
oak/matte black



3140 (M) (W)

☒ E14 / 4x max. 40W
IP20
oak/matte black

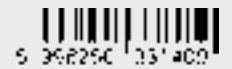

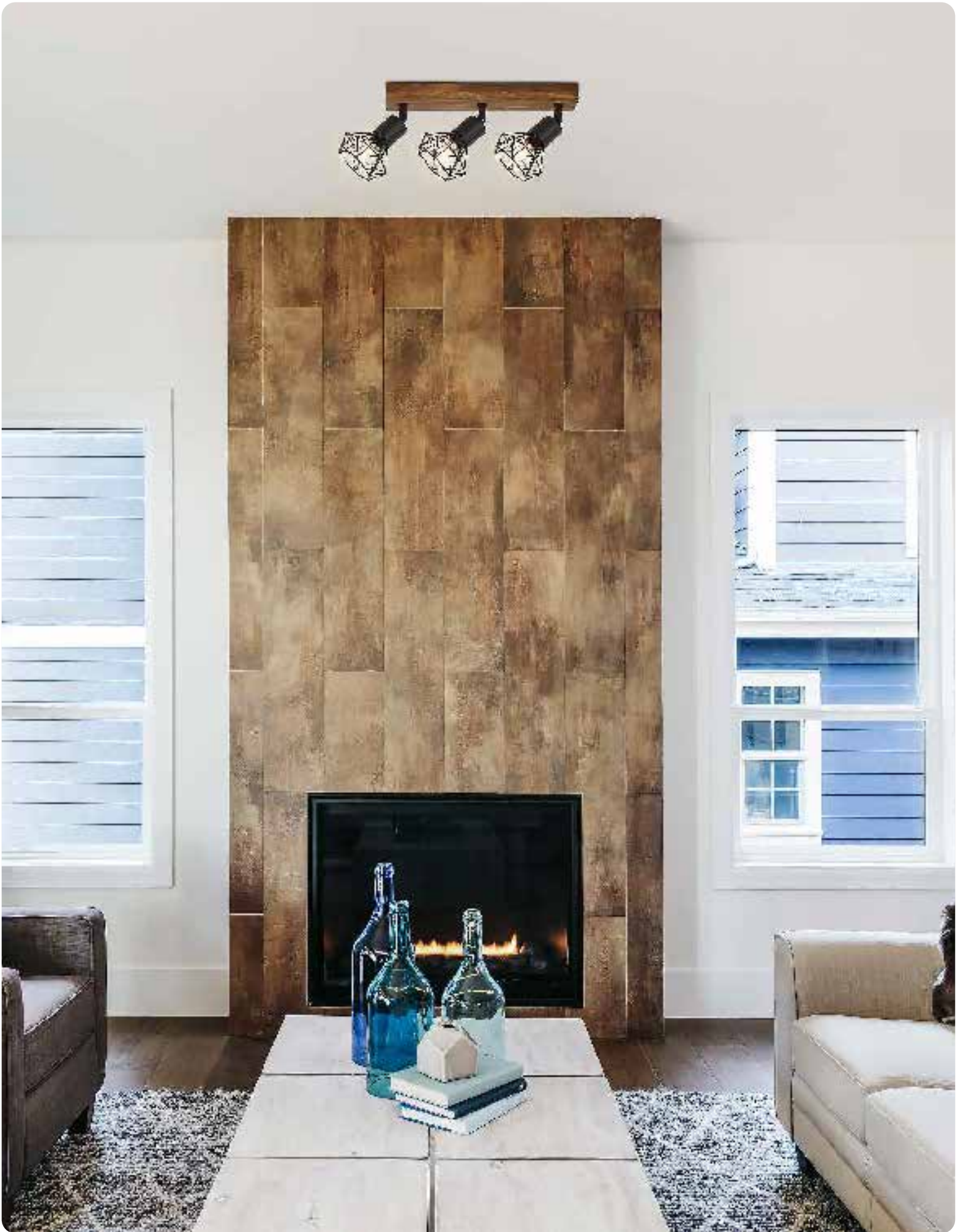

BLAKE



3183

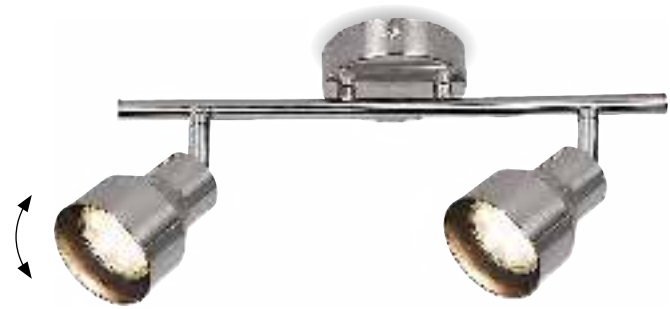
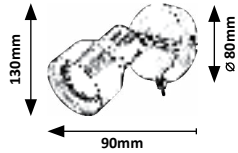

3184

Ø 80mm

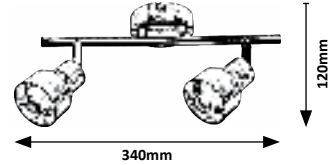

3185

Ø 90mm

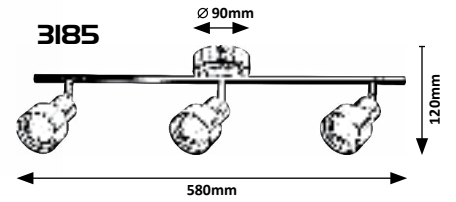

3186

Ø 90mm

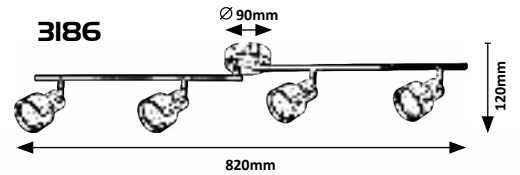

3183

(M)

☒ GU10 / 1x max. 50W
IP20 • satin chrome

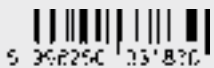

5 362250 031830

3184

(M)

☒ GU10 / 2x max. 50W
IP20 satin chrome



5 362250 031843

3185

(M)

☒ GU10 / 3x max. 50W
IP20 satin chrome



5 362250 031850

3186

(M)

☒ GU10 / 4x max. 50W
IP20 satin chrome



5 362250 031867

MERKUR

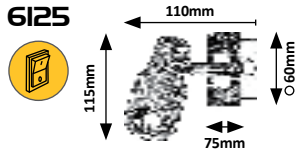

6128

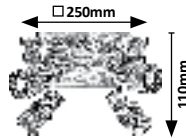

6127

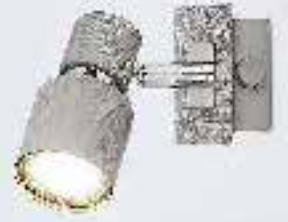
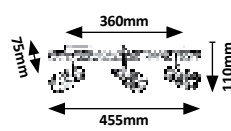

6125



☒ GU10 / 1x max. 50W
IP20 •
silver oak/chrome



S 36225C 36'213

6126



☒ GU10 / 2x max. 50W
IP20 •
silver oak/chrome



S 36226C 36'210

6127



☒ GU10 / 3x max. 50W
IP20
silver oak/chrome



S 36227C 36'217

6128



☒ GU10 / 4x max. 50W
IP20
silver oak/chrome



S 36228C 36'214

NORMAN

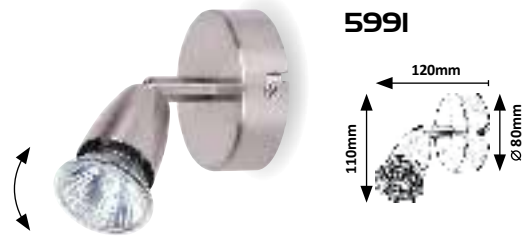

5991

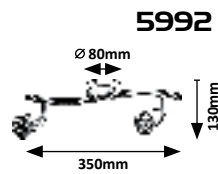

5992



5993

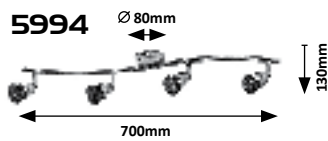

5994



5991 **(M)**
 ☒ GU10 / 1x max. 50W
 IP20
 satin chrome



5992 **(M)**
 ☒ GU10 / 2x max. 50W
 IP20
 satin chrome



5993 **(M)**
 ☒ GU10 / 3x max. 50W
 IP20
 satin chrome



5994 **(M)**
 ☒ GU10 / 4x max. 50W
 IP20
 satin chrome



NORMAN



5995

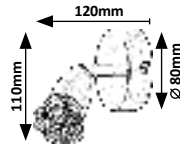

5996

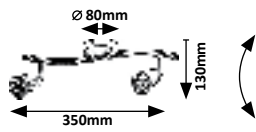

5991



5997

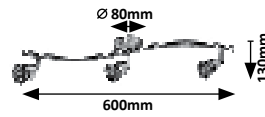

5995



5998



5995



☒ GU10 / 1x max. 50W
IP20
bronze



S 36R25C 353073

5996



☒ GU10 / 2x max. 50W
IP20
bronze



S 36R25C 353076

5997



☒ GU10 / 3x max. 50W
IP20
bronze



S 36R25C 353077

5998



☒ GU10 / 4x max. 50W
IP20
bronze



S 36R25C 353074

NORTON LED

LED
incl.

WARM
White

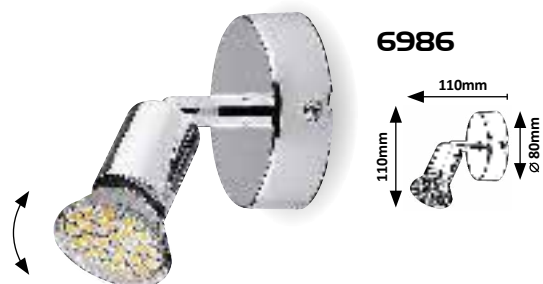

6986

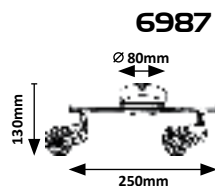

6987



6989

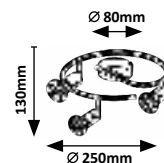

6988

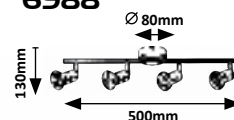

6986

(M)

LED / 3W
(250lm, 3000K) incl.
GU10 / 1x max. 50W
IP20 • chrome



S 392250 063870

6987

(M)

LED / 6W
(500lm, 3000K) incl.
GU10 / 2x max. 50W
IP20 • chrome



S 392250 063877

6988

(M)

LED / 12W
(1000lm, 3000K) incl.
GU10 / 4x max. 50W
IP20 • chrome



S 392250 063884

6989

(M)

LED / 9W
(750lm, 3000K) incl.
GU10 / 3x max. 50W
IP20 • chrome



S 392250 063891

NORTON



6045



6046



6048



6047



6045 (M)
 GU10 / 1x max. 50W
 IP20
 chrome



S 398250 060404

6046 (M)
 GU10 / 2x max. 50W
 IP20
 chrome



S 398250 060401

6047 (M)
 GU10 / 4x max. 50W
 IP20
 chrome



S 398250 060407

6048 (M)
 GU10 / 3x max. 50W
 IP20
 chrome



S 398250 060408

LOGAN



6096



5631



6096

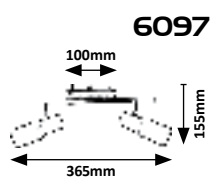

6097



6098

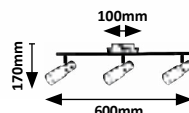

6099

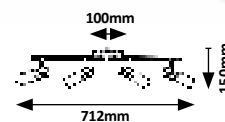

6096 **M G**

☒ E14 / 1x max. 40W
IP20 • 19249
chrome/white



S 392250 760300

6097 **M G**

☒ E14 / 2x max. 40W
IP20 • 19249
chrome/white



S 392250 760303

6098 **M G**

☒ E14 / 3x max. 40W
IP20 • 19249
chrome/white



S 392250 760300

6099 **M G**

☒ E14 / 4x max. 40W
IP20 • 19249
chrome/white



S 392250 760307

FINIAN



5631

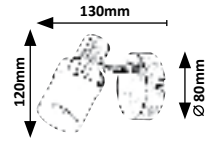

5632

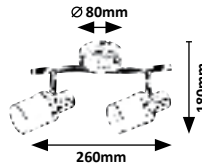

5633

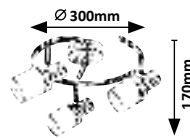

5634

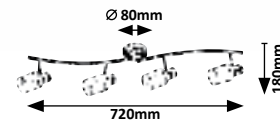

5631 (M) (G)

☒ E14 / 1x max. 40W
IP20 • 19633
satin chrome/opal glass



5632 (M) (G)

☒ E14 / 2x max. 40W
IP20 • 19633
satin chrome/opal glass



5633 (M) (G)

☒ E14 / 3x max. 40W
IP20 • 19633
satin chrome/opal glass



5634 (M) (G)

☒ E14 / 4x max. 40W
IP20 • 19633
satin chrome/opal glass



NICOLETTE

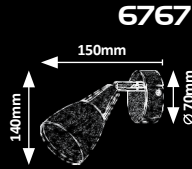

6767

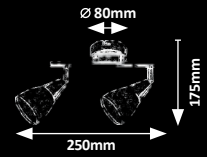

6768

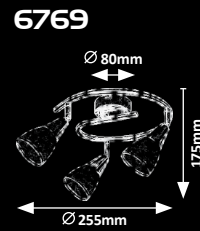

6769

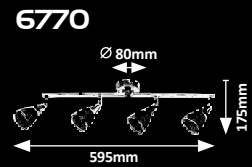
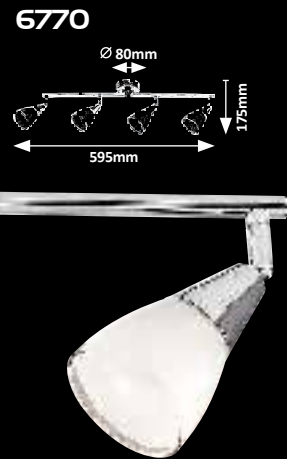

6770

6767 **MG**

☒ E14 / 1x max. 40W
IP20 • 19423
chrome/white



6768 **MG**

☒ E14 / 2x max. 40W
IP20 • 19423
chrome/white



6769 **MG**

☒ E14 / 3x max. 40W
IP20 • 19423
chrome/white



6770 **MG**

☒ E14 / 4x max. 40W
IP20 • 19423
chrome/white



AUREL



6341

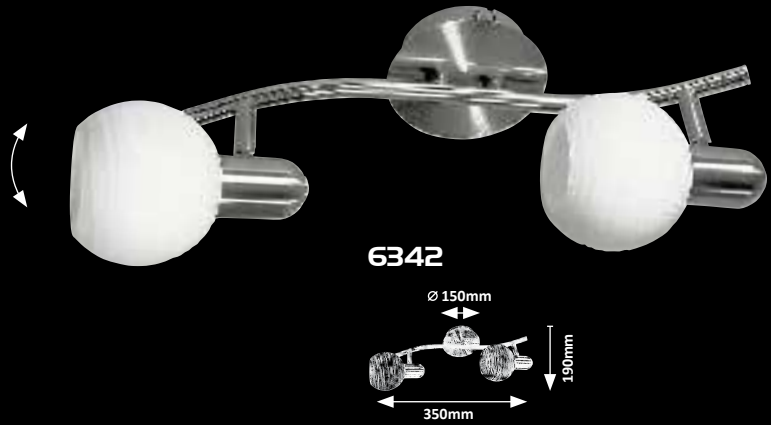

6342



6343



6344

6341 **MG**

☒ E14 / 1x max. 40W
IP20 • 19061
satin chrome/white



S 392250 063417

6342 **MG**

☒ E14 / 2x max. 40W
IP20 • 19061
satin chrome/white



S 392250 063422

6343 **MG**

☒ E14 / 3x max. 40W
IP20 • 19061
satin chrome/white



S 392250 063431

6344 **MG**

☒ E14 / 4x max. 40W
IP20 • 19061
satin chrome/white



S 392250 063442

DAVE



6835

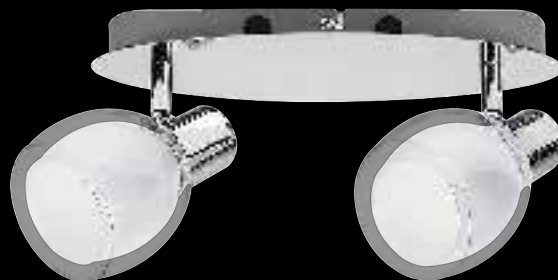
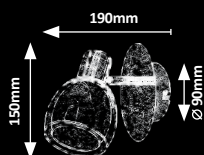

6836

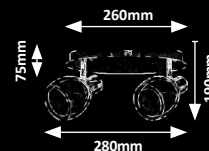

6837

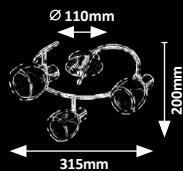

6081

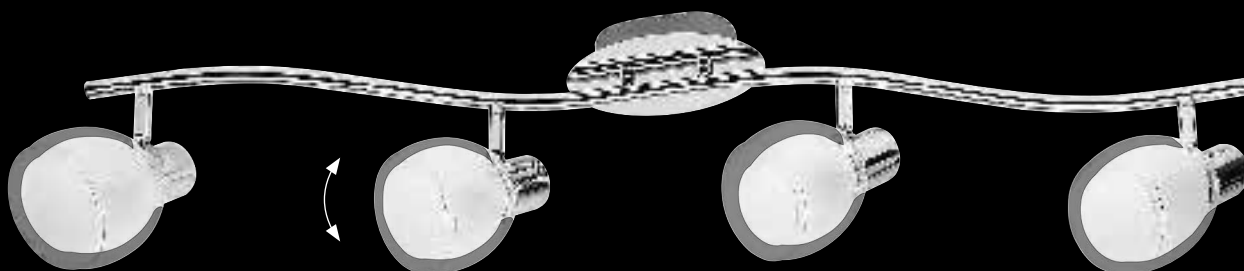
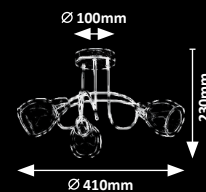

6838

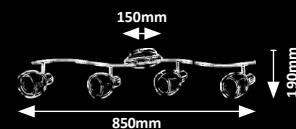

6835 **MG**

☒ E14 / 1x max. 40W
IP20 • □
▣ 19242 • ▣ 19193
chrome/white



S 392250 065371

6836 **MG**

☒ E14 / 2x max. 40W
IP20 • □
▣ 19242 • ▣ 19193
chrome/white



S 392250 065372

6837 **MG**

☒ E14 / 3x max. 40W
IP20
▣ 19242 • ▣ 19193
chrome/white



S 392250 065373

6838 **MG**

☒ E14 / 4x max. 40W
IP20
▣ 19242 • ▣ 19193
chrome/white



S 392250 065372

6081 **MG**

☒ E14 / 3x max. 40W
IP20
▣ 19242 • ▣ 19193
chrome/white



S 392250 0608-2

DAVE

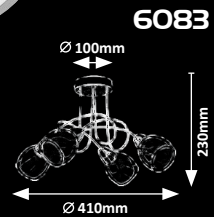

6083

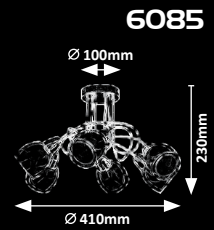

6085

LAUREN

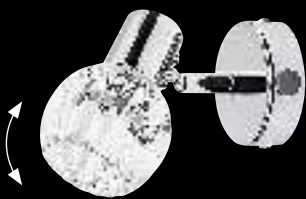

6091

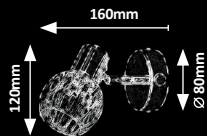

6092

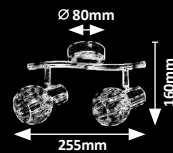

6093

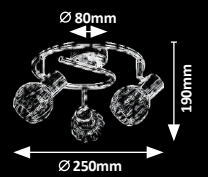

6094

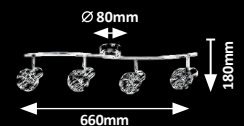

6083 **M G**

☒ E14 / 4x max. 40W
IP20
☐ 19242 • ◼ 19193
chrome/white



S 36225C 360830

6085 **M G**

☒ E14 / 6x max. 40W
IP20
☐ 19242 • ◼ 19193
chrome/white



S 36225C 360850

6091 **M G**

☒ E14 / 1x max. 40W
IP20 • ◼ 19321
chrome/transparent



S 36225C 360911

6092 **M G**

☒ E14 / 2x max. 40W
IP20 • ◼ 19321
chrome/transparent



S 36225C 360922

6093 **M G**

☒ E14 / 3x max. 40W
IP20 • ◼ 19321
chrome/transparent



S 36225C 360933

6094 **M G**

☒ E14 / 4x max. 40W
IP20 • ◼ 19321
chrome/transparent



S 36225C 360942

JENNA



5532

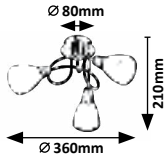

5533

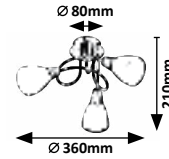

5534

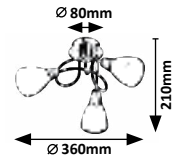

POLLA



6078

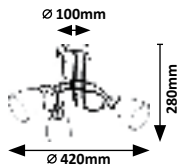

6079

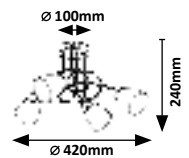

5532 **MG**

☒ E14 / 3x max. 40W
IP20 • 19627
satin chrome/alabaster



5533 **MG**

☒ E14 / 3x max. 40W
IP20 • 19627
antique bronze/alabaster



5534 **MG**

☒ E14 / 3x max. 40W
IP20 • 19627
chrome/alabaster



6078 **MG**

☒ E14 / 3x max. 40W
IP20 • 19243
satin chrome/white



6079 **MG**

☒ E14 / 4x max. 40W
IP20 • 19243
satin chrome/white



CONNOR



AMY

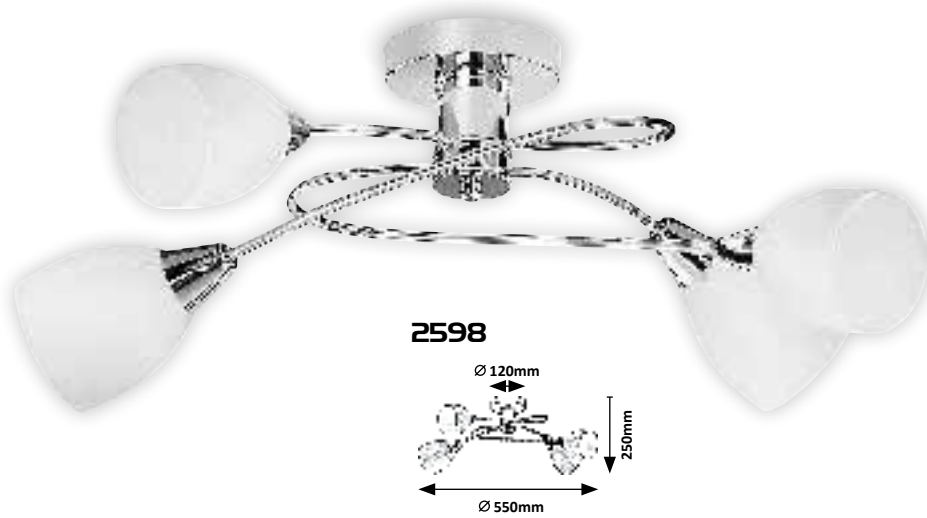

2598 **MG**

☒ E14 / 4x max. 60W
IP20 • 19252
chrome/white



5690 **MG**

☒ E14 / 3x max. 40W
IP20 • 19654
satin chrome/opal glass



5691 **MG**

☒ E14 / 5x max. 40W
IP20 • 19654
satin chrome/opal glass





5975

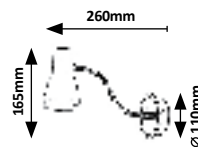

5976

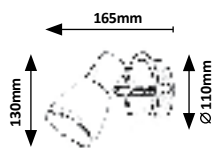

5977

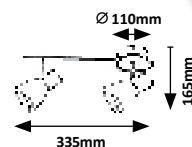

5978

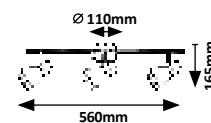

5979



5975 **MG**

☒ E14 / 1x max. 15W
IP20 •
 19498
black/chrome/white



S 36R25C 353715

5976 **MG**

☒ E14 / 1x max. 15W
IP20 •
 19498
black/chrome/white



S 36R25C 353712

5977 **MG**

☒ E14 / 2x max. 40W
IP20 • 19498
black/chrome/white



S 36R25C 353710

5978 **MG**

☒ E14 / 3x max. 40W
IP20 • 19498
black/chrome/white



S 36R25C 353708

5979 **MG**

☒ E14 / 4x max. 40W
IP20 • 19498
black/chrome/white



S 36R25C 353703

HARMONY LUX

Others / Best match

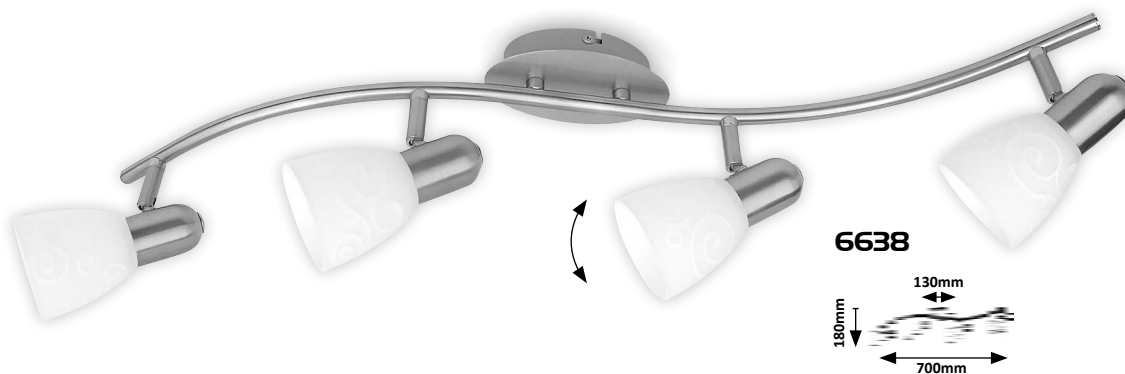
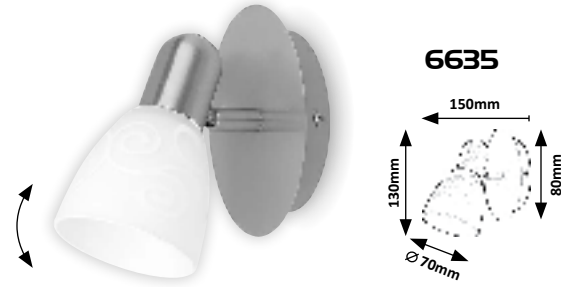

6635 MG

☒ E14 / 1x max. 40W
IP20 • 19065
satin chrome/white



S 392250 360317

6636 MG

☒ E14 / 2x max. 40W
IP20 • 19065
satin chrome/white



S 392250 360304

6637 MG

☒ E14 / 3x max. 40W
IP20 • 19065
satin chrome/white



S 392250 360311

6638 MG

☒ E14 / 4x max. 40W
IP20 • 19065
satin chrome/white



S 392250 360328

ELITE

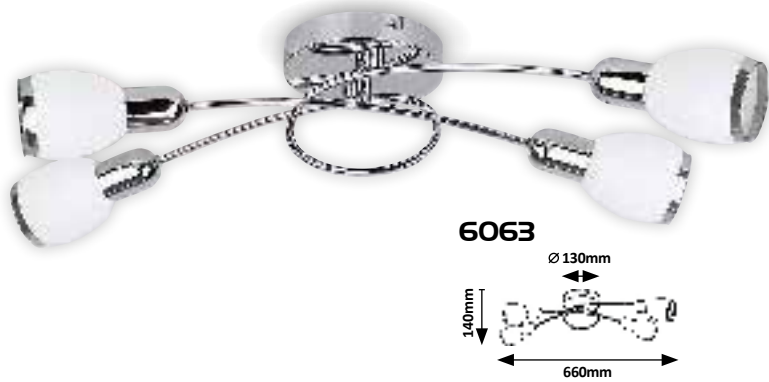
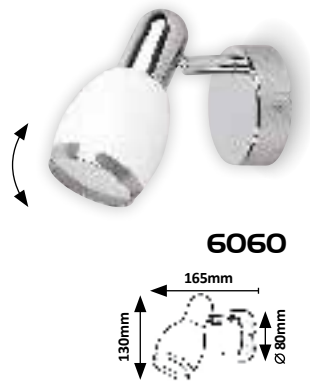

6060 **MG**

☒ E14 / 1x max. 40W
IP20 • 19196
chrome/white



6061 **MG**

☒ E14 / 2x max. 40W
IP20 • 19196
chrome/white



6062 **MG**

☒ E14 / 3x max. 40W
IP20 • 19196
chrome/white



6063 **MG**

☒ E14 / 4x max. 40W
IP20 • 19196
chrome/white



ELITE

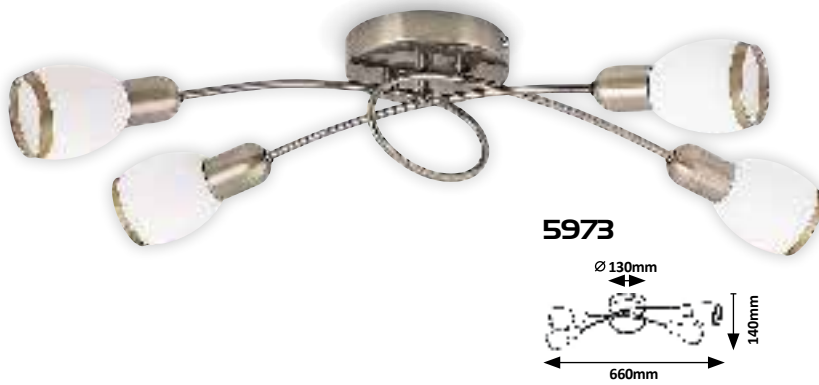
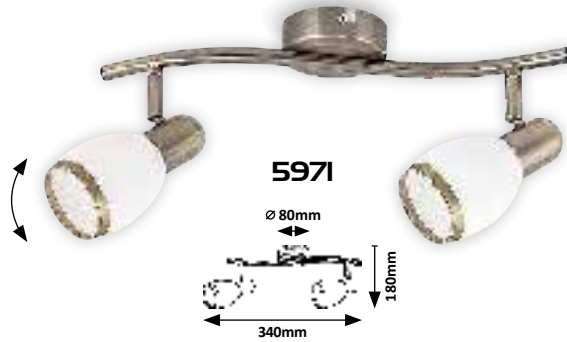

6060



5970



5970 **MG**

☒ E14 / 1x max. 40W
IP20 • 19497
bronze/white



5971 **MG**

☒ E14 / 2x max. 40W
IP20 • 19497
bronze/white



5972 **MG**

☒ E14 / 3x max. 40W
IP20 • 19497
bronze/white



5973 **MG**

☒ E14 / 4x max. 40W
IP20 • 19497
bronze/white



SOMA



6301

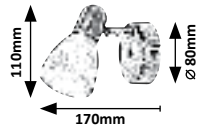

6302

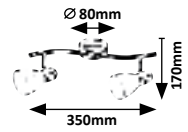

6300

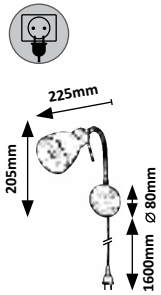

6305

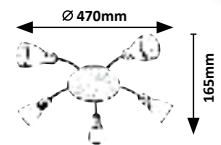

6303

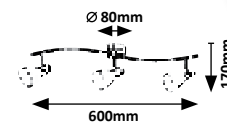

6304

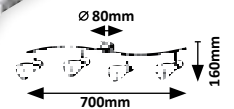

6300 **M G**

☒ E14 / 1x max. 40W
IP20 • □ 9878
□ 9878
satin chrome/white



S 398250 063204

6301 **M G**

☒ E14 / 1x max. 40W
IP20 • □ 9878
satin chrome/white



S 398250 063211

6302 **M G**

☒ E14 / 2x max. 40W
IP20 • □ 9878
satin chrome/white



S 398250 063228

6303 **M G**

☒ E14 / 3x max. 40W
IP20 • □ 9878
satin chrome/white



S 398250 063235

6304 **M G**

☒ E14 / 4x max. 40W
IP20 • □ 9878
satin chrome/white



S 398250 063242

6305 **M G**

☒ E14 / 5x max. 40W
IP20 • □ 9878
satin chrome/white



S 398250 063270

SOMA



6306

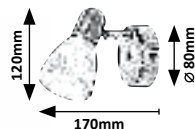

6307

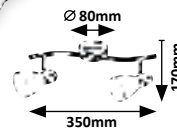

6320

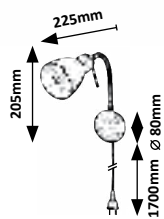

6310

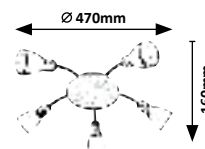

6308

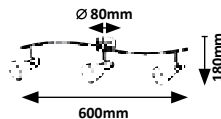

6309

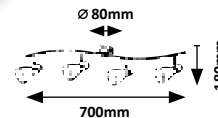

6306 **M G**

☒ E14 / 1x max. 40W
IP20 • 9878
bronze/white



6307 **M G**

☒ E14 / 2x max. 40W
IP20 • 9878
bronze/white



6308 **M G**

☒ E14 / 3x max. 40W
IP20 • 9878
bronze/white



6309 **M G**

☒ E14 / 4x max. 40W
IP20 • 9878
bronze/white



6310 **M G**

☒ E14 / 5x max. 40W
IP20 • 9878
bronze/white



6320 **M G**

☒ E14 / 1x max. 40W
IP20 • 9878
bronze/white





6591

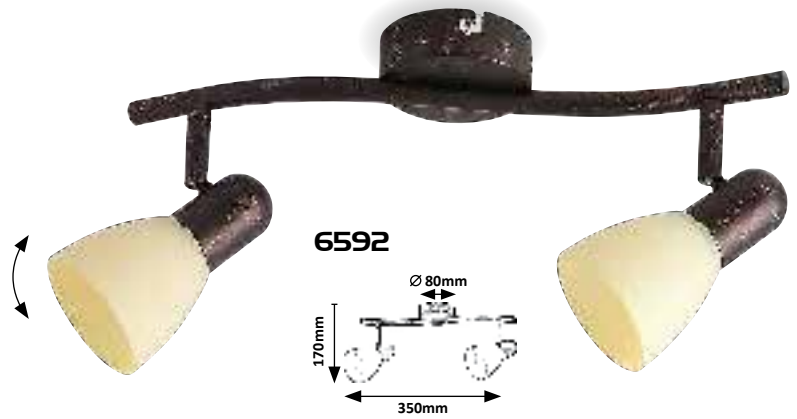

6592



6593



6594

6591 **MG**

☒ E14 / 1x max. 40W
IP20 • 19059
antique brown/cream



5 398296 065310

6592 **MG**

☒ E14 / 2x max. 40W
IP20 • 19059
antique brown/cream



5 398296 065323

6593 **MG**

☒ E14 / 3x max. 40W
IP20 • 19059
antique brown/cream



5 398296 065330

6594 **MG**

☒ E14 / 4x max. 40W
IP20 • 19059
antique brown/cream



5 398296 065347

ART FLOWER



6356

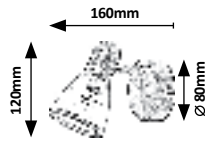

6357

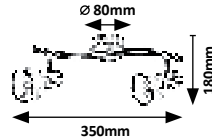

6358

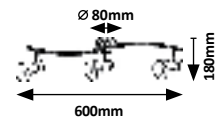

6359

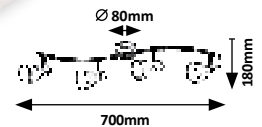

6356 (M) (G)

☒ E14 / 1x max. 40W
IP20 • 1279
white alabaster/bronze



S 398296 06356.1

6357 (M) (G)

☒ E14 / 2x max. 40W
IP20 • 1279
white alabaster/bronze



S 398296 06357.2

6358 (M) (G)

☒ E14 / 3x max. 40W
IP20 • 1279
white alabaster/bronze



S 398296 06358.3

6359 (M) (G)

☒ E14 / 4x max. 40W
IP20 • 1279
white alabaster/bronze



S 398296 06359.4

MARTHA



5014



5015

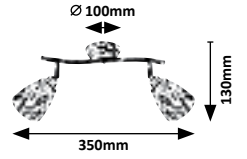

5016

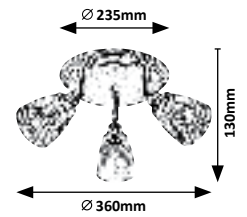

5017

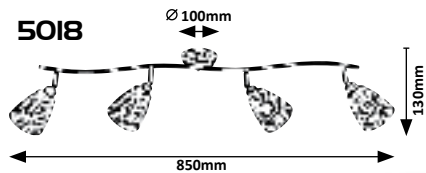
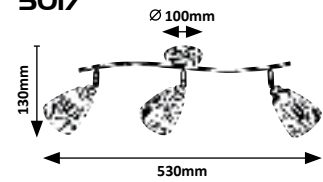

5018



5014 **MG**

☒ E14 / 1x max. 40W
IP20 • • • 19813
antique bronze/transparent



5015 **MG**

☒ E14 / 2x max. 40W
IP20 • • • 19813
antique bronze/transparent



5016 **MG**

☒ E14 / 3x max. 40W
IP20 • • • 19813
antique bronze/transparent



5017 **MG**

☒ E14 / 3x max. 40W
IP20 • • • 19813
antique bronze/transparent



5018 **MG**

☒ E14 / 4x max. 40W
IP20 • • • 19813
antique bronze/transparent

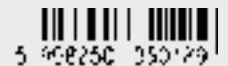

GRANDO



6545

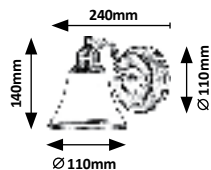

6546

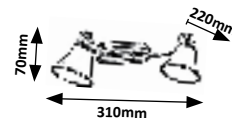

6548

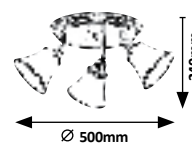

6547

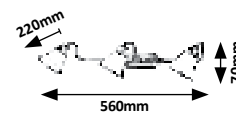

6545 **MG**

☒ E14 / R50 / 1x max. 40W
IP20 • 19161
bronze/white



6546 **MG**

☒ E14 / R50 / 2x max. 40W
IP20 • 19161
bronze/white



6547 **MG**

☒ E14 / R50 / 3x max. 40W
IP20 • 19161
bronze/white



6548 **MG**

☒ E14 / R50 / 3x max. 40W
IP20 • 19161
bronze/white



03

SMART AND LED LIGHTS

OKOS ÉS LED LÁMPÁK

SMART UND LED LEUCHTEN





The colour temperature and luminosity of our lamps can be controlled by a switch, touch switch, remote control or even via our mobile phone. In addition to this, we can use RGB function to create an even cosier atmosphere in our homes. Using the nightlight, memory or even the timer function we can make our everyday more comfortable. Take a look at our smart lamps and lamps with extra features in the next chapter!



Lámpáink színhőmérsékletét és fényerejét kapcsolóval, érintőkapcsolóval, távirányítóval vagy akár saját telefonunkról is vezérelhetjük. Ezek mellett RGB funkcióval varázsolhatjuk hangulatosabbá otthonunkat! Az éjszakai, memória vagy akár az időzítőfunkció segítségével kényelmesebbé tehetjük mindennapjainkat. A következő fejezetben tekintse meg okos és funkciós lámpáinkat!



Die Farbtemperatur und Lichtstärke unserer Lampen kann mittels eines Schalters, Touch-Schalters, einer Fernbedienung oder sogar von unserem Handy kontrolliert werden. Außerdem können wir mithilfe der RGB-Funktion eine gemütliche Atmosphäre in unserem Zuhause schaffen. Mit der Hilfe der Nachtlicht-, Speicher- oder sogar Timerfunktion können wir unsere Alltage bequemer machen. Schauen Sie sich unsere smarte Lampen und Lampen mit Extra-Funktionen im nächsten Kapitel!





Colour temperature

In terms of CCT we differentiate 3 colour temperatures: cold, natural and warm white. This temperature range indicates which shade of white light is being emitted by the luminaire.

Although choosing the colour temperature is completely subjective, each colour temperature may give us a different sensation. That is the reason why a colder, natural light might be suitable when we need a more concentrated light, e.g. during working or learning, while warm white light is recommended for relaxation or resting in the evening.

Szabályozható színhőmérséklet

A CCT kapcsán 3 színhőmérsékletet különböztetünk meg - hideg, természetes és meleg fehéret. Ez a hőmérsékleti skála jelzi, hogy a fehér fény mely tónusát bocsátja ki a lámpatest.

Bár a színhőmérséklet kiválasztása teljesen szubjektív, mégis az egyes színhőmérsékletek más és más érzetet adhatnak. Éppen ezért, ha például egy koncentráltabb fényre van szükségünk pl. munkához vagy tanuláshoz, akkor egy hidegebb, természetes fehér fény lehet a megfelelő, míg lazításhoz, esti pihenéshez a meleg fehér ajánlott.

Farbtemperatur

In Beziehung mit CCT unterscheiden wir 3 Farbtemperaturen: kalt-, neutral- und warmweiß. Dieses Temperaturspektrum gibt an, welcher Ton von weißem Licht vom Beleuchtungskörper abgestrahlt wird.

Obwohl die Auswahl der Farbtemperatur völlig subjektiv ist, können die verschiedenen Farbtemperaturen unterschiedliche Empfindungen bringen. Deshalb kann kälteres, natürliches Licht entsprechend sein, wenn wir ein konzentrierteres Licht benötigen, z. B. beim Arbeiten oder Lernen, während warmweißes Licht zum Relaxieren und zum Rast am Abend empfohlen ist.





RGB

RGB (Red-Green-Blue) lighting means that the respective lamp contains red, green and blue chips. This enables colourful mood-lighting.

Since people are reactive to colours and they are capable of influencing our mood, lamps featuring RGB function are getting preferred in the field of lighting.



RGB

RGB (Red-Green-Blue) világítás alatt azt értjük, hogy az adott lámpa piros, zöld és kék chipkeket tartalmaz. Ezáltal az egyszerre színes hangulatvilágítást biztosíthat.

Mivel az emberek érzékenyek a színekre és ezek képesek befolyásolni a hangulatot is, így a világítás terén is kezdenek előnyt élvezni az RGB funkcióval ellátott lámpák.



RGB

Unter RGB- (Red-Green-Blue) Beleuchtung verstehen wir, daß die jeweilige Lampe rote, grüne und blaue Chips enthält. So kann ein farbiges Stimmungslicht geschafft werden.

Da Menschen empfänglich für Farben sind und diese auch unsere Laune beeinflussen können, werden Lampen mit RGB-Funktion im Bereich von Beleuchtung immer mehr bevorzugt.





Dimmable

Dimmability means changing the luminosity of the lamp. Adjustable lamps help us configure lighting in our environment in a simple and aesthetic way. Regarding the control mode we differentiate two trends depending on whether the luminosity of the lamp can be adjusted gradually or continuously.

Szabályozható fényerő

A dimmelhetőség a lámpa fényerősségének változtatását jelenti. A szabályozható lámpák segítenek, hogy egyszerűen és esztétikusan tudjuk kialakítani a környezetünkben a fényt. A szabályozás módjánál megkülönböztetünk két irányt attól függően, hogy a lámpa fényereje fokozatokban vagy folyamatosan állítható.

Lichtstärke Regler

Dimmbarkeit bedeutet die Änderung der Lichtstärke von der Lampe. Regulierbare Leuchten helfen uns, damit wir die Beleuchtung in unserem Ambiente einfach und ästhetisch gestalten können. Beim Reguliermodus unterscheiden wir zwei Trends abhängig davon, ob die Lichtstärke der Lampe in Stufen oder kontinuierlich reguliert werden kann.



BENEDICK



71015

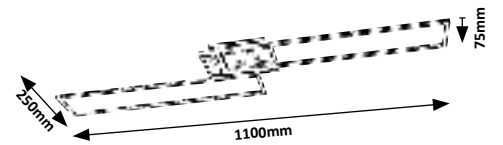

NEFERTUM



71004

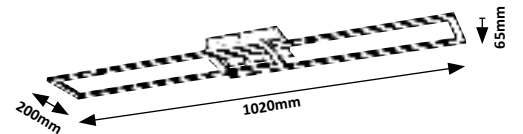

71004 (M) (P)

LED / 38W
(3150lm, 4400lm;
3000K-6500K) incl. • IP20 • 548
black/white



4 746296 710040

71015 (M) (P)

LED / 40W
(3050lm, 4500lm;
2700K-6500K) incl. • IP20 • 561
silver/brushed aluminium/white



4 746296 710150

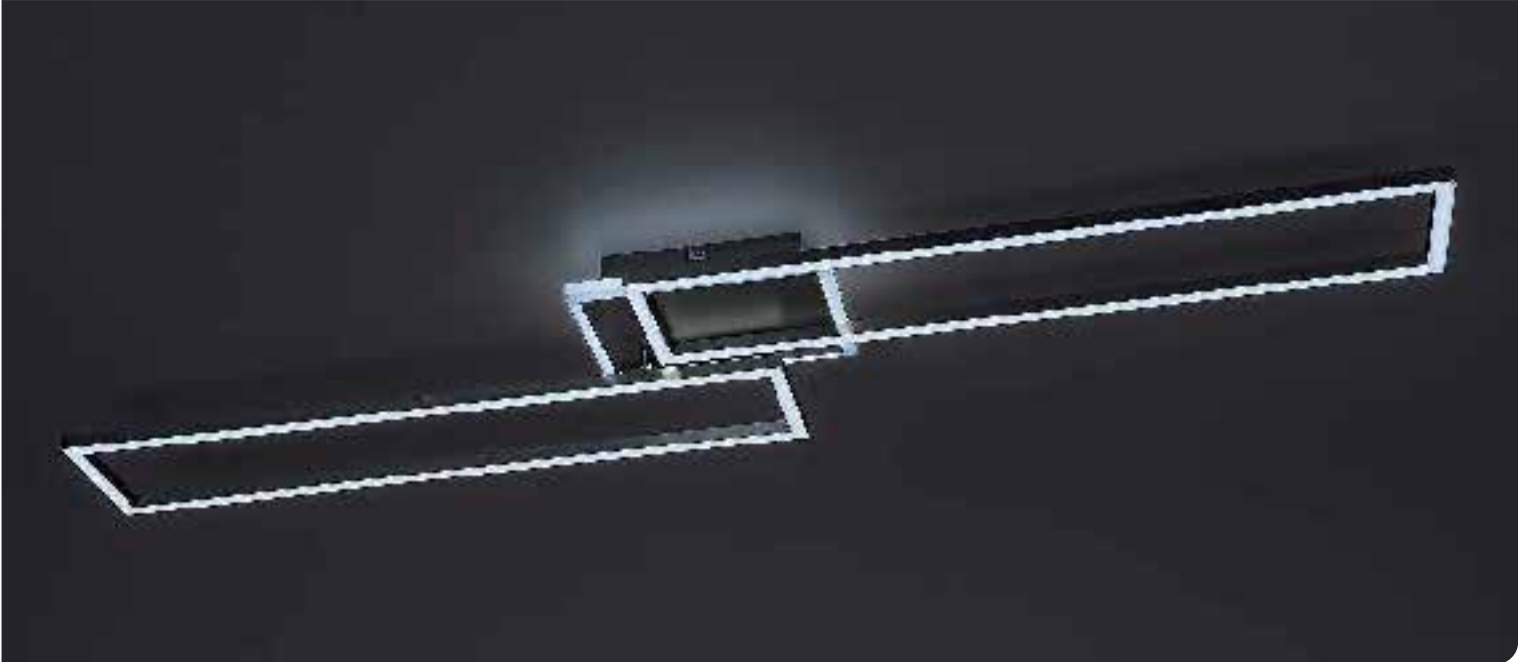
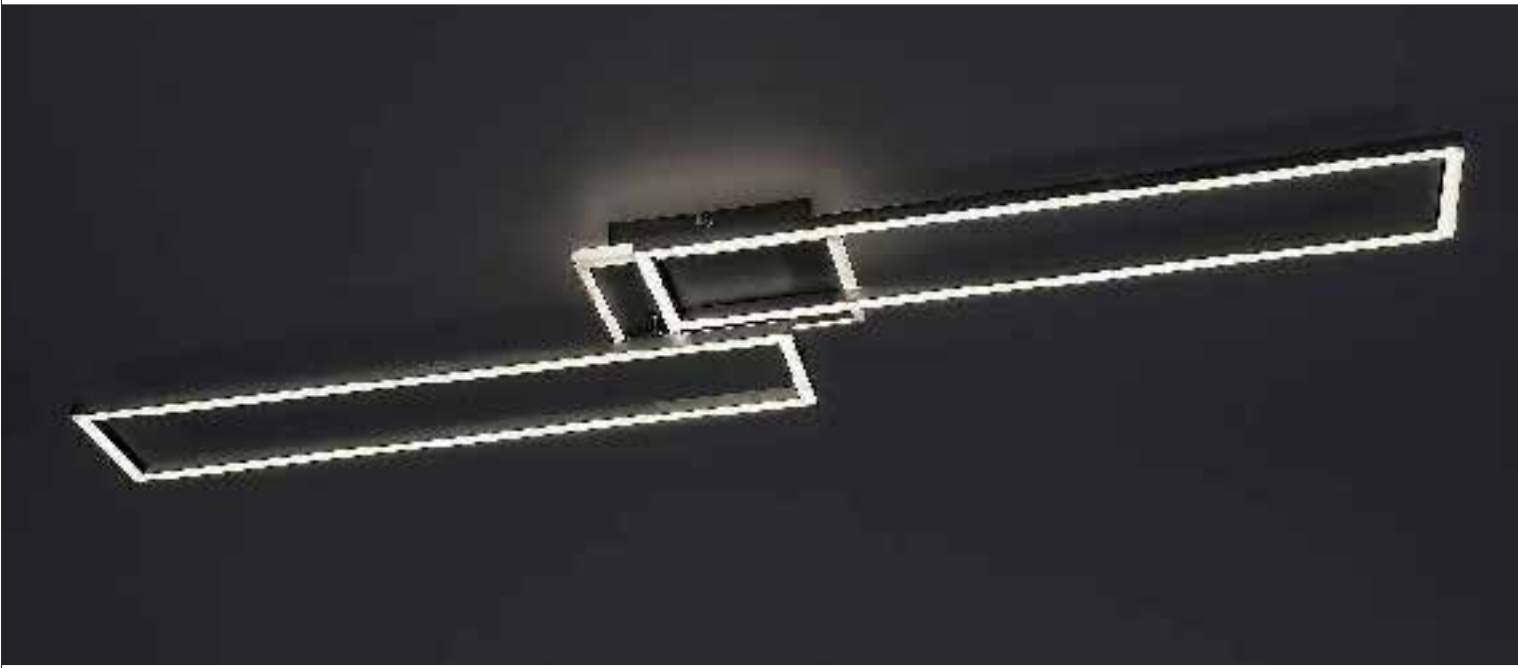

3510

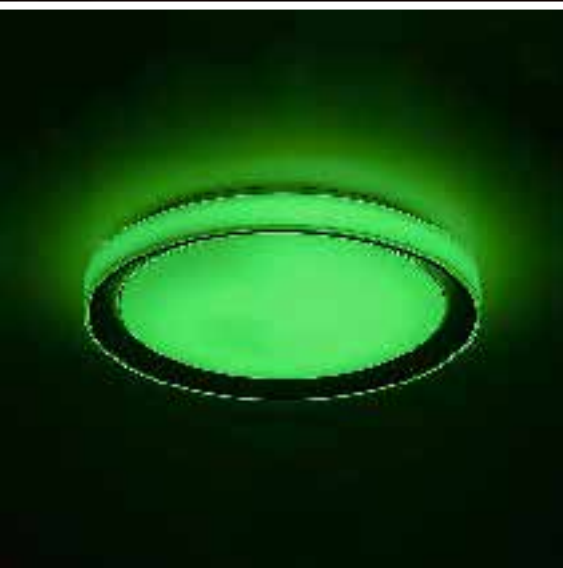

EVEREST



3510

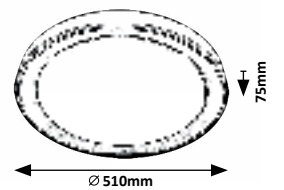

OPHELIA



5364

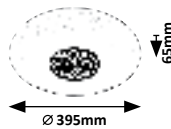

5365

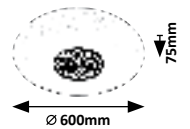

3510 (M) (P)

LED / 40W
(3200lm, 2700K-6500K) incl.
IP20 • 19991 • 563
silver/white

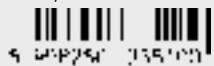

5364 (M) (P)

LED / 24W
(2000lm, 3000K-6500K) incl.
IP20 • 19584 • 563
chrome/white

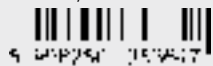

5365 (M) (P)

LED / 40W
(3200lm, 3000K-6500K) incl.
IP20 • 19585 • 563
chrome/white

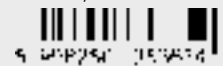

RODION



3509

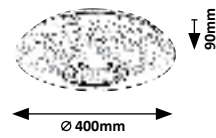

DAMIEN



5540

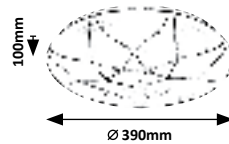

3509



3509 (M A)

LED / 24W
(1800lm, 2700K-6500K) incl.
IP20 • 19770 • 536
white

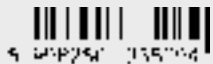

9 242294 350904

5540 (M P)

LED / 24W
(1920lm, 3000K-6500K) incl.
IP20 • 19757 • 522
white



9 392294 554005



71035, 71036



CERRIGEN



71035



∅ 310mm

55mm



71036



∅ 500mm

80mm

71035 (M) (P)

LED / 24W (1950lm, 2250lm; 3000K-6500K) incl.
IP20 • 20018
white



71036 (M) (P)

LED / 48W (3380lm, 4810lm; 3000K-6500K) incl.
IP20 • 20019
white



MURRY



4682

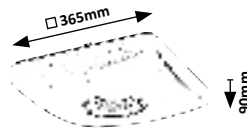

4541

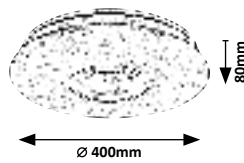

4682



4682 (M) (A)

LED / 18W
(1350lm, 3000K-6000K) incl.
IP20 • 19938 • 545
white

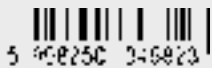

4541 (M) (P)

LED / 24W
(1440lm, 3000K-6000K) incl.
IP20 • 19717 • 535
white





FAUSTINE



71016

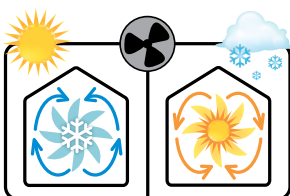
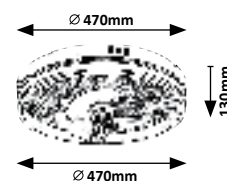

71016

	1x	2x	3x
RPM	670	920	1070
dB	53	56	59

71016 **M P**

LED / 30W (1000lm, 2860lm;
3000K-6500K) incl. • IP20
564 • 15m² • 40W
black/white



HORACIO



71009



71009

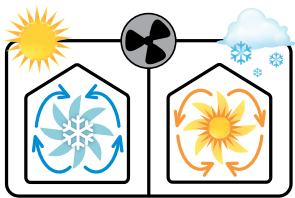
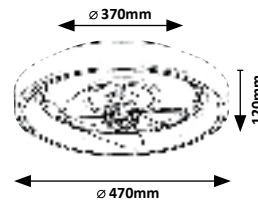

71009 **MA**

LED / 67W (85850lm, 7500lm;
3000K-6000K) incl. • IP20
560 • 6-8m² • 19W
white/black



71009

	1x	2x	3x	4x	5x	6x
	645	665	675	840	920	940
	41,4	42,4	44,2	44,9	46,9	53,7

5419



ADONIAS



5419

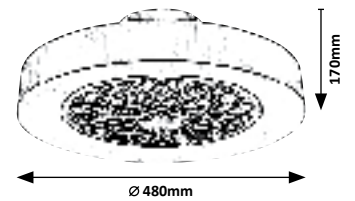

5419, 5420

	1x	2x	3x	4x	5x	6x
RPM	570	660	760	850	950	1050
dB	30	36	42	47	50	52

5419



LED / 35W
 (1600lm, 3000K-6000K) incl.
 IP20 • 565 • 15-20 m² • 15W
 black/white



BENICIO



5420

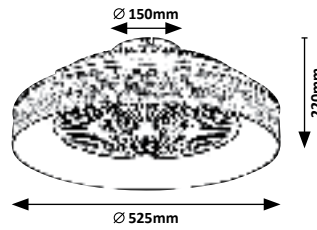

5420

(M) (T)

LED / 35W
 (1050lm, 3000K-6000K) incl.
 IP20 • 565 • 15-20 m² • 15W
 grey/white



5 918253 34200

5419, 5420

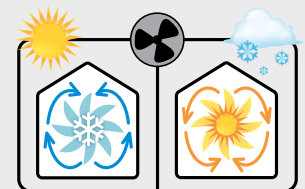

6710, 6857, 6858, 6859

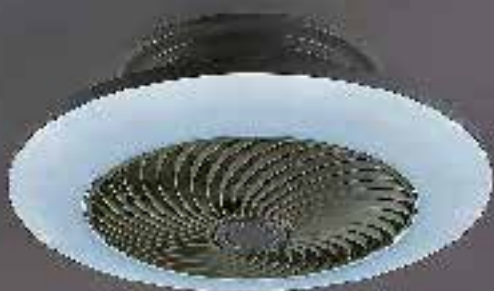

DALFON



6710

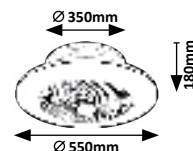

6857

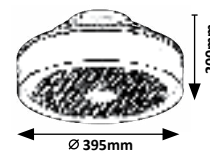

	6710			6857		
	1x	2x	3x	1x	2x	3x
RPM	1050	1190	1320	900	1040	1170
dB	49,4	52,5	55	52	54,7	56

6710 (P A)

LED / 36W
(2100lm, 3000K-6000K) incl.
IP20 • 533 • 8-15m²
white



5 398250 067101

6857 (M A)

LED / 30W
(1500lm, 3000K-6000K) incl.
IP20 • 533 • 8-13m²
grey/transparent



5 398250 068573

DALFON



6858

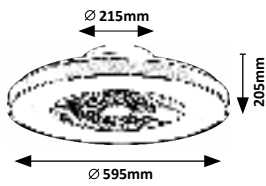

6859

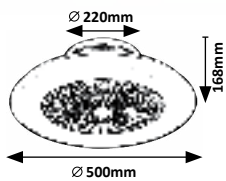

6858 (M) (P)

LED / 40W
(1700lm, 3000K-6500K) incl.
IP20 • Ø 520 • 40m²
white/silver

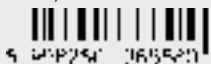

9 509251 163521

6859 (M) (P)

LED / 30W
(1700lm, 3000K-6500K) incl.
IP20 • Ø 520 • 30m²
white/silver

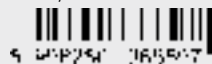

9 509251 163527

	6858			6859		
	1x	2x	3x	1x	2x	3x
RPM	670	920	1070	670	920	1070
dB	46,9	52,6	54,7	47,4	54,2	56,7

3254



TORNADO



3254

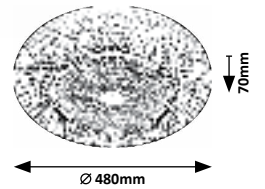

LUPITA



2130

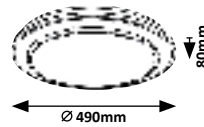

2131

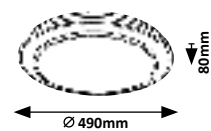

3254 (M) (P)

LED / 72W
(5470lm, 3000K-6500K) incl.
IP20 • 19986 • 539
chrome/white



2130 (M) (P)

LED / 40W
(2700lm, 3000K-6500K) incl.
IP20 • 19958 • 539
black/white



2131 (M) (P)

LED / 40W
(2700lm, 3000K-6500K) incl.
IP20 • 19959 • 539
silver/white



TANELI



6958

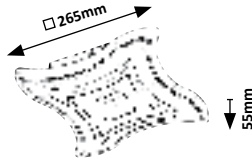

6959

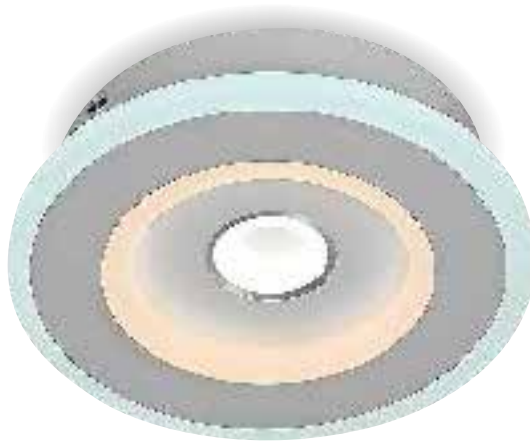
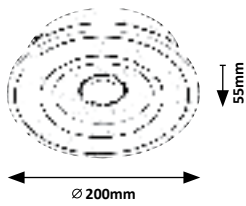

6960

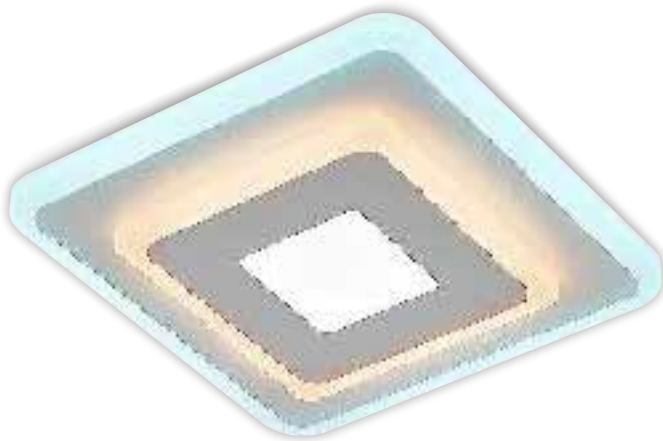
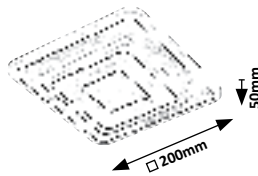

6958



6958 (M) (A)

LED / 20W
(1300lm, 3000K-6000K) incl.
IP20
white/chrome



6959 (M) (A)

LED / 20W
(1300lm, 3000K-6000K) incl.
IP20
white/chrome



6960 (M) (A)

LED / 12W
(880lm, 3000K-6000K) incl.
IP20
white



3264



TANELI

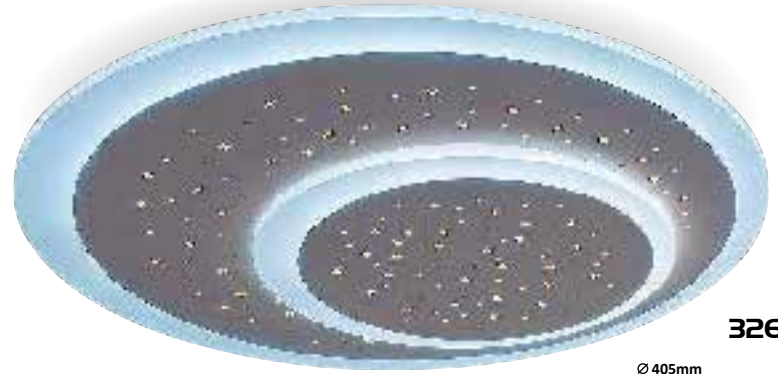

3264

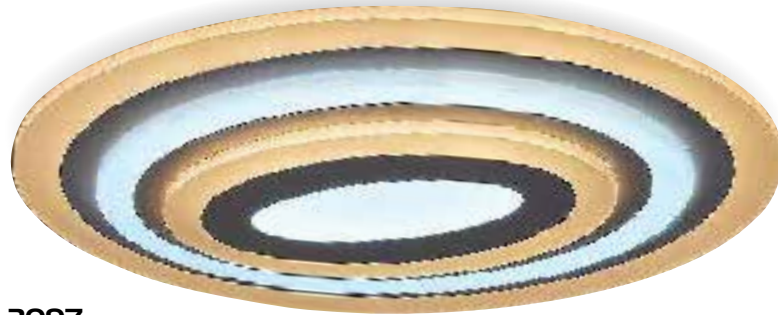
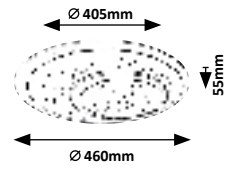

3097

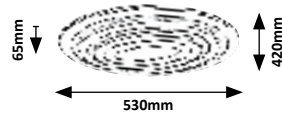

3098

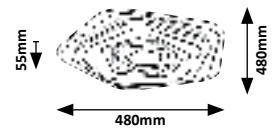

3097 (M) (A)

LED / 41W
(3053lm, 3000K-6500K) incl.
IP20 • 528
white



5 362256 330270

3098 (M) (A)

LED / 54W
(4101lm, 3000K-6500K) incl.
IP20 • 528
white



5 362256 330283

3264 (M) (A)

LED / 47W
(2440lm, 3000K-6000K) incl.
IP20 • 528
white



5 362256 332642

TANELI



3099

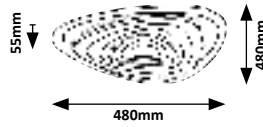

3100

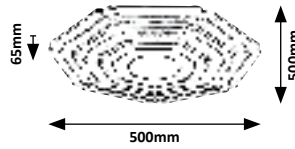

3099 (MA)

LED / 51W
 (3685lm, 3000K-6500K) incl.
 IP20 • 528
 white



5 362250 330760

3100 (MA)

LED / 41W
 (3046lm, 3000K-6500K) incl.
 IP20 • 528
 white



5 362250 330703

3100





PRUE



7110

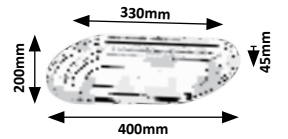

GREMIN



7111

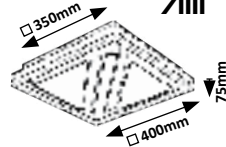

7112

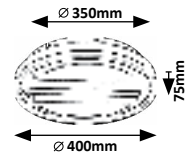

7110 (MP)

LED / 40W
 (2460lm, 4200lm;
 3000K+6000K) incl. • IP20
 white



7111 (MP)

LED / 73W (3750lm, 8400lm;
 3000K+6000K) incl.
 IP20 • 549
 white



7112 (MP)

LED / 55W (2750lm, 7000lm;
 3000K+6000K) incl.
 IP20 • 549
 white



BITSI

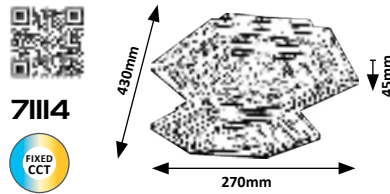
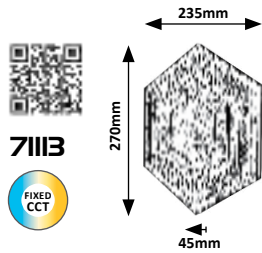

71115



71115

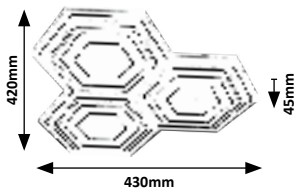

71113 (M) (P)

LED / 23W
 (☼1000lm, ☼2200lm;
 3000K+6000K) incl. • IP20
 black/white



71114 (M) (P)

LED / 44W
 (☼1600lm, ☼4600lm;
 3000K+6000K) incl. • IP20
 black/white



71115 (M) (P)

LED / 72W (☼3200lm, ☼9100lm;
 3000K+6000K) incl.
 IP20 • 549
 black/white



MONTELLE



5859

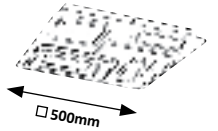

DELION



6250

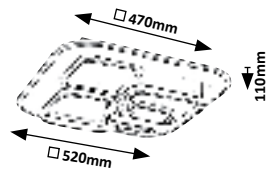

5859 (M) (P)

LED / 56W
(2393lm, 2700K-5500K) incl.
IP20 • 513
matte white



5 392254 358596

6250 (M) (A)

LED / 50W
(3080lm, 3000K-6000K) incl.
IP20 • 523
white/brown



5 392254 362502

CELINDA



5230

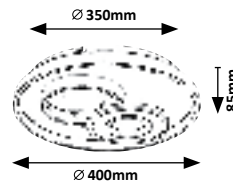

PORTIA



3318

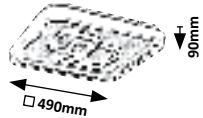

3319

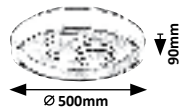

5230 (M P)

LED / 40W
(2000lm, 4000K) incl.
IP20
chrome/white



5 458253 372305

3318 (M P)

LED / 50W
(2200lm, 4000K) incl.
IP20
silver/white/brown

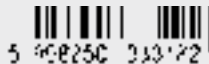

5 458253 333722

3319 (M P)

LED / 40W
(1780lm, 4000K) incl.
IP20
silver/white/brown

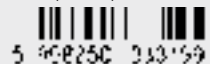

5 458253 333759

71030



NIKOLAUS



New



71030

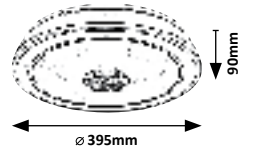

SEDONA



2119

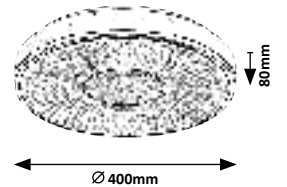

71030 (M) (P)

LED / 24W
(1600lm, 2400lm;
3000K-6500K) incl. • IP20 • 545
black/white



2119 (M) (P)

LED / 24W
(1830lm, 4000K) incl.
IP20 • 19960
black/white/chrome



HECATE



2604

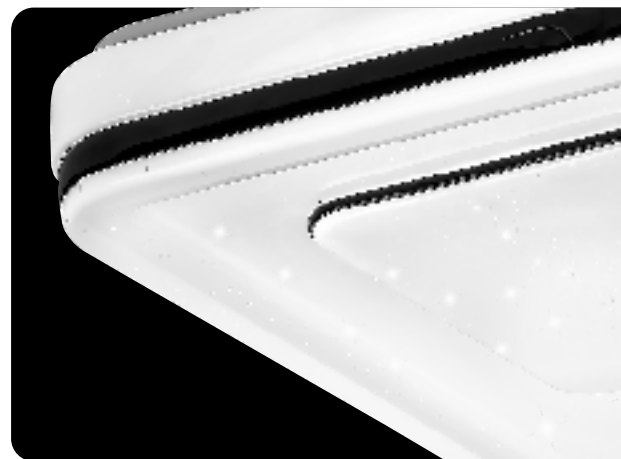
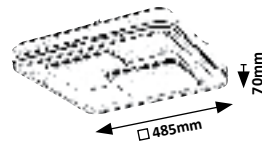

2604 (M) (P)

LED / 40W
(2970lm, 4000K) incl.
IP20 • 19961
black/white





SAPHIRA



3529

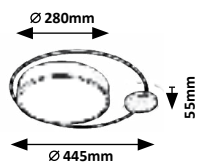

3530

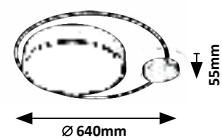

ZENITH



3320

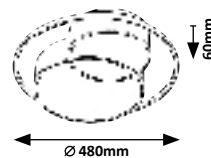

3529 (M) (A)

LED / 28W
(1820lm, 3000K) incl.
IP20 • 19895
black/white

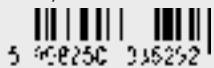

3530 (M) (A)

LED / 48W
(3210lm, 3000K) incl.
IP20 • 19896
black/white

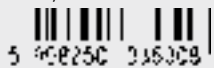

3320 (M) (A)

LED / 40W
(1400lm, 3000K) incl.
IP20
black/white



AQUILA

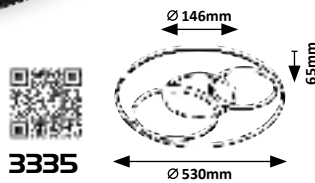

3335

VESTA

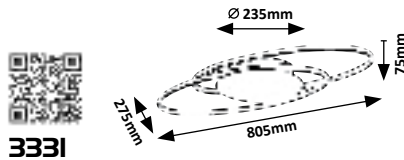
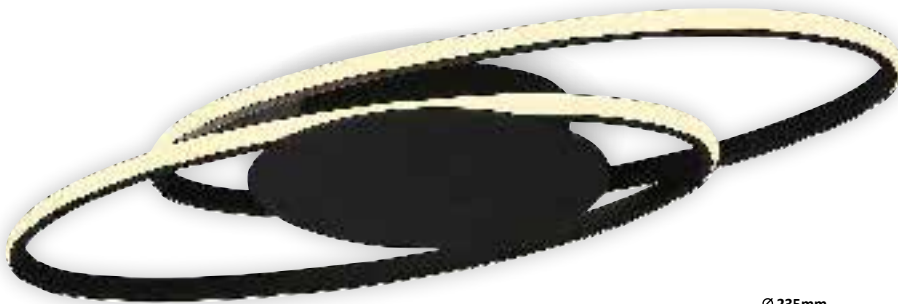

3331

3335



3529, 3530



BACKLIGHT effect

3335 (M) (SI)

LED / 50W
(2300lm, 3000K-6000K) incl.
IP20 • 542
black/white



5 362250 333370

3331 (M) (SI)

LED / 50W
(1900lm, 3000K) incl.
IP20
black/white



5 362250 333371

5285

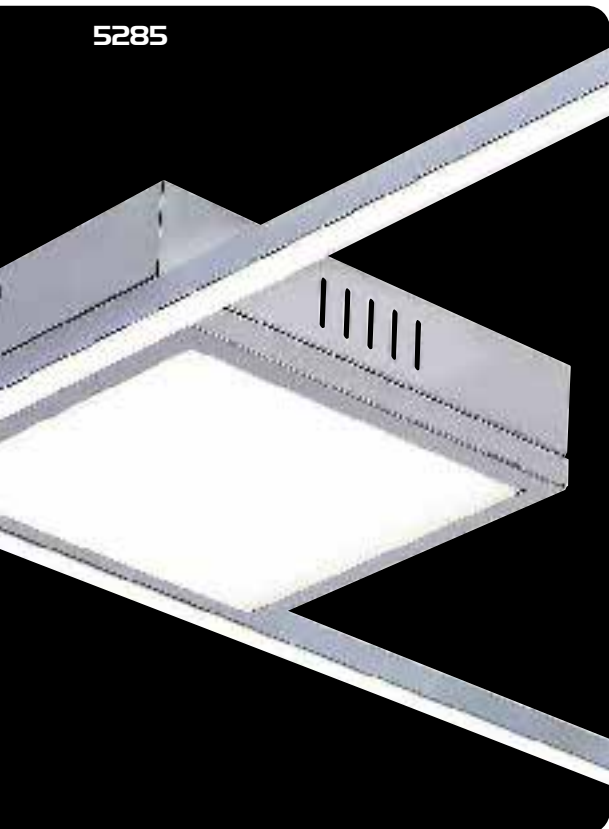

710II



SVETLANA



3513



3514

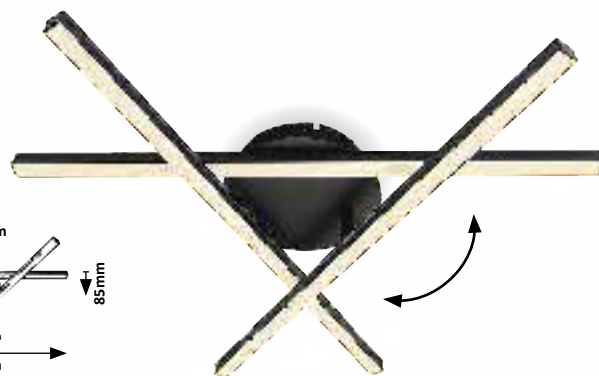
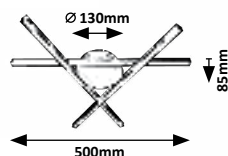

3515

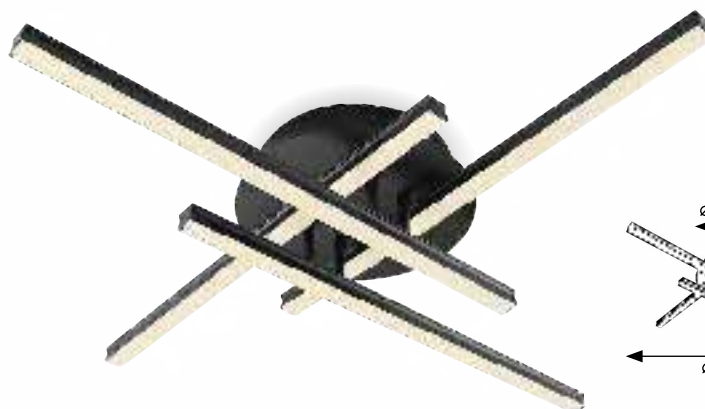
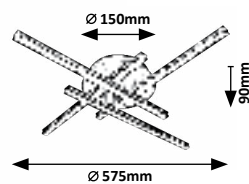

3513 (M) (P)

LED / 16W
(620lm, 3000K) incl.
IP20
matte black/white

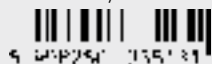

9 249291 135131

3514 (M) (P)

LED / 25W
(950lm, 3000K) incl.
IP20
matte black/white

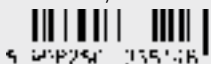

9 249291 135141

3515 (M) (P)

LED / 28W
(1150lm, 3000K) incl.
IP20
matte black/white

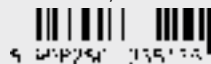

9 249291 135151

SIRIUS

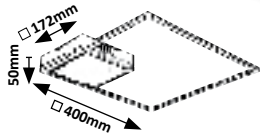
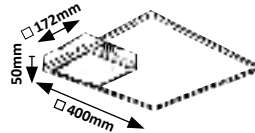

TUMNUS



71010

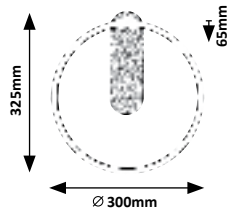

71011

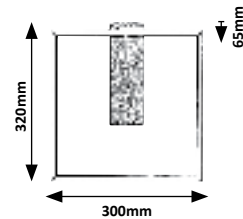

5285 (M) (P)

LED / 30W
(1900lm, 4000K) incl.
IP20
chrome/white



5286 (M) (P)

LED / 30W
(1900lm, 4000K) incl.
IP20
matte black/white



71010 (M) (P)

LED / 14W
(1025lm, 1400lm;
3000K) incl. • IP20
silver/brushed aluminium/white



71011 (M) (P)

LED / 14W
(1060lm, 1500lm;
4000K) incl. • IP20
silver/brushed aluminium/white



THABITA



6867

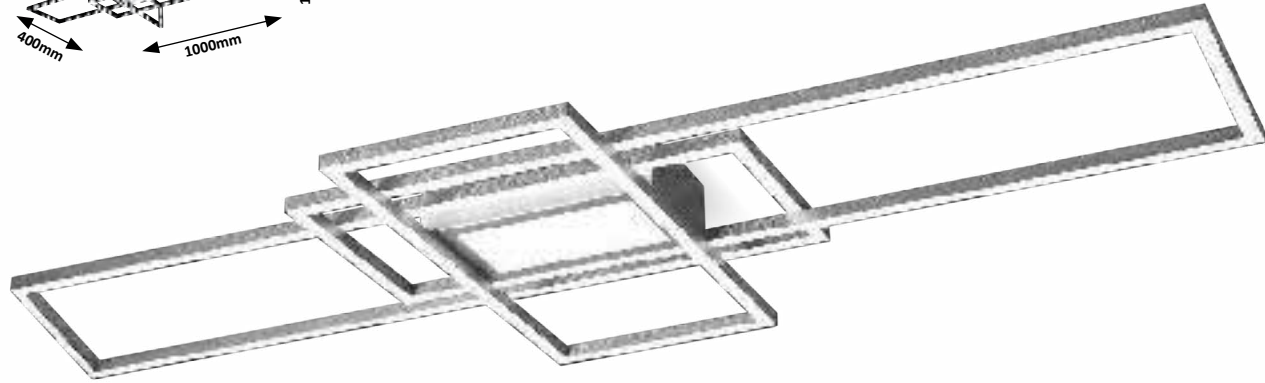
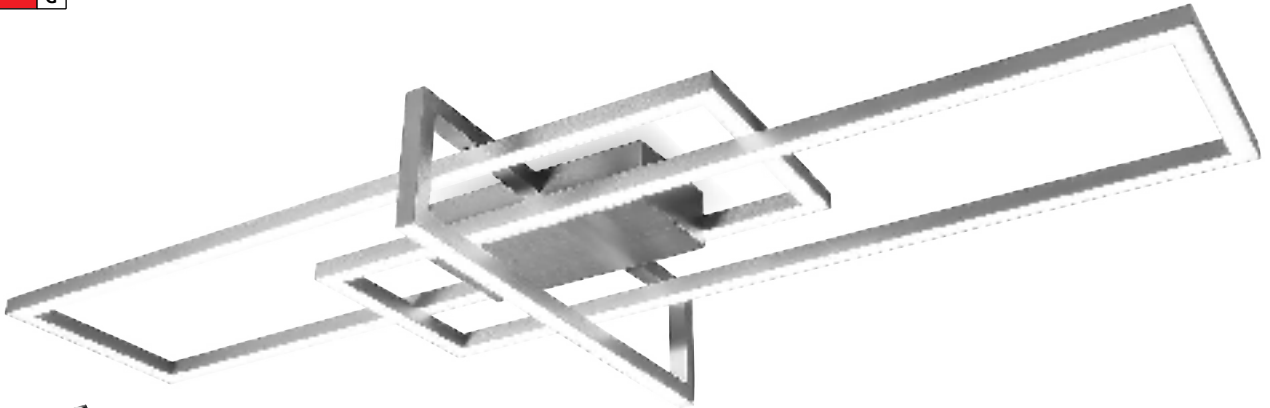
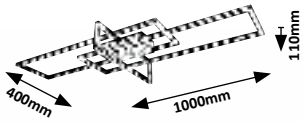

6869

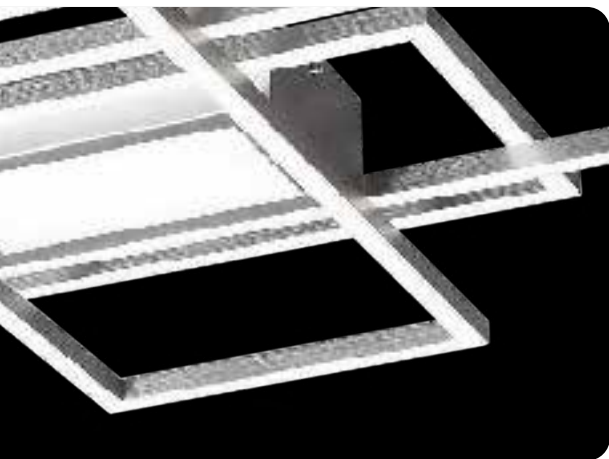
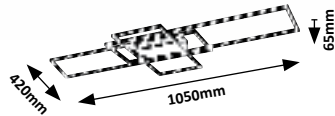

6868

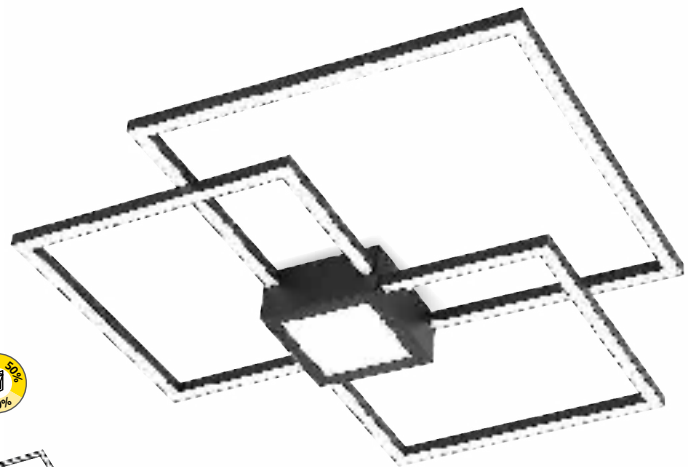
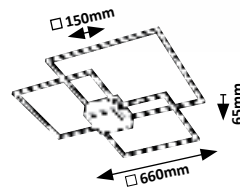

6867 (MP)

LED / 35W
(2500lm, 4000K) incl.
IP20
satin chrome/white



6868 (MP)

LED / 38W
(2250lm, 4000K) incl.
IP20
matte black/white



6869 (MP)

LED / 54W
(4200lm, 3000K-6500K) incl.
IP20 • 566
satin chrome/white



ASHTON



6589

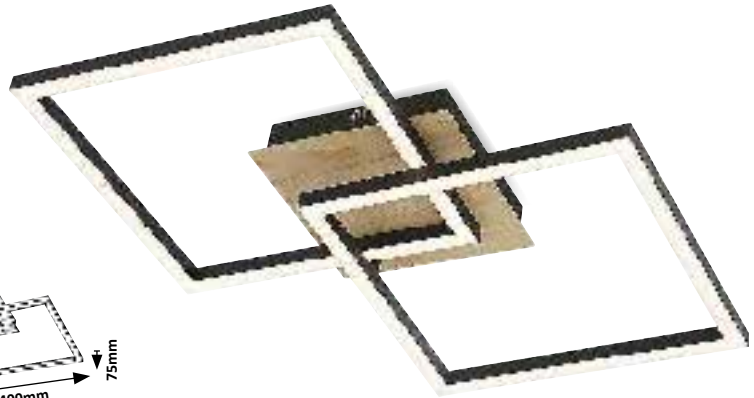
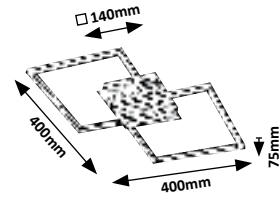

6590

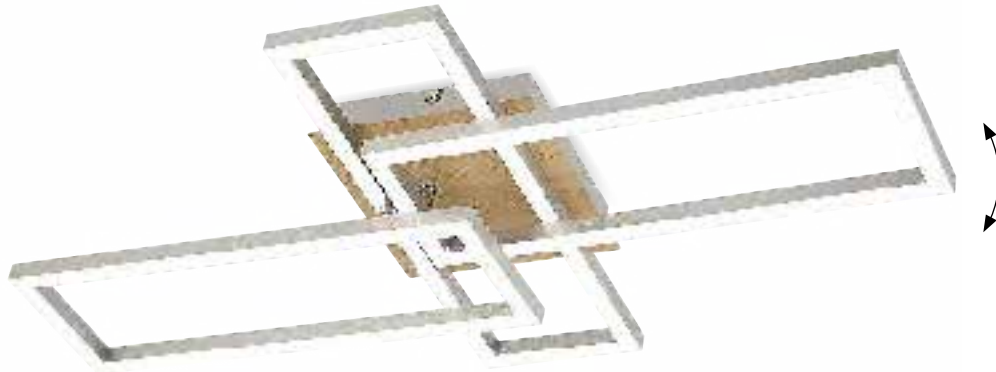
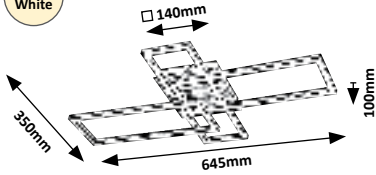

6814

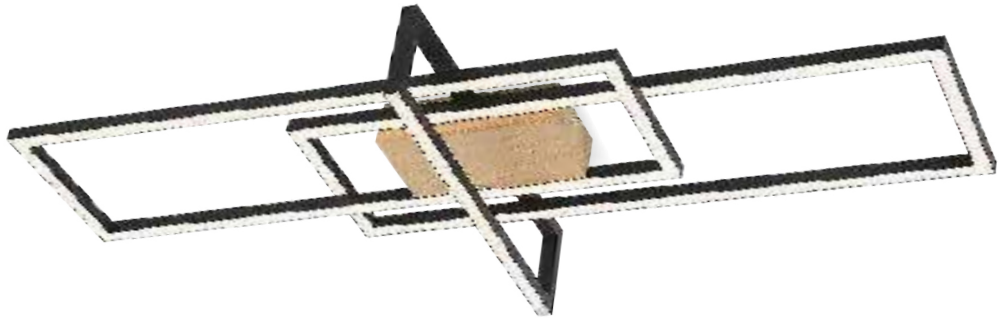
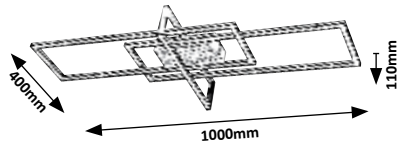

6589 (M) (P)

LED / 24W
(1600lm, 3000K) incl.
IP20
beech/matte black/white



S 392250 265893

6590 (M) (P)

LED / 24W
(1870lm, 4000K) incl.
IP20
beech/satin chrome/white



S 392250 265900

6814 (M) (P)

LED / 35W
(1800lm, 3000K) incl.
IP20
beech/matte black/white



S 392250 265814

DEMETRIUS



7102

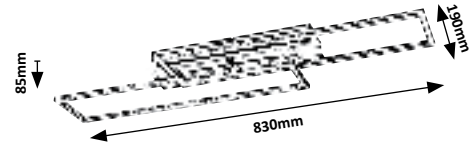

7102



LED / 40W

2850lm, 4400lm;

4000K incl. • IP20

silver/brushed aluminium/white



5 92525 71025

7102

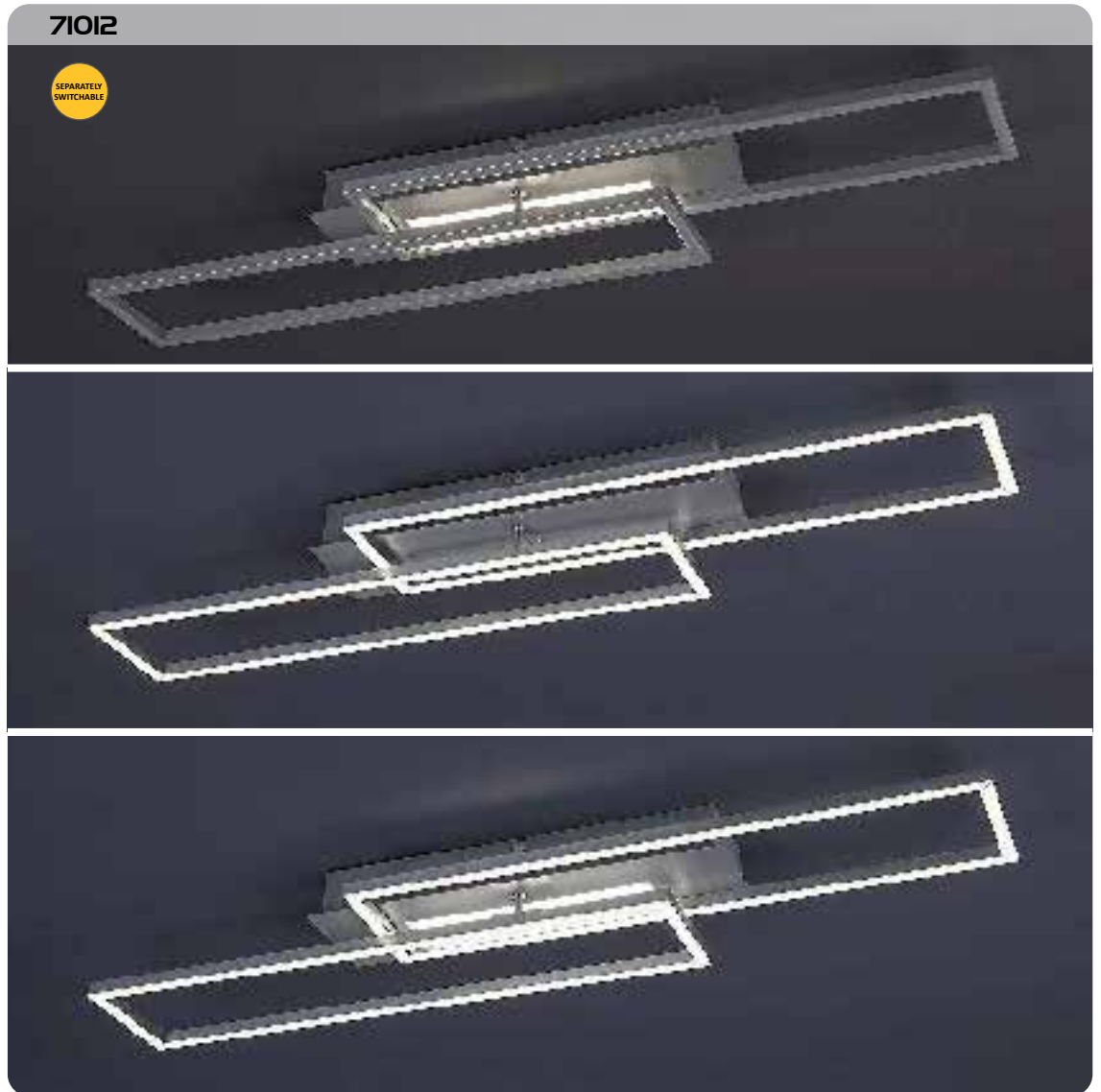

ATHELSTAN

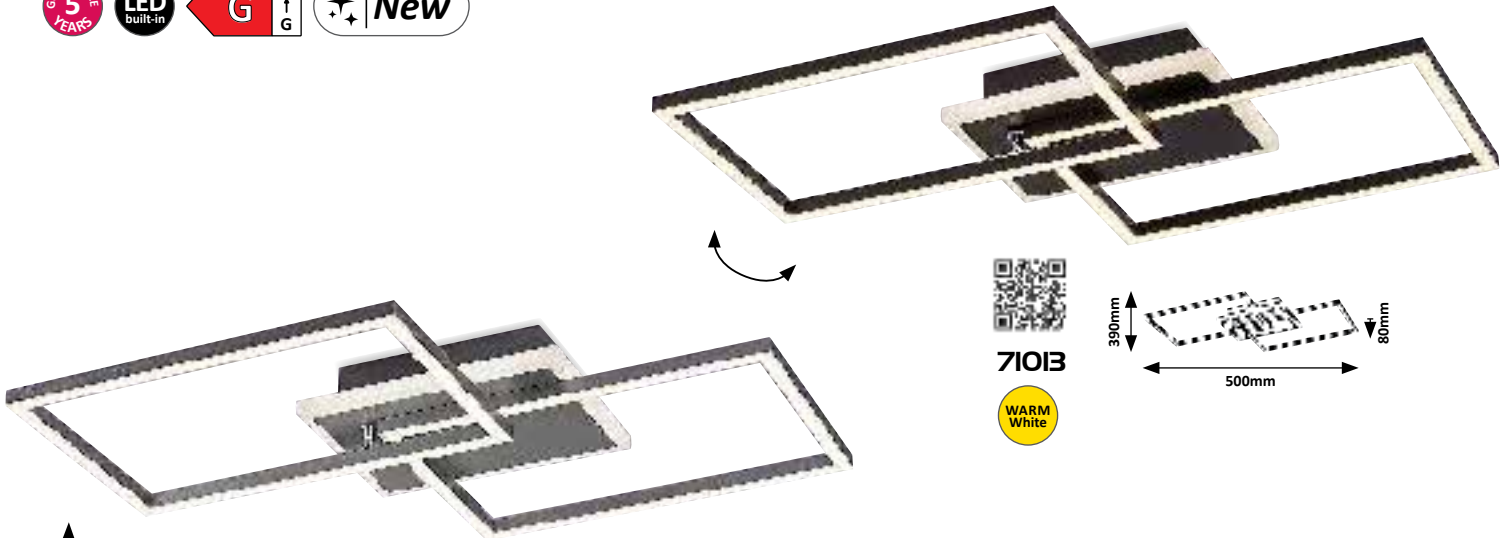

71013

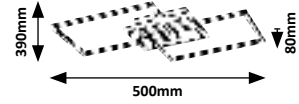

71014

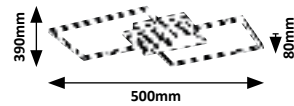

CIRILLA

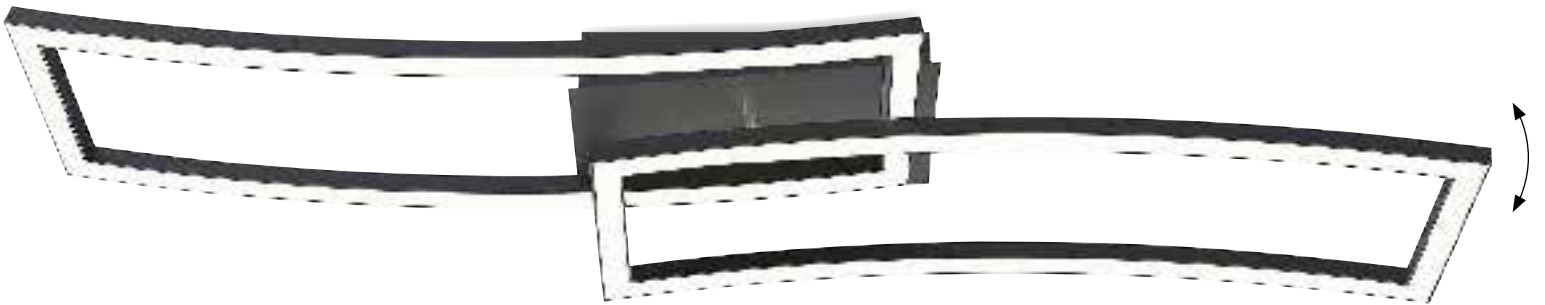

71005

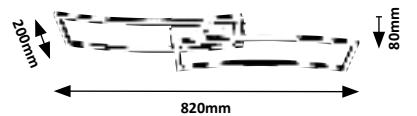

71013 (M) (P)

LED / 40W
 (2050lm, 3300lm;
 3000K) incl. • IP20
 matte black/white



71014 (M) (P)

LED / 40W
 (2900lm, 4300lm;
 4000K) incl. • IP20
 silver/white/brushed aluminium



71005 (M) (P)

LED / 40W
 (3180lm, 4000lm;
 3000K) incl. • IP20
 black/white





ALEXIS



2504

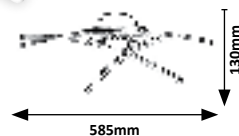

2503

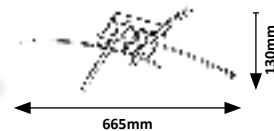

CYCLONE



4606

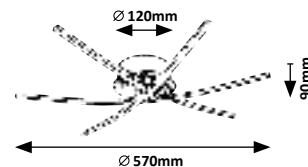

2503 (M) (P)

LED / 24W
(1920lm, 4000K) incl.
IP20
chrome



5 368250 325233

2504 (M) (P)

LED / 21W
(1500lm, 4000K) incl.
IP20
chrome



5 368250 325230

4606 (M) (P)

LED / 21W
(1450lm, 2250lm;
4000K) incl. • IP20
chrome/white



5 038253 346069

NEGAN

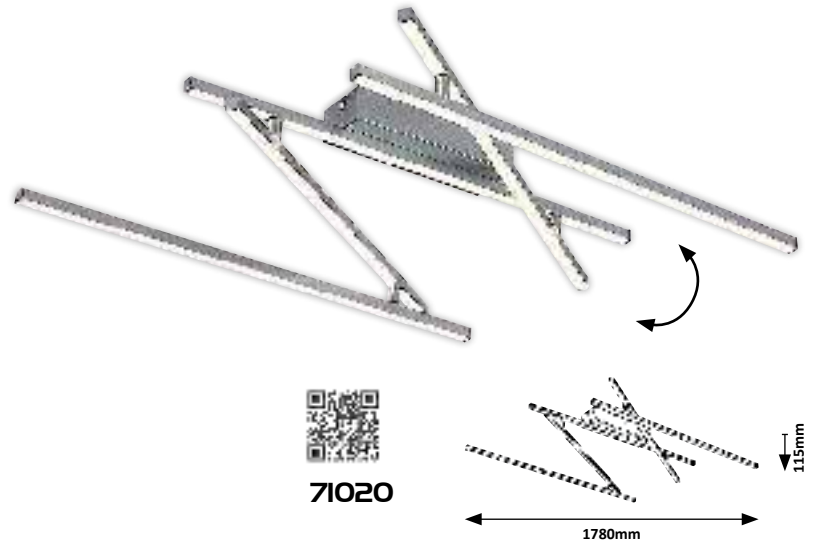
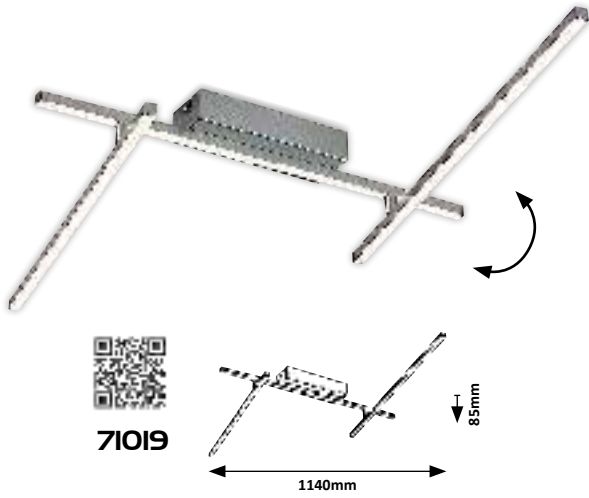

71020

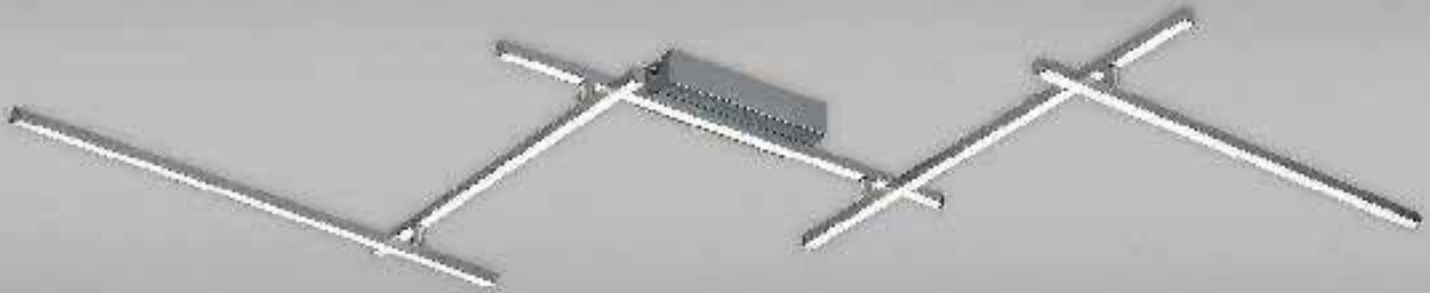

71019 (M P)

LED / 24W
 (1550lm, 2850lm;
 4000K) incl. • IP20
 silver/white



71020 (M P)

LED / 40W
 (2460lm, 4850lm;
 4000K) incl. • IP20
 silver/white



71006, 71007



SOTIRIS



71006

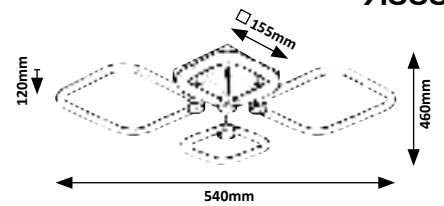

71007

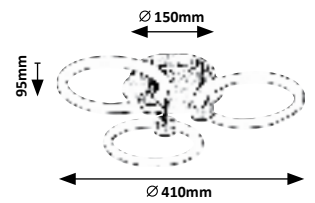

71006 (M) (A)

LED / 47W (4000lm, 7000lm; 3000K, 4000, 6000K) incl. IP20 • 549 matte black/white



71007 (M) (A)

LED / 21W (2300lm, 3500lm; 3000K, 4000, 6000K) incl. IP20 • 549 satin chrome/white



FANDRAL



6996

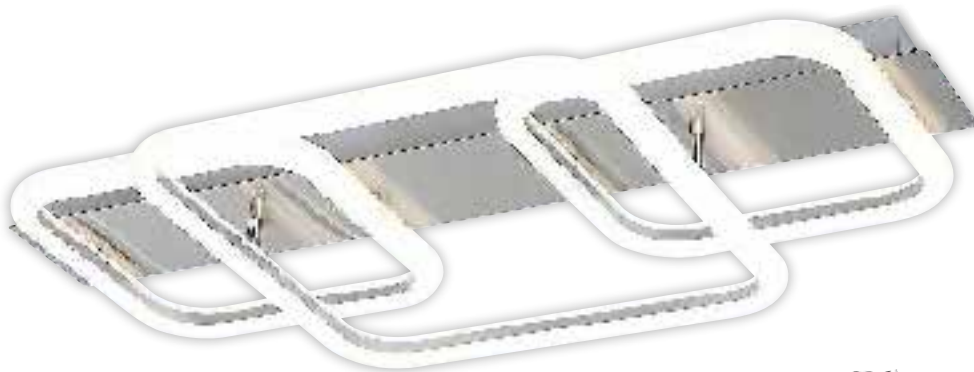
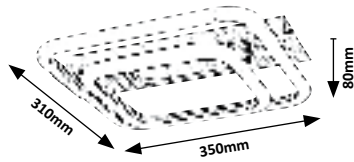

6997

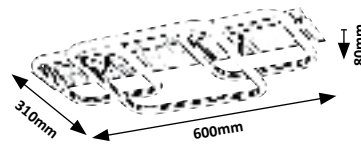

6996 (M) (P)

LED / 33W
(2870lm, 4000K) incl.
IP20
satin chrome/white



5 398290 263370

6997 (M) (P)

LED / 42W
(3800lm, 4000K) incl.
IP20
satin chrome/white



5 398290 263370



2183



SELENA



2183

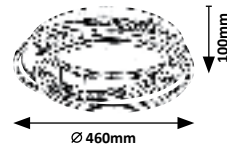

2184

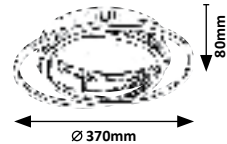

2183



LED / 40W
(3200lm, 4000K) incl.
IP20
chrome



5 398250 121837

2184



LED / 30W
(2400lm, 4000K) incl.
IP20
chrome



5 398250 121844

ZIVA



3064

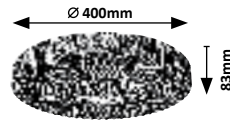

CRESSIDA



2420

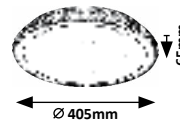

3064 (M) (P)

LED / 36W
(2340lm, 3000K-6000K) incl.
IP20 • 19906 • 534
transparent/chrome

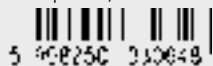

5 908250 30640

2420 (M) (A)

LED / 24W
(1720lm, 4000K) incl.
IP20 • 19966
chrome/white



5 908250 24200



I426, I427



PRIMROSE



I426

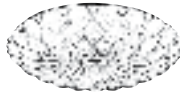

Ø 380mm

I427



Ø 480mm

GALETI



3440



Ø 400mm

I426 (M) (P)

LED / 48W
(2880lm, 3000K-6500K) incl.
IP20 • 19743 • 539
white



5 992250 214200

I427 (M) (P)

LED / 72W
(4320lm, 3000K-6500K) incl.
IP20 • 19744 • 539
white



5 992250 214273

3440 (M) (A)

LED / 24W
(1680lm, 4000K) incl.
IP20 • 19863
silver/white



5 992250 214400

JILLIAN

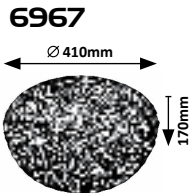
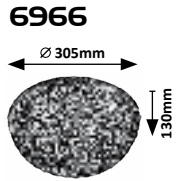

CORALIA

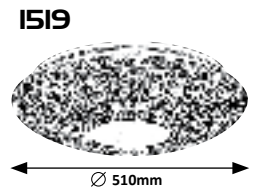
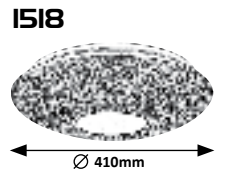

SIREN

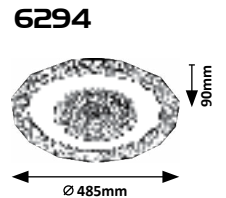

6966 (M) (A)

LED / 18W
(1800lm, 3000K) incl.
IP20 • 19842
tinted colour

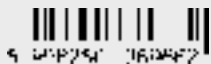

5 362250 369679

6967 (M) (A)

LED / 24W
(2400lm, 3000K) incl.
IP20 • 19843
tinted colour

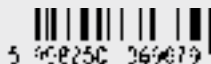

5 362250 369679

1518 (M) (P)

LED / 48W
(3476lm, 3000K-6500K) incl.
IP20 • 19728 • 508
transparent/chrome



5 362250 315128

1519 (M) (P)

LED / 72W
(5728lm, 3000K-6500K) incl.
IP20 • 19729 • 508
transparent/chrome



5 362250 315195

6294 (M) (P)

LED / 50W
(3390lm, 4000K) incl.
IP20 • 19815
white



5 362250 362948

3328, 4634



TAYLA

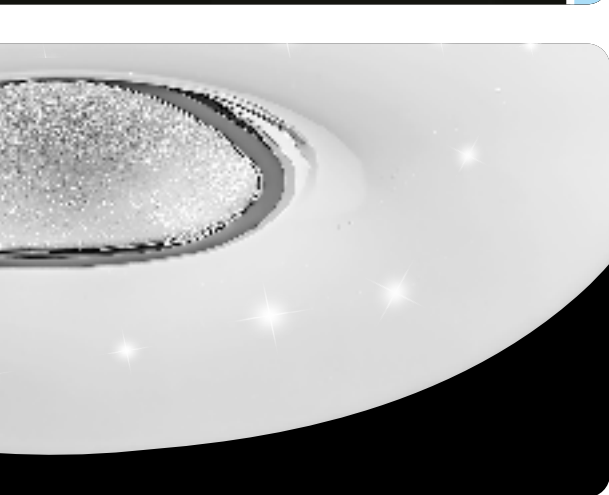

3328

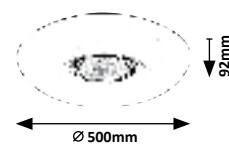

4634

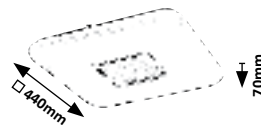

3328 (M) (P)

LED / 60W
(4200lm, 3000K-6500K) incl.
IP20 • 19586 • 524
white



5 392250 332821

4634 (M) (P)

LED / 72W
(6800lm, 3000-6500K) incl.
IP20 • 19939 • 502
white/chrome

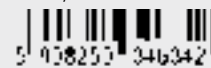

5 038253 346342

CALVIN

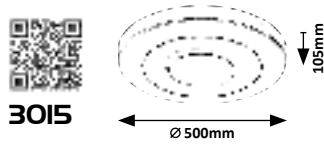

LEONIE

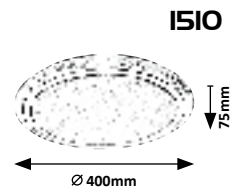

1510



3015 (M) (A)

LED / 40W
(3200lm, 3000K-6000K) incl.
IP20 • 519
white

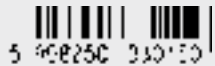

5 902250 301510

1510 (M) (P)

LED / 32W
(2400lm, 3000K-6500K) incl.
IP20 • 19723 • 504
white



5 902250 151002

2117, 2118



NOLAN



1428

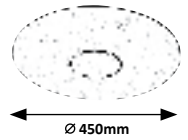

BRUCE



2117

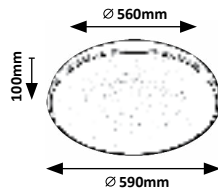

2118

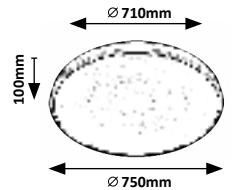

1428 (M) (P)

LED / 72W
(5040lm, 3000K-6500K) incl.
IP20 • 19745 • 508
white/silver



2117 (M) (P)

LED / 40W
(3300lm, 3000-6000K) incl.
IP20 • 19528 • 538
white/chrome



2118 (M) (P)

LED / 60W
(4800lm, 3000-6000K) incl.
IP20 • 19529 • 538
white/chrome



LINDEN



3478

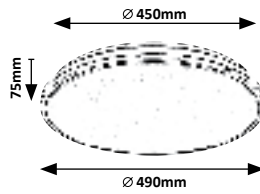

3479

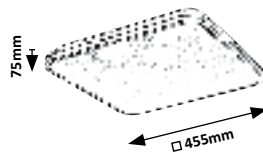

3478, 3479

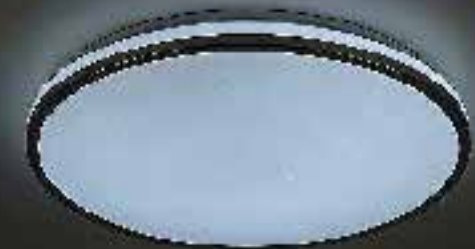

3478 (M) (P)

LED / 50W
(4500lm, 3000-6500K) incl.
IP20 • 19948 • 502
chrome/white



5 038253 34783

3479 (M) (P)

LED / 72W
(5800lm, 3000-6500K) incl.
IP20 • 19949 • 502
chrome/white



5 038253 34793

2249, 3146

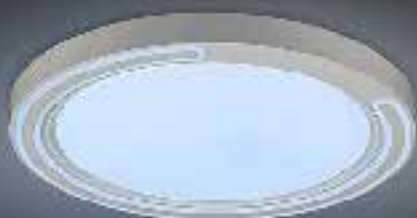

TRITON



2249

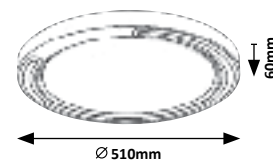

ACHILLES



3146

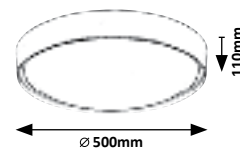

2249 (M) (P)

LED / 40W
(3200lm; 4500lm, 2700K-6500K) incl.
IP20 • 19925 • 563
white



3146 (M) (P)

LED / 40W
(3200lm; 4500lm, 2700K-6500K) incl.
IP20 • 19675 • 563
black/white



RASMUS



New



2290

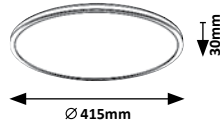

2291

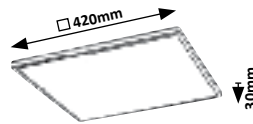

2290, 2291

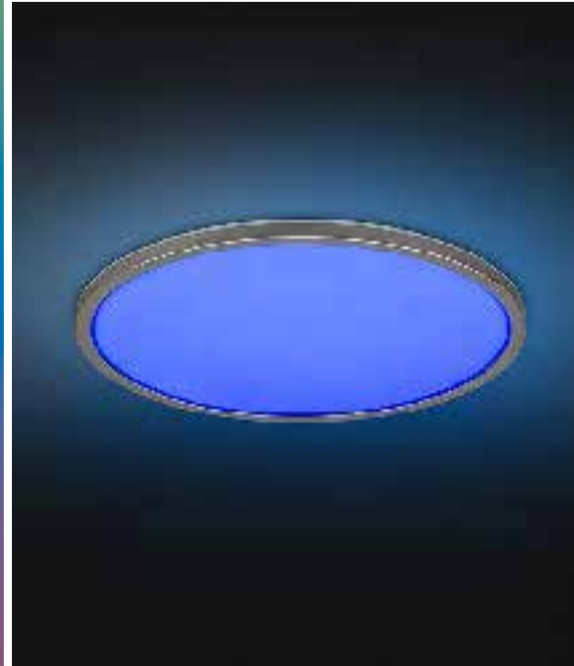

2290

(P)

LED / 22W
 (☰) 2000lm; (☰) 2720lm, 4000K) incl.
 IP20 • 544
 silver/white



2291

(P)

LED / 22W
 (☰) 2100lm; (☰) 2850lm, 4000K) incl.
 IP20 • 544
 silver/white





AZTEC



6905

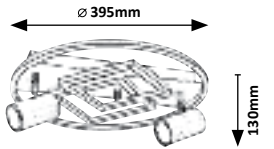

MALCOLM



5366

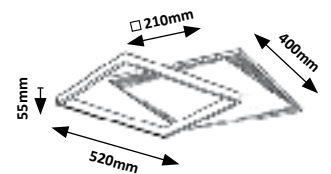

5366 (M) (P)

LED / 35W
 (E) 2150lm; (E) 2500lm, 4000K) incl.
 IP20
 black/white



6905 (M) (P)

LED / 40W
 (E) 2000lm; (E) 3350lm, 4000K) incl.
 IP20
 matte black/white



STREGOBOR



2937

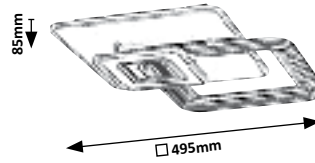

HERKULES



2932

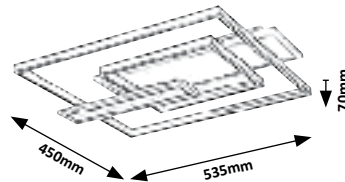

2937

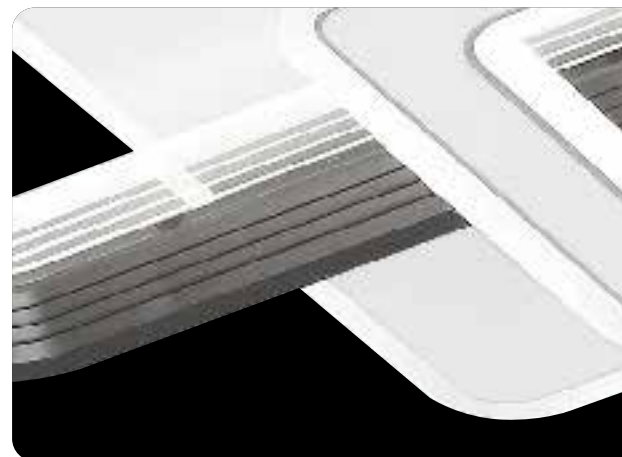

2932 (M) (P)

LED / 50W
 (E) 2700lm; (E) 6430lm, 4000K) incl.
 IP20
 black/white



9 448257 734921

2937 (M) (A)

LED / 48W
 (E) 2950lm; (E) 5170lm, 3000K, 4000K, 6000K) incl.
 IP20 • 523
 grey/white/chrome



9 448257 734976

CASIMIR

5 YEARS GUARANTEE

LED built-in

NATURAL White

G A ↑ G

New

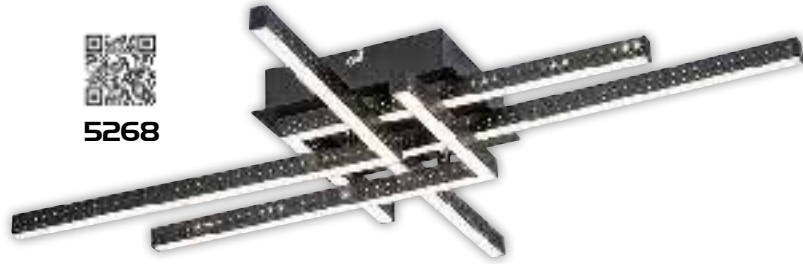

5268

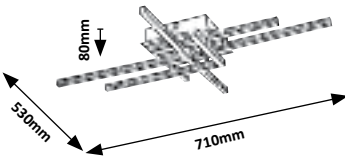

5267

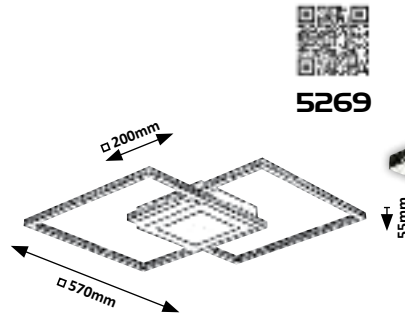
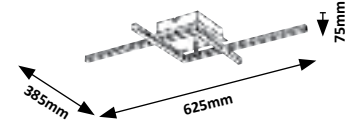

5269

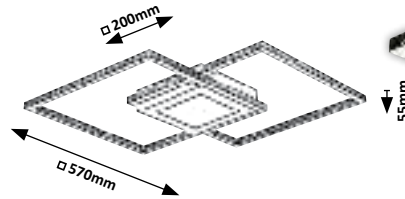

OCEAN

5 YEARS GUARANTEE

LED built-in

NATURAL White

G A ↑ G

New

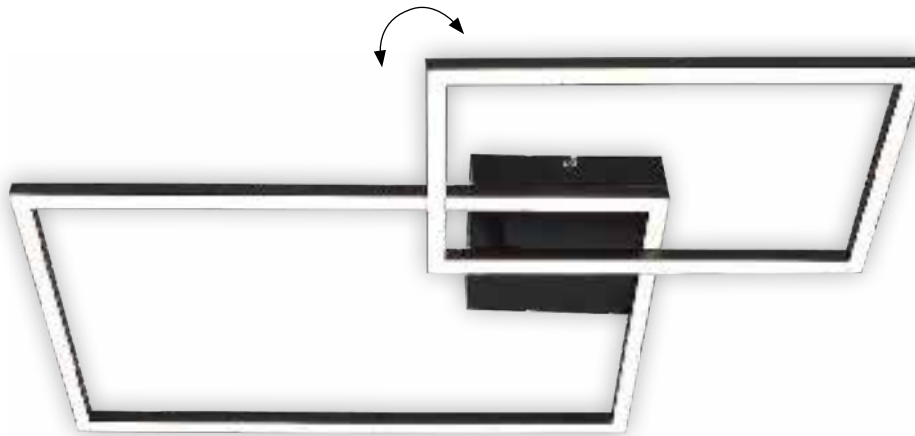

5256

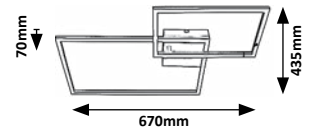

5267 (M) (P)

LED / 23W
 (E) 1250lm; (E) 1800lm, 4000K incl.
 IP20
 matte black/white



5268 (M) (P)

LED / 35W
 (E) 1970lm; (E) 3050lm, 4000K incl.
 IP20
 matte black/white



5269 (M) (P)

LED / 40W
 (E) 2000lm; (E) 3050lm, 4000K incl.
 IP20
 matte black/white



5256 (M) (P)

LED / 26W
 (E) 1700lm; (E) 3350lm, 4000K incl.
 IP20
 matte black/white



HEIMDALL



2280

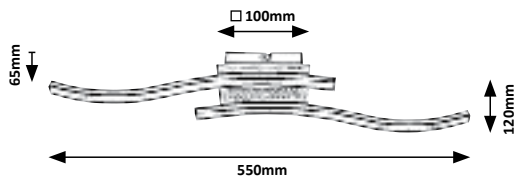

2281

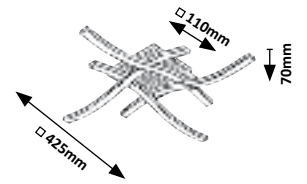

QUINCE



3084

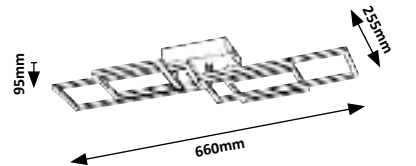

2280

(M) (P)

LED / 12W
 (E) 700lm; (E) 1050lm, 3000K incl.
 IP20
 matte black/white



2281

(M) (P)

LED / 20W
 (E) 1300lm; (E) 1800lm, 3000K incl.
 IP20
 matte black/white



3084

(M) (P)

LED / 40W
 (E) 2400lm; (E) 4350lm, 4000K incl.
 IP20
 black/white



TATJANA

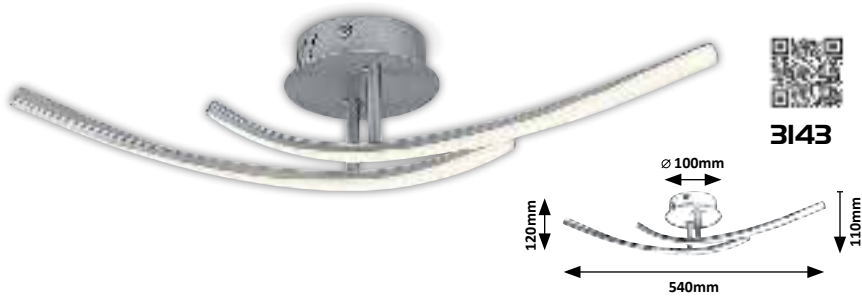

3143



3145



3144

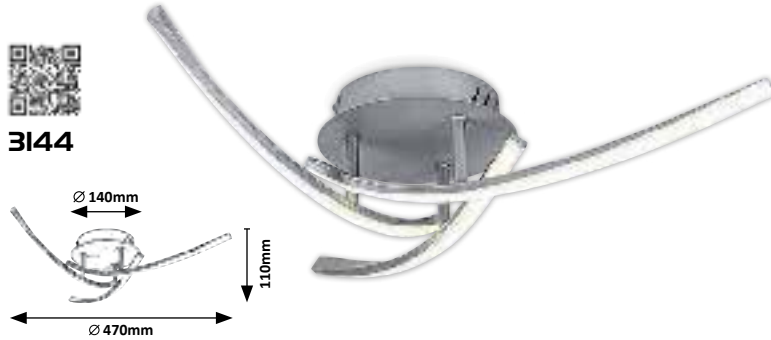

NAYARA

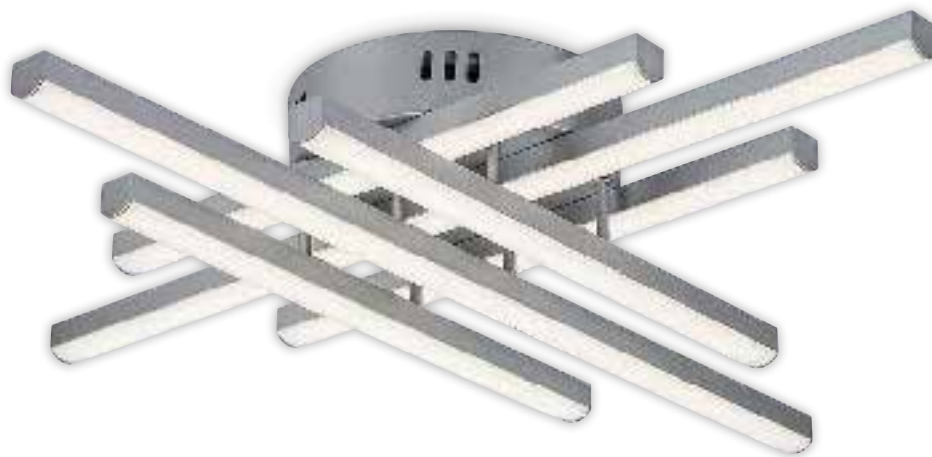

3014

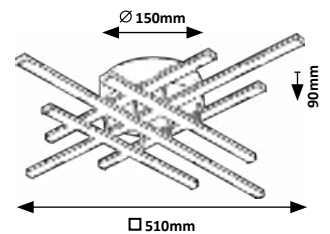

3143



LED / 15W
 (☰) 1000lm; (☲) 1550lm, 4000K incl.
 IP20
 silver/white



3144



LED / 22W
 (☰) 1400lm; (☲) 2300lm, 4000K incl.
 IP20
 silver/white



3145



LED / 30W
 (☰) 1950lm; (☲) 3000lm, 4000K incl.
 IP20
 silver/white



3014



LED / 40W
 (☰) 2050lm; (☲) 4000lm, 4000K incl.
 IP20
 silver/white



SIGURD

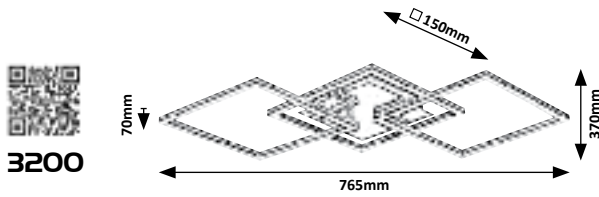

3200

FULVIA

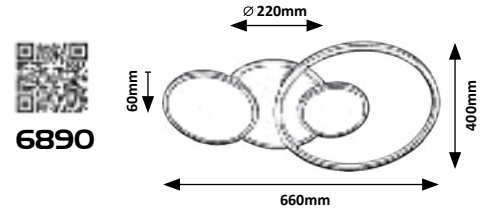

6890

CESARIO

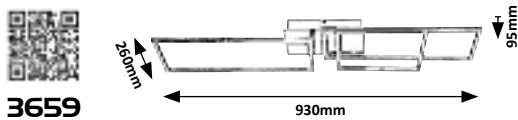

3659

3200 (M) (P)

LED / 43W
 (E) 2900lm; (E) 3900lm, 3000K) incl.
 IP20
 chrome/white



3659 (M) (P)

LED / 44W
 (E) 3100lm; (E) 4300lm, 4000K) incl.
 IP20
 chrome/white



6890 (M) (A)

LED / 50W
 (E) 3200lm; (E) 5700lm, 3000K) incl.
 IP20
 satin chrome/white



5445-5450



DANNY



5445

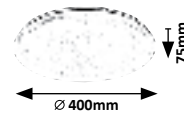

5447

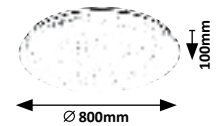

5446

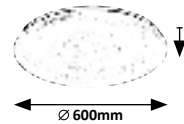

5448

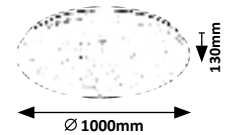

5449

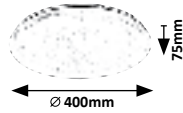

5450

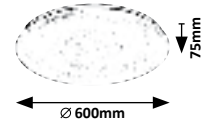

5445 (M) (P)

LED / 36W
(3000lm, 3000K-6500K) incl.
IP20 • 19758
539 • white



5 902250 354473

5446 (M) (P)

LED / 60W
(4800lm, 3000K-6500K) incl.
IP20 • 19759
539 • white

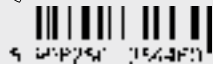

5 902250 354474

5447 (M) (P)

LED / 80W
(6400lm, 3000K-6500K) incl.
IP20 • 19760
502 • white



5 902250 354477

5448 (M) (P)

LED / 80W
(6400lm, 3000K-6500K) incl.
IP20 • 19761
502 • white



5 902250 354478

5449 (M) (P)

LED / 36W
(3000lm, 3000K-6500K) incl.
IP20 • 19762
539 • white



5 902250 354479

5450 (M) (P)

LED / 60W
(4800lm, 3000K-6500K) incl.
IP20 • 19763
539 • white



5 902250 354480

IGOR

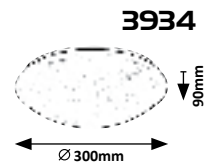

TREVOR



3008

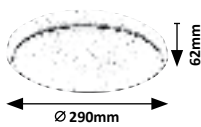

3009

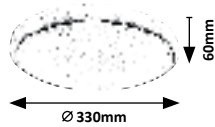

3010

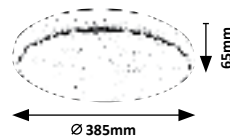

3934



3934 (M) (P)

LED / 16W
(1150lm, 3000K-6500K) incl.
IP20 • 19751 • 518
white



5 90250 333344

3008 (M) (A)

LED / 12W
(780lm, 3000K) incl.
IP20 • 19903
white

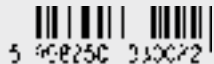

5 90250 330072

3009 (M) (A)

LED / 18W
(1170lm, 3000K) incl.
IP20 • 19904
white



5 90250 330059

3010 (M) (A)

LED / 24W
(1560lm, 3000K) incl.
IP20 • 19905
white

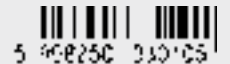

5 90250 330105

71018

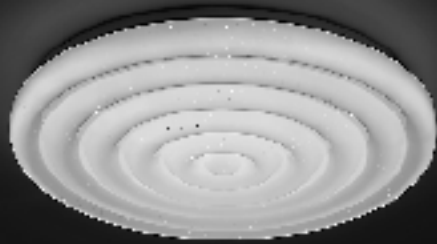

KATINA



NATURAL White

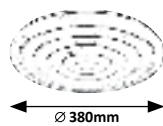

71017

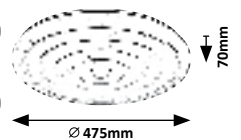

71018

71017 (M) (P)

LED / 24W
(2050lm, 2400lm;
4000K) incl. • IP20 • 19367
white



4 746296 710170

71018 (M) (P)

LED / 36W (3070lm, 3600lm;
3000K-6500K) incl.
IP20 • 19368 • 539
white



4 746296 710187

COOPERIUS



71003



71003

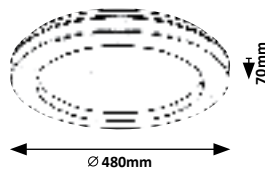

71003 **M P**

LED / 47W (83800lm, 84800lm;
3000K-6500K) incl.

IP20 • 19614 • 502
white



4 746294 7 7013

I507, I508, I509



MASON



I507

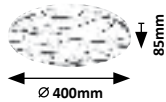

I508

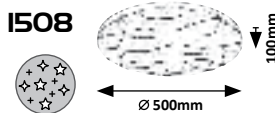

I509

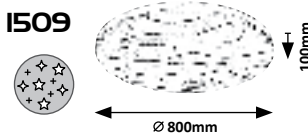

I507

(M) (P)

LED / 24W
(2000lm, 3000K-6500K) incl.
IP20 • 19720 • 502
white



S 36225C 215272

I508

(M) (P)

LED / 50W
(4500lm, 3000K-6500K) incl.
IP20 • 19721 • 502
white



S 36225C 215280

I509

(M) (P)

LED / 80W
(7200lm, 3000K-6500K) incl.
IP20 • 19722 • 502
white



S 36225C 215290

ELDRICK



3086

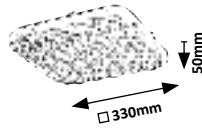

3087

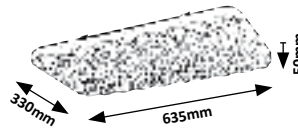

3086 (M) (P)

LED / 24W
(1800lm, 4000K) incl.
IP20 • 19956
white



3087 (M) (P)

LED / 36W
(2800lm, 4000K) incl.
IP20 • 19957
white





LAGERTHA

-
-
-
-

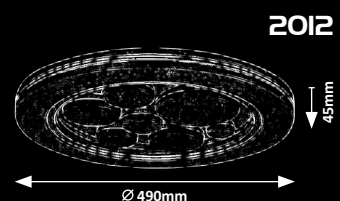

OCTAV

-
-
-
-

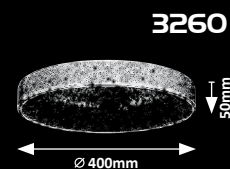

2012

LED / 36W
 (2200lm, 4000K) incl.
 IP20 • 19950
 chrome/white



5 938253 320120

3260

LED / 26W
 (1660lm, 4000K) incl.
 IP20 • 19987
 silver/white



5 938253 326064

OSWALD



5066

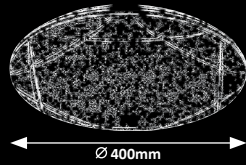

DANUTA



6490

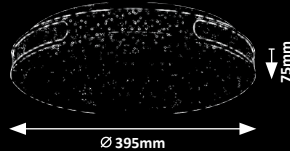

5066 (M) (P)

LED / 24W
(1800lm, 4000K) incl.
IP20 • 19995
silver/white



6490 (M) (P)

LED / 24W
(1730lm, 4000K) incl.
IP20 • 19996
chrome/white



3000



OFF

ON



rabalux®

VALTER



3750

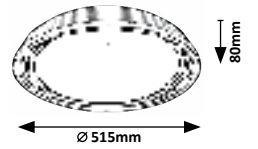

MATEA



3000

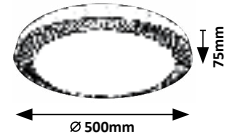

3750 (M P)

LED / 36W
(2250lm, 3000K) incl.
IP20 • 19891
brown/white

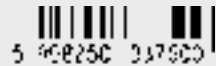

5 90250 337500

3000 (M A)

LED / 40W
(3200lm, 3000K-6000K) incl.
IP20 • 19639 • 502
brown/gold/white

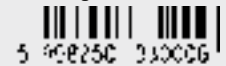

5 90250 330000

MOKKA

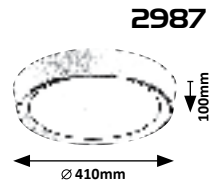

2987

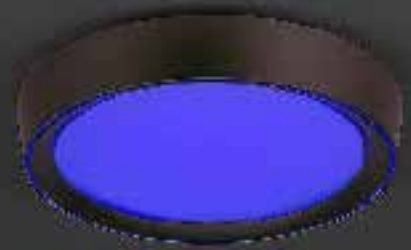

2987

(M) (A)

LED / 24W
(2000lm, 3000K-6000K) incl.
IP20 • 19642 • 519
brown/white

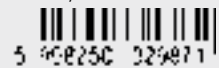

5 90250 329071



ENGON



71126



Ø 270mm



71128



Ø 380mm



71130



Ø 480mm

71126



LED / 18W
 (940lm, 1800lm;
 3000K) incl. • IP20
 black/white



4 742 946 7 1126 0

71128



LED / 24W
 (1400lm, 2600lm;
 3000K) incl. • IP20
 black/white



4 742 946 7 1128 0

71130



LED / 45W
 (2940lm, 4600lm;
 3000K) incl. • IP20
 black/white



4 742 946 7 1130 0

ENGON

5
YEAR
GUARANTEE

LED
built-in

NATURAL
White

PLASTIC

G A ↑ G

New



71127

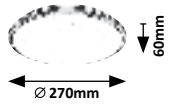

71129

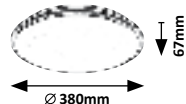

71131

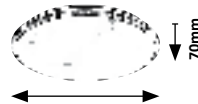

71127

(P)

LED / 18W
(1220lm, 1800lm;
4000K) incl. • IP20
silver/white



= 476296 71127

71129

(P)

LED / 24W
(1620lm, 2600lm;
4000K) incl. • IP20
silver/white



= 476296 71129

71131

(P)

LED / 45W
(3300lm, 4600lm;
4000K) incl. • IP20
silver/white



= 476296 71131

EPORA



7118

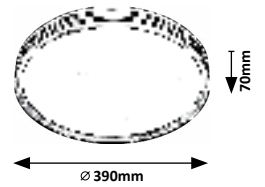

NESSIRA



71120

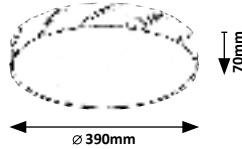

7119

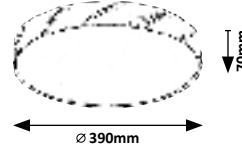

7118 (M P)

LED / 25W
 (1120lm, 2880lm;
 3000K) incl. • IP20 • 20021
 matte black/white



7119 (M P)

LED / 25W
 (1400lm, 2880lm;
 3000K) incl. • IP20 • 20007
 matte white



7120 (M P)

LED / 25W
 (1100lm, 3000lm;
 4000K) incl. • IP20 • 20007
 matte black/white



LIATRIS



71121

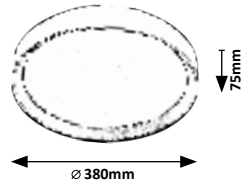

71121



JASNA



5196

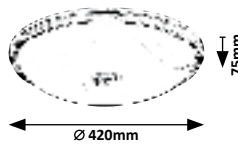

71119



71118



71121

M P

LED / 25W
 (11110lm, 2880lm;
 3000K) incl. • IP20 • 20008
 grey/white



5196

M G

LED / 24W
 (1920lm, 2700K) incl.
 IP20 • 19861
 antique bronze/white

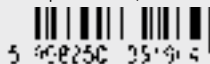



TAYTUM



7117

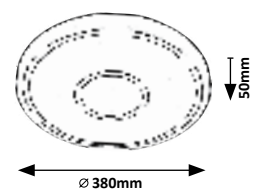

7117 (M) (P)

LED / 25W
(1680lm, 2880lm;
3000K) incl. • IP20 • 20020
white



BENITA

5 YEAR GUARANTEE

LED built-in

designed by **rabalux**

NATURAL White



3077

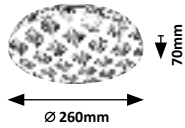

3078

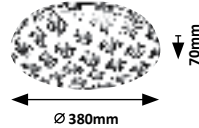

3077, 3078



3075, 3076



WARM White



3075

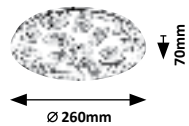

3076

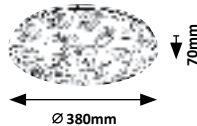

3075 (M P)

LED / 18W
(900lm, 3000K) incl.
IP20 • 19910
white



5 902250 330754

3076 (M P)

LED / 24W
(1200lm, 3000K) incl.
IP20 • 19911
white

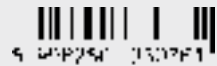

5 902250 330761

3077 (M P)

LED / 18W
(900lm, 4000K) incl.
IP20 • 19912
white

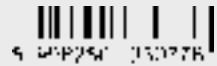

5 902250 330778

3078 (M P)

LED / 24W
(1200lm, 4000K) incl.
IP20 • 19913
white

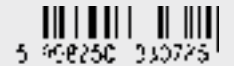

5 902250 330785

OSCAR



2763

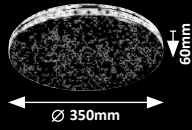

2764

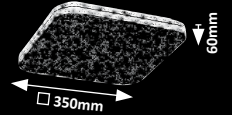

3411

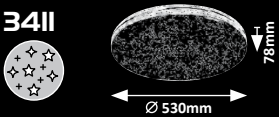

3409

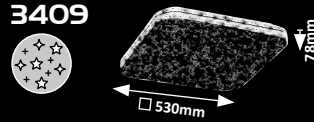

3410

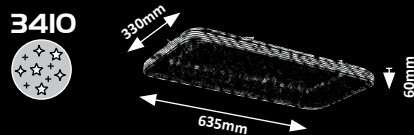

2763 (M) (P)

LED / 18W
(1350lm, 4000K) incl.
IP20 • 19707
white/walnut



5 368250 327631

2764 (M) (P)

LED / 18W
(1350lm, 4000K) incl.
IP20 • 19708
white/walnut



5 368250 32764E

3409 (M) (A)

LED / 36W
(2700lm, 4000K) incl.
IP20 • 19610
white/chrome



5 368250 334297

3410 (M) (A)

LED / 36W
(2520lm, 4000K) incl.
IP20 • 19862
white/chrome



5 368250 334100

3411 (M) (A)

LED / 36W
(2700lm, 4000K) incl.
IP20 • 19612
white/chrome



5 368250 334110

OSCAR



2783

NATURAL White

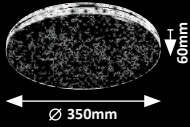

2784

NATURAL White

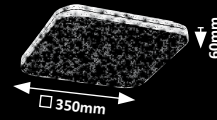

3345

WARM White

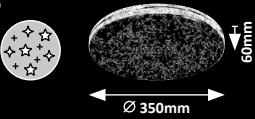

3346

WARM White

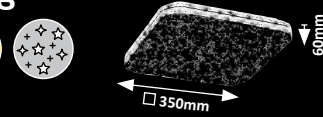

3347

NATURAL White

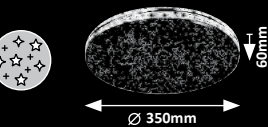

3348

NATURAL White

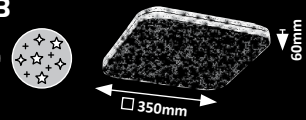

2783

(MP)

LED / 18W
(1350lm, 4000K) incl.
IP20 • 19709
white/chrome



S 392250 227830

2784

(MP)

LED / 18W
(1350lm, 4000K) incl.
IP20 • 19710
white/chrome



S 392250 227840

3345

(MP)

LED / 18W
(1350lm, 3000K) incl.
IP20 • 19818
white/walnut



S 392250 233450

3346

(MP)

LED / 18W
(1350lm, 3000K) incl.
IP20 • 19819
white/walnut



S 392250 233460

3347

(MP)

LED / 18W
(1350lm, 4000K) incl.
IP20 • 19820
white/chrome



S 392250 233470

3348

(MP)

LED / 18W
(1350lm, 4000K) incl.
IP20 • 19821
white/chrome



S 392250 233480

LUCAS



3072

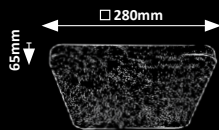

3073

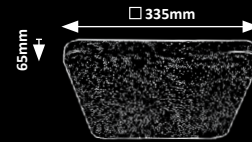

3074

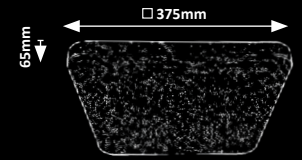

3072 (M) (P)

LED / 12W
(900lm, 4000K) incl.
IP20 • 19907
white



5 362250 330723

3073 (M) (P)

LED / 18W
(1350lm, 4000K) incl.
IP20 • 19908
white

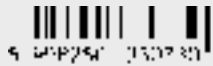

5 362250 330733

3074 (M) (P)

LED / 24W
(1800lm, 4000K) incl.
IP20 • 19909
white

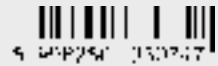

5 362250 330743

LUCAS

5 YEAR WARRANTY
LED built-in
NATURAL White



3936

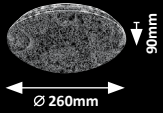

3937

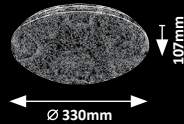

3938

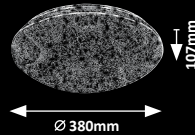

3434

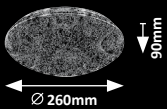

3435

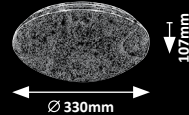

3436

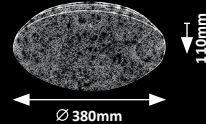

3936 (MP)

LED / 12W
(900lm, 4000K) incl.
IP20 • 19754
white



3937 (MP)

LED / 18W
(1350lm, 4000K) incl.
IP20 • 19755
white



3938 (MP)

LED / 24W
(1800lm, 4000K) incl.
IP20 • 19756
white



3434 (MP)

LED / 12W
(780lm, 4000K) incl.
IP20 • 19711
white



3435 (MP)

LED / 18W
(1170lm, 4000K) incl.
IP20 • 19712
white



3436 (MP)

LED / 24W
(1560lm, 4000K) incl.
IP20 • 19713
white



ROB



2284

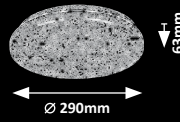

2285

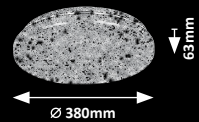

5435

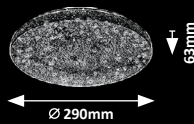

5436

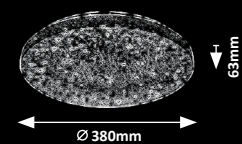

2284 (M P)

LED / 20W
(1400lm, 4000K) incl.
IP20 • 19676
white



S 362250 222841

2285 (M P)

LED / 32W
(2600lm, 4000K) incl.
IP20 • 19677
white



S 362250 222851

5435 (M P)

LED / 20W
(1400lm, 4000K) incl.
IP20 • 19826
white



S 362250 254351

5436 (M P)

LED / 32W
(2600lm, 4000K) incl.
IP20 • 19827
white



S 362250 254361

ROB



NATURAL White



2286

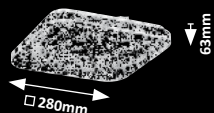

2287

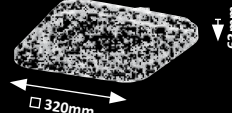

WARM White



3338

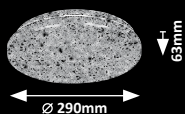

3339

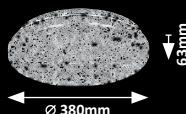

WARM White



3340

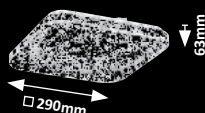

3344

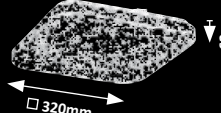

2286 (MP)

LED / 20W
(1400lm, 4000K) incl.
IP20 • 19678
white



2287 (MP)

LED / 32W
(2600lm, 4000K) incl.
IP20 • 19679
white



3338 (MP)

LED / 20W
(1400lm, 3000K) incl.
IP20 • 19914
white



3339 (MP)

LED / 32W
(2600lm, 3000K) incl.
IP20 • 19915
white



3340 (MP)

LED / 20W
(1400lm, 3000K) incl.
IP20 • 19916
white



3344 (MP)

LED / 32W
(2600lm, 3000K) incl.
IP20 • 19917
white



VENDEL



WARM White

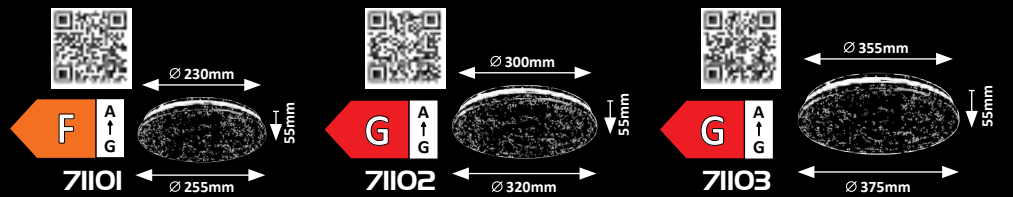

NATURAL White

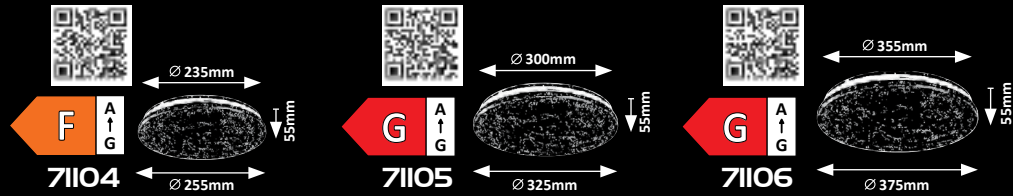

71101 (M P)

LED / 12W
 (1050lm, 1200lm;
 3000K) incl. • IP20
 20001 • white



71102 (M P)

LED / 18W
 (1450lm, 1800lm;
 3000K) incl. • IP20
 20002 • white



71103 (M P)

LED / 24W
 (1850lm, 2400lm;
 3000K) incl. • IP20
 20003 • white



71104 (M P)

LED / 12W
 (1150lm, 1200lm;
 4000K) incl. • IP20
 20004 • white



71105 (M P)

LED / 18W
 (1460lm, 1800lm;
 4000K) incl. • IP20
 20005 • white



71106 (M P)

LED / 24W
 (1970lm, 2400lm;
 4000K) incl. • IP20
 20006 • white



VENDEL



New



71107

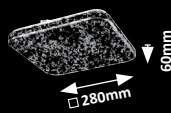

71108

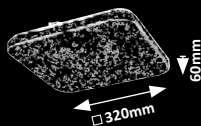

71109

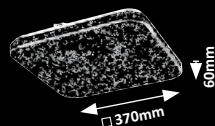

71107



LED / 12W
 (10000lm, 12000lm;
 3000K) incl. • IP20
 19451 • white



476295 71107

71108



LED / 18W
 (1350lm, 1800lm;
 3000K) incl. • IP20
 19508 • white



476295 71108

71109



LED / 24W
 (1570lm, 2400lm;
 3000K) incl. • IP20
 19613 • white



476295 71109



DAMEK



2173

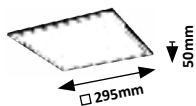

2174

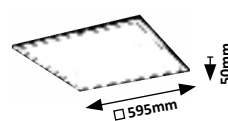

2175

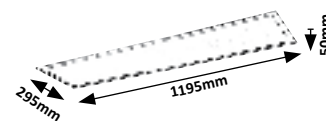

2173

MP

LED / 12W
(1260lm, 4000K) incl.
IP20
white



2174

MP

LED / 40W
(4200lm, 4000K) incl.
IP20
white



2175

MP

LED / 40W
(4200lm, 4000K) incl.
IP20
white



TALEB



2191

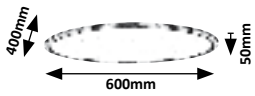

2192

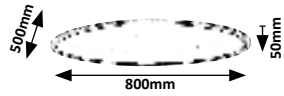

2193

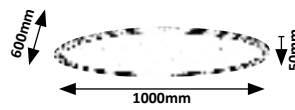

2191, 2192, 2193

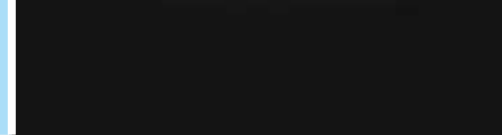
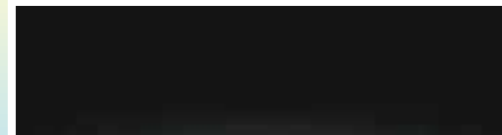

2191 (M) (P)

LED / 40W
(3200lm, 3000K-6000K) incl.
IP20 • 527
silver/white



5 362250 321312

2192 (M) (P)

LED / 50W
(4000lm, 3000K-6000K) incl.
IP20 • 527
silver/white



5 362250 321320

2193 (M) (P)

LED / 60W
(4800lm, 3000K-6000K) incl.
IP20 • 527
silver/white



5 362250 321330



RORIK



71123

Ø 280mm



71124

Ø 380mm



71125

Ø 480mm

71123



LED / 18W
(1600lm, 1900lm;
4000K) incl. • IP20
white



4 742 96 7 1123

71124



LED / 24W
(2250lm, 2600lm;
4000K) incl. • IP20
white



4 742 96 7 1124

71125



LED / 45W
(3930lm, 5000lm;
4000K) incl. • IP20
white



4 742 96 7 1125

PAVEL



3427

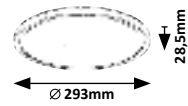

3428

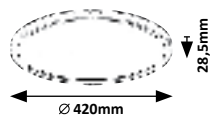

3429

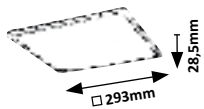

3430

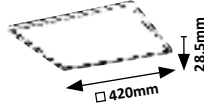

3278

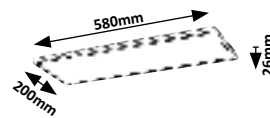

3427



LED / 18W
(1700lm, 4000K) incl.
IP20
white



5 908250 334271

3428



LED / 22W
(2200lm, 4000K) incl.
IP20
white

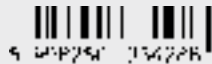

5 908250 334288

3429



LED / 18W
(1700lm, 4000K) incl.
IP20
white

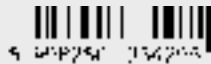

5 908250 334295

3430



LED / 22W
(2200lm, 4000K) incl.
IP20
white

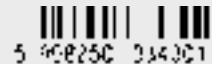

5 908250 334301

3278



LED / 22W
(2200lm, 4000K) incl.
IP20
white



5 908250 332779



ALMOND

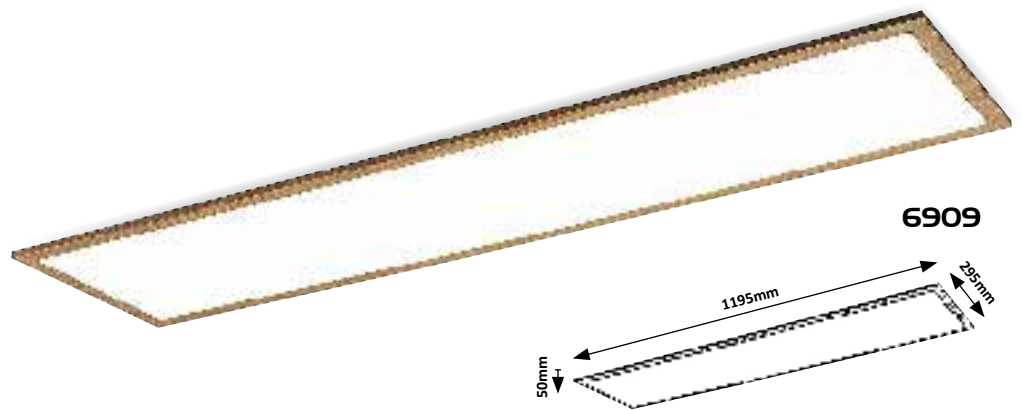
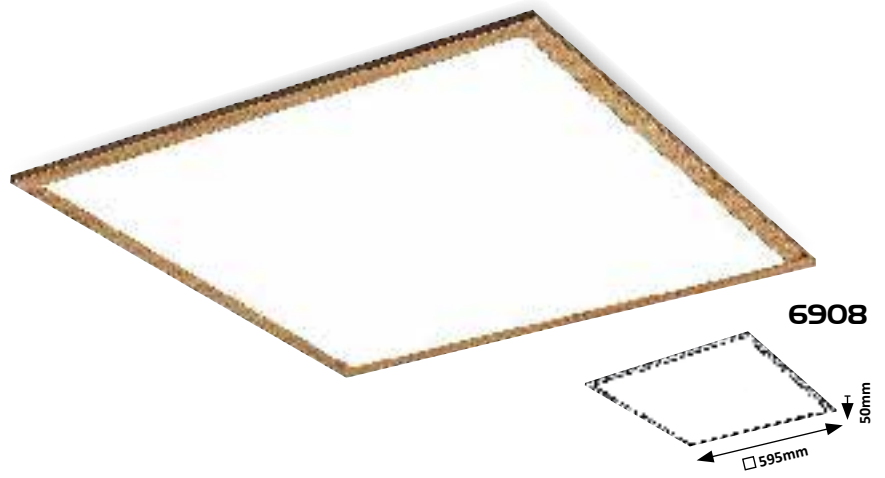
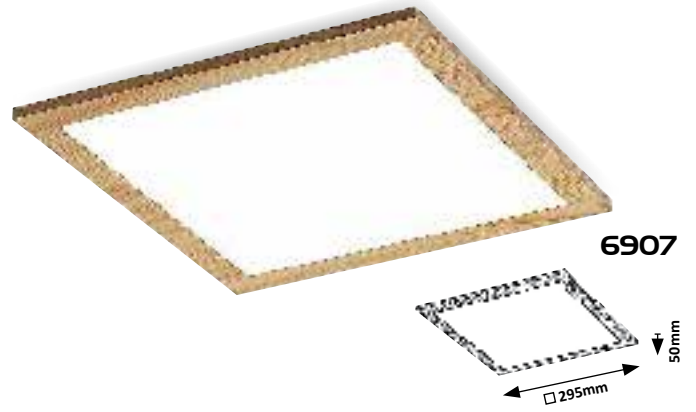

6907 (M) (P)

LED / 12W
(1260lm, 4000K) incl.
IP20
beech/white



6908 (M) (P)

LED / 40W
(4200lm, 4000K) incl.
IP20
beech/white



6909 (M) (P)

LED / 40W
(4200lm, 4000K) incl.
IP20
beech/white



TAMINO

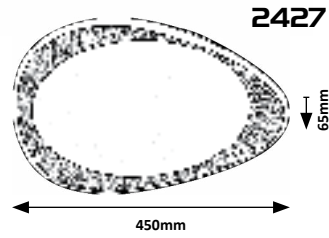

2427 (M) (A)

LED / 24W
(1200lm, 4000K) incl.
IP20 • 19967
beech/white



3500



SHERWOOD

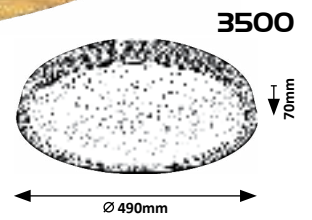

LEANA

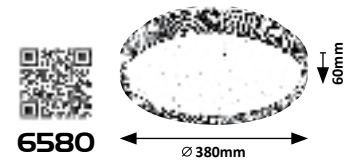
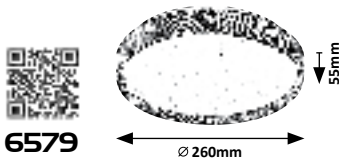

3500 (M P)

LED / 50W
(4000lm, 3000K-6500K) incl.
IP20 • 19990 • 502
beech/white



6579 (M P)

LED / 12W
(700lm, 3000K) incl.
IP20 • 19993
beech/white



6580 (M P)

LED / 24W
(1300lm, 3000K) incl.
IP20 • 19994
beech/white



MAPLE



3527

WARM
White

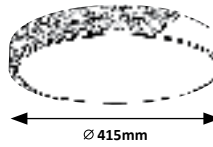

3528

NATURAL
White

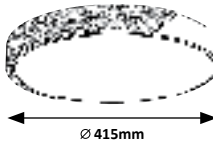

3527 MWP

LED / 24W
(1760lm, 3000K) incl.
IP20 • 19947
matte white/beece



5 938253 35278

3528 MWP

LED / 24W
(1890lm, 4000K) incl.
IP20 • 19947
matte black/beece/white



5 938253 35288



3283



FOSTER



3283

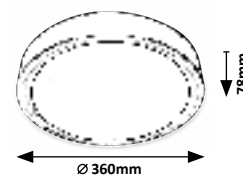

SONNET

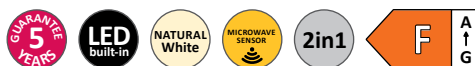

I491

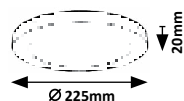

I492

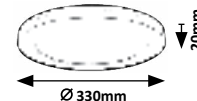

3283 (M P)

LED / 28W
(1300lm, 2700K-5000K) incl.
IP20 • 543 • 1-5m, 120°
black/white

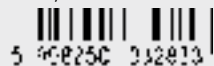

5 362250 314213

I491 (M P)

LED / 18W
(1880lm, 4000K) incl.
IP20 • white • 8m, 130°
65-205mm • 70mm



5 362250 314214

I492 (M P)

LED / 30W
(2800lm, 4000K) incl.
IP20 • white • 8m, 130°
65-305mm • 70mm



5 362250 314221

LARCIA



750II

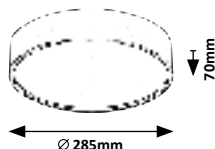

750I2

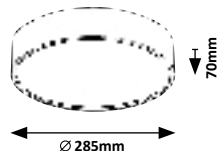

750II



LED / 19W
(1000lm, 1900lm;
4000K) incl. • IP44 • 6m, 120°
20010 • black/white



4 742 94 75 71 4

750I2



LED / 19W
(1070lm, 1900lm;
4000K) incl. • IP44 • 6m, 120°
20011 • white



4 742 94 75 71 1

I49I, I492 750II, 750I2

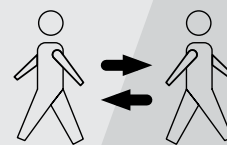
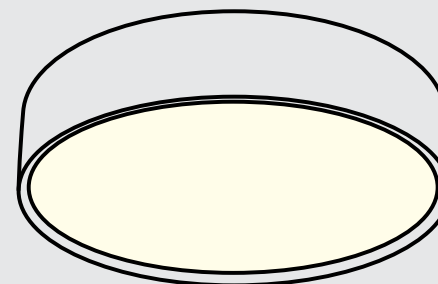
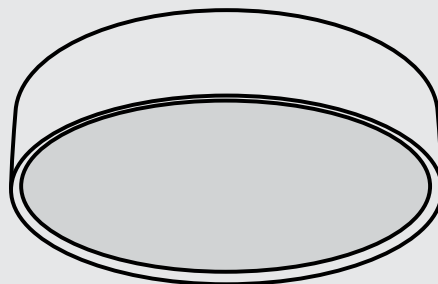

adjustable • állítható • einstellbar

	1	2	Detection Area	3	4	5	Hold Time	6	7	8	Daylight Sensor
I	ON	ON	100%	ON	ON	ON	5s	ON	ON	ON	2Lux
II	ON	-	75%	ON	ON	-	30s	ON	ON	-	10Lux
III	-	ON	50%	ON	-	ON	1min	-	ON	-	25Lux
IV	-	-	25%	ON	-	-	3min	ON	-	-	50Lux
V				-	ON	ON	5min	-	-	-	Disable
VI				-	ON	-	10min				
VII				-	-	ON	20min				
VIII				-	-	-	30min				

VENDEL



75013

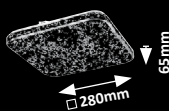

75014

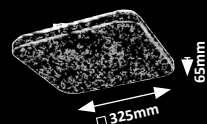

75015

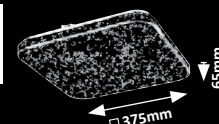

75013 (M) (P)

LED / 12W
 (1000lm, 1200lm;
 4000K) incl. • IP20 • 6m, 120°
 19451 • white



75014 (M) (P)

LED / 20W
 (1400lm, 2000lm;
 4000K) incl. • IP20 • 6m, 120°
 19508 • white



75015 (M) (P)

LED / 24W
 (1460lm, 2400lm;
 4000K) incl. • IP20 • 6m, 120°
 19613 • white





71B2

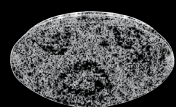

Ø 265mm

100mm



71B3

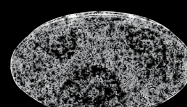

Ø 335mm

105mm



71B4

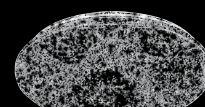

Ø 380mm

105mm

75013, 75014, 75015, 71B2, 71B3, 71B4

adjustable • állítható • einstellbar

	1	2	Detection Area	3	4	5	Hold Time	6	7	8	Daylight Sensor
I	ON	ON	100%	ON	ON	ON	5s	ON	ON	ON	2Lux
II	ON	-	75%	ON	ON	-	30s	ON	ON	-	10Lux
III	-	ON	50%	ON	-	ON	1min	-	ON	-	25Lux
IV	-	-	25%	ON	-	-	3min	ON	-	-	50Lux
V				-	ON	ON	5min	-	-	-	Disable
VI				-	ON	-	10min				
VII				-	-	ON	20min				
VIII				-	-	-	30min				

71B2



LED / 12W
 (830lm, 1200lm;
 4000K) incl. • IP44 • 6m, 120°
 19714 • white



476295 711720

71B3



LED / 18W
 (1180lm, 1800lm;
 4000K) incl. • IP44 • 6m, 120°
 19715 • white



476295 711717

71B4



LED / 24W
 (1750lm, 2400lm;
 4000K) incl. • IP44 • 6m, 120°
 19716 • white



476295 711734

04

**WALL AND CEILING LAMPS,
PENDANTS**

**FALI- ÉS MENNYEZETLÁMPÁK,
FÜGGESZTÉKEK**

**WAND- UND DECKENLEUCHTEN,
PENDELLEUCHTEN**





HOLDEN

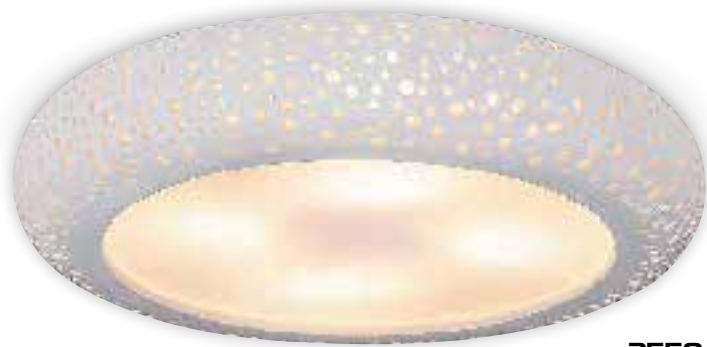

2558

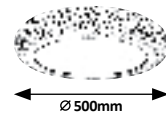

2804

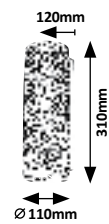

2558 (M) (PL)
☒ E27 / 4x max. 25W
IP20 • 19580
white



2804 (M) (PL)
☒ E14 / 2x max. 40W
IP20 • 19533
white



ART GOLD



1940

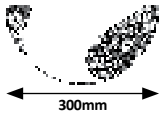

1941

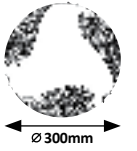

1942

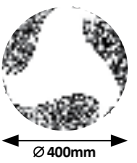

LARETTA



3712

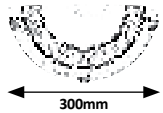

3713

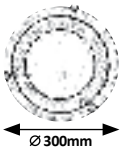

3714

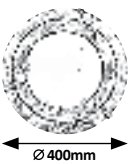

1940



☒ E27 / 1x max. 60W
IP20 • 1390
white/gold



5 362250 313407

1941



☒ E27 / 1x max. 60W
IP20 • 1391
white/gold



5 362250 313414

1942



☒ E27 / 2x max. 60W
IP20 • 1392
white/gold



5 362250 313421

3712



☒ E27 / 1x max. 60W
IP20 • 9612
alabaster/gold/bronze



5 362250 337126

3713



☒ E27 / 1x max. 60W
IP20 • 9613
alabaster/gold/bronze



5 362250 337135

3714



☒ E27 / 2x max. 60W
IP20 • 9614
alabaster/gold/bronze

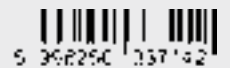

5 362250 337142

ETRUSCO



7647

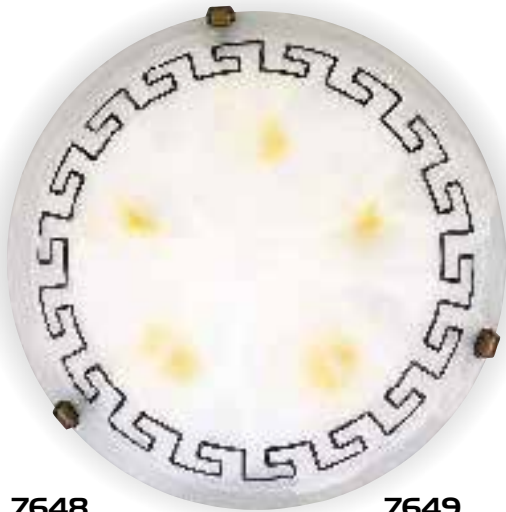
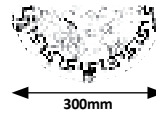

7652

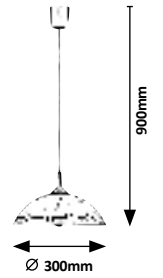

7648

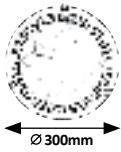

7649



7640

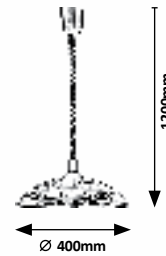

7640 **PG**

☒ E27 / 1x max. 60W
IP20 • 9233
alabaster/brown/bronze

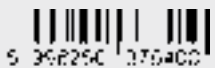

7647 **MG**

☒ E27 / 1x max. 60W
IP20 • 9234
alabaster/brown/bronze



7648 **MG**

☒ E27 / 1x max. 60W
IP20 • 9235
alabaster/brown/bronze



7649 **MG**

☒ E27 / 2x max. 60W
IP20 • 9236
alabaster/brown/bronze



7652 **PG**

☒ E27 / 1x max. 60W
IP20 • 9735
alabaster/brown/bronze



ALABASTRO



3053

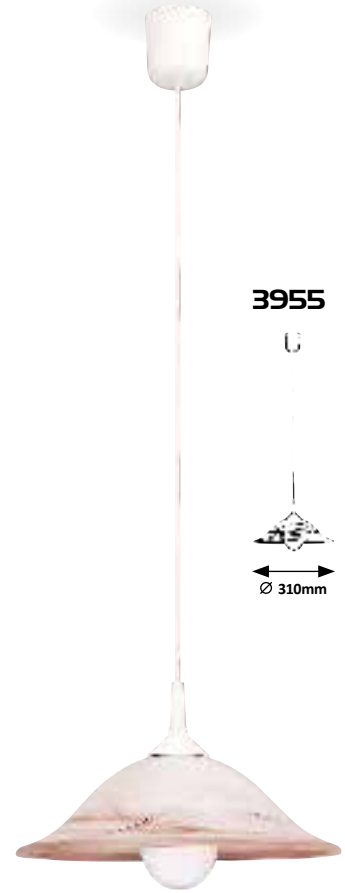
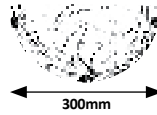

3955

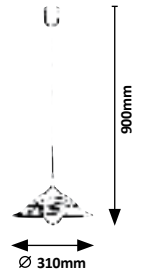

3253

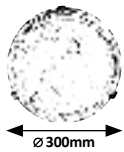

3353

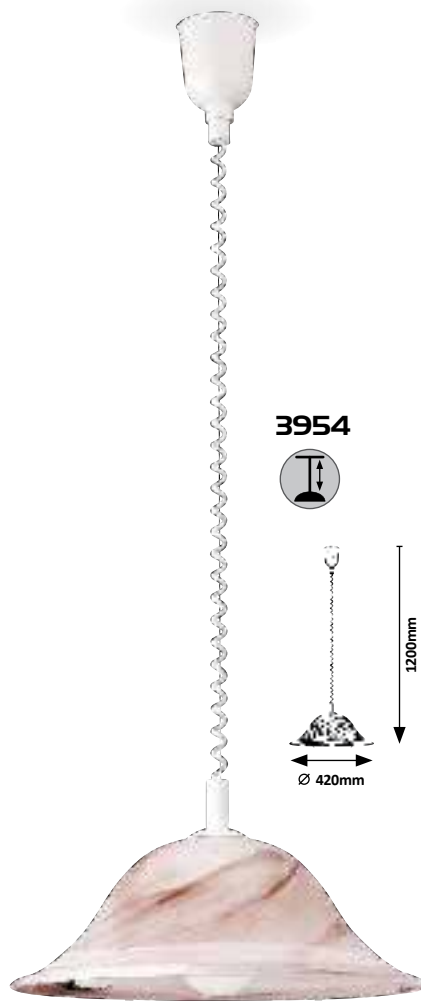
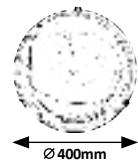

3954

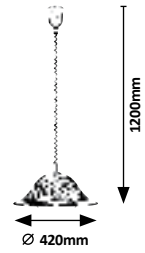

3053 **M G**

☒ E27 / 1x max. 60W
IP20 • 9123
alabaster/tobacco/bronze



5 362250 332532

3253 **M G**

☒ E27 / 1x max. 60W
IP20 • 9111
alabaster/tobacco/bronze



5 362250 332530

3353 **M G**

☒ E27 / 2x max. 60W
IP20 • 9117
alabaster/tobacco/bronze



5 362250 333533

3954 **P G**

☒ E27 / 1x max. 60W
IP20 • 9141
alabaster/tobacco/white



5 362250 333542

3955 **P G**

☒ E27 / 1x max. 60W
IP20 • 9135
alabaster/tobacco/white

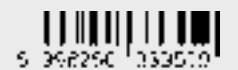

5 362250 333570

ALABASTRO



3001

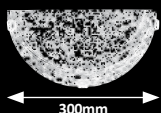

300mm



3201

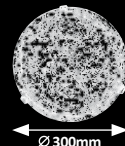

Ø 300mm

3301

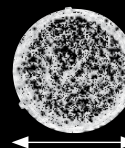

Ø 400mm



3002

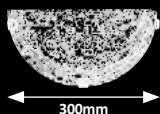

300mm



3202

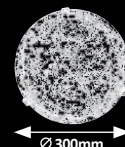

Ø 300mm

3302

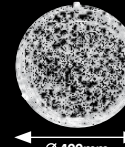

Ø 400mm



3001 **MG**

☒ E27 / 1x max. 60W
IP20 • 9119
alabaster/gold



5 362250 330213

3002 **MG**

☒ E27 / 1x max. 60W
IP20 • 9119
alabaster/chrome



5 362250 330220

3201 **MG**

☒ E27 / 1x max. 60W
IP20 • 9107
alabaster/gold



5 362250 330217

3202 **MG**

☒ E27 / 1x max. 60W
IP20 • 9107
alabaster/chrome



5 362250 330224

3301 **MG**

☒ E27 / 2x max. 60W
IP20 • 9113
alabaster/gold



5 362250 330214

3302 **MG**

☒ E27 / 2x max. 60W
IP20 • 9113
alabaster/chrome



5 362250 330221

ALABASTRO



3003



300mm



3203

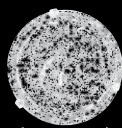

Ø 300mm

3303

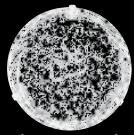

Ø 400mm

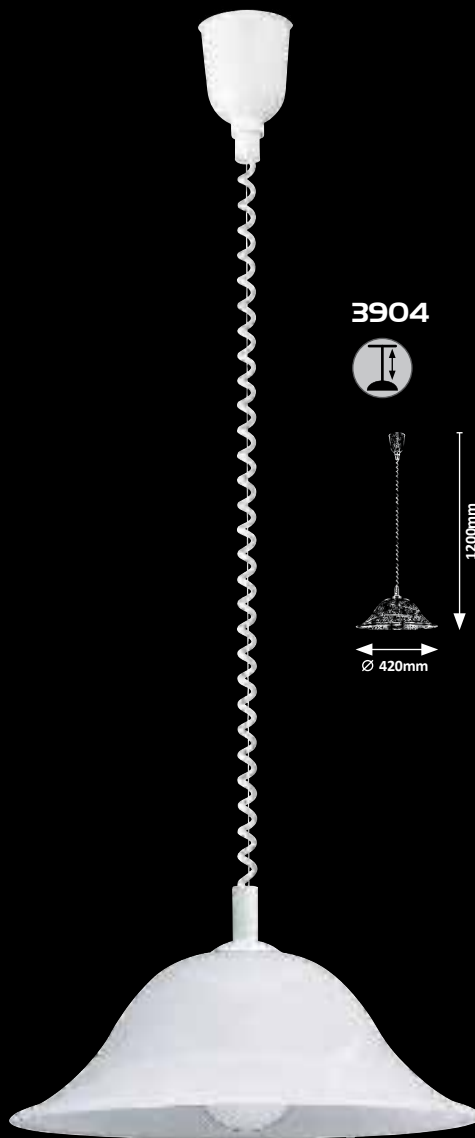

3904

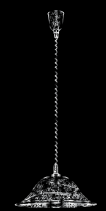

1200mm

Ø 420mm

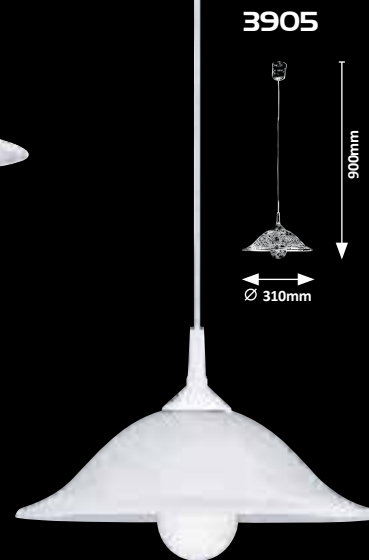

3905

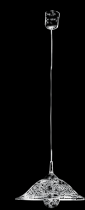

900mm

Ø 310mm

3003 **M G**

☒ E27 / 1x max. 60W
IP20 • 9119
alabaster/bronze



S 362250 333277

3203 **M G**

☒ E27 / 1x max. 60W
IP20 • 9107
alabaster/bronze



S 362250 333277

3303 **M G**

☒ E27 / 2x max. 60W
IP20 • 9113
alabaster/bronze



S 362250 333278

3904 **P G**

☒ E27 / 1x max. 60W
IP20 • 9137
alabaster/white



S 362250 333267

3905 **P G**

☒ E27 / 1x max. 60W
IP20 • 9131
alabaster/white



S 362250 333274

JOLLY

5 YEARS GUARANTEE



1960

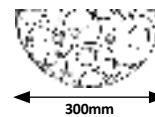

1861

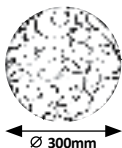

1862



1864

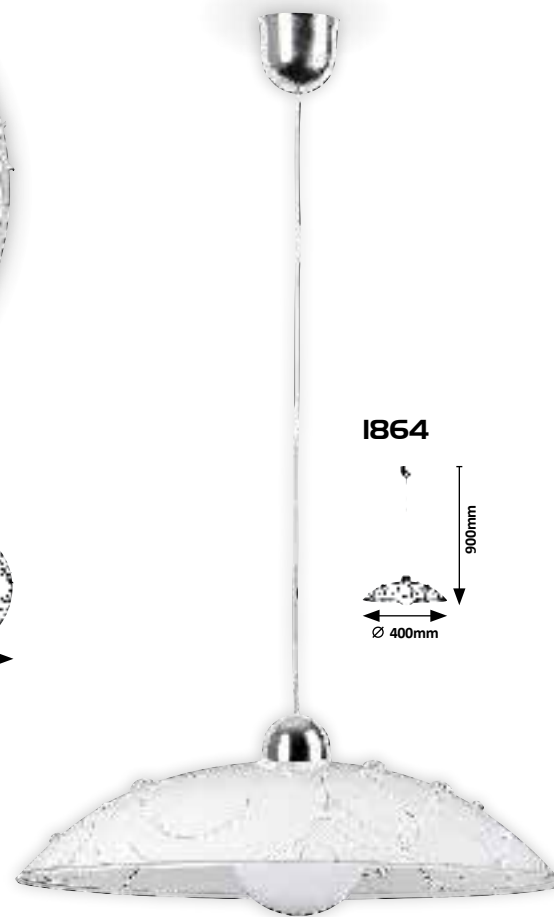

1861 **MG**

☒ E27 / 1x max. 60W
IP20 • 1195
white/transparent/chrome



S 362250 215022

1862 **MG**

☒ E27 / 2x max. 60W
IP20 • 1196
white/transparent/chrome



S 362250 215022

1864 **PG**

☒ E27 / 1x max. 60W
IP20 • 1198
white/transparent/chrome



S 362250 215020

1960 **MG**

☒ E27 / 1x max. 60W
IP20 • 1348
white/transparent/chrome



S 362250 213005

ELINA

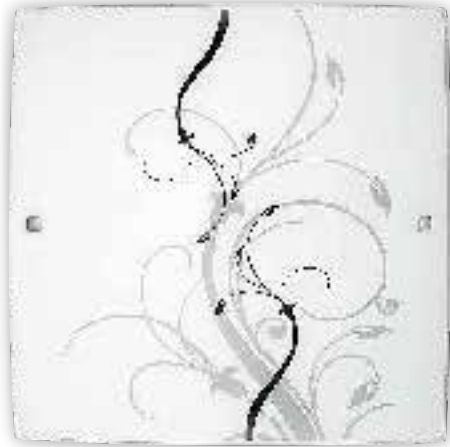

3692



3693

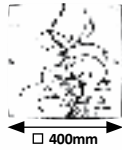

3691

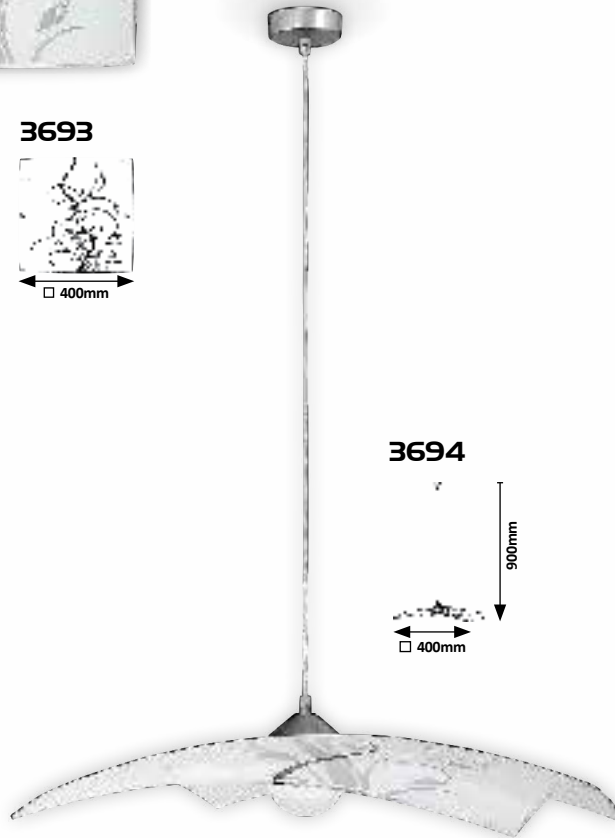
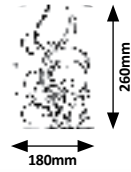

3694

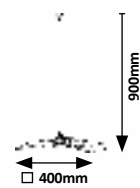

SMERLATO



4675

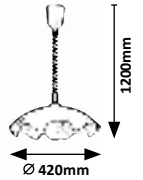

ROUND

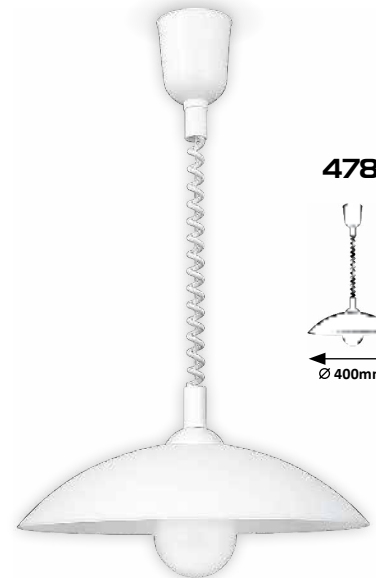

4780

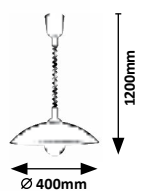

3691 **MG**
 ☒ E27 / G45 / 1x max. 60W
 IP20 • 1265
 white/grey/black

3692 **MG**
 ☒ E27 / 1x max. 60W
 IP20 • 1266
 white/grey/black

3693 **MG**
 ☒ E27 / 2x max. 60W
 IP20 • 1267
 white/grey/black

3694 **MG**
 ☒ E27 / 1x max. 60W
 IP20 • 1268
 white/grey/black/chrome

4675 **PG**
 ☒ E27 / 1x max. 60W
 IP20 • 9156
 white

4780 **PG**
 ☒ E27 / 1x max. 60W
 IP20 • 9182
 white



HARMONY LUX



Others /
Best match

263, 398



3851

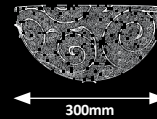

300mm

3852

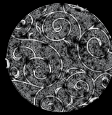

Ø 300mm

3853

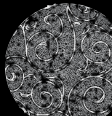

Ø 400mm



3851 **MG**

☒ E27 / 1x max. 60W
IP20 • 9297
white/transparent/chrome



S 362250 338514

3852 **MG**

☒ E27 / 1x max. 60W
IP20 • 9302
white/transparent/chrome



S 362250 338521

3853 **MG**

☒ E27 / 2x max. 60W
IP20 • 9334
white/transparent/chrome



S 362250 338532

HARMONY LUX

5
YEARS
WARRANTY

Others /
Best match
263, 398.



3850

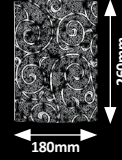

3854

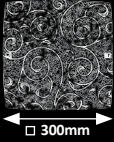

3855

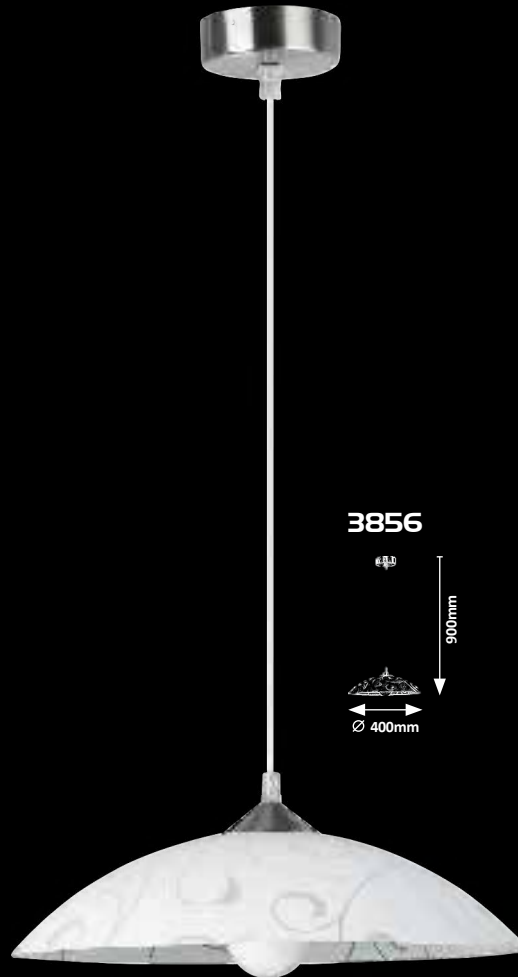
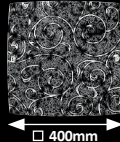

3856

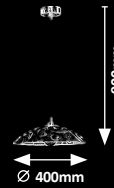

3850 **MG**

☒ E27 / 1x max. 60W
IP20 • 9403
white/transparent/chrome



S 36229C 338507

3854 **MG**

☒ E27 / 1x max. 60W
IP20 • 9404
white/transparent/chrome



S 36229C 338547

3855 **MG**

☒ E27 / 2x max. 60W
IP20 • 9408
white/transparent/chrome



S 36229C 338572

3856 **MG**

☒ E27 / 1x max. 60W
IP20 • 9427
white/transparent/chrome



S 36229C 338570

ADA

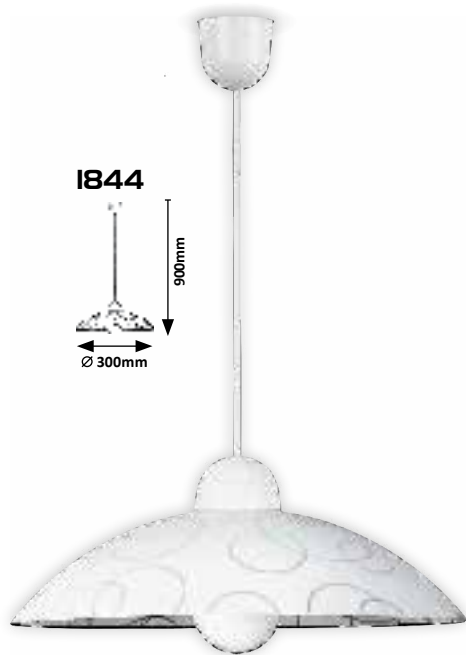

I844

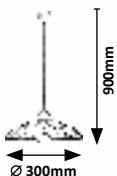

SCROLL

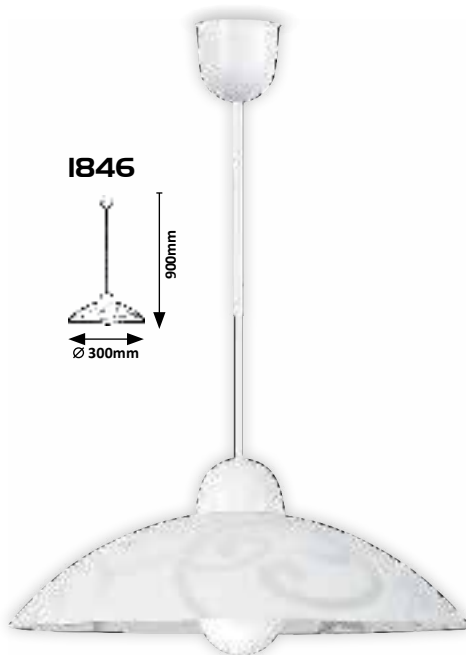

I846

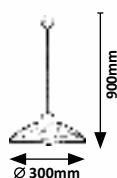

BLOOMY

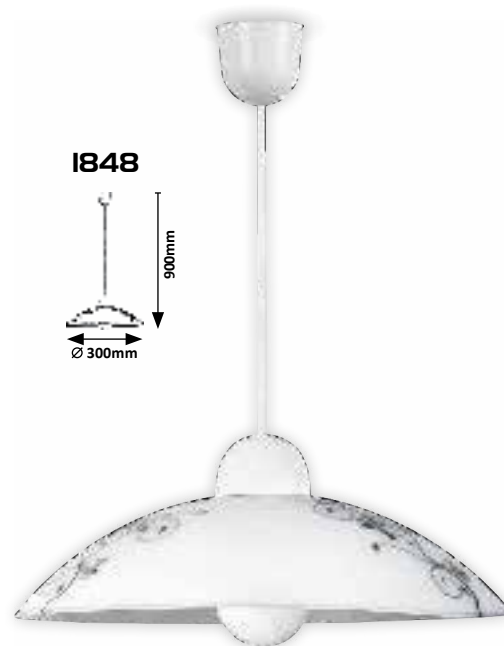

I848



I843



I845

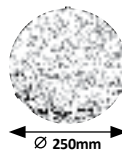

I847



I843 (M)(P)(G)

☒ E27 / 1x max. 60W
IP20 • 9682
white/transparent



I844 (P)(G)

☒ E27 / 1x max. 60W
IP20 • 9686
white/transparent



I845 (M)(P)(G)

☒ E27 / 1x max. 60W
IP20 • 9681
white/transparent



I846 (P)(G)

☒ E27 / 1x max. 60W
IP20 • 9685
white/transparent



I847 (M)(P)(G)

☒ E27 / 1x max. 60W
IP20 • 9272
white/black



I848 (P)(G)

☒ E27 / 1x max. 60W
IP20 • 9278
white/black



VINO



4782

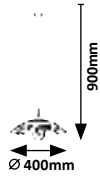

4795

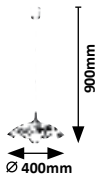

CUPOLA RANGE



4613

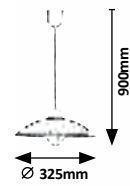

1408

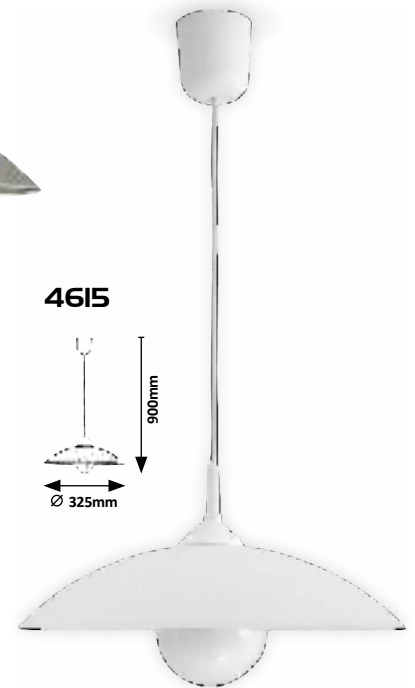
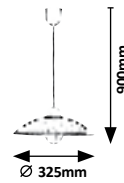

4615

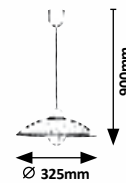

4782 (P) (G)

☒ E27 / 1x max. 60W
IP20 • 9184
white/orange



5 362250 347820

4795 (P) (G)

☒ E27 / 1x max. 60W
IP20 • 9186
white/silver



5 362250 347950

1408 (P) (G)

☒ E27 / 1x max. 60W
IP20 • 743
grey/white



5 362250 314082

4613 (P) (G)

☒ E27 / 1x max. 60W
IP20 • 9311
orange/white



5 362250 346137

4615 (P) (G)

☒ E27 / 1x max. 60W
IP20 • 9313
white



5 362250 346151

SPIRAL

5
GUARANTEE
YEARS



1822

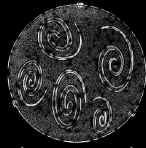

Ø 250mm

SIMPLE

5
GUARANTEE
YEARS

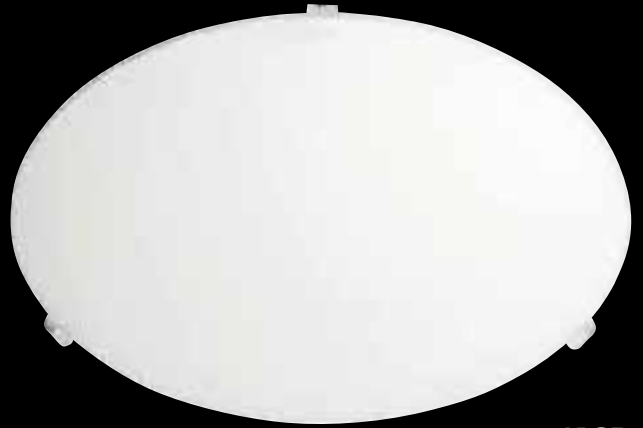

1803

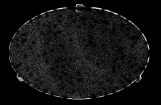

Ø 250mm

SOLEY

5
GUARANTEE
YEARS

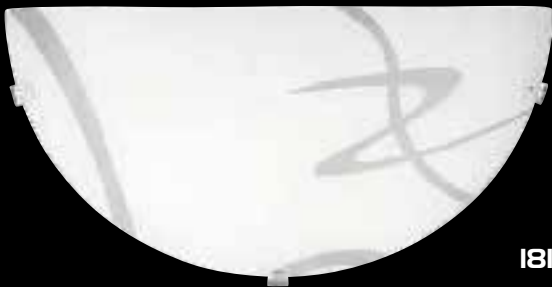

1817



300mm



1818



Ø 300mm

1819

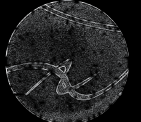

Ø 400mm

1822 M P G

☒ E27 / 1x max. 60W
IP20 • 9034
white/transparent



5 362250 315220

1803 M P G

☒ E27 / 1x max. 60W
IP20 • 9010
white/transparent



5 362250 315230

1818 M P G

☒ E27 / 1x max. 60W
IP20 • 9028
white/transparent



5 362250 315180

1819 M P G

☒ E27 / 2x max. 60W
IP20 • 9031
white/transparent



5 362250 315190

1817 M P G

☒ E27 / 1x max. 60W
IP20 • 9025
white/transparent



5 362250 315170

PHAEDRA



3697

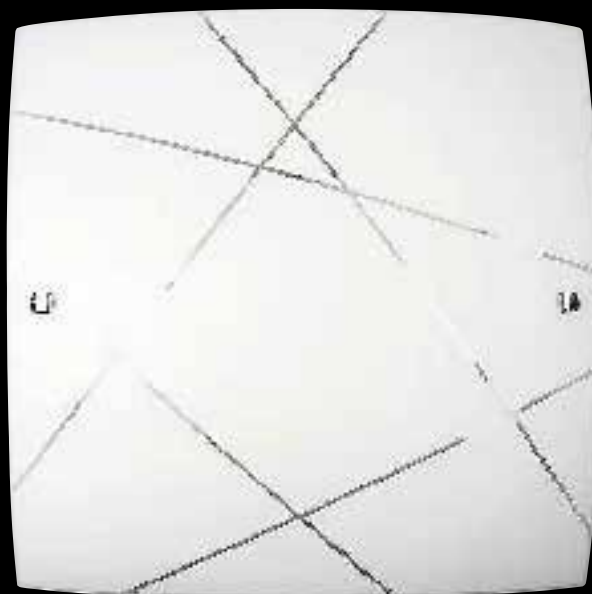
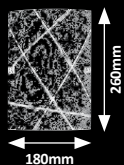

3698

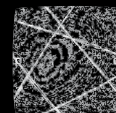

3699

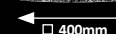
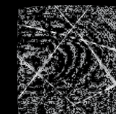

3697 **(M G)**

☒ E27 / G45 / 1x max. 60W
IP20 • 1344
white/chrome/transparent



3698 **(M G)**

☒ E27 / 1x max. 60W
IP20 • 1339
white/chrome/transparent



3699 **(M G)**

☒ E27 / 2x max. 60W
IP20 • 1340
white/chrome/transparent



NEDDA



3687

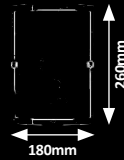

3688

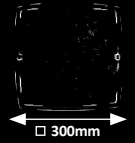

3689



SCOTTIE



3887

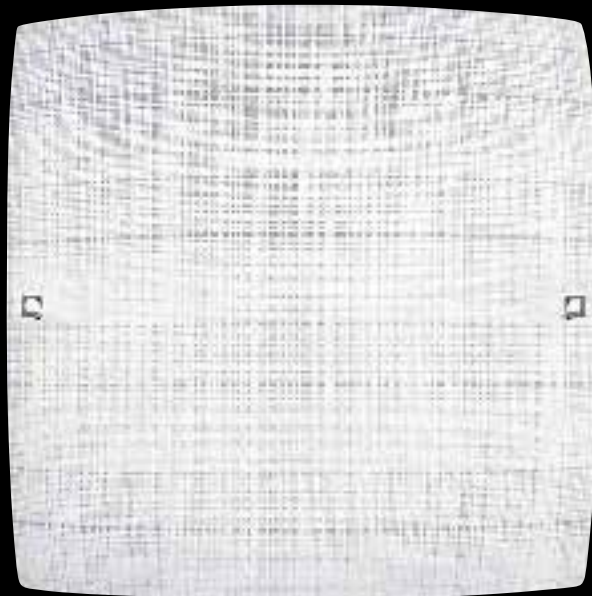
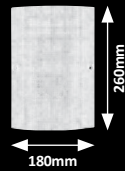

3888

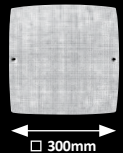

3889

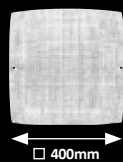

3687 **MG**

☒ E27 / 1x max. 60W
IP20 • 1319
opal glass/transparent



3688 **MG**

☒ E27 / 1x max. 60W
IP20 • 1346
opal glass/transparent



3689 **MG**

☒ E27 / 2x max. 60W
IP20 • 1347
opal glass/transparent



3887 **MG**

☒ E27 / G45 / 1x max. 60W
IP20 • 9373
white/chrome



3888 **MG**

☒ E27 / 1x max. 60W
IP20 • 9374
white/chrome



3889 **MG**

☒ E27 / 2x max. 60W
IP20 • 9375
white/chrome



OPALE

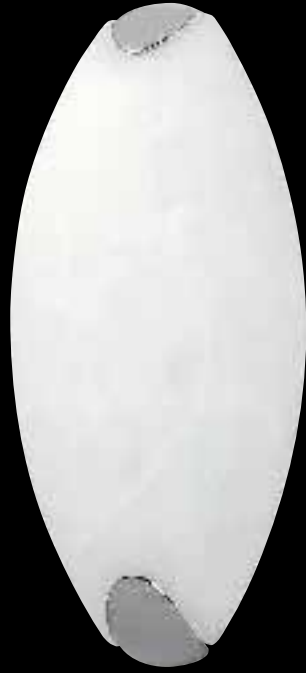

5726



GRACE



2431

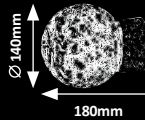

2432

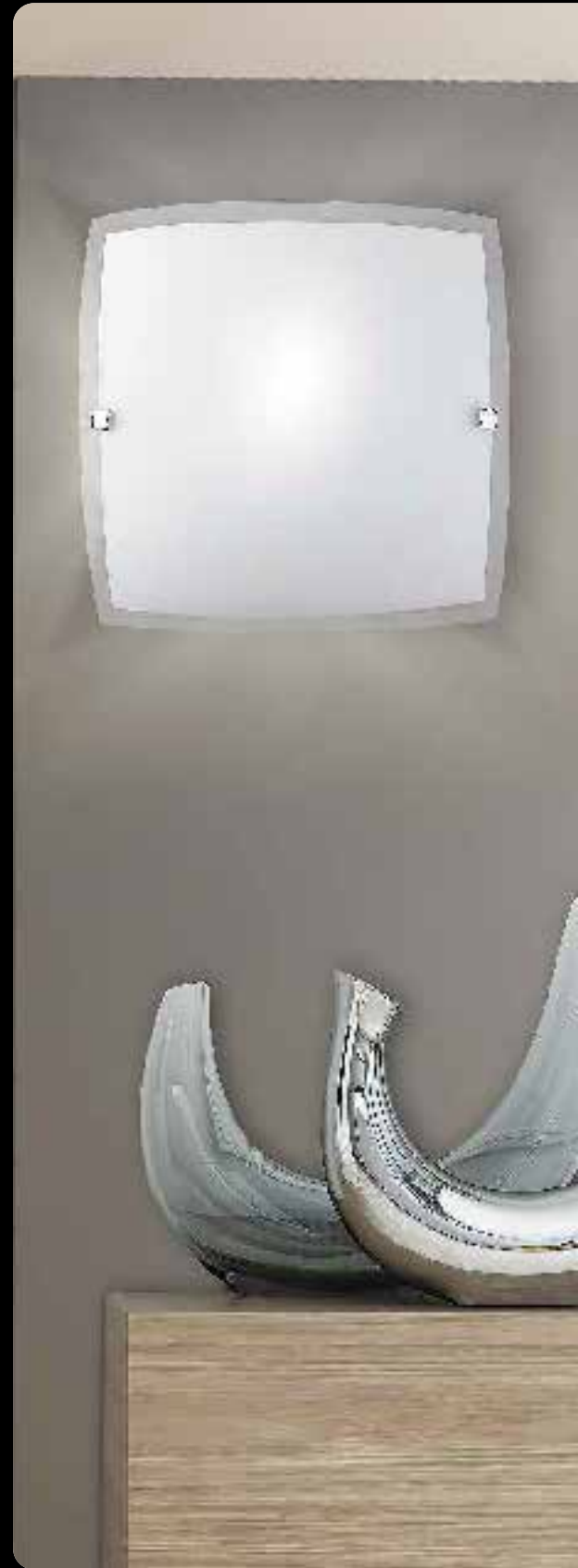
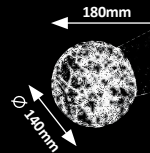

5726 **MG**

☒ E27 / 1x max. 60W
IP20 • 9512
chrome/alabaster



5 362250 357263

2431 **PG**

☒ E27 / 1x max. 60W
IP20 • 2416
white/transparent



5 362250 324310

2432 **PG**

☒ E27 / 1x max. 60W
IP20 • 2416
white/transparent



5 362250 324320

UFO



540I

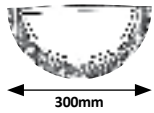

542I

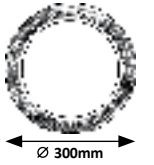

542I

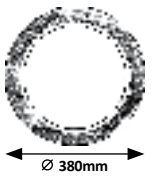

5407

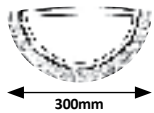

5427

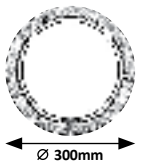

5427

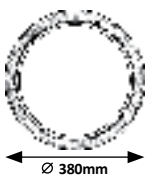

540I MWG

☒ E27 / 1x max. 60W
IP20 • 9105
natural/opal glass



5407 MWG

☒ E27 / 1x max. 60W
IP20 • 9105
oak/opal glass



542I MWG

☒ E27 / 1x max. 60W
IP20 • 9101
natural/opal glass



5427 MWG

☒ E27 / 1x max. 60W
IP20 • 9101
oak/opal glass



542I MWG

☒ E27 / 2x max. 60W
IP20 • 9103
natural/opal glass



5427 MWG

☒ E27 / 2x max. 60W
IP20 • 9103
oak/opal glass



UFO



5173

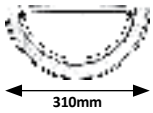

5143

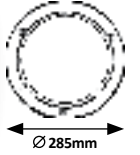

5143

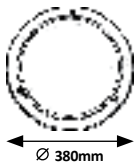

5181



5121

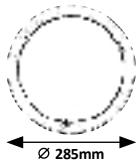

5151



5113

(M G)

☒ E27 / 1x max. 60W
IP20 • 9900
chrome/opal glass



5121

(M G)

☒ E27 / 1x max. 60W
IP20 • 9903
satin chrome/white



5143

(M G)

☒ E27 / 2x max. 60W
IP20 • 9103
chrome/opal glass



5151

(M G)

☒ E27 / 2x max. 60W
IP20 • 9200
satin chrome/white



5173

(M G)

☒ E27 / 1x max. 60W
IP20 • 9105
chrome/opal glass



5181

(M G)

☒ E27 / 1x max. 60W
IP20 • 9053
satin chrome/white



UFO



5263

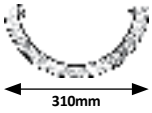

5203

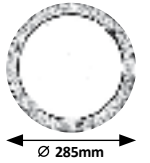

5233

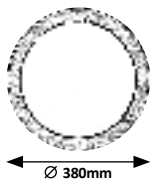

5163

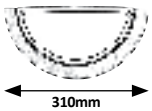

5103

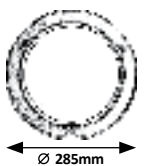

5203 **MG**

☒ E27 / 1x max. 60W
IP20 • 9903
bronze/white



5 362250 352370

5233 **MG**

☒ E27 / 2x max. 60W
IP20 • 9200
bronze/white



5 362250 352370

5263 **MG**

☒ E27 / 1x max. 60W
IP20 • 9053
bronze/white



5 362250 352370

5103 **MG**

☒ E27 / 1x max. 60W
IP20 • 9900
black/opal glass



5 362250 351232

5163 **MG**

☒ E27 / 1x max. 60W
IP20 • 9105
black/opal glass



5 362250 351232

UFO



DISKY

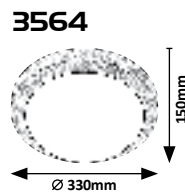
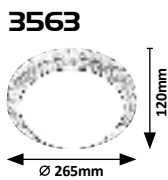

5101 **MG**

☒ E27 / 1x max. 60W
IP20 • 9900
white/opal glass



S 36R25C 351216

5131 **MG**

☒ E27 / 2x max. 60W
IP20 • 9103
white/opal glass



S 36R25C 351315

5161 **MG**

☒ E27 / 1x max. 60W
IP20 • 9105
white/opal glass



S 36R25C 351612

3563 **MG**

☒ E27 / 1x max. 40W
IP20 • 9565
bronze/opal glass



S 36R25C 335630

3564 **MG**

☒ E27 / 2x max. 40W
IP20 • 9551
bronze/opal glass

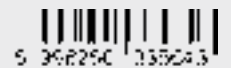

S 36R25C 335643

ALFONS



3050 **(M)**
 E27 / 1x max. 25W
 IP20 •
 white/gold



4504 **(M)**
 E27 / 1x max. 25W
 IP20 •
 black



EGON



5242

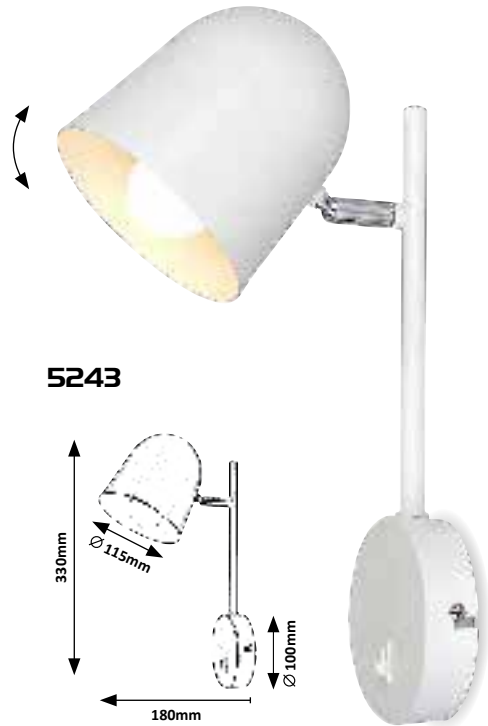

5243

MIKA



6719



6720

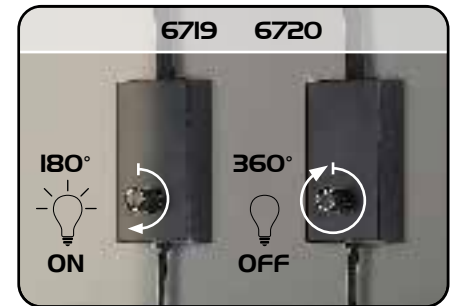

5242



☒ E14 / 1x max. 40W
IP20 • •
matte black



5 938253 372428

5243



☒ E14 / 1x max. 40W
IP20 • •
matte white



5 938253 372435

6719



☒ GU10 / 1x max. 25W
IP20 • •
black



5 938253 367194

6720



☒ GU10 / 1x max. 25W
IP20 • •
white



5 938253 367200



ANJA





5672

DOBRA





5673

5672 

 E14 / 1x max. 40W
IP20 • 
satin chrome



5673 

 LED 4,5W (340lm, 3000K) incl.
GU10 / 1x max. 35W
IP20 • 
white/chrome



LARKIN



6529

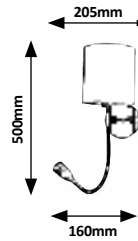

E27
1x max. 40W excl.



LED built-in
3W



HARVEY



6539

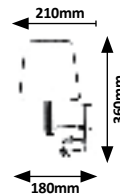

E27
1x max. 40W excl.

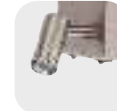

LED built-in
3W



6529 **M T**

☑ LED / 3W (205lm, 2800K) incl.
 ☒ E27 / 1x max. 40W
 IP20 • [] • [] 19416
 chrome/white



5 362250 365290

6539 **M T**

☑ LED / 3W (180lm, 2800K) incl.
 ☒ E27 / 1x max. 40W
 IP20 • [] • [] 19493
 satin chrome/white



5 362250 365390

FIXY

ROXY

TEXTILE
CABLE

TEXTILE
CABLE

I411

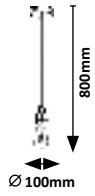

I418

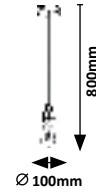

I417

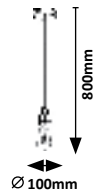

I412

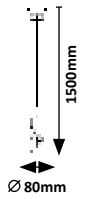

I418



I411

(M)

☒ E27 / 1x max. 60W
IP20
black



5 368250 314112

I417

(M)

☒ E27 / 1x max. 60W
IP20
bronze



5 368250 314117

I418

(M)

☒ E27 / 1x max. 60W
IP20
silver



5 368250 314118

I412

(S)

☒ E27 / 1x max. 60W
IP20
black



5 368250 314112

FIX



I331

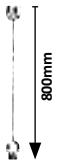

I338



9920



I332

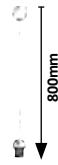

9919

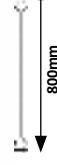

9926

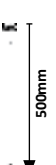

I331

(P)

☒ E27 / 1x max. 60W
IP20
chrome

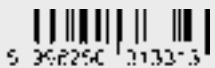

S 362250 213313

I332

(P)

☒ E27 / 1x max. 60W
IP20
transparent



S 362250 213320

I338

(M)

☒ E27 / 1x max. 60W
IP20
chrome



S 362250 213322

9919

(P)

☒ E27 / 1x max. 60W
IP20
white



S 362250 203190

9920

(P)

☒ E27 / 1x max. 60W
IP20
bronze



S 362250 203201

9926

(M)

☒ E27 / 1x max. 60W
IP20
satin chrome



S 362250 203203

9921

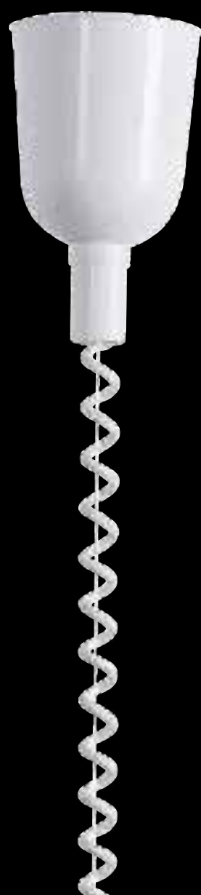

9923



MORRIS

5059

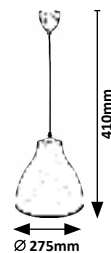

5060

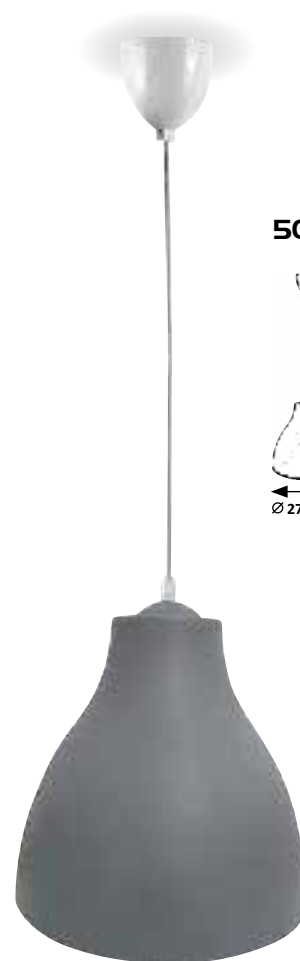
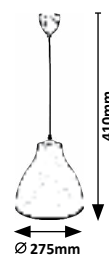

5059 (P)

☒ E27 / 1x max. 40W
IP20
white

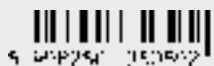

5060 (P)

☒ E27 / 1x max. 40W
IP20
grey/white



ROLLY



9921

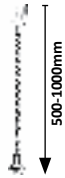

9923

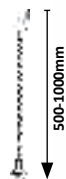

ROLLY PULL



1421

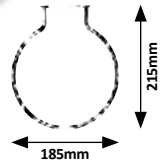

BOTTOM



1301

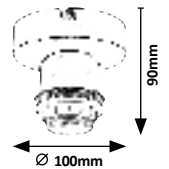

9921 (P)

☒ E27 / 1x max. 60W
IP20
white



S 36225C 103272

9923 (P)

☒ E27 / 1x max. 60W
IP20
bronze



S 36225C 103272

1421 (P)

white



S 36225C 114271

1301 (M)

☒ E27 / 1x max. 60W
IP20
chrome



S 36225C 113270

05

FLOOR AND TABLE LAMPS

ÁLLÓ- ÉS ASZTALI LÁMPÁK

STEH- UND TISCHLAMPEN



74004



RADER

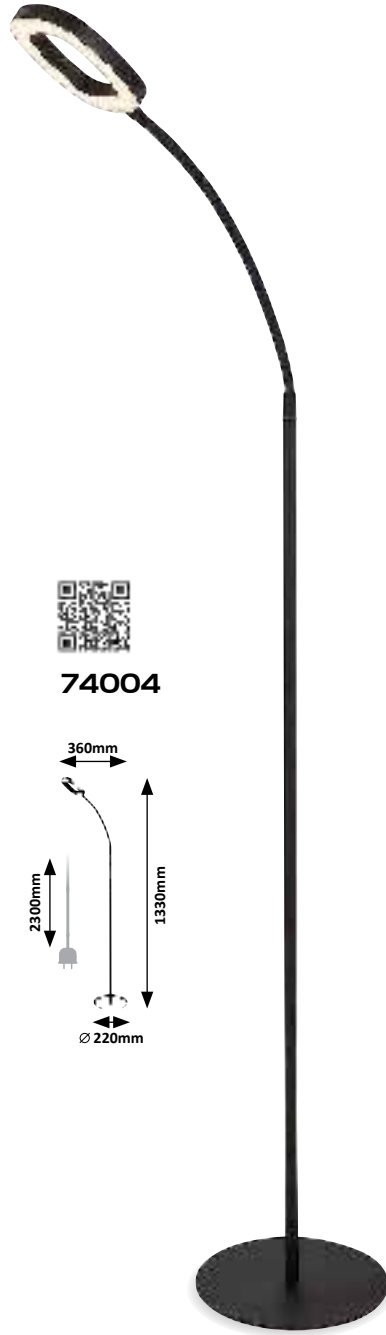

74004

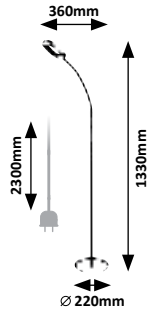

LUIGI

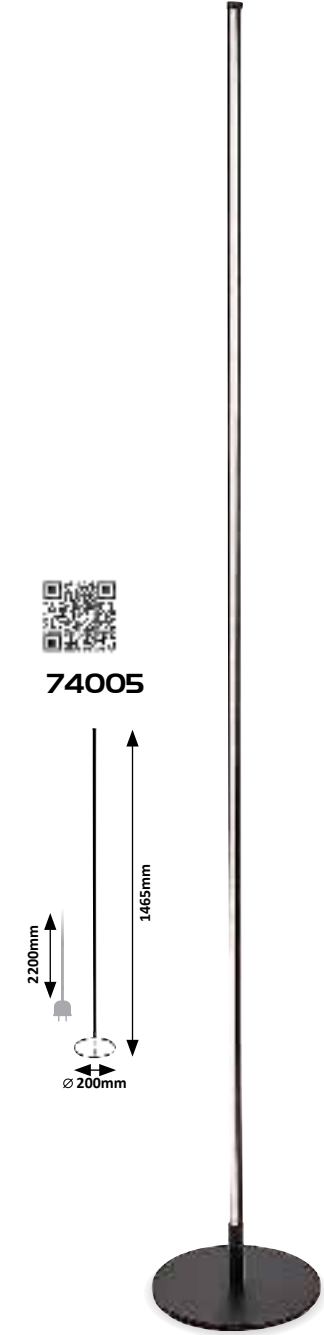
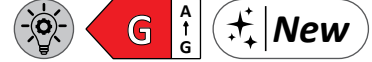

74005

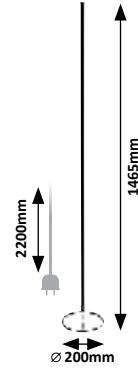

74004 (M) (P)

LED / 11W
(570lm, 930lm;
3000K) incl. • IP20
black/white



74005 (M) (P)

LED / 18W
(1050lm, 1930lm;
3000K) incl. • IP20 •
black/white



DRACO

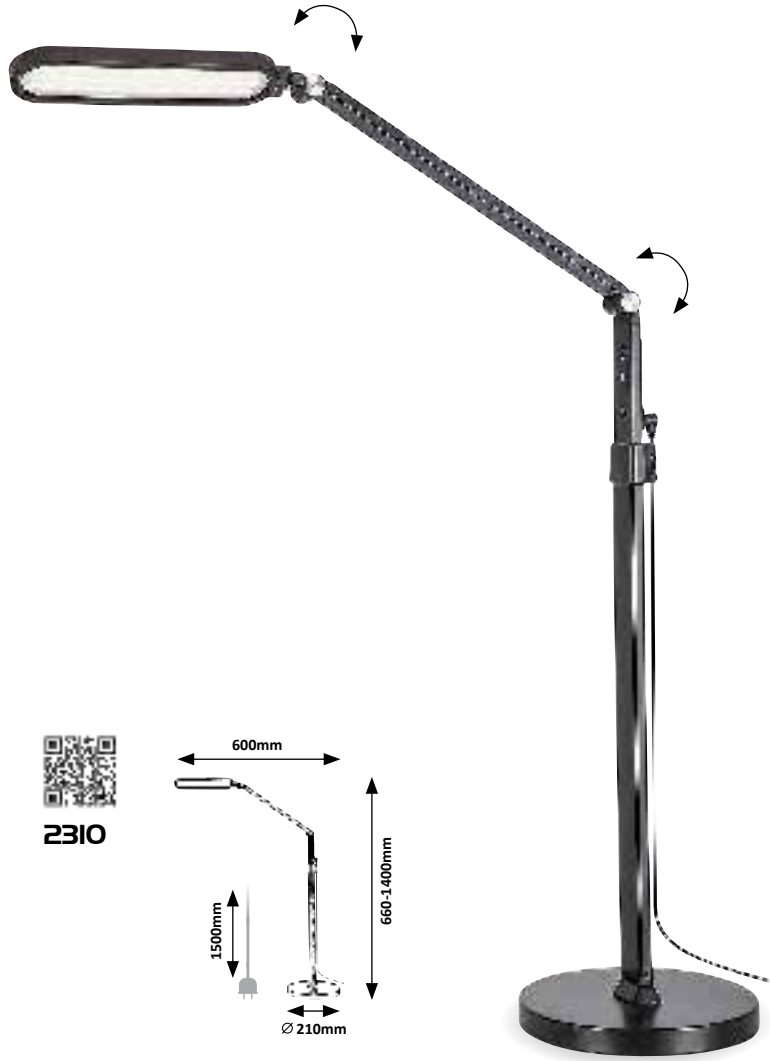

2310

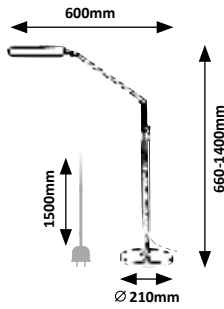

2310

M P

LED / 13W
(790lm; 1050lm, 3000K-6000K) incl.
IP20
black/white



5 908253 32307

2310



2in1



ADELMO



74007

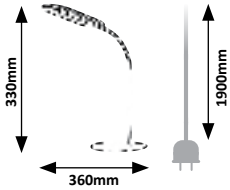

74008

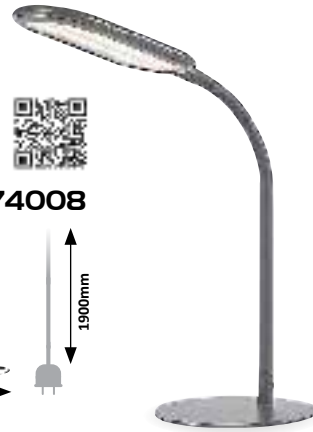
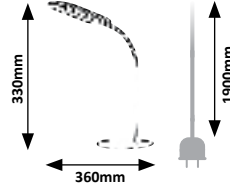

74009

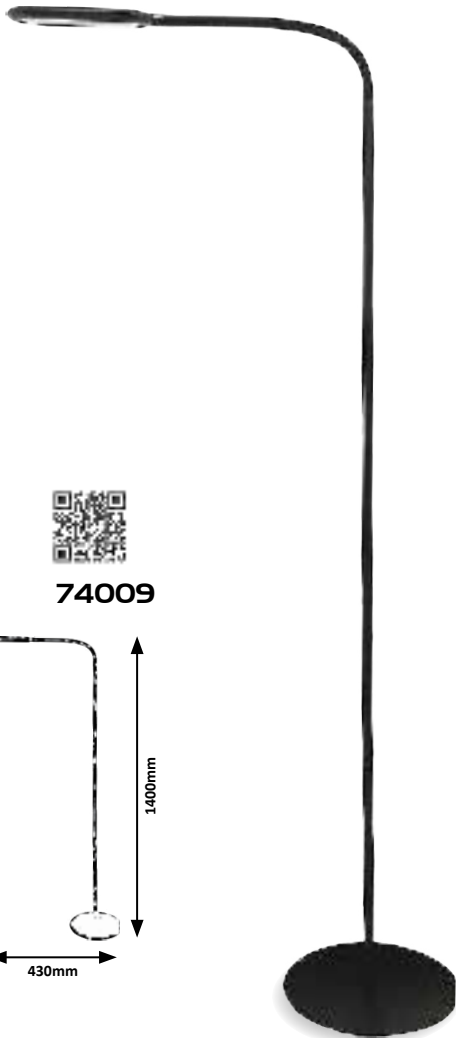
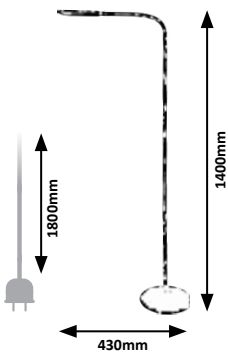

74010

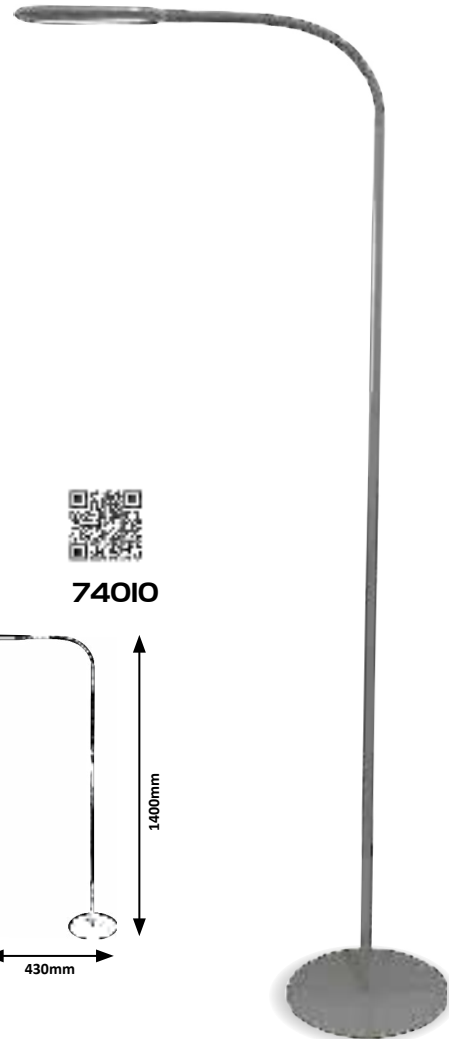
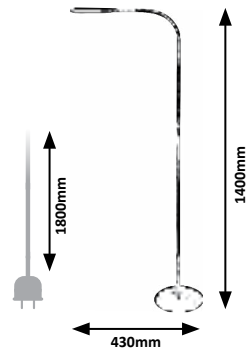

74007 (M) (P)

LED / 10W
(910lm, 1000lm;
3000K-6000K) incl. • IP20
black/white



74008 (M) (P)

LED / 10W
(910lm, 1000lm;
3000K-6000K) incl. • IP20
grey/white



74009 (M) (P)

LED / 10W
(910lm, 1000lm;
3000K-6000K) incl. • IP20
black/white



74010 (M) (P)

LED / 10W
(910lm, 1000lm;
3000K-6000K) incl. • IP20
grey/white



FLINT



3092

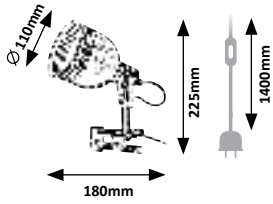

3093

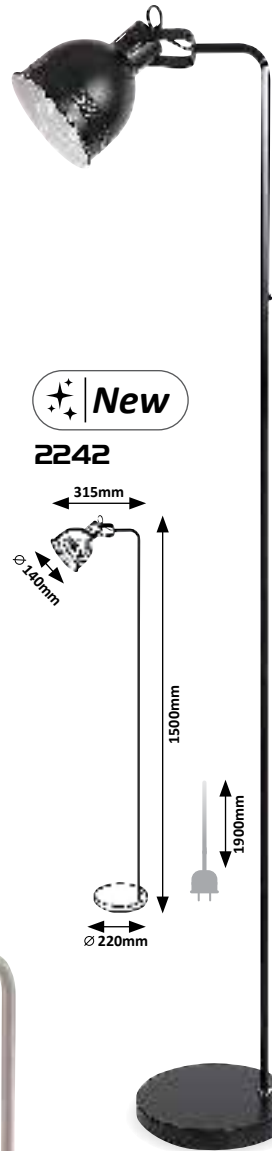
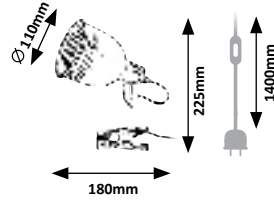

New

2242

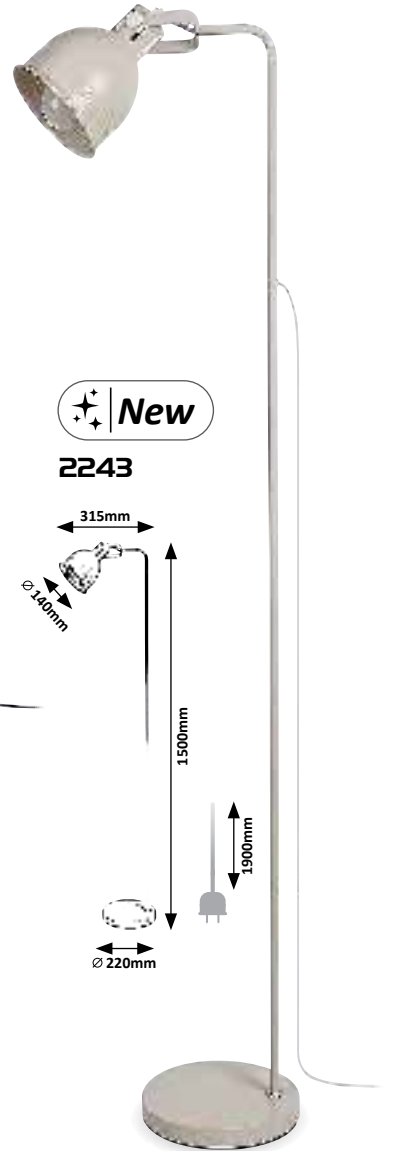
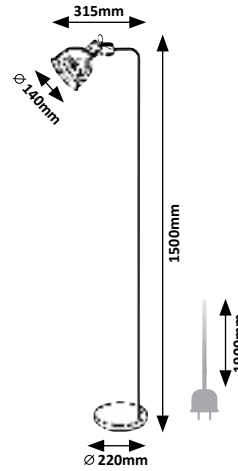

New

2243

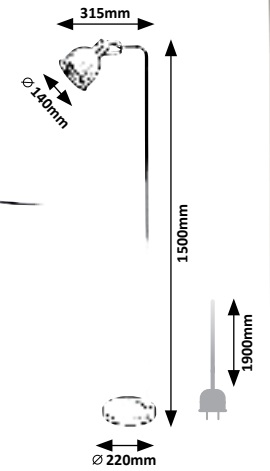

New

2240

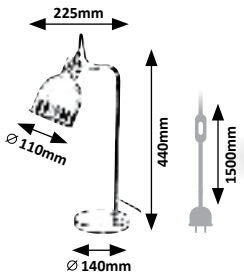

New

2241

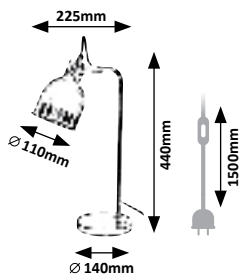

3092

(M)

☒ E14 / 1x max. 25W
IP20 • black/white



5 398250 322421

3093

(M)

☒ E14 / 1x max. 25W
IP20 • beige/white



5 398250 322422

2240

(M)

☒ E14 / 1x max. 25W
IP20 • black/white



5 038253 322407

2241

(M)

☒ E14 / 1x max. 25W
IP20 • beige/white



5 038253 322408

2242

(M)

☒ E27 / 1x max. 40W
IP20 • black/white



5 038253 322421

2243

(M)

☒ E27 / 1x max. 40W
IP20 • beige/white



5 038253 322422



DARON



5239 (M)

☒ E27 / 1x max. 40W
IP20 •
matte white



5240 (M)

☒ E27 / 1x max. 40W
IP20 •
matte black



5241 (M)

☒ E27 / 1x max. 40W
IP20 •
satin chrome



OTTO

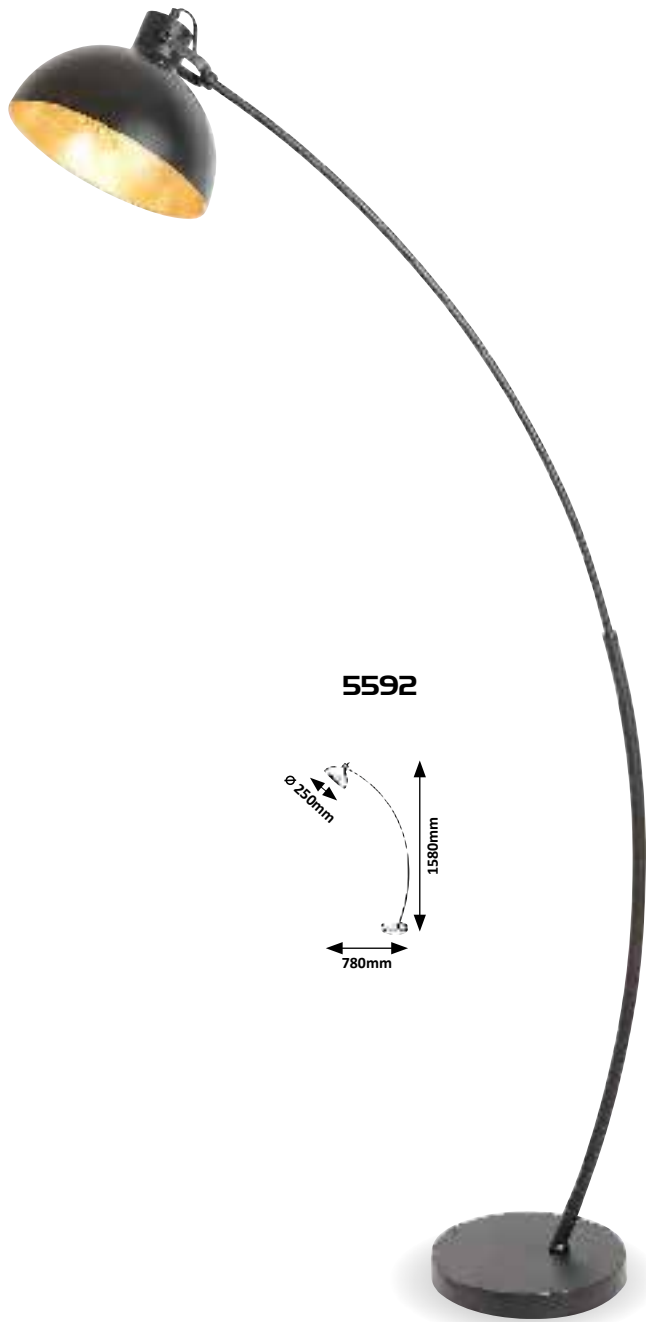

5592

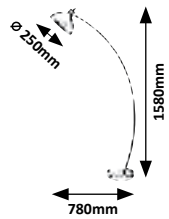

5592 (M)



☒ E27 / 1x max. 60W
IP20 • 
matte black/gold foil



ARISTEO

 **New**



2196 
☒ E27 / 1x max. 40W
IP20 • 
matte black/silver



9 058253 32167

2197 
☒ E27 / 1x max. 40W
IP20 • 
beige/gold



9 058253 321674

VLASTA

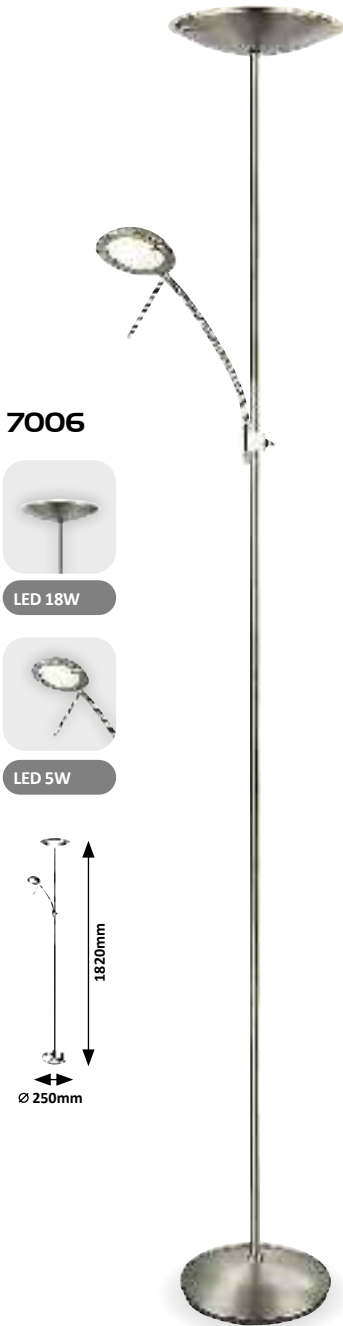

7006



LED 18W



LED 5W



OPHUS



3239



LED 18,5W



LED 4,5W

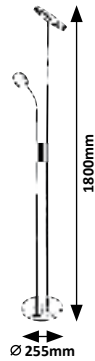

3240



LED 18,5W



LED 4,5W



3239, 3240



7006 **MP**

LED / 18W (1400lm, 3000K) + LED / 5W (400lm, 3000K) incl. IP20 • 19440 satin chrome



5 362250 375004

3239 **MG**

LED / 18,5W (2110lm, 3000K) incl. + LED / 4,5W (360lm, 3000K) incl. IP20 • 19897 • 19898 • satin chrome/transparent



5 362250 332390

3240 **MG**

LED / 18,5W (2110lm, 3000K) incl. + LED / 4,5W (360lm, 3000K) incl. IP20 • 19897 • 19898 • matte black/transparent



5 362250 332400

BETA



4075



R7s
1x max. 230W



G9
1x max. 40W

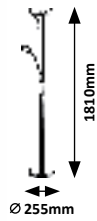

4076

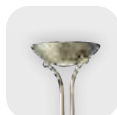

R7s
1x max. 230W

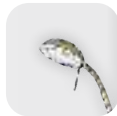

G9
1x max. 40W

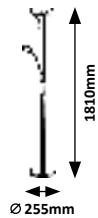

GAMMA TREND



4554

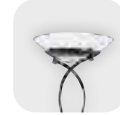

E27
2x max. 15W

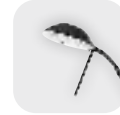

G9
1x max. 40W

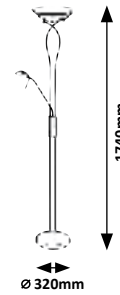

4555

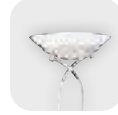

E27
2x max. 15W

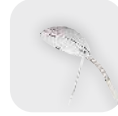

G9
1x max. 40W

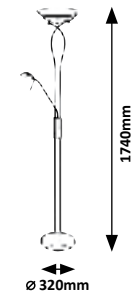

4075 **MG**

☑ 230W (4970lm, 2700K)
+ 28W (370lm, 2700K) incl.
R7s / 1x max. 230W + G9 / 1x max. 40W
IP20 • ☐ • ▲ 19004 • satin chrome



5 362250 343713

4076 **MG**

☑ 230W (4970lm, 2700K)
+ 28W (370lm, 2700K) incl.
R7s / 1x max. 230W + G9 / 1x max. 40W
IP20 • ☐ • ▲ 19004 • bronze



5 362250 343700

4554 **MG**

☒ E27 / 2x max. 15W
+ G9 / 1x max. 40W
IP20 • ☐ • ▲ 19002 • ▲ 19003
matte black/white



5 362250 343543

4555 **MG**

☒ E27 / 2x max. 15W
+ G9 / 1x max. 40W
IP20 • ☐ • ▲ 19002 • ▲ 19003
antique white/white



5 362250 343500

GAMMA



4077



R7s
1x max. 230W



G9
1x max. 40W

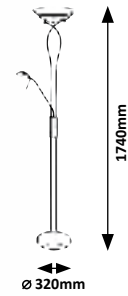

4078

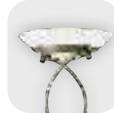

R7s
1x max. 230W



G9
1x max. 40W

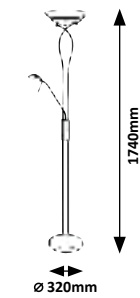

4077 **MG**

☑ 230W (4970lm, 2700K) + 28W (370lm, 2700K) incl.
R7s / 1x max. 230W + G9 / 1x max. 40W
IP20 • • 19002 • 19003
satin chrome/white



5 362250 340777

4078 **MG**

☑ 230W (4970lm, 2700K) + 28W (370lm, 2700K) incl.
R7s / 1x max. 230W + G9 / 1x max. 40W
IP20 • • 19002 • 19003
bronze/white



5 362250 340784

— PEARL CLASSIC —

— HARMONY —

 Others / Best match



4019



4091



5739

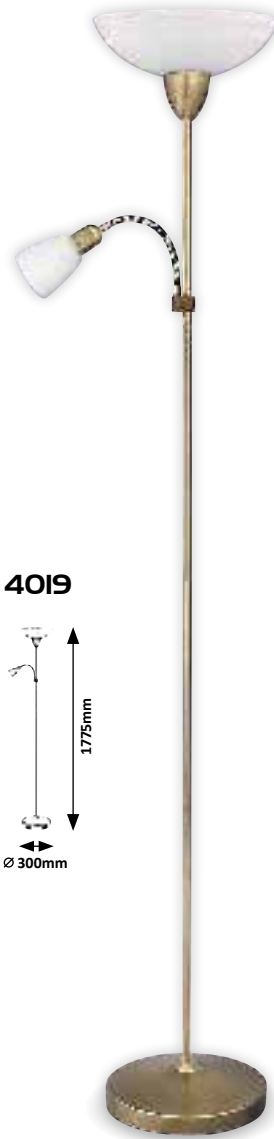



4019

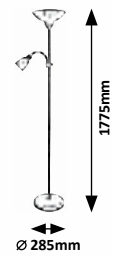

4091



4019 **MG**

☒ E27 / G45 / 1x max. 60W +
E14 / 1x max. 40W
IP20 •  9584 •  9585
bronze/alabaster



4091 **MG**

☒ E27 / 1x max. 100W +
E14 / 1x max. 40W
IP20 •  19005 •  19006
satin chrome/white/grey



DIANA

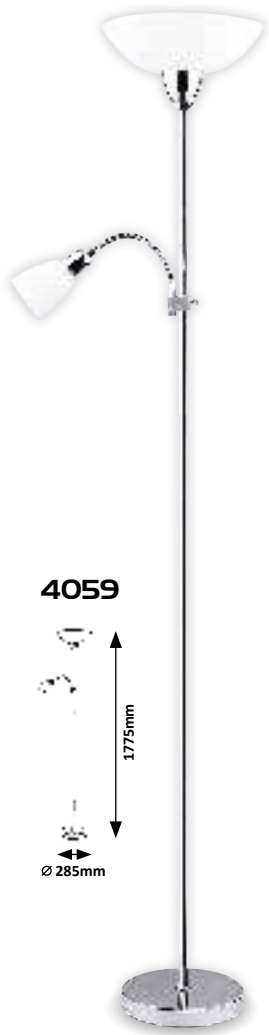

4059

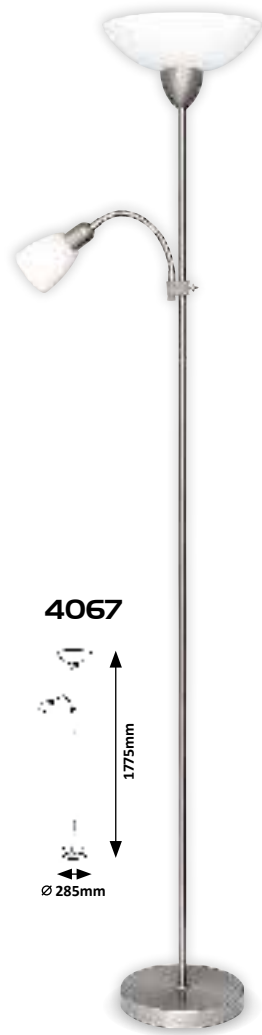
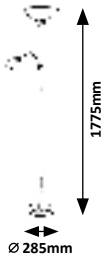

4067

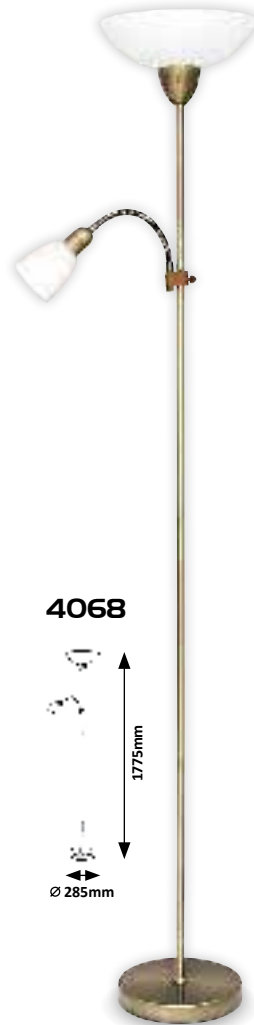
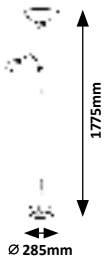

4068

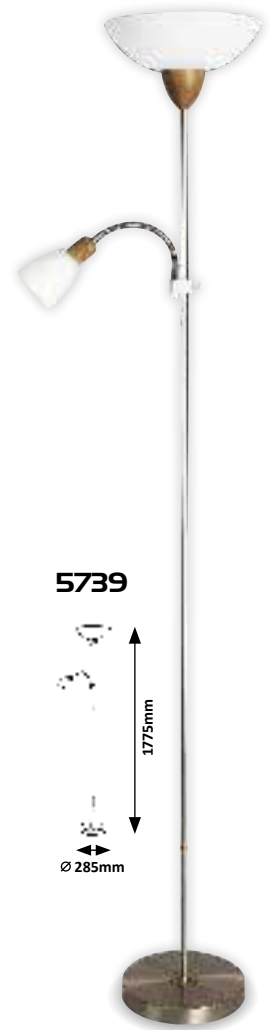
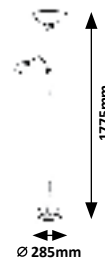

5739

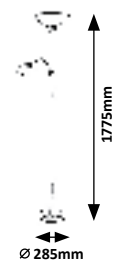

4059 MGP

☒ E27 / G45 / 1x max. 60W +
E14 / 1x max. 40W
IP20 • ☐ • ▲ 9867 • ▼ 9868
chrome/white



S 36R25C 340593

4067 MGP

☒ E27 / G45 / 1x max. 60W +
E14 / 1x max. 40W
IP20 • ☐ • ▲ 9867 • ▼ 9868
satin chrome/white



S 36R25C 340678

4068 MGP

☒ E27 / G45 / 1x max. 60W +
E14 / 1x max. 40W
IP20 • ☐ • ▲ 9867 • ▼ 9868
bronze/white



S 36R25C 340685

5739 MGP

☒ E27 / G45 / 1x max. 40W +
E14 / 1x max. 40W
IP20 • ☐ • ▲ 9867 • ▼ 9868
satin chrome/beechno/white



S 36R25C 357393

ACTION

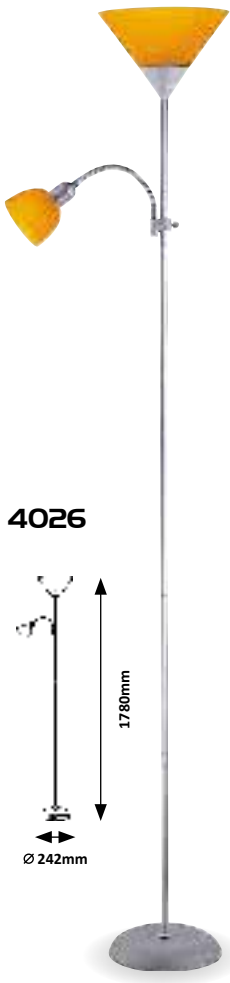

4026

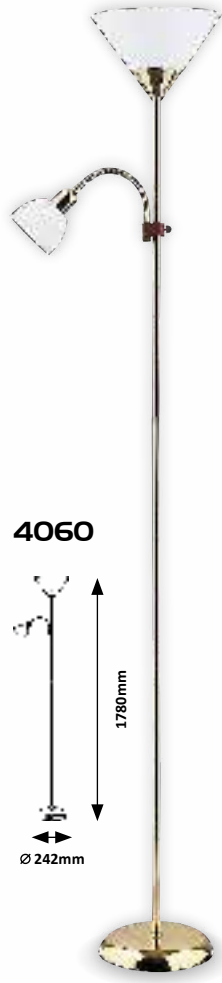
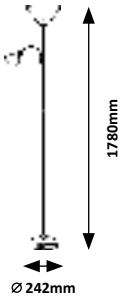

4060

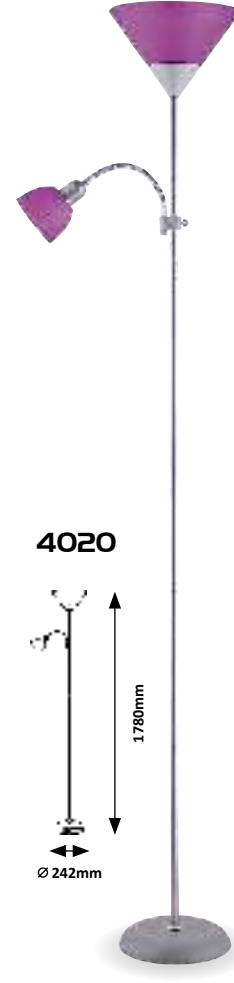
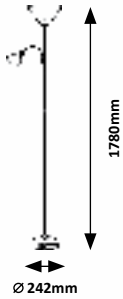

4020

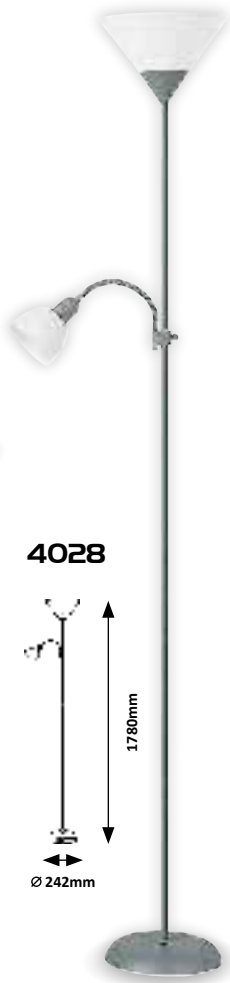
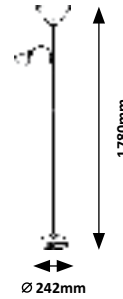

4028

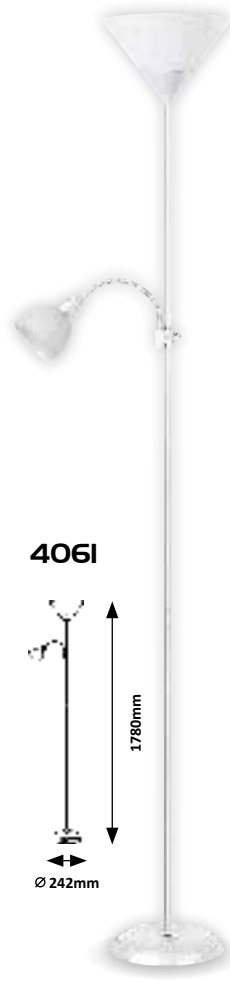
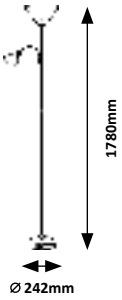

4061

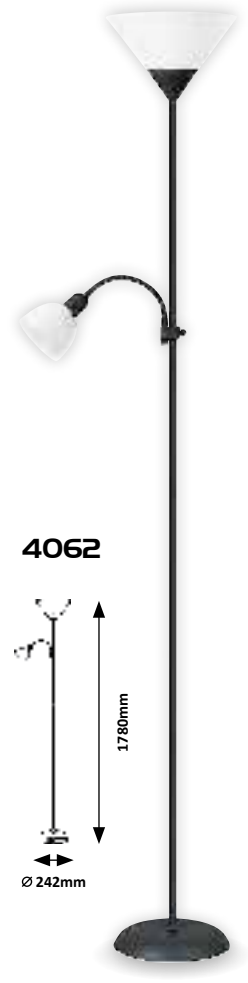
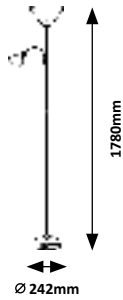

4062

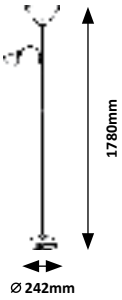

4026 (MP)

☒ E27 / 1x max. 100W +
E14 / 1x max. 25W
▣ 9808 • ▣ 9809
IP20 • ☒ • silver/orange



4028 (MP)

☒ E27 / 1x max. 100W +
E14 / 1x max. 25W
▣ 9871 • ▣ 9872
IP20 • ☒ • silver/white



4060 (MP)

☒ E27 / 1x max. 100W +
E14 / 1x max. 25W
▣ 9871 • ▣ 9872
IP20 • ☒ • gold/white



4061 (MP)

☒ E27 / 1x max. 100W +
E14 / 1x max. 25W
▣ 9871 • ▣ 9872
IP20 • ☒ • white



4020 (MP)

☒ E27 / 1x max. 100W +
E14 / 1x max. 25W
▣ 19199 • ▣ 19200
IP20 • ☒ • silver/purple



4062 (MP)

☒ E27 / 1x max. 100W +
E14 / 1x max. 25W
▣ 9871 • ▣ 9872
IP20 • ☒ • black/white



ACTION

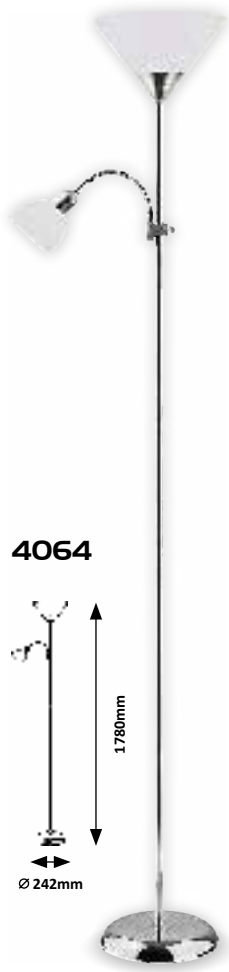

4064

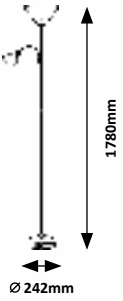

4065

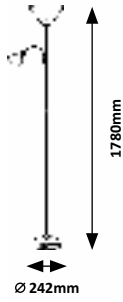

4188

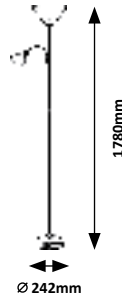

4064 (M) (P)

☒ E27 / 1x max. 100W +
E14 / 1x max. 25W
▲ 9871 • ▽ 9872
IP20 • ☒ • satin chrome/white



S 36R25C 149247

4065 (M) (P)

☒ E27 / 1x max. 100W +
E14 / 1x max. 25W
▲ 9871 • ▽ 9872
IP20 • ☒ • bronze/white



S 36R25C 149248

4188 (M) (P)

☒ E27 / 1x max. 100W +
E14 / 1x max. 25W
▲ 9871 • ▽ 9872
IP20 • ☒ • brown/white



S 36R25C 141830

IZANDER

New

GODRIC

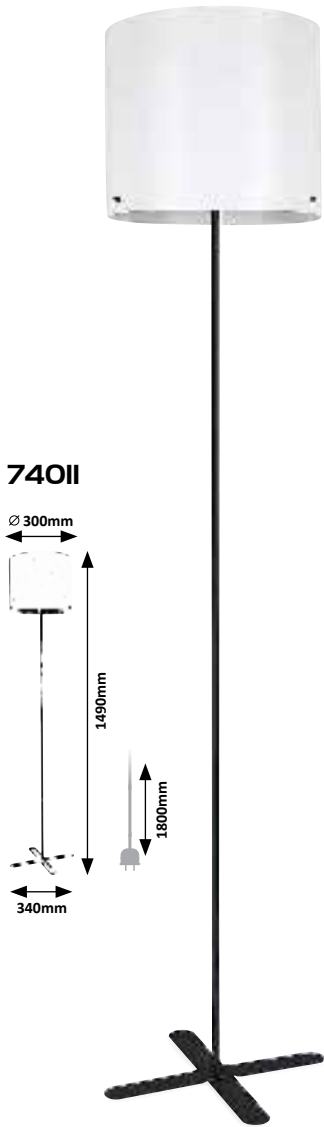

740I1

∅ 300mm

1490mm

1800mm

340mm

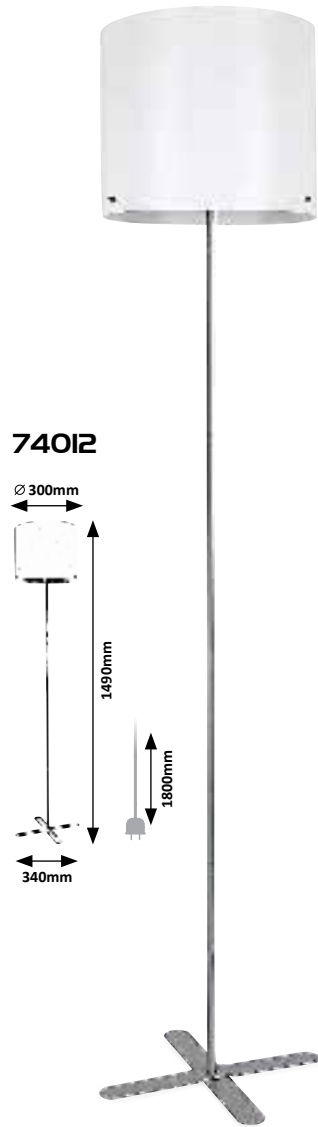

740I2

∅ 300mm

1490mm

1800mm

340mm

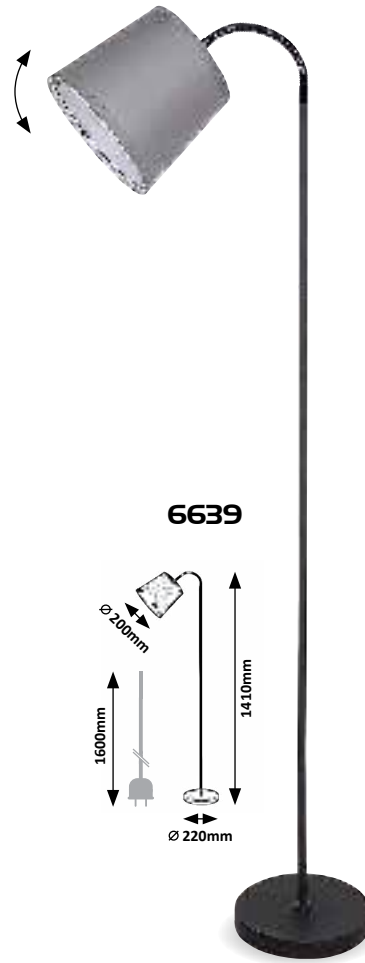

6639

∅ 200mm

1600mm

1410mm

∅ 220mm

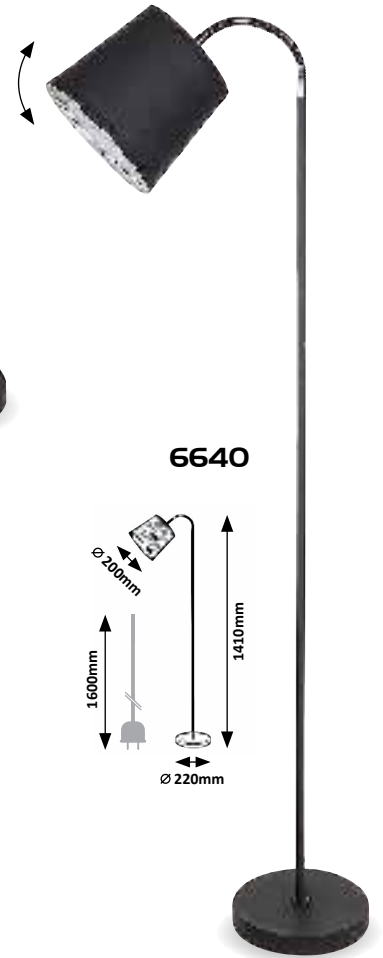

6640

∅ 200mm

1600mm

1410mm

∅ 220mm

740I1 (M) (P)

☒ E27 / 1x max. 40W
IP20 • 19369 • black/white



5 392290 060395

740I2 (M) (P)

☒ E27 / 1x max. 40W
IP20 • 19369 • silver/white



5 392290 060395

6639 (M) (T)

☒ E27 / 1x max. 25W
IP20 •
19982
black/grey



5 392290 060395

6640 (M) (T)

☒ E27 / 1x max. 25W
IP20 •
19979
black



5 392290 060401

AZIM

New

WOOD TEXTILE CABLE

THOMAS

WOOD **New**

LYCHEE

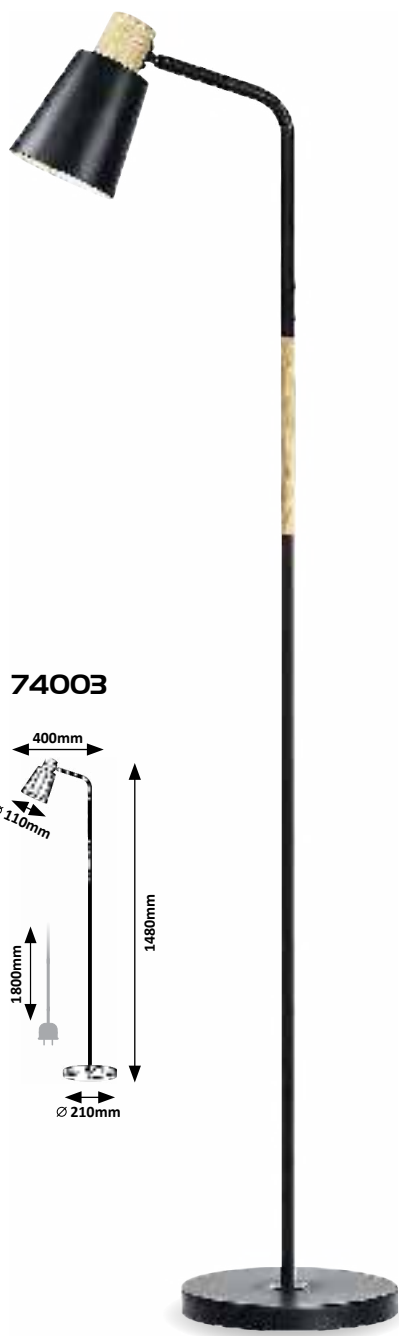

74003

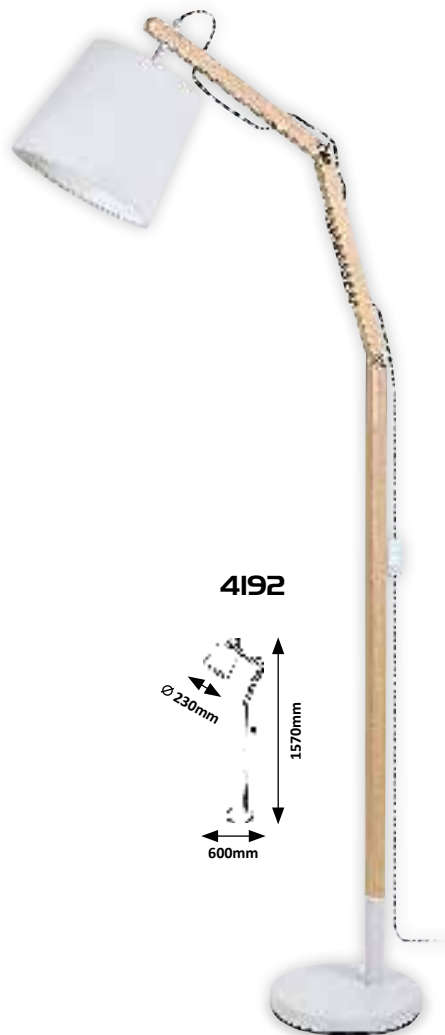
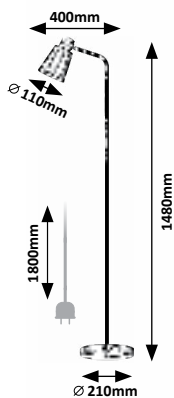

4192

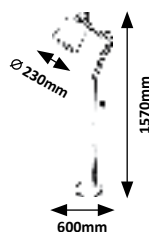

2068

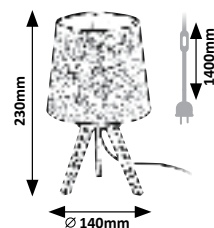

2069

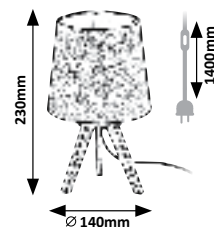

74003

☒ E27 / 1x max. 40W
IP20 •
black



5 4176794 740030

4192

☒ E27 / 1x max. 60W
IP20 •
 19455
beech/white



5 362250 419227

2068

☒ E14 / 1x max. 25W
IP20 •
 19822
beech/natural



5 038253 206837

2069

☒ E14 / 1x max. 25W
IP20 •
 19823
beech/black



5 038253 206934

ANAIS



5469

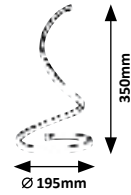

2774

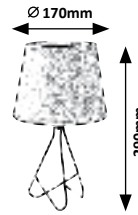

2775

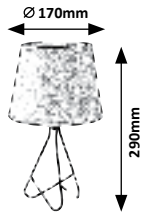

KINGA



5470

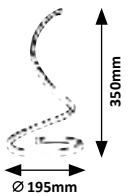

3016

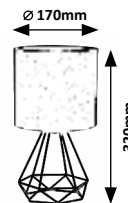

3017

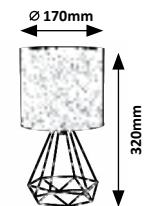

5469

(M P)

LED / 4,8W
(200lm, 4000K) incl.
IP20 • □
silver



5470

(M P)

LED / 4,8W
(200lm, 4000K) incl.
IP20 • □
gold



2774

(M T)

☒ E14 / 1x max. 40W
IP20 • □
19892
black/rose gold

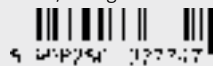

2775

(M T)

☒ E14 / 1x max. 40W
IP20 • □
19893
grey/chrome



3016

(M T)

☒ E14 / 1x max. 40W
IP20 • □
19655
black



3017

(M T)

☒ E14 / 1x max. 40W
IP20 • □
19656
brown/gold



SONAL



4548

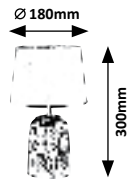

4549

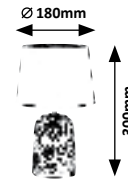

EVELYN



4372

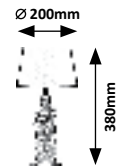

SALEM



4948

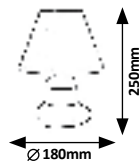

4949

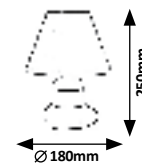

4950

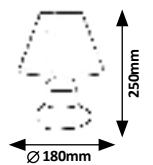

4548 (C T)

⊗ E14 / 1x max. 40W
IP20 • □
19807
silver/white

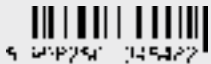

4549 (C T)

⊗ E14 / 1x max. 40W
IP20 • □
19808
gold/black



4372 (C T)

⊗ E14 / 1x max. 40W
IP20 • □
19383
chrome/black



4948 (C T)

⊗ E14 / 1x max. 40W
IP20 • □
19165
white/grey



4949 (C T)

⊗ E14 / 1x max. 40W
IP20 • □
19157
white/silver



4950 (C T)

⊗ E14 / 1x max. 40W
IP20 • □
19160
black/silver



MOLLY



4391

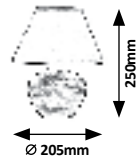

4392

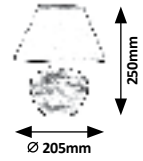

ORLANDO



4458

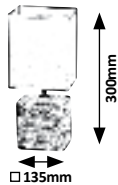

4928

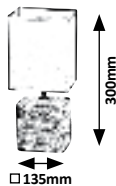

4929

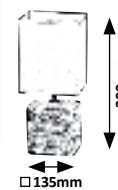

4930

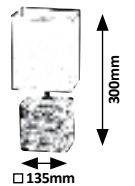

4391 (C T)

⊗ E14 / 1x max. 40W
IP20 •
19470
beige/white



S 36R25C 0433214

4392 (C T)

⊗ E14 / 1x max. 40W
IP20 •
19470
blue/white



S 36R25C 0433221

4458 (C T)

⊗ E14 / 1x max. 40W
IP20 •
19424
grey



S 36R25C 0445244

4928 (C T)

⊗ E14 / 1x max. 40W
IP20 •
19164
wenge/white



S 36R25C 0432282

4929 (C T)

⊗ E14 / 1x max. 40W
IP20 •
19164
cream/white



S 36R25C 0432290

4930 (C T)

⊗ E14 / 1x max. 40W
IP20 •
19164
cocoa/white



S 36R25C 0433005

ELLIE



4379

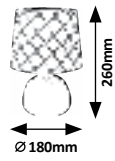

4380

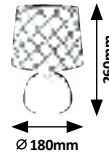

4384

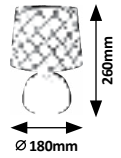

4379 (C) (T)

☒ E14 / 1x max. 40W
 IP20 •
 19458
 white



4380 (C) (T)

☒ E14 / 1x max. 40W
 IP20 •
 19459
 beige



4384 (C) (T)



☒ E14 / 1x max. 40W
 IP20 •
 19463
 rose



INGRID



4475 (C) (T)

☒ E14 / 1x max. 40W
IP20 • 
 19534
cream





4476 (C) (T)

☒ E14 / 1x max. 40W
IP20 • 
 19605
brown





4477 (C) (T)

☒ E14 / 1x max. 40W
IP20 • 
 19535
green



4478 (C) (T)

☒ E14 / 1x max. 40W
IP20 • 
 19536
claret



ARIEL



✦ ✦ **New**

2145

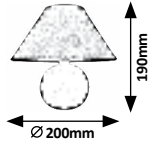

✦ ✦ **New**

2146

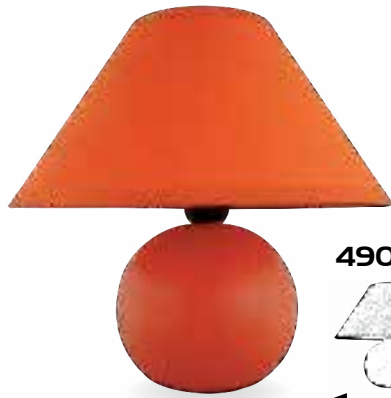
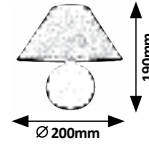

4904

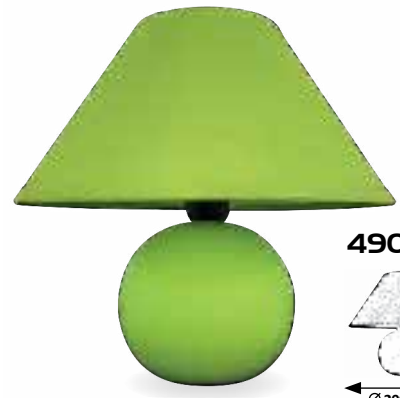
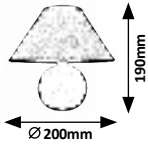

4907

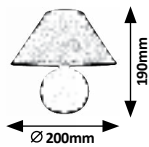

4901

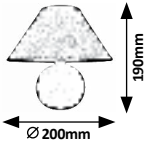

4906

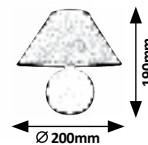

2145 C T

☒ E14 / 1x max. 40W
IP20
19824
rose



2146 C T

☒ E14 / 1x max. 40W
IP20
19853
grey



4901 C T

☒ E14 / 1x max. 40W
IP20 • ☐
9910
matte white



4904 C T

☒ E14 / 1x max. 40W
IP20 • ☐
9912
orange



4906 C T

☒ E14 / 1x max. 40W
IP20 • ☐
9914
cherry



4907 C T

☒ E14 / 1x max. 40W
IP20 • ☐
9915
green



WENDY



5220

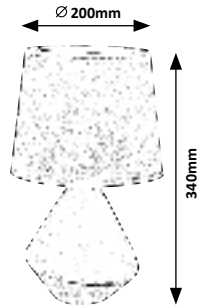

5221

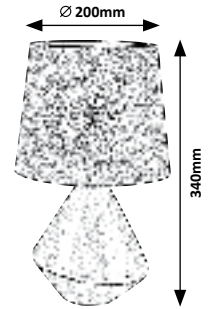

NALANI

VELVET



105. Others / Best match



2694

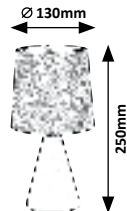

2695

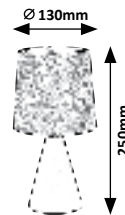

2696

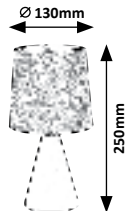

5220 **CT**

☒ E14 / 1x max. 40W
IP20 • • • 19941
grey



5221 **CT**

☒ E14 / 1x max. 40W
IP20 • • • 19942
brown



2694 **CT**

☒ E14 / 1x max. 40W
IP20 • • • 19899
beige



2695 **CT**

☒ E14 / 1x max. 40W
IP20 • • • 19900
grey



2696 **CT**

☒ E14 / 1x max. 40W
IP20 • • • 19901
blue



DORA

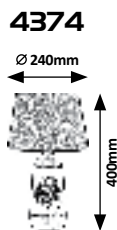

DORKA

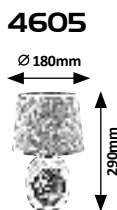

PETRA



SOPHIE

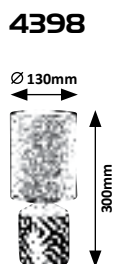

4374 (C) (T)

☒ E27 / 1x max. 40W
IP20 • □
19384
white/grey



S 398290 043747

4605 (C) (T)

☒ E14 / 1x max. 40W
IP20 • □
19550
brown



S 398290 046052

4386 (C) (T)

☒ E14 / 1x max. 40W
IP20 • □
19465
beige/grey



S 398290 043860

4398 (C) (T)

☒ E14 / 1x max. 40W
IP20 • □
19547
white/black



S 398290 043983

76007, 76010, 76013



Indoor • Beltér • Innen

2in1



Outdoor • Kültér • Außen

BANK



4037

4038

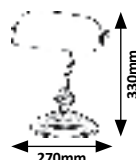
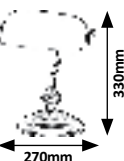

HORUS



2934

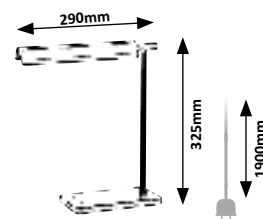

2934 (M) (P)

LED / 7W (530lm);
750lm, 3000K, 4000K, 6500K) incl.
IP20
black



4037 (M) (G)

E27 / 1x max. 60W
IP20 •
9586
satin chrome/white



4038 (M) (G)

E27 / 1x max. 60W
IP20 •
9587
bronze/green



TAENA

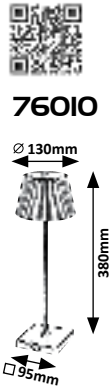
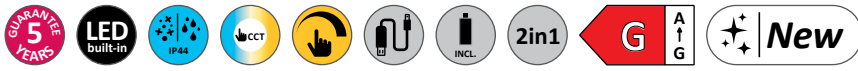

76010

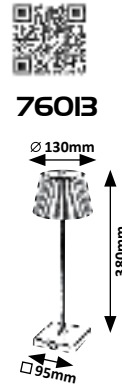

76013

ISHTAR

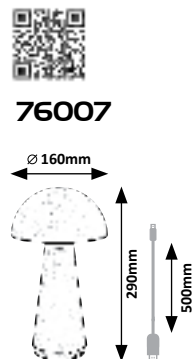
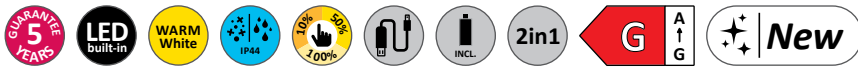

76007

76010, 76013



76010 (M) (P)

LED / 4W (200lm, 330lm; 3000K-5000K) incl.
DC 3,7V 1800mAh incl. • IP44
black/white



76013 (M) (P)

LED / 4W (200lm, 330lm; 3000K-5000K) incl.
DC 3,7V 1800mAh incl. • IP44
silver/white



76007 (P)

LED / 3W (130lm, 300lm; 3000K) incl.
DC 3,7V 2000mAh incl. • IP44
matte black





GREMIO



6915

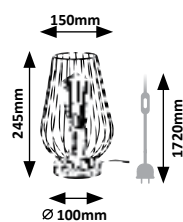

BOOGIE

3180

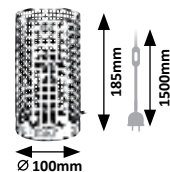

3179

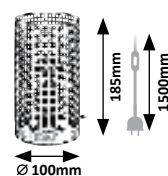

BRUNO

WOOD

New



2090

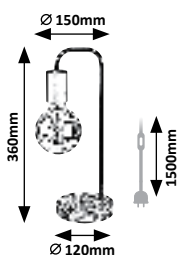

RUFIN



3219

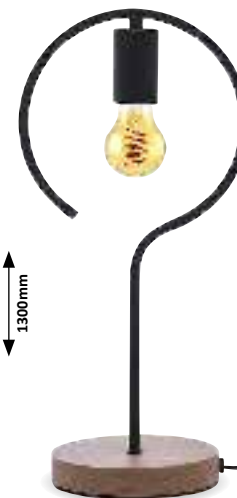
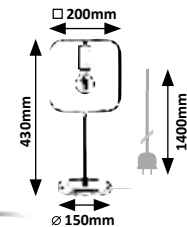

3220

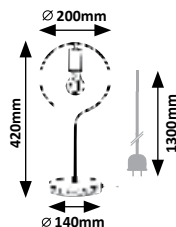

6915 (M) (W)

☒ E27 / 1x max. 40W
IP20 • beech/black



5 362250 363110

3179 (M)

☒ E14 / 1x max. 25W
IP20 • gold/white



5 362250 337790

3180 (M)

☒ E14 / 1x max. 25W
IP20 • beech/black



5 362250 337800

2090 (M) (W)

☒ E27 / 1x max. 40W
IP20 • black/beech



5 038253 300000

3219 (M)

☒ E27 / 1x max. 40W
IP20 • beech/black



5 362250 332792

3220 (M)

☒ E27 / 1x max. 40W
IP20 • beech/black



5 362250 332800

BOWIE

Others / Best match



LYDIA

30% 80% 100%
New
2070



6569 (M)
E27 / 1x max. 60W
IP20 •
black



5 398296 065293

6570 (M)
E27 / 1x max. 60W
IP20 •
white



5 398296 065701

2295 (M G)
E14 / 1x max. 40W
IP20
19777
silver/white



5 008253 022957

2296 (M G)
E14 / 1x max. 40W
IP20
19777
matte black/white



5 008253 022964



RONNIE

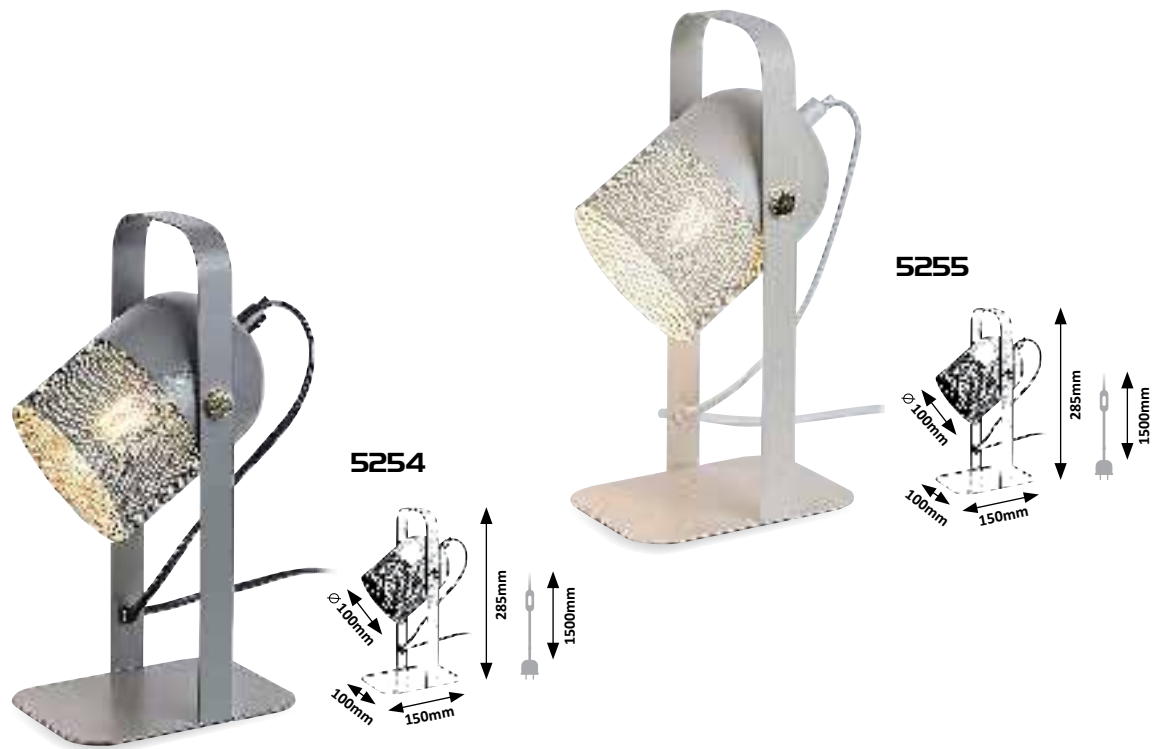

FANNY



5254 (M)

☒ E14 / 1x max. 25W
IP20 • grey/gold



5 392290 352541

5255 (M)

☒ E14 / 1x max. 25W
IP20 • beige/gold



5 392290 352551

3181 (M)

☒ E14 / 1x max. 25W
IP20 • black/gold



5 392290 331812

3182 (M)

☒ E14 / 1x max. 25W
IP20 • grey/rose gold



5 392290 331820

MONTY

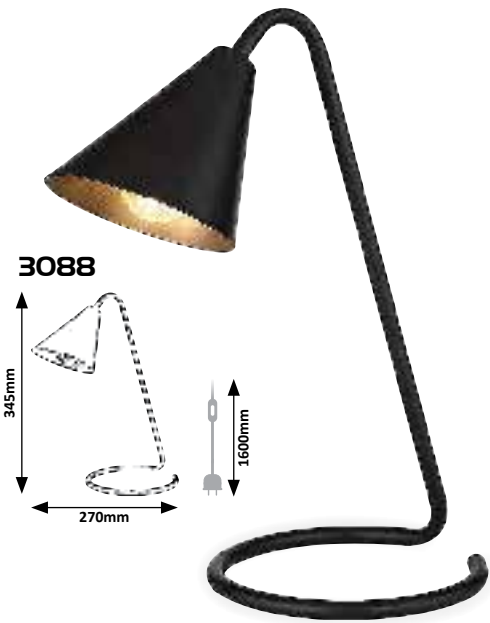

74001



MOSLEY

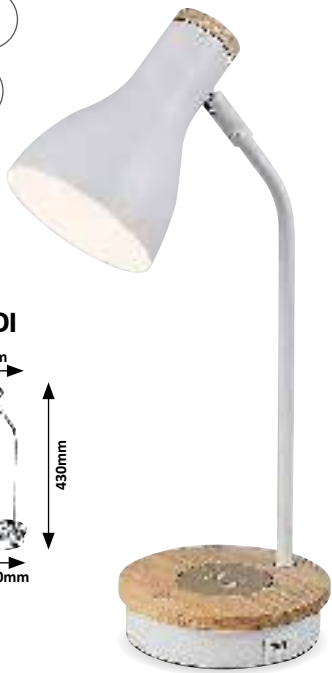

FERB



3088 (M)
 ☒ E14 / 1x max. 40W
 IP20 • ☐
 black



3089 (M)
 ☒ E14 / 1x max. 40W
 IP20 • ☐
 white



74001 (M)(W)
 ☒ E14 / 1x max. 25W
 IP20
 matte white



74002 (M)(W)
 ☒ E14 / 1x max. 25W
 IP20
 matte black



2029



NILFGARD



New

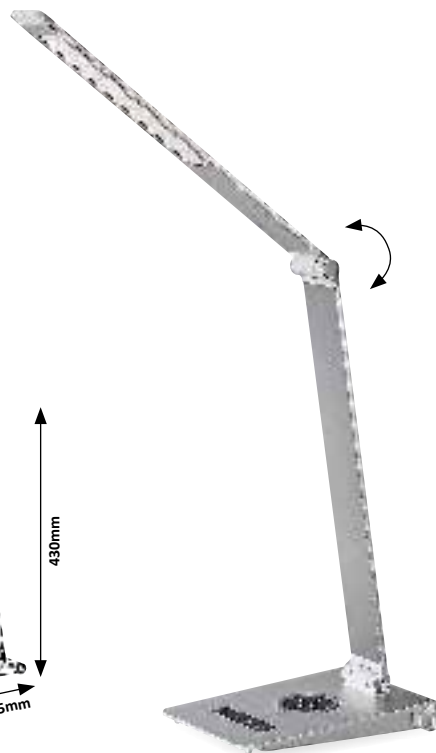

2029

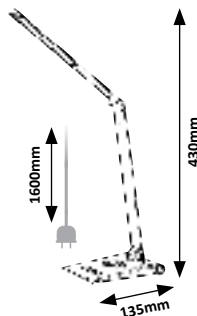

BULDUS



76005

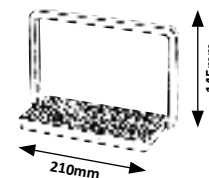

2029 (M) (P)

LED / 13W
(8) 890lm; (8) 1200lm, 2800K-5000K incl.
IP20
silver/white



5 908253 320259

76005 (P)

LED / 4W
(8) 160lm, (8) 930lm;
3000K incl. • IP20
oak/matte white



5 908253 760057

HARDIN

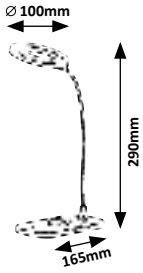
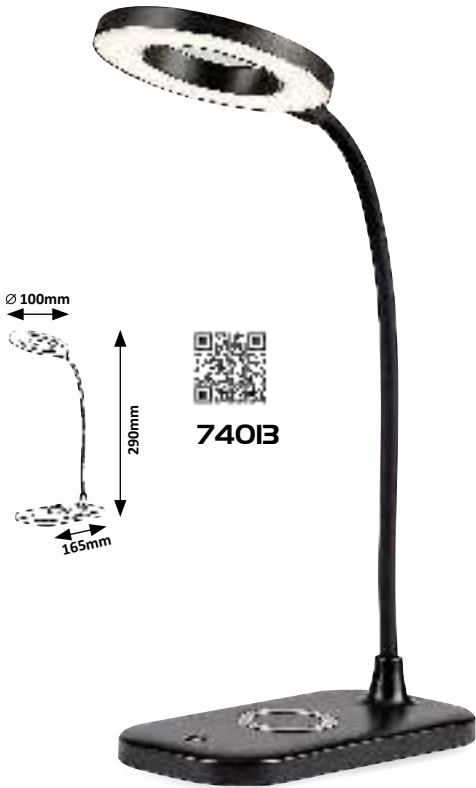

740B

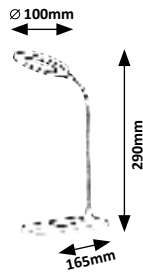
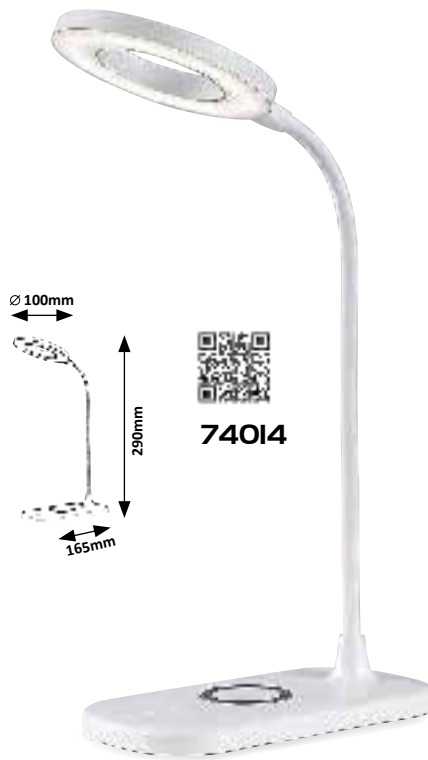

740I4

740B



LED / 5W
 (210lm, 720lm;
 2700K-6000K) incl. • IP20
 black/white



4 762 96 74 71 79

740I4



LED / 5W
 (210lm, 720lm;
 2700K-6000K) incl. • IP20
 white



4 762 96 74 71 79

76005



74015



DESHAL



74015

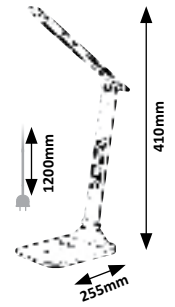

BALOR



3958

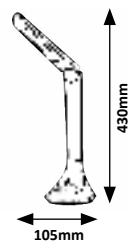

74015 (P)

LED / 5W
(300lm, 400lm;
3000K-6000K) incl. • IP20
white



3958 (P)

LED / 5W
(320lm, 4000K) incl.
IP20 • black/white



JUSTIN

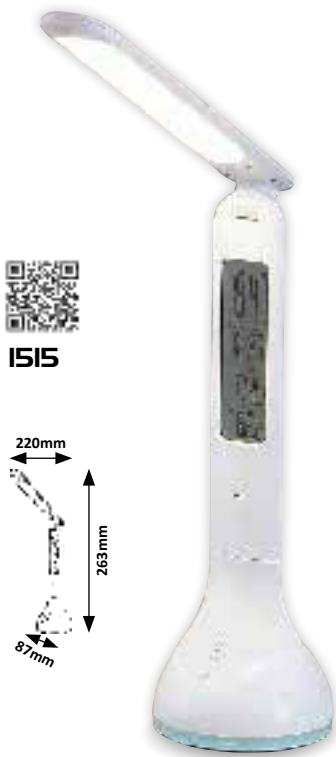

1515

LIONEL

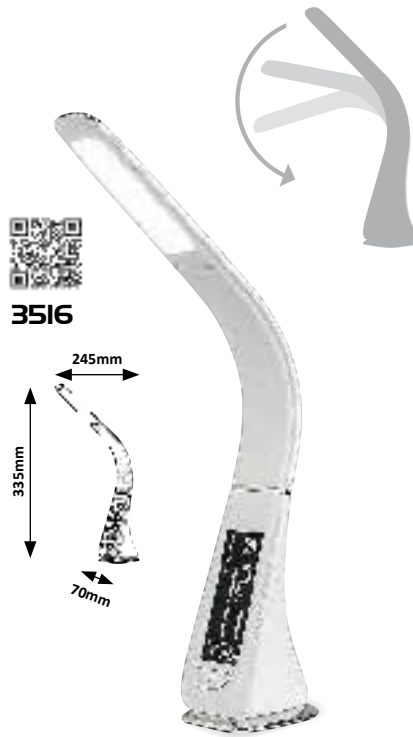

3516



3517

1515



1515



LED / 4W
(253lm, 4000K) incl.
IP20 • DC 5V incl. • •
white



5 362250 313177

3516



LED / 5W
(260lm, 5000K) incl.
IP20 • 5V/1A (DC) incl. • •
white



5 362250 335102

3517



LED / 5W
(260lm, 5000K) incl.
IP20 • 5V/1A (DC) incl. • •
black



5 362250 335109

5429



DOMINIC



4164

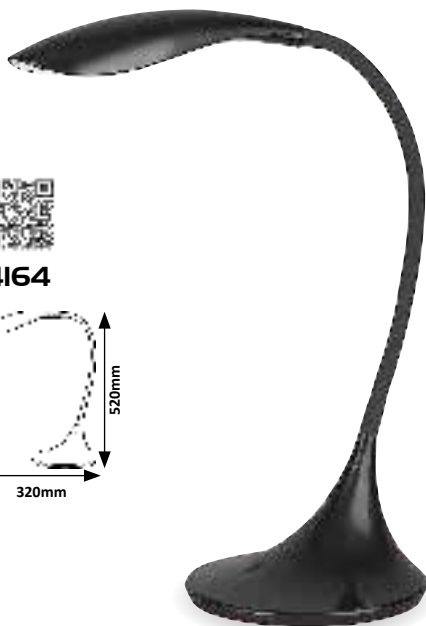
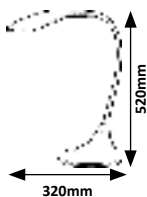

4167

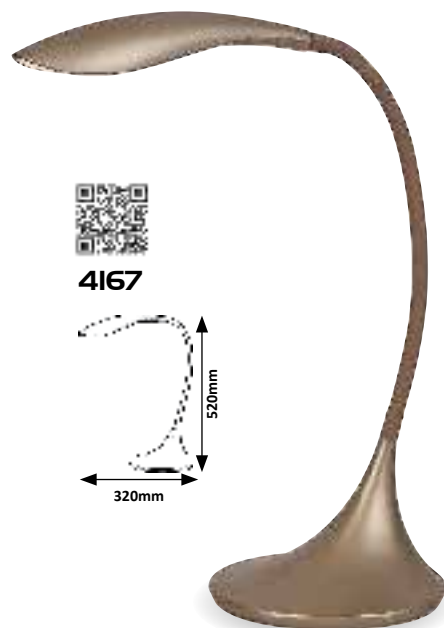
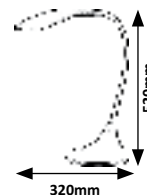

TIMOTHY



5429

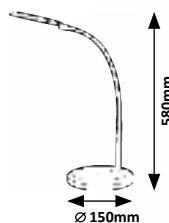

4164 (P)

LED / 5,3W
(520lm, 3000K) incl.
IP20 • black



4167 (P)

LED / 5,3W
(520lm, 3000K) incl.
IP20 • champagne



5429 (M P)

LED / 7,5W
(440lm, 4000K) incl.
IP20 • black/white



OSIAS

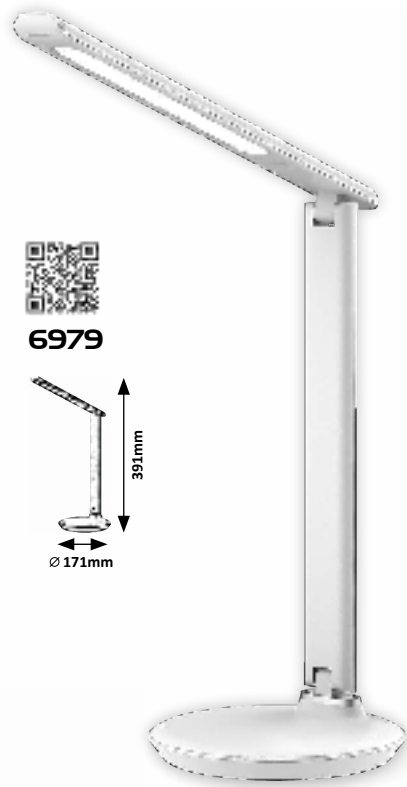

6979

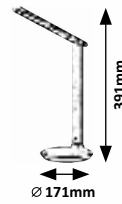

6980

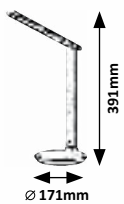

MISHA

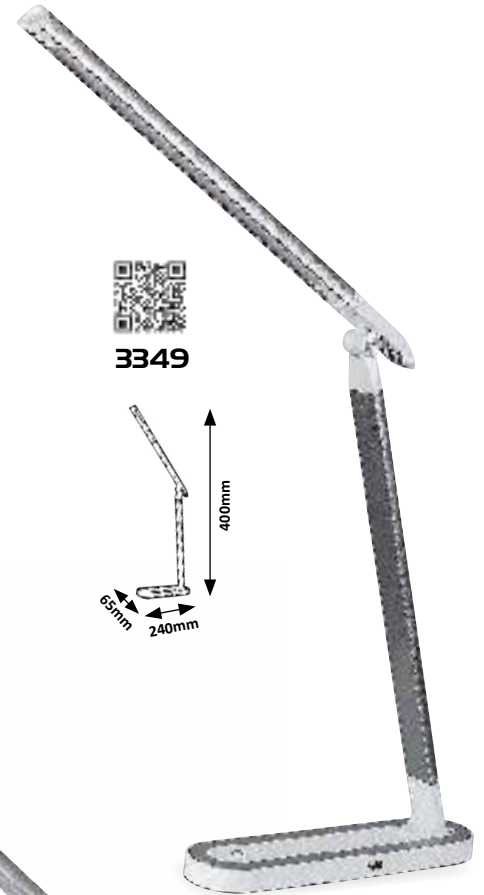

3349

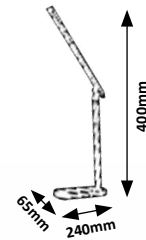

3350

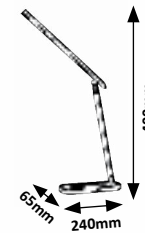

6979 (P)

LED / 9W
(400lm, 2700K-6500K) incl.
IP20 • white

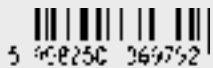

6980 (P)

LED / 9W
(400lm, 2700K-6500K) incl.
IP20 • black

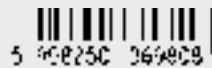

3349 (M P)

LED / 7W
(400lm, 4000K) incl.
IP20 • silver/white



3350 (M P)

LED / 7W
(400lm, 4000K) incl.
IP20 • silver/black

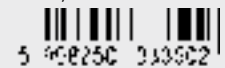

CARTER



6408

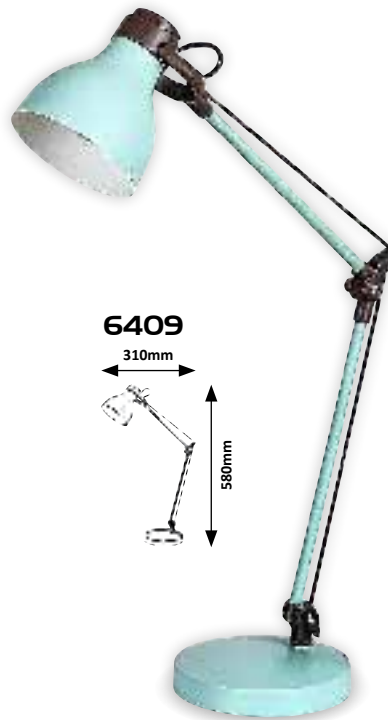
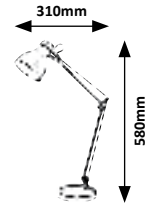

6409

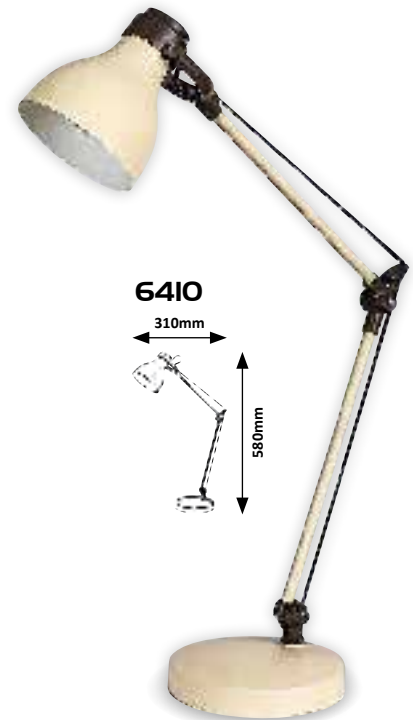
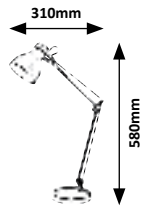

6410

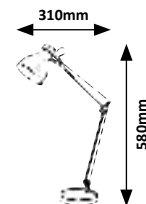

6408 (M)

☒ E14 / 1x max. 11W
IP20 •
matte black



5 368250 064008

6409 (M)

☒ E14 / 1x max. 11W
IP20 •
mint/brown

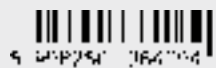

5 368250 064009

6410 (M)

☒ E14 / 1x max. 11W
IP20 •
beige/brown



5 368250 064010

SAMSON



4178

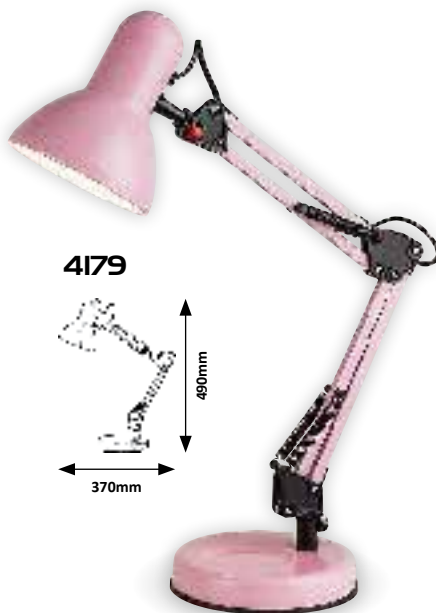

4179

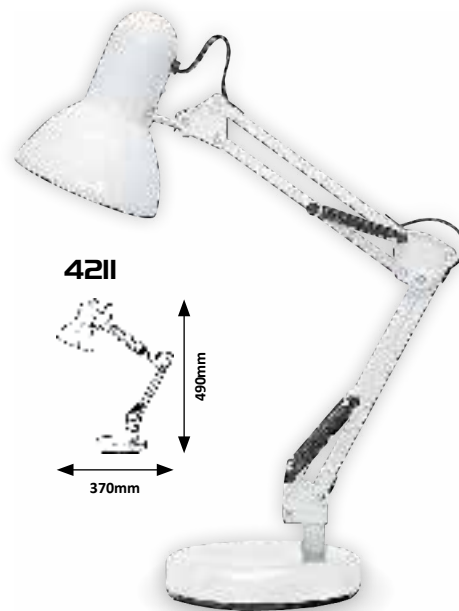

4211



4212



4213

4178



☒ E27 / 1x max. 60W
IP20 •
green



5 362250 341781

4179



☒ E27 / 1x max. 60W
IP20 •
rose



5 362250 34179E

4211



☒ E27 / 1x max. 60W
IP20 •
white



5 362250 34211E

4212



☒ E27 / 1x max. 60W
IP20 •
black



5 362250 34212E

4213



☒ E27 / 1x max. 60W
IP20 •
silver



5 362250 34213E

ARNO

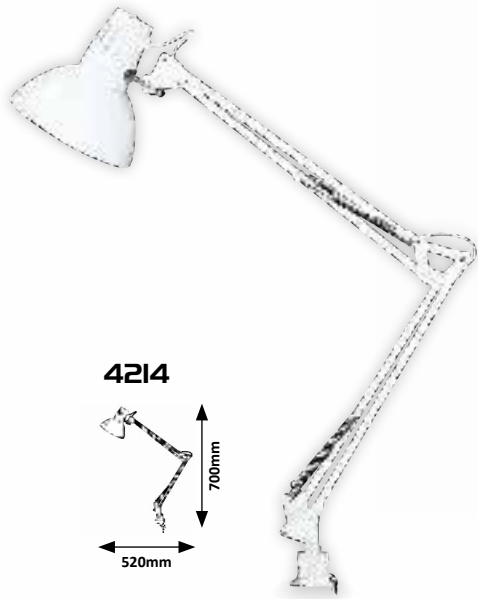

4214

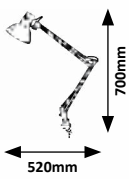

4215

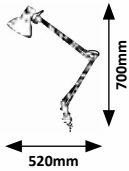

4216

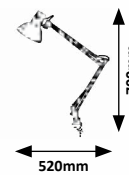

COLIN

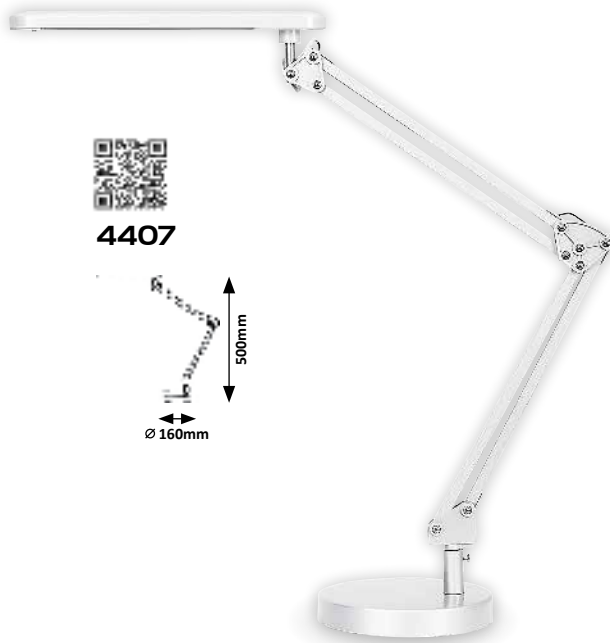

4407

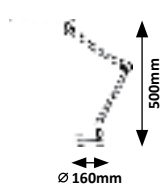

4408

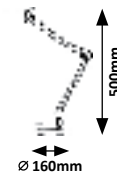

4214

(M)

☒ E27 / 1x max. 60W
IP20 •
white



5 362250 342140

4215

(M)

☒ E27 / 1x max. 60W
IP20 •
black



5 362250 342113

4216

(M)

☒ E27 / 1x max. 60W
IP20 •
silver



5 362250 342100

4407

(M P)

LED / 6W
(350lm, 4500K) incl.
IP20 •
white



5 362250 344072

4408

(M P)

LED / 6W
(350lm, 4500K) incl.
IP20 •
black



5 362250 344080

RAUL

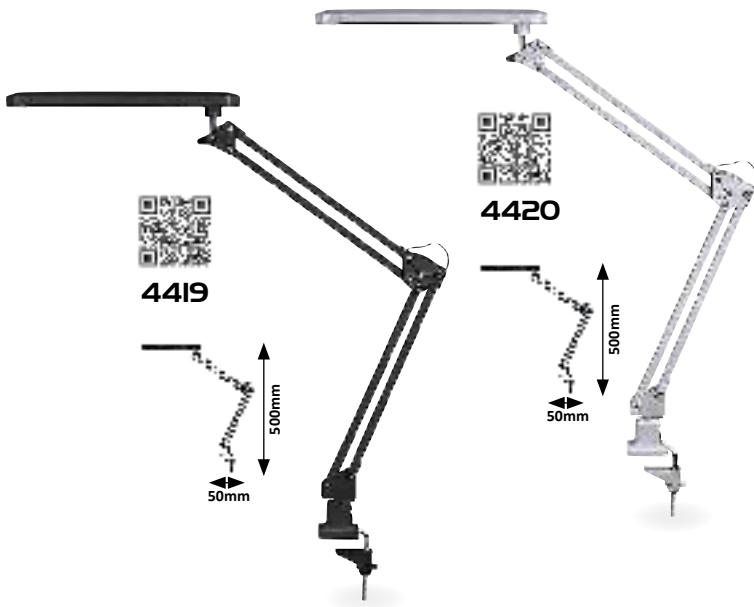

RONALD



4419 (M) (P)

LED / 6W
(350lm, 4500K) incl.
IP20 • black



5 368250 044190

4420 (M) (P)

LED / 6W
(350lm, 4500K) incl.
IP20 • silver



5 368250 044201

4334 (P)

LED / 5W
(350lm, 6400K) incl.
IP20 • black



5 368250 043341

4335 (P)

LED / 5W
(350lm, 6400K) incl.
IP20 • silver



5 368250 043350

CLARK



4255

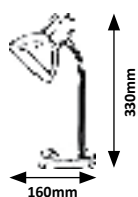

4205



4206



4207

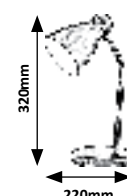

4208

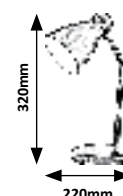

4255



☒ E27 / 1x max. 40W
IP20 •
chrome



4205



☒ E14 / 1x max. 40W
IP20 •
white/chrome



4206



☒ E14 / 1x max. 40W
IP20 •
silver/chrome



4207



☒ E14 / 1x max. 40W
IP20 •
blue/chrome



4208



☒ E14 / 1x max. 40W
IP20 •
green/chrome



DYLAN

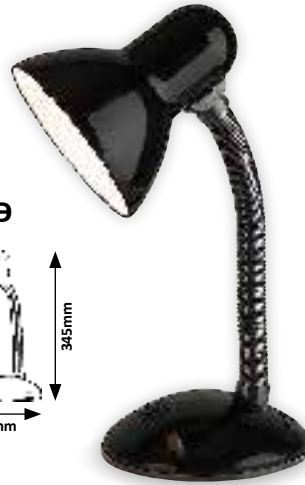

4169

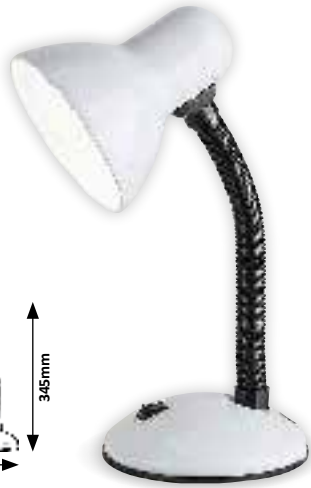
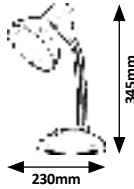

4168

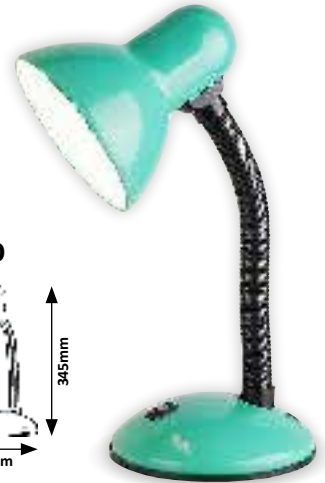
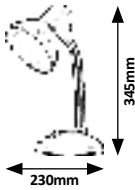

4170

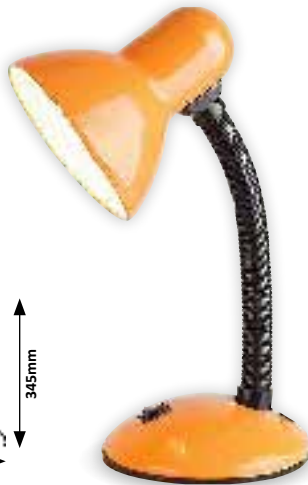

4171

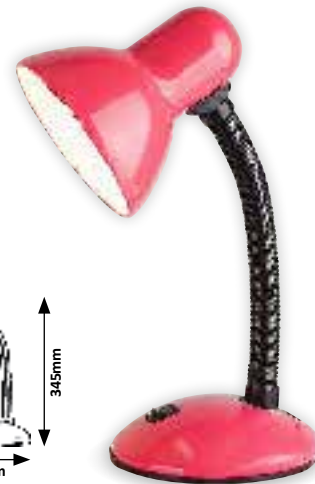
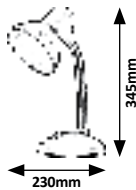

4172

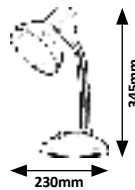

4168



☒ E27 / 1x max. 40W
IP20 •
white/black



5 368250 341682

4169



☒ E27 / 1x max. 40W
IP20 •
black



5 368250 341690

4170



☒ E27 / 1x max. 40W
IP20 •
green/black



5 368250 341708

4171



☒ E27 / 1x max. 40W
IP20 •
orange/black



5 368250 341712

4172



☒ E27 / 1x max. 40W
IP20 •
rose/black



5 368250 341720

BERRY



6779

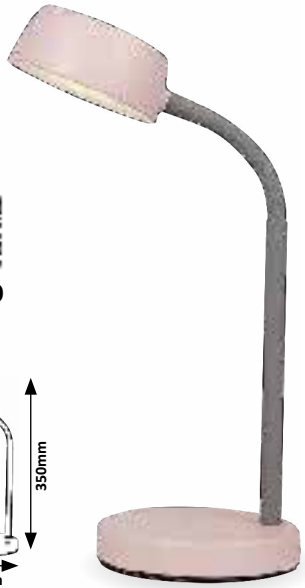
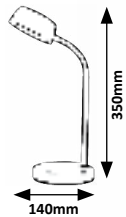

6778

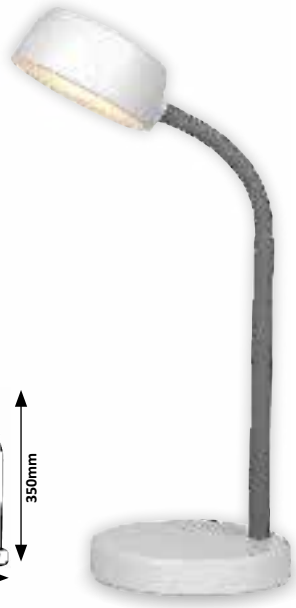
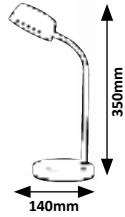

6780

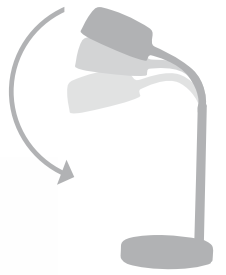
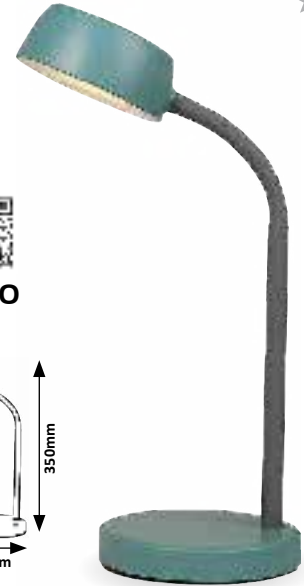
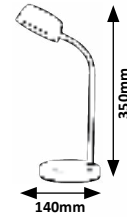

TEKLA



2977

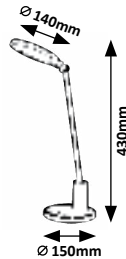

6448

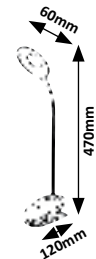

HARRIS



6778 (M)

LED / 4,5W
(350lm, 4000K) incl.
IP20 • white

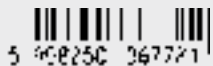

6779 (M)

LED / 4,5W
(350lm, 4000K) incl.
IP20 • rose

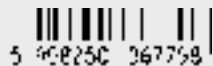

6780 (M)

LED / 4,5W
(350lm, 4000K) incl.
IP20 • blue



2977 (M P)

LED / 10W
(700lm, 3000K-6000K) incl.
IP20 • white



6448 (P)

LED / 4W
(180lm, 4000K) incl.
IP20 • DC 3,5V incl. • white

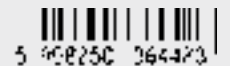

JEFF

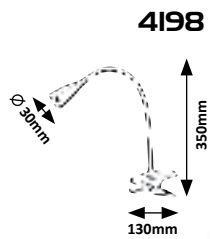
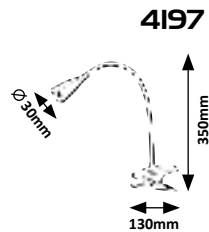
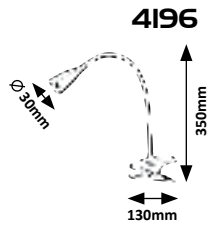
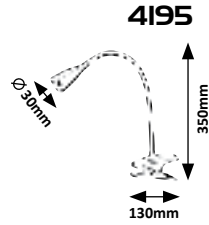

6448



4195 (P)

LED / 4,5W
(330lm, 3000K) incl.
IP20 •
blue



4196 (P)

LED / 4,5W
(330lm, 3000K) incl.
IP20 •
white



4197 (P)

LED / 4,5W
(330lm, 3000K) incl.
IP20 •
black



4198 (P)

LED / 4,5W
(330lm, 3000K) incl.
IP20 •
claret



DENNIS

CLIP

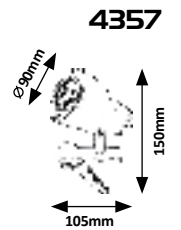
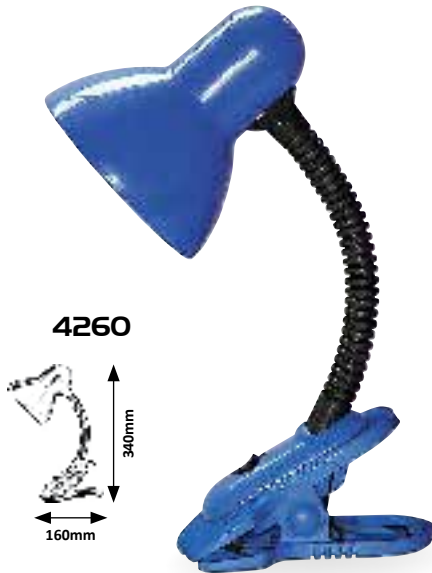
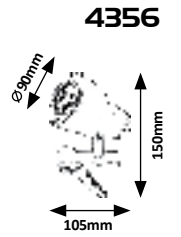
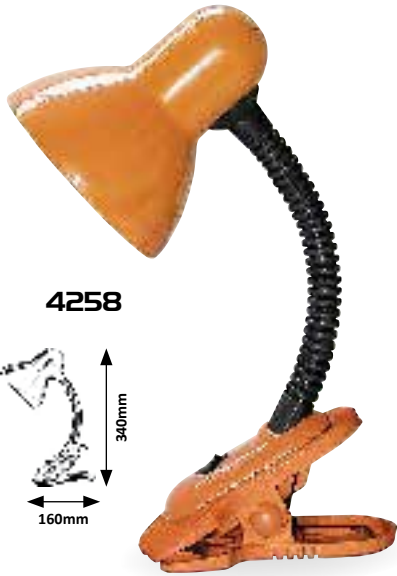

4257 (M) (P)

☒ E27 / 1x max. 40W
IP20 • □
green/black



4258 (M) (P)

☒ E27 / 1x max. 40W
IP20 • □
orange/black



4259 (M) (P)

☒ E27 / 1x max. 40W
IP20 • □
rose/black



4260 (M) (P)

☒ E27 / 1x max. 40W
IP20 • □
blue/black



4356 (P)

☒ E14 / R50 / 1x max. 40W
IP20 • □
white



4357 (P)

☒ E14 / R50 / 1x max. 40W
IP20 • □
black



NOAH



I477

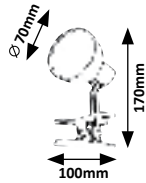

I478

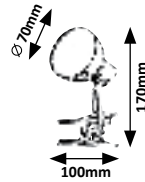

I479

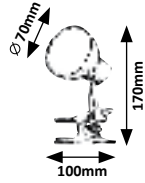

I480

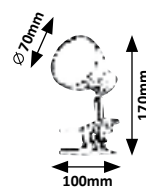

I481

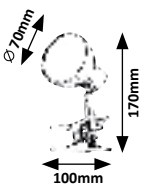

I482

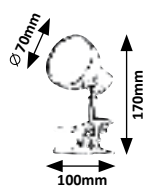

I477 (M P)

LED / 5W
(360lm, 3000K) incl.
IP20 • •
white



S 36225C 31477E

I478 (M P)

LED / 5W
(360lm, 3000K) incl.
IP20 • •
black



S 36225C 31478E

I479 (M P)

LED / 5W
(360lm, 3000K) incl.
IP20 • •
blue



S 36225C 31479E

I480 (M P)

LED / 5W
(360lm, 3000K) incl.
IP20 • •
black



S 36225C 31480E

I481 (M P)

LED / 5W
(360lm, 3000K) incl.
IP20 • •
green



S 36225C 31481E

I482 (M P)

LED / 5W
(360lm, 3000K) incl.
IP20 • •
rose



S 36225C 31482E

06

**CHILDREN AND
DECORATIVE LAMPS**

GYERMEK ÉS DEKOR LÁMPÁK

KINDER- UND DEKORLEUCHTEN





BIRDY



6389

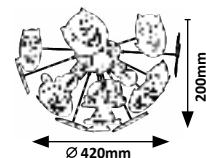

6390

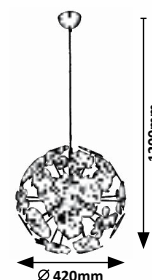

6389 **M P**

☒ E14 / 3x max. 40W
IP20
multicolour



5 352250 363890

6390 **M P**

☒ E14 / 3x max. 40W
IP20
multicolour



5 352250 363900

LINETT

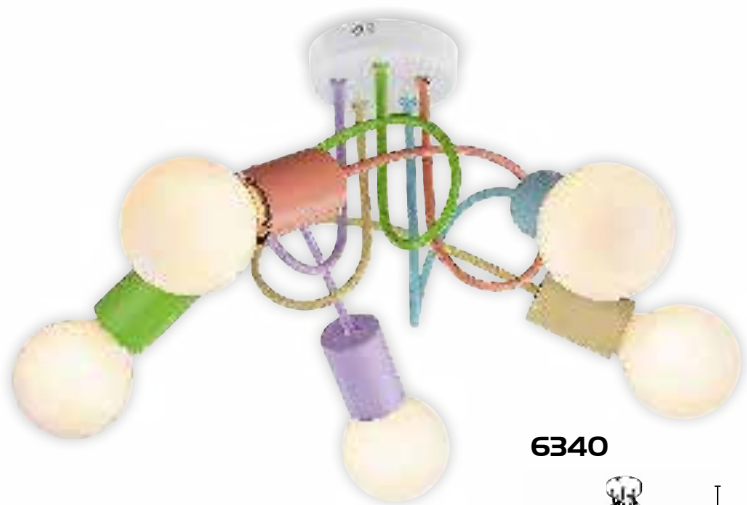

6340

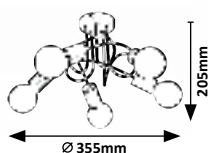

BEE

HELICOPTER

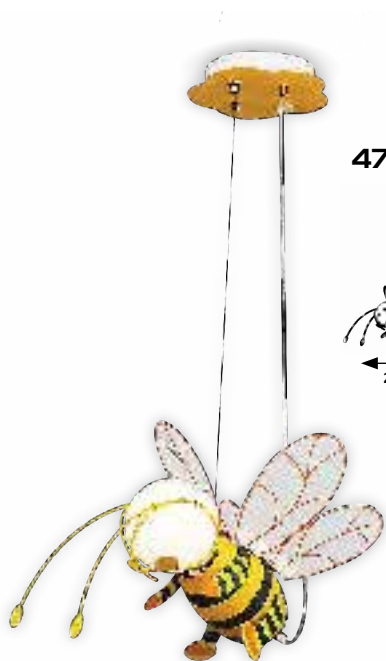

4718

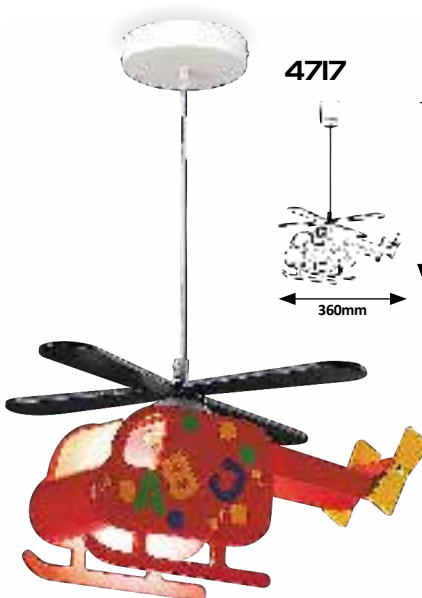
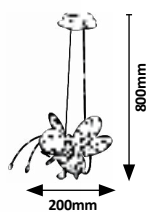

4717

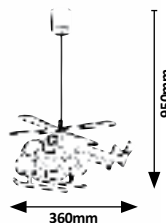

4717

(P)

☒ E27 / 1x max. 40W
IP20
multicolour



S 362250 347112

4718

(P)

☒ E27 / G90 / 1x max. 40 W
IP20
multicolour



S 362250 347112

6340

(M)

☒ E27 / 5x max. 40W
IP20
multicolour



S 362250 363400

HANKA

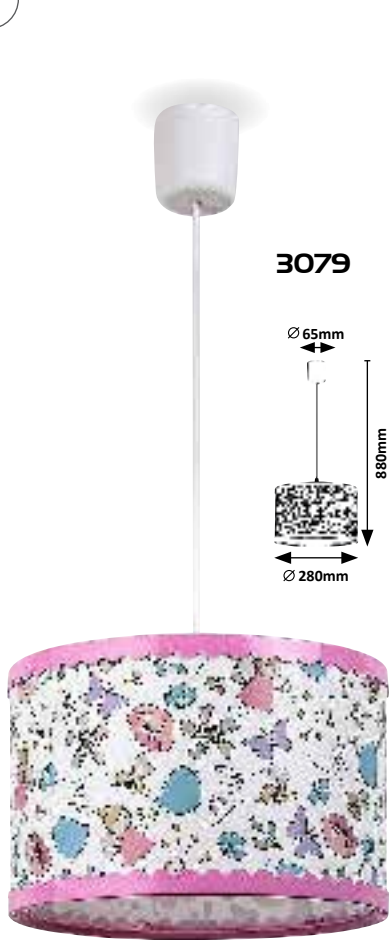

3079

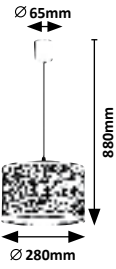

3080

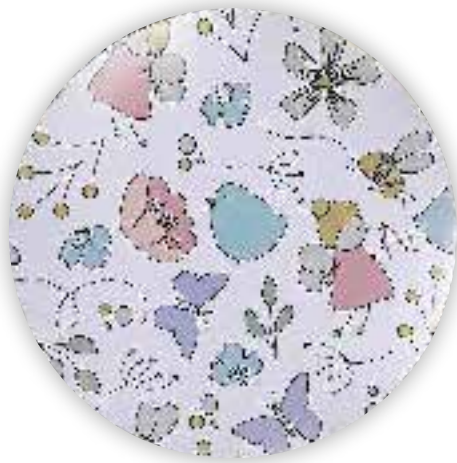
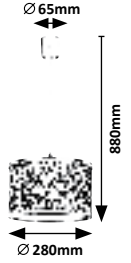

3416

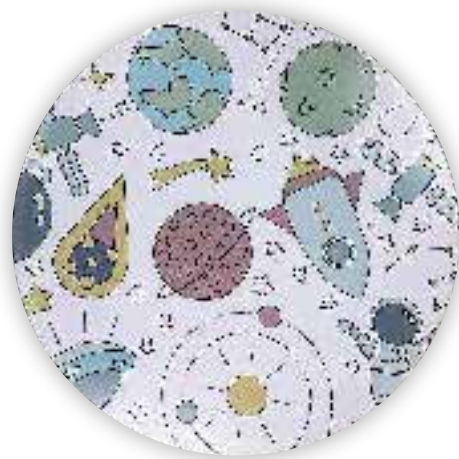
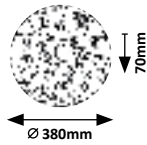

3417

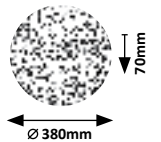

3079

P

⊠ E27 / 1x max. 40W
IP20
white/multicolour



3080

P

⊠ E27 / 1x max. 40W
IP20
white/multicolour

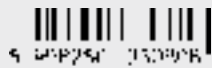

3416

M P

⊠ LED / 24W
(1560lm, 3000K) incl.
IP20 • 19810
white/multicolour



3417

M P

⊠ LED / 24W
(1560lm, 3000K) incl.
IP20 • 19811
white/multicolour





LEON

designed by
rabalux

Others /
383. Best match



4559

GUARANTEE
5
YEARS



4565

LED
built-in

EXCL.



4633



4571

WARM
White

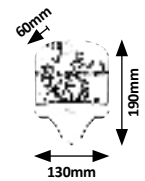

4559 (M) (G)

⊠ E27 / 2x max. 60W
IP20 • 682
multicolour



4565 (P)

⊠ LED / 0,3W incl.
DC 3V • 2x AA excl.
IP20 • 682
multicolour



4571 (P)

⊠ 7W (18lm, 2700K) incl.
E14 / 1x max. 7W
IP20 • 682
multicolour



4633 (PA)

⊠ IP20
multicolour



CATHY



Others / Best match
383.



4558

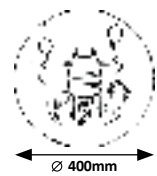

4632



4564



4570

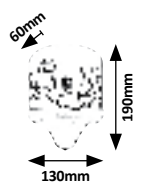

4564, 4565

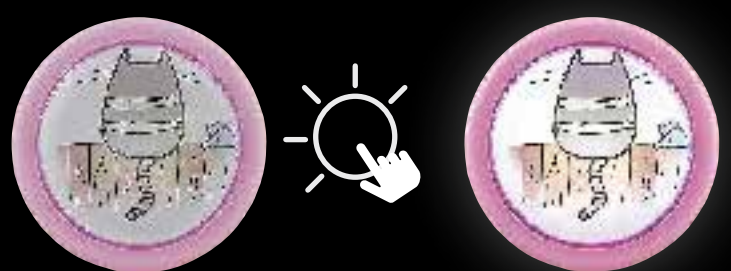

4558 (M G)

☒ E27 / 2x max. 60W
IP20 • 681
multicolour



S 362250 345521

4564 (P)

☒ LED / 0,3W incl.
DC 3V • 2x AA excl.
IP20 • 681
multicolour



S 362250 345622

4570 (P)

☒ 7W (18lm, 2700K) incl.
E14 / 1x max. 7W
IP20 • 681
multicolour



S 362250 345703

4632 (PA)

☒ IP20
multicolour



S 362250 346322

SHEPHERD

designed by **rabalux**

Others / Best match
383.



4557

GUARANTEE 5 YEARS



□ 400mm



4631

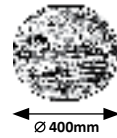

∅ 400mm



4563

LED built-in EXCL.



∅ 100mm

4563

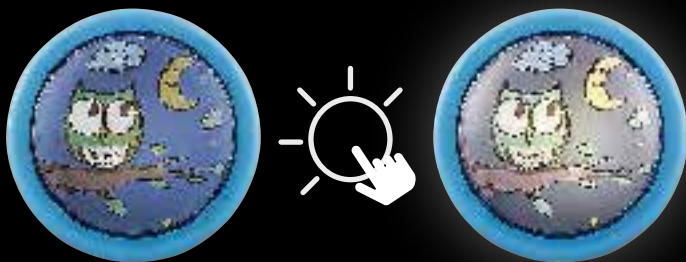

4569

WARM White

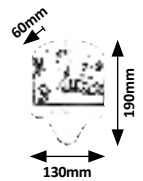

130mm

4557 (M) (G)

⊗ E27 / 2x max. 60W
IP20 • 680
multicolour



5 398296 045574

4563 (P)

⊗ LED / 0,3W incl.
DC 3V • 2x AA excl.
IP20 • 680
multicolour



5 398296 045635

4569 (P)

⊗ 7W (18lm, 2700K) incl.
E14 / 1x max. 7W
IP20 • 680
multicolour



5 398296 045697

4631 (PA)

⊗
IP20
multicolour



5 398296 046311

RICE



Others /
383. Best match

designed by
rabalux



4894



Ø 300mm

4898



Ø 400mm

BALOO



5409

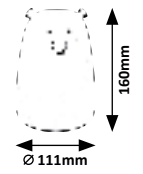

160mm

Ø 111mm



5410



160mm

Ø 111mm



5409, 5410

4894

PA

☒
IP20
white



5 90250 045340

4898

PA

☒
IP20
white



5 90250 045388

5409

SI

☒ RGB LED / 0,4W
(29lm, 3000K) incl.
DC 5V incl.
IP20 • white



5 90250 054055

5410

SI

☒ RGB LED / 0,4W
(29lm, 3000K) incl.
DC 5V incl.
IP20 • white

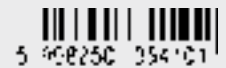

5 90250 054051



5730

MILO



5730



Ø 72mm



LINA



1470

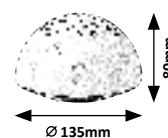

Ø 135mm



5675

MAGNUS



5675

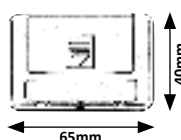

65mm

PUSH LIGHT



4703



Ø 100mm

5730



LED / 0,5W
(30lm, 4000K) incl.
DC 4,5V • 3xAAA excl. • 2m, 120°
IP20 • white

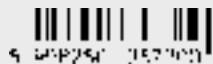

5 368250 314700

1470



RGB LED / 0,5W incl.
DC 4,5V • 3xAA excl.
IP20 • white



5 368250 314700

5675



LED / 0,5W
(35lm, 3000K) incl.
DC 3V • 3xAA excl.
IP20 • white/transparent



5 368250 356704

4703



LED / 0,3W incl.
DC 1,5V • 2xAA excl.
IP20 • white



5 368250 347030

AKALI

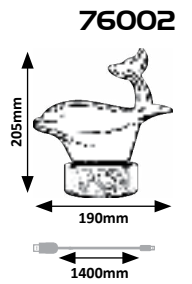
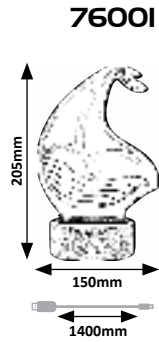

76001 **W A**

DC 5V / LED / 2W
 (50lm, 230lm;
 3000K) incl. • IP20 •
 beech/transparent



76002 **W A**

DC 5V / LED / 2W
 (50lm, 230lm;
 3000K) incl. • IP20 •
 beech/transparent



PUMPKIN

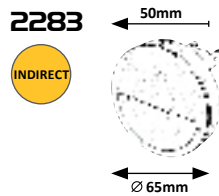
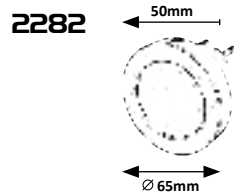

BILLY

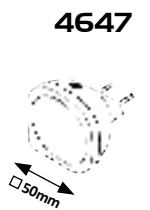

ABEL

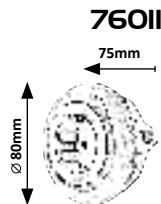
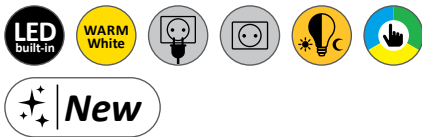

DEMBO

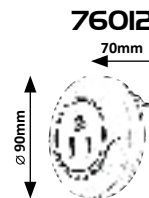
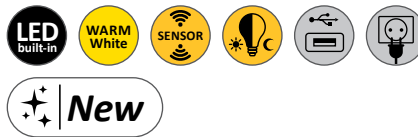

PARIS LUX

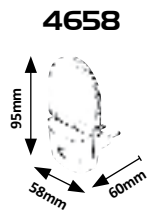

2282

P

LED / 0,5W
(5lm, 3000K) incl.
IP20
white



2283

P

LED / 0,5W
(5lm, 3000K) incl.
IP20
white



4647

P

LED / 0,5W
(2lm, 2700K) incl.
IP20
white



76011

P

LED / 0,54W
(5lm, 10lm;
3000K) incl. • IP20
white



76012

P

LED / 13,9W
(30lm, 35lm;
3000K) incl. • 0-3m, 90°
IP20 • white



4658

P

LED / 0,5W
(6lm, 4000K) incl.
IP20
white/transparent



SIGGY



76004

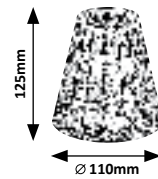

PIRIT



76003

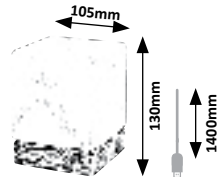

76004 **P**

DC 5V / LED / 2W
(40lm; 3000K) incl.
IP20
transparent



76003 **W G**

DC 5V / LED / 1,2W
(40lm, 60lm;
3000K) incl. • IP20 •



76004



MINKA



designed by
rabalux

7026

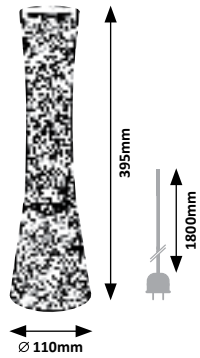

7028

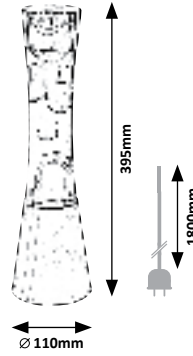

7030

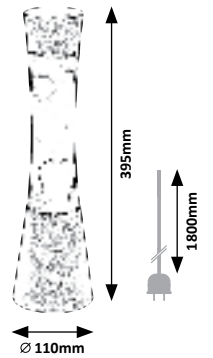

designed by
rabalux

7027

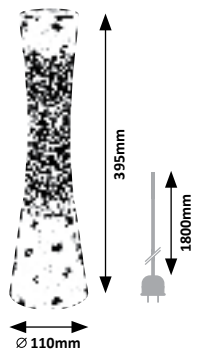

7029

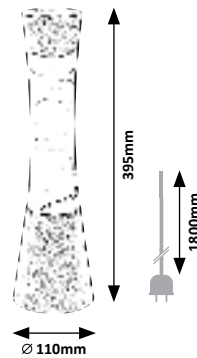

7026 (M) (G)

GY6.35 / 1x max. 20W
IP20 • □
19450
blue/transparent



S 36R25C 375202

7027 (M) (G)

GY6.35 / 1x max. 20W
IP20 • □
19450
rose/transparent



S 36R25C 375207

7028 (M) (G)

GY6.35 / 1x max. 20W
IP20 • □
19450
multicolour/transparent



S 36R25C 375280

7029 (M) (G)

GY6.35 / 1x max. 20W
IP20 • □
19450
silver/blue



S 36R25C 375293

7030 (M) (G)

GY6.35 / 1x max. 20W
IP20 • □
19450
silver/rose



S 36R25C 375300



19450

EN: The spare lightsource can be used for warranty purposes only, it is not to be sold separately!

HU: A pótfényforrás csak garanciális célokra használható fel, önállóan nem értékesíthető!

DE: Die Ersatzlichtquelle kann nur für Garantiezwecke verwendet werden, sie sollte nicht einzeln verkauft werden!

6949



CARNIVAL



6949

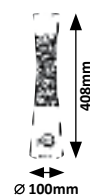

MARSHAL



4109



4110



6949



LED / 5W incl.
DC 5V
IP20 •
black/transparent



5 362250 369493

4109



25W incl.
E14 / S35 / 1x max. 25W
IP20 •
silver/red/yellow



5 362250 341295

4110



25W incl.
E14 / S35 / 1x max. 25W
IP20 •
silver/transparent/orange



5 362250 341101

LOLLIPOP 2

DOVCE

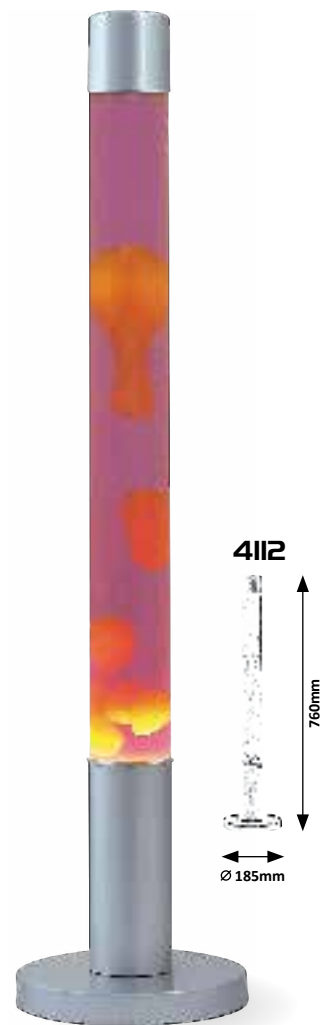
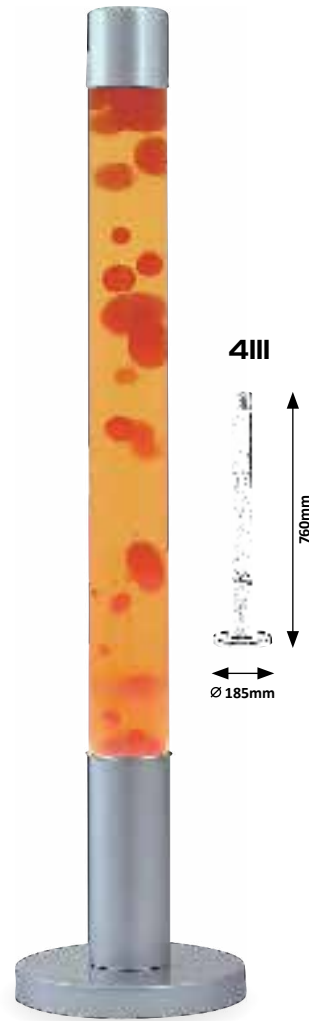

4106 (M) (G)

25W incl.
E14 / G45 / 1x max. 25W
IP20 • 
silver/orange/purple



S 362250 041004

4108 (M) (G)

25W incl.
E14 / G45 / 1x max. 25W
IP20 • 
silver/transparent/rose



S 362250 041008

4111 (M) (G)

55W incl.
E14 / R50 / 1x max. 55W
IP20 • 
silver/red/yellow



S 362250 041111

4112 (M) (G)

55W incl.
E14 / R50 / 1x max. 55W
IP20 • 
silver/orange/purple



S 362250 041112



LOLLIPOP RAINBOW



7011



GLITTER RAINBOW



7008

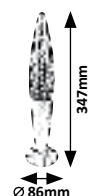



7011 **M G**

25W incl.
E14 / G45 / 1x max. 25W
IP20 • 
multicolour/transparent



7008 **M G**

15W incl.
E14 / G45 / 1x max. 15W
IP20 •  •  1793
multicolour/transparent



GLITTER

MILLIE



4113

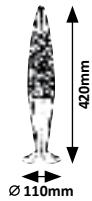

4114



4115



4533



4533



4113 (M) (G)

25W incl.
E14 / G45 / 1x max. 25W
IP20 •
silver/green



5 362250 341132

4114 (M) (G)

25W incl.
E14 / G45 / 1x max. 25W
IP20 •
silver/orange



5 362250 341140

4115 (M) (G)

25W incl.
E14 / G45 / 1x max. 25W
IP20 •
silver/purple



5 362250 341150

4533 (M) (G)

LED / 0,9W incl.
DC 5V
IP20
silver/transparent



5 362250 345338



WASABI



3680



3696

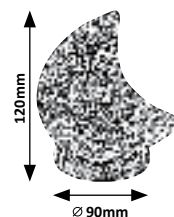

IGDRASIL



76009

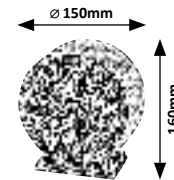

3680, 3696



3680 **W S**

RGB LED / 1W incl.
DC 5V
IP20 • ~2,4kg
brown/orange



5 392296 235800

3696 **W S**

RGB LED / 1W incl.
DC 5V
IP20 • ~2,4kg
brown/orange



5 392296 235801

76009 **W S**

E14 / 1x max. 15W
IP20 • brown/orange



5 474296 237000

FUJI

WARM
White

WOOD



4097

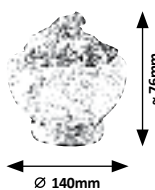

FLORES

WARM
White

WOOD



2676

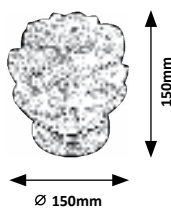

4097 **S** **W**

15W (90lm, 2700K) incl.
E14 / 1x max. 15W
IP20 • • ~2,5kg
brown/orange



5 362250 340373

2676 **S** **W**

15W (90lm, 2700K) incl.
E14 / 1x max. 15W
IP20 • • ~3,5kg
brown/orange



5 362250 320704



ROCK



4129
~65mm
~80,9mm



WARM White WOOD

4120



4127



4130

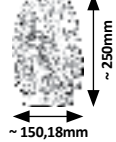

4120 (S) (W)

15W (90lm, 2700K) incl.
E14 / 1x max. 15W
IP20 • • ~2kg
brown/orange



5 368250 04 200

4127 (S) (W)

15W (90lm, 2700K) incl.
E14 / 1x max. 15W
IP20 • • ~2,7kg
brown/orange



5 368250 04 270

4129 (S)

~0,6kg
orange



5 368250 04 293

4130 (S) (W)

15W (90lm, 2700K) incl.
E14 / 1x max. 15W
IP20 • • ~8kg
brown/orange



5 368250 04 300

OZONE

WARM White WOOD



4093



VESUVIUS

WARM White WOOD

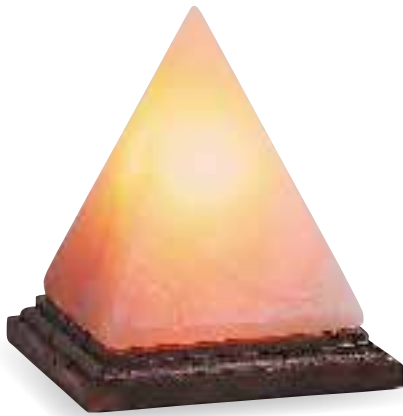

4096

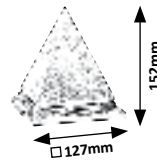

HEKLA

WARM White WOOD



2677

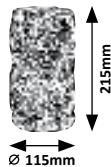

2677 (S) (W)

15W (90lm, 2700K) incl.
E14 / 1x max. 15W
IP20 • ~3,5kg
brown/orange



S 36225C 2267-1

4093 (S) (W)

15W (90lm, 2700K) incl.
E14 / 1x max. 15W
IP20 • ~2,5kg
brown/orange



S 36225C 240377

4096 (S) (W)

15W (90lm, 2700K) incl.
E14 / 1x max. 15W
IP20 • ~2,5kg
brown/orange



S 36225C 240378

07

**BATHROOM, PICTURE AND
CABINET LIGHTS**

**FÜRDŐSZOBAI, KÉP- ÉS
PULTMEGVILÁGÍTÓ LÁMPÁK**

**BADLEUCHTEN, BILDBE- UND
ARBEITSFLÄCHENBELEUCHTUNG**





ANTONIA



5895

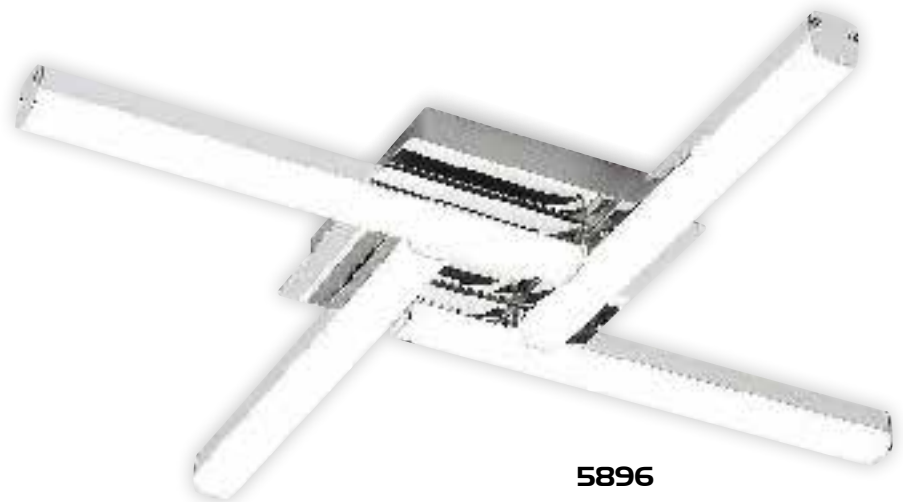
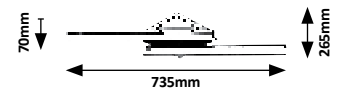

5896

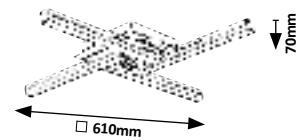

5895 (M) (P)

LED / 24W
(2360lm, 4000K) incl.
IP44
chrome/white



5896 (M) (P)

LED / 24W
(2200lm, 4000K) incl.
IP44
chrome/white



EVAN



2166

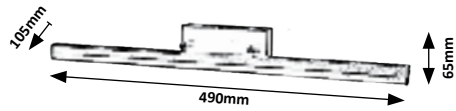

2167

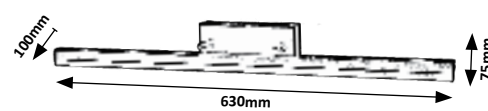

2168

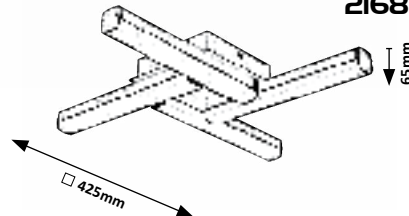

2166 (M) (P)

LED / 12W
(1300lm, 4000K) incl.
IP44
matte black/white



5 362250 121660

2167 (M) (P)

LED / 18W
(1850lm, 4000K) incl.
IP44
matte black/white



5 362250 121670

2168 (M) (P)

LED / 18W
(1750lm, 4000K) incl.
IP44
matte black/white



5 362250 121680

STEVE



5497

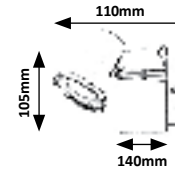

5498

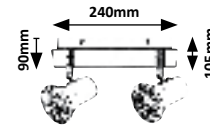

5500

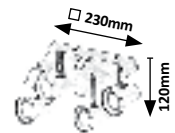

5499

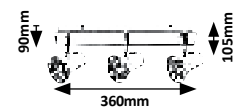

5497



LED / 4,5W (430lm, 4000K) incl.
GU10 / 1x max. 15W
IP44 • 19601
chrome/white



S 362250 354372

5498



LED / 9W (860lm, 4000K) incl.
GU10 / 2x max. 15W
IP44 • 19601
chrome/white



S 362250 354380

5499



LED / 13,5W (1290lm, 4000K) incl.
GU10 / 3x max. 15W
IP44 • 19601
chrome/white



S 362250 354390

5500



LED / 18W (1720lm, 4000K) incl.
GU10 / 4x max. 15W
IP44 • 19601
chrome/white



S 362250 355200

HAROLD



5021

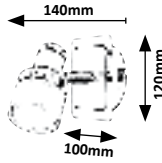

5022

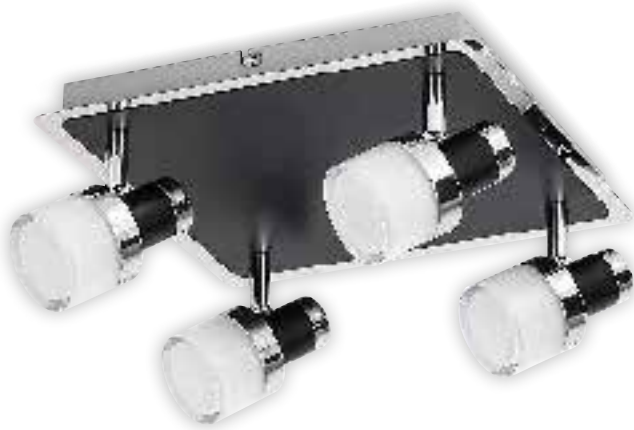
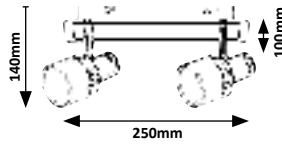

5024

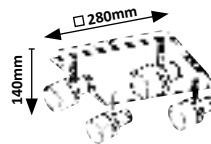

5023

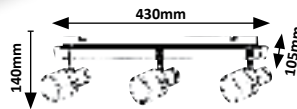

5021 (M P)

LED / 5W
(400lm, 4000K) incl.
IP44
chrome/black/opal glass



5 36256 350210

5022 (M P)

LED / 10W
(800lm, 4000K) incl.
IP44
chrome/black/opal glass

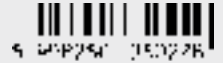

5 36256 350220

5023 (M P)

LED / 15W
(1200lm, 4000K) incl.
IP44
chrome/black/opal glass

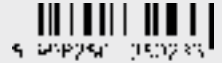

5 36256 350230

5024 (M P)

LED / 20W
(1600lm, 4000K) incl.
IP44
chrome/black/opal glass



5 36256 350240

TONY



5489

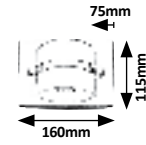

5490

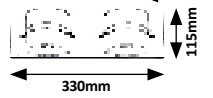

5491



5492

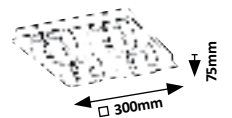

5489 (M) (P)

LED / 5W
(365lm, 4000K) incl.
IP44 • 19600
chrome/opal glass



S 392250 754897

5490 (M) (P)

LED / 10W
(730lm, 4000K) incl.
IP44 • 19600
chrome/opal glass



S 392250 754903

5491 (M) (P)

LED / 15W
(1095lm, 4000K) incl.
IP44 • 19600
chrome/opal glass



S 392250 754910

5492 (M) (P)

LED / 20W
(1460lm, 4000K) incl.
IP44 • 19600
chrome/opal glass



S 392250 754927

ATTICHUS



75001

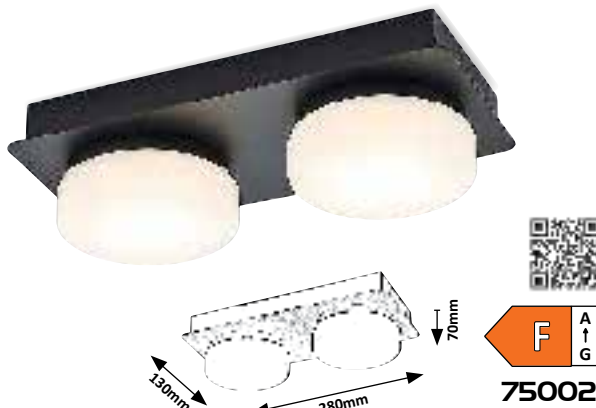

75002

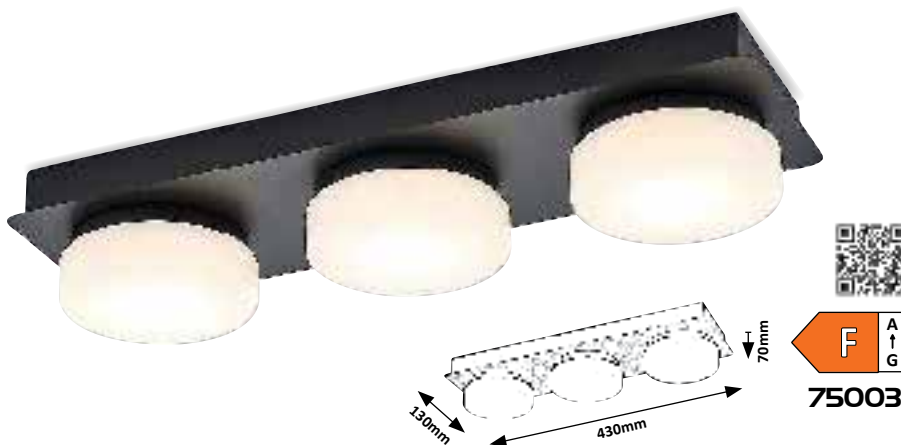

75003



75004



75001 (M P)

LED / 5W
 (670lm, 750lm;
 4000K) incl. • IP44 • 19604
 matte black/white



4176296 750015

75002 (M P)

LED / 11W
 (1200lm, 1430lm;
 4000K) incl. • IP44 • 19604
 matte black/white



4176296 750027

75003 (M P)

LED / 18W
 (1700lm, 2350lm;
 4000K) incl. • IP44 • 19604
 matte black/white



4176296 750039

75004 (M P)

LED / 21W
 (1900lm, 2670lm;
 4000K) incl. • IP44 • 19604
 matte black/white



4176296 750041



BECCA



210

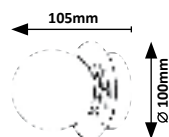

211

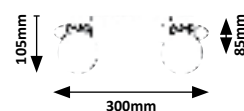

213

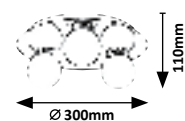

212

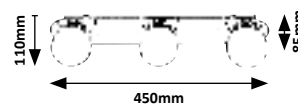

210 **MG**

☒ G9 / 1x max. 28W
IP44 • 19632
chrome/white



5 398250 321103

211 **MG**

☒ G9 / 2x max. 28W
IP44 • 19632
chrome/white



5 398250 321110

212 **MG**

☒ G9 / 3x max. 28W
IP44 • 19632
chrome/white



5 398250 321127

213 **MG**

☒ G9 / 3x max. 28W
IP44 • 19632
chrome/white



5 398250 321134

BEATA



5716

150mm



5717

150mm



5718

150mm



5716 (M) (P)

LED / 5W
(465lm, 4000K) incl.
IP44
chrome/white



S 36R25C 357164

5717 (M) (P)

LED / 10W
(930lm, 4000K) incl.
IP44
chrome/white



S 36R25C 357171

5718 (M) (P)

LED / 15W
(1400lm, 4000K) incl.
IP44
chrome/white



S 36R25C 357182



AVIVA



5087

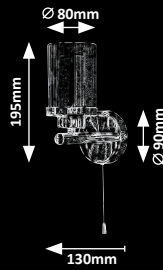

5088

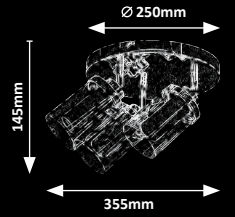

NIAGARA



2194

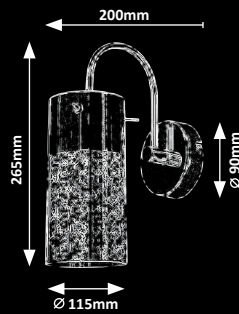

2195

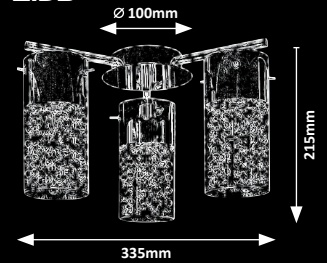

5087 **M G**

☒ G9 / 1x max. 28W
IP44 • □
▲ 19850 • ▣ 19851
chrome/opal glass

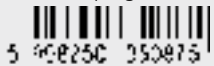

5 902250 250075

5088 **M G**

☒ G9 / 3x max. 28W
IP44
▲ 19850 • ▣ 19851
chrome/opal glass

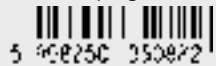

5 902250 250072

2194 **M G**

☒ E14 / 1x max. 40W
IP44
▲ 19953 • ▣ 19954
chrome/transparent



5 902250 221243

2195 **M G**

☒ E14 / 3x max. 40W
IP44
▲ 19953 • ▣ 19954
chrome/transparent



5 902250 221200

ANTOINE



3207

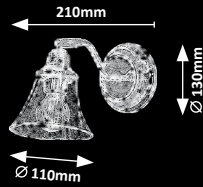

3208

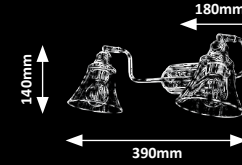

3209

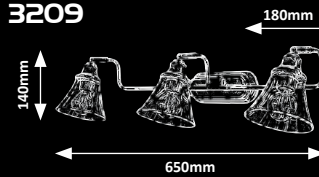

3210

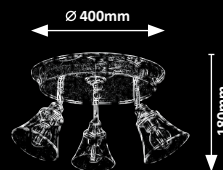

3207 (M) (G)

☒ E14 / 1x max. 40W
IP44 • 19955
chrome/transparent



5 362296 332270

3208 (M) (G)

☒ E14 / 2x max. 40W
IP44 • 19955
chrome/transparent



5 362296 332280

3209 (M) (G)

☒ E14 / 3x max. 40W
IP44 • 19955
chrome/transparent



5 362296 332293

3210 (M) (G)

☒ E14 / 3x max. 40W
IP44 • 19955
chrome/transparent



5 362296 332300



TIRINA



New



75005

Ø 150mm

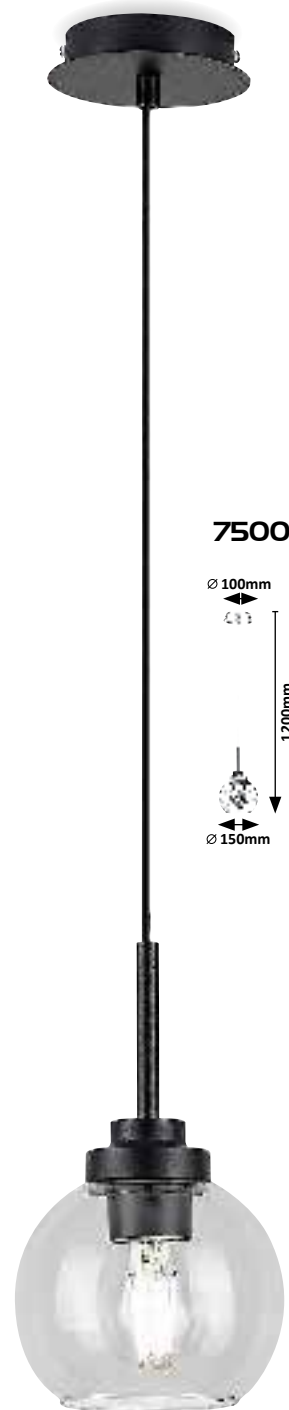
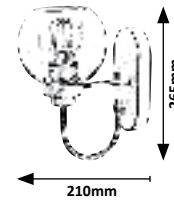

75006

Ø 100mm

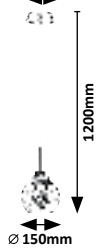

75005 **M G**

☒ E27 / 1x max. 15W
IP44 • 19773
matte black/transparent



= 4 746 294 75 70005

75006 **M G**

☒ E27 / 1x max. 15W
IP44 • 19773
matte black/transparent



= 4 746 294 75 70006

YAGO



2in1



3309

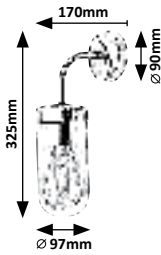

3310

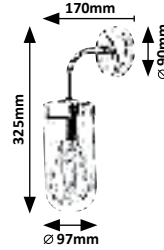

LIAM



6230

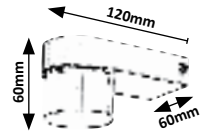

2in1

Bathroom/Outdoor lamp • Fürdőszobai/Kültéri lámpa • Badleuchten/Aussenleuchten



3309

(M) (G)

E27 / 1x max. 60W
IP44 • 19984
chrome/transparent



3310

(M) (G)

E27 / 1x max. 60W
IP44 • 19984
matte black/transparent



6230

(M)

LED / 5W
(400lm, 4000K) incl.
IP44
chrome

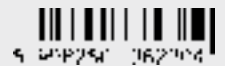

BETTY

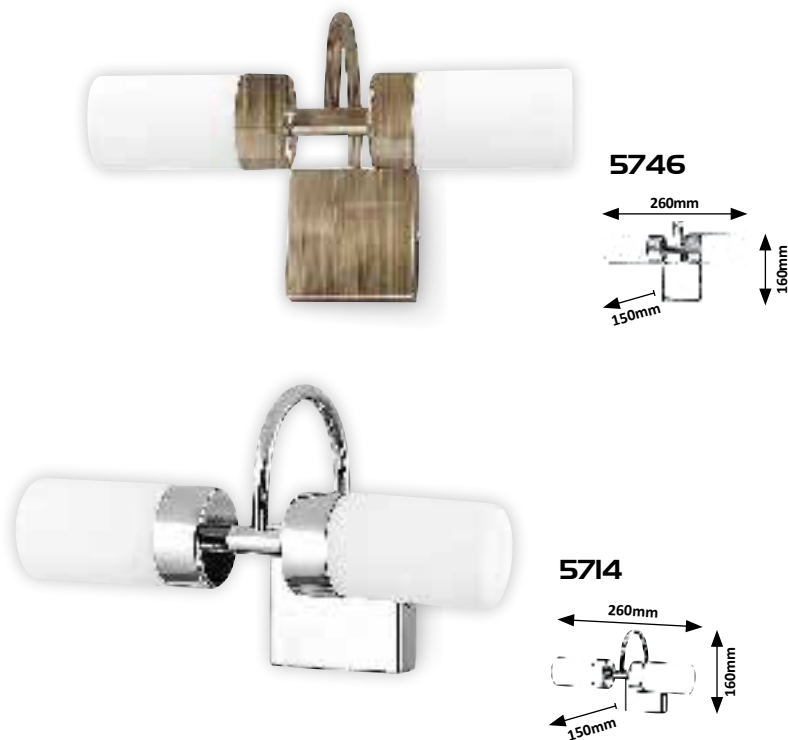

JIM

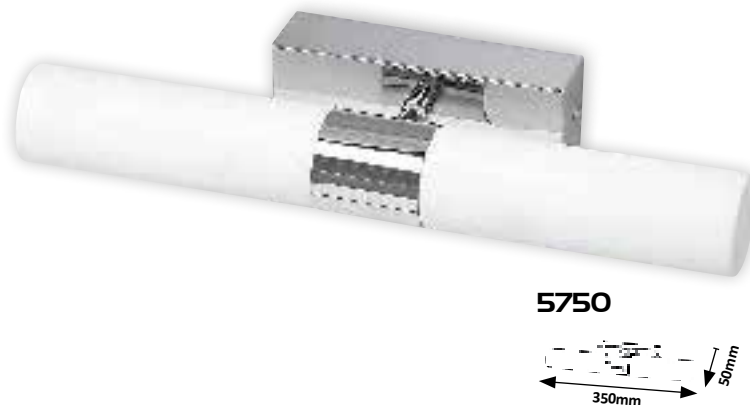

5713 **MG**

LED / 4W
(371lm, 4000K) incl.
IP44 • 19587
chrome/opal glass



S 362250 357133

5714 **MG**

LED / 8W
(785lm, 4000K) incl.
IP44 • 19588
chrome/opal glass



S 362250 357140

5745 **MG**

LED / 4W
(371lm, 4000K) incl.
IP44 • 19587
bronze/white



S 362250 357404

5746 **MG**

LED / 8W
(785lm, 4000K) incl.
IP44 • 19588
bronze/white



S 362250 357401

5749 **MG**

LED / 5W
(400lm, 4000K) incl.
IP44 • 19589
chrome/white



S 362250 357492

5750 **MG**

LED / 10W
(800lm, 4000K) incl.
IP44 • 19590
chrome/white



S 362250 357500

TOGO

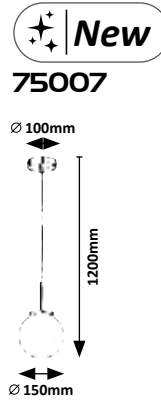
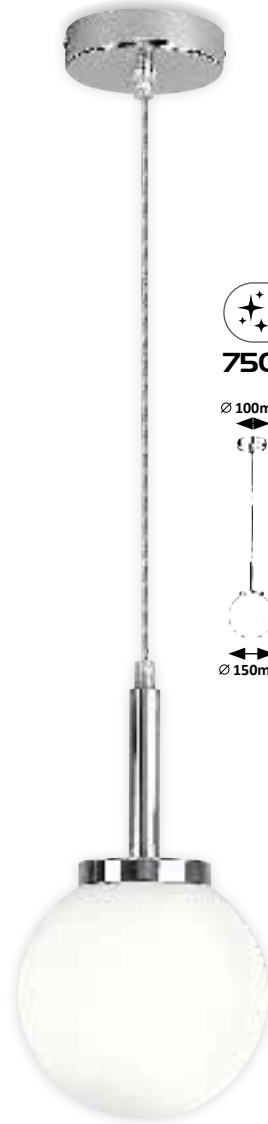
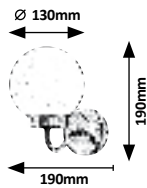
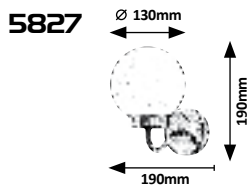
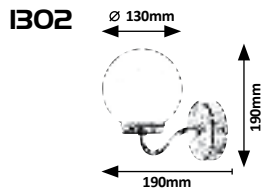

IB02 **MG**

☒ E14 / 1x max. 40W
IP44 • 9973
bronze/white



5 368296 313223

5827 **MG**

☒ E14 / 1x max. 40W
IP44 • 9973
chrome/white



5 368296 355277

75007 **MG**

☒ E14 / 1x max. 40W
IP44 • 19809
chrome/white



5 368296 750077

2982

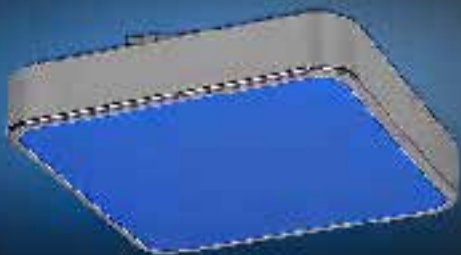
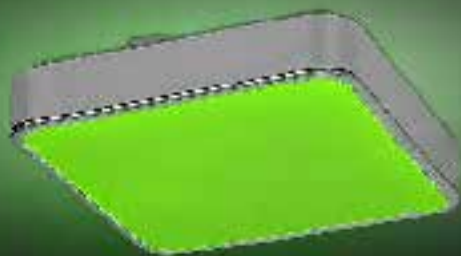

WOLIMIR



2982

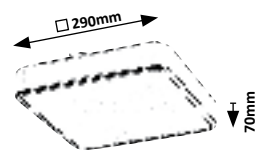

BALTHASAR



3464

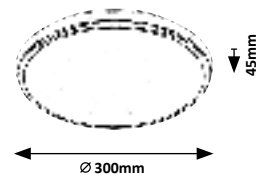

2982 (MA)

LED / 22W
(1800lm, 3000K-6000K) incl.
IP44 • 19643 • 519
chrome/white



5 362250 223820

3464 (MP)

LED / 18W
(1600lm, 3000K-6500K) incl.
IP44 • 19989 • 557
chrome/white



5 362250 334640

KLEMENTINE



75008

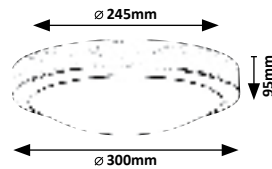

TOMA



3874

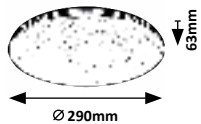

3875

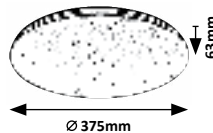

3464



75008 (M) (G)

☒ E27 / 2x max. 40W
IP44 • 19927
chrome/white



3874 (M) (A)

☒ LED / 20W
(1400lm, 4000K) incl.
IP44 • 19871
chrome/white

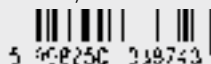

3875 (M) (A)

☒ LED / 30W
(2100lm, 4000K) incl.
IP44 • 19872
chrome/white

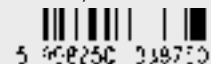



LARCIA



75009

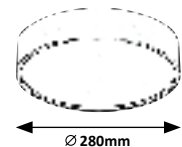

75010

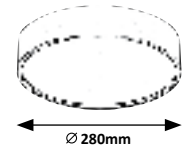

75009



LED / 18W
(970lm, 1800lm;
4000K) incl. • IP44 • 19992
black/white



75010



LED / 18W
(1060lm, 1800lm;
4000K) incl. • IP44 • 19134
silver/white



LAMBERT

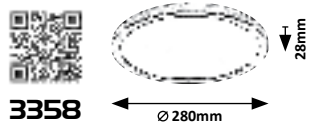

LUCAS

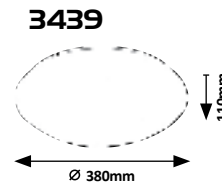
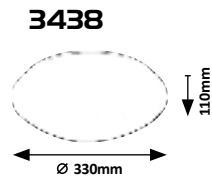
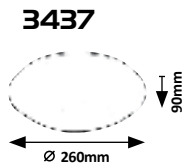

3358 (P)
 LED / 15W
 (1500lm, 4000K) incl.
 IP44
 silver/white



3359 (P)
 LED / 15W
 (1500lm, 4000K) incl.
 IP44
 silver/white



3437 (MP)
 LED / 12W
 (780lm, 4000K) incl.
 IP44 • 19714
 white



3438 (MP)
 LED / 18W
 (1170lm, 4000K) incl.
 IP44 • 19715
 white



3439 (MP)
 LED / 24W
 (1560lm, 4000K) incl.
 IP44 • 19716
 white





SLAVA

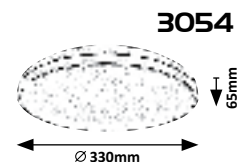

SHAUN



2692

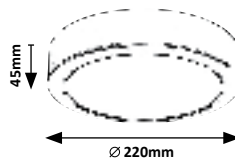

2693

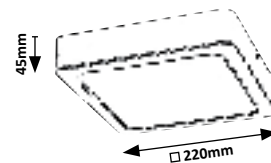

3054 (M) (A)

LED / 18W
(1170lm, 3000K) incl.
IP44 • 19902
black/white

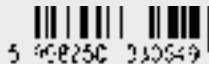

5 908250 300649

2692 (P)

LED / 24W
(2400lm, 4000K) incl.
IP44
black/white



5 908250 300644

2693 (P)

LED / 24W
(2400lm, 4000K) incl.
IP44
black/white



5 908250 300641

COCO



5274

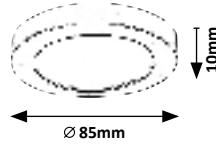

5275

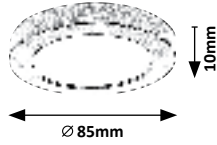

5276

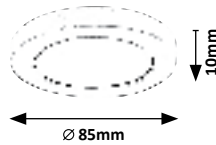

5274

(P)

LED / 3W
 (☰) 220lm; (☲) 400lm, 4000K) incl.
 IP44 • (↓) 25mm
 black/white



5 908253 372749

5275

(P)

LED / 3W
 (☰) 230lm; (☲) 400lm, 4000K) incl.
 IP44 • (↓) 25mm
 silver/white



5 908253 372754

5276

(P)

LED / 3W
 (☰) 250lm; (☲) 400lm, 4000K) incl.
 IP44 • (↓) 25mm
 white



5 908253 372763

TURGON



75016

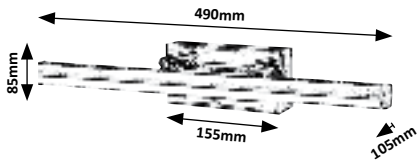

75017

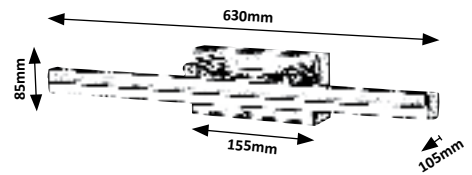

SILAS



5719

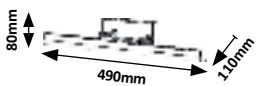

5727



5720

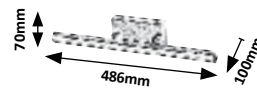

5729

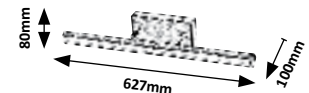

75016 (M) (P)

LED / 13W
(1190lm, 1470lm;
3000K, 4000K, 6000K) incl.
IP44 • chrome/white



75017 (M) (P)

LED / 20W
(1750lm, 2120lm;
3000K, 4000K, 6000K) incl.
IP44 • chrome/white



5719 (M) (P)

LED / 12W
(1180lm, 4000K) incl.
IP44
chrome/white



5720 (M) (P)

LED / 12W
(1180lm, 4000K) incl.
IP44
bronze/white



5727 (M) (P)

LED / 18W
(1700lm, 4000K) incl.
IP44
chrome/white



5729 (M) (P)

LED / 18W
(1700lm, 4000K) incl.
IP44
bronze/white



JOHN



5721

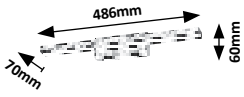

6130

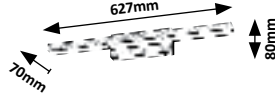

5721



5897

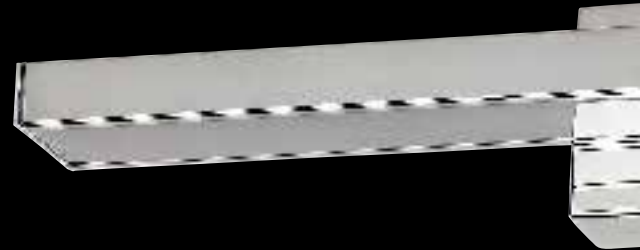

5897

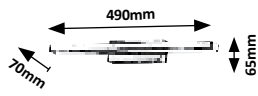

6129



5732

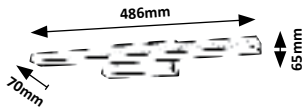

5732

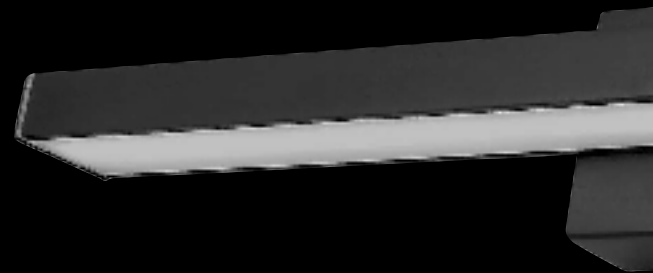

5721 (M) (P)

LED / 12W
(1080lm, 4000K) incl.
IP44
bronze/white



5 368250 357218

5732 (M) (P)

LED / 12W
(930lm, 3000K) incl.
IP44
matte black/white

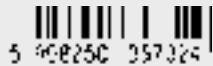

5 368250 357324

5897 (M) (P)

LED / 12W
(1080lm, 4000K) incl.
IP44
chrome/white



5 368250 358970

6129 (M) (P)

LED / 18W
(1300lm, 4000K) incl.
IP44
chrome/white

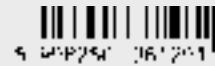

5 368250 361291

6130 (M) (P)

LED / 18W
(1300lm, 4000K) incl.
IP44
bronze/white



5 368250 361307



JAKUB



3480

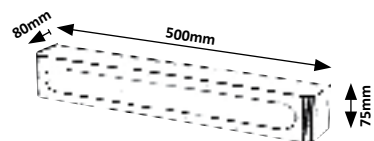

DANTON



6270

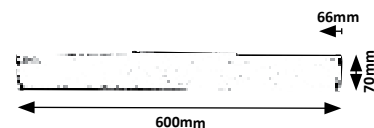

3480 (M) (P)

LED / 12W
(1280lm, 4000K) incl.
IP44
chrome/white



5 392250 334800

6270 (M) (P)

LED / 14W
(1220lm, 3000K) incl.
IP44
chrome/white

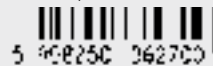

5 392250 362700

MATT



2065

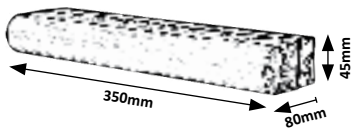

2066

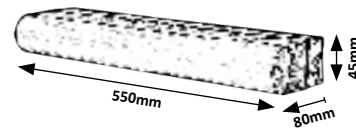

ABBEY



5787

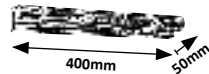

5786



2065 (M P)

LED / 10W
(960lm, 4000K) incl.
IP44
chrome/white



5 362250 225670

2066 (M P)

LED / 15W
(1360lm, 4000K) incl.
IP44
chrome/white



5 362250 225673

5786 (M P)

LED / 10W
(900lm, 3000K) incl.
IP44
antique bronze



5 362250 257807

5787 (M P)

LED / 10W
(900lm, 4000K) incl.
IP44
chrome



5 362250 257874

2114, 2115 3in1



Wall • Fal • Wand



Mirror • Tükör • Spiegel



Furniture • Bútor • Möbel

ALBINA



I448

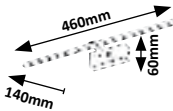

I449

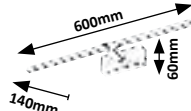

I464

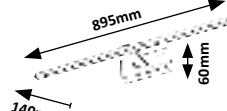

LEVON



2114

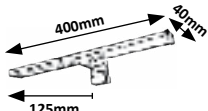

2115

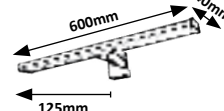

I448 (M) (P)

LED / 8W
(450lm, 4000K) incl.
IP23
matte white



I449 (M) (P)

LED / 12W
(795lm, 4000K) incl.
IP23
matte white



I464 (M) (P)

LED / 18W
(900lm, 4000K) incl.
IP23
matte white



2114 (M) (P)

LED / 8W
(560lm, 4000K) incl.
IP44
chrome



2115 (M) (P)

LED / 12W
(840lm, 4000K) incl.
IP44
chrome



EVRON

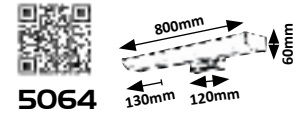
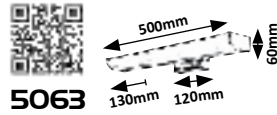
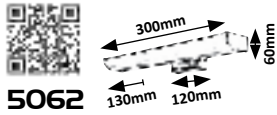

ANDREW

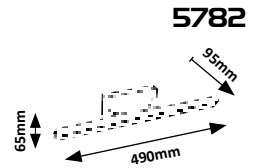

BASTIAN

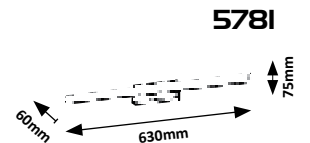

5062 (M) (P)

LED / 5W
(400lm, 4000K) incl.
IP44
chrome/white

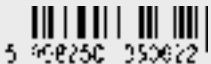

5 902250 350622

5063 (M) (P)

LED / 7,5W
(600lm, 4000K) incl.
IP44
chrome/white

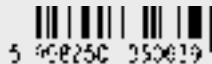

5 902250 350619

5064 (M) (P)

LED / 13,5W
(1080lm, 4000K) incl.
IP44
chrome/white

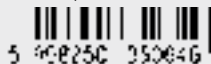

5 902250 350646

5782 (M) (P)

LED / 12W
(820lm, 3000K) incl.
IP44
matte white



5 902250 357820

5781 (M) (P)

LED / 13W
(1120lm, 4000K) incl.
IP44
chrome



5 902250 357812



78001

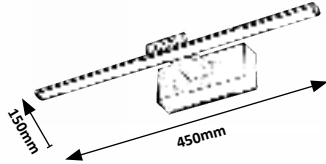

78002

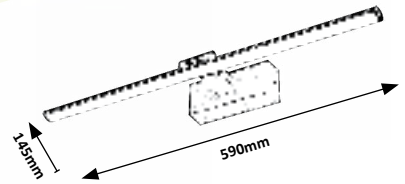

78001 M P A

LED / 8W
(420lm, 700lm;
3000K) incl. • IP20
black/white



= 476396 780017

78002 M P A

LED / 12W
(630lm, 1100lm;
3000K) incl. • IP20
black/white



= 476396 780020



PICTURE GUARD

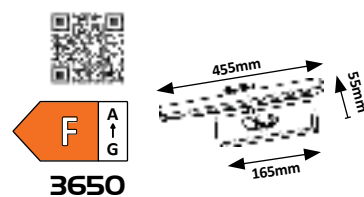
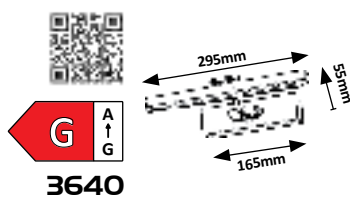
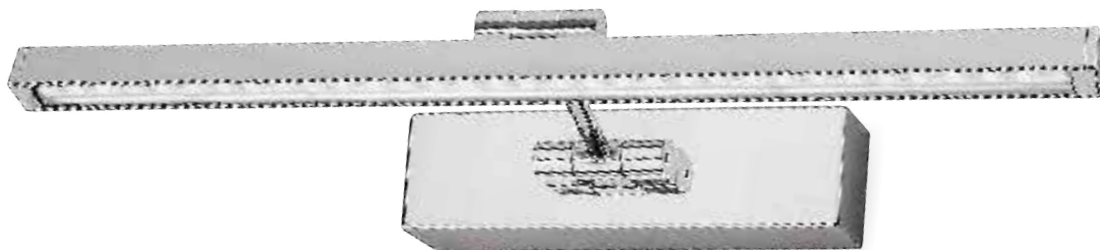

PICTURE SLIM

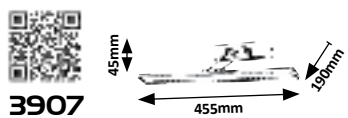
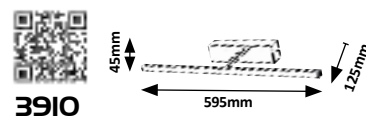
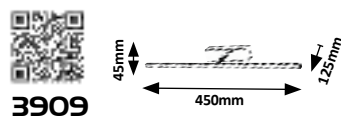
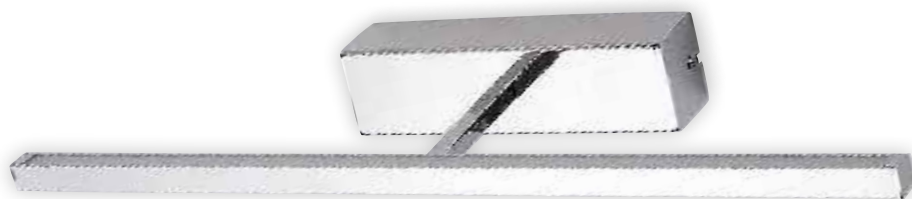

3640



LED / 5W
(300lm, 3000K) incl.
IP20
chrome



3650



LED / 8W
(580lm, 3000K) incl.
IP20
chrome



3907



LED / 8W
(316lm, 4000K) incl.
IP20
chrome



3908



LED / 12W
(466lm, 4000K) incl.
IP20
chrome



3909



LED / 8W
(321lm, 4000K) incl.
IP20
chrome



3910



LED / 12W
(554lm, 4000K) incl.
IP20
chrome



PICTURE LIGHT

3641

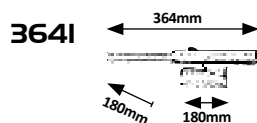

3642

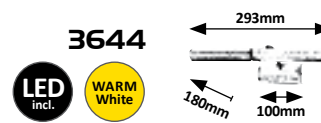
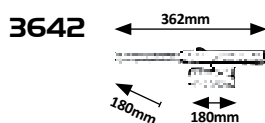

3641



⊠ E14 / T25 / 2x max. 40W
IP20
satin chrome



S 36425C 330411

3642



⊠ E14 / T25 / 2x max. 40W
IP20
bronze



S 36425C 33042E

3643



⊠ 28W (370lm, 2700K) incl.
G9 / 2x max. 40W
IP20
satin chrome



S 36425C 33043E

3644



⊠ 28W (370lm, 2700K) incl.
G9 / 2x max. 40W
IP20
bronze



S 36425C 33044E

LUDOVIC



I496

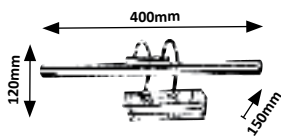

I498

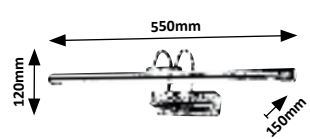

I496 (M) (P)

LED / 9W
(810lm, 3000K) incl.
IP20
bronze



5 398250 014360

I498 (M) (P)

LED / 13W
(1170lm, 3000K) incl.
IP20
bronze



5 398250 014383

PERIODIC



PAULA



6749

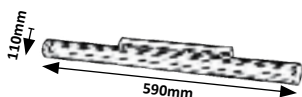

6750

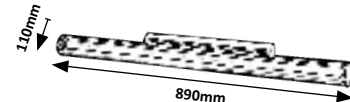

5800 (M) (G)

☒ E14 / 1x max. 40W
IP20 • 9730
chrome/transparent/opal glass



5 362250 355200

5808 (M) (G)

☒ E14 / 2x max. 40W
IP20 • 9593
chrome/transparent/opal glass



5 362250 355200

5809 (M) (G)

☒ E14 / 3x max. 40W
IP20 • 9594
chrome/transparent/opal glass



5 362250 355203

6749 (M) (P) (G)

☒ LED / 12W
(1000lm, 4000K) incl.
IP20 • 19828
chrome/transparent

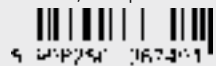

5 362250 367301

6750 (M) (P) (G)

☒ LED / 18W
(1400lm, 4000K) incl.
IP20 • 19829
chrome/transparent



5 362250 367507

EASY LIGHT

WARM White



2361

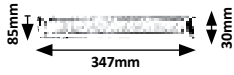

2362

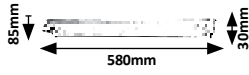

2363

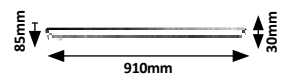

2364

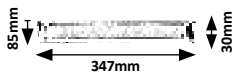

2365

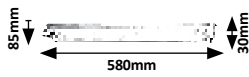

2366

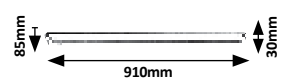

illustration

2361

M G

8W
(480lm, 2700K) incl.
G5 / T5 / 1x max. 8W
IP20 • • white



S 36225C 2276210

2362

M G

13W
(820lm, 2700K) incl.
G5 / T5 / 1x max. 13W
IP20 • • white



S 36225C 2276220

2363

M G

21W
(1890lm, 2700K) incl.
G5 / T5 / 1x max. 21W
IP20 • • white



S 36225C 2276233

2364

M G

8W
(480lm, 2700K) incl.
G5 / T5 / 1x max. 8W
IP20 • • silver



S 36225C 2276240

2365

M G

13W
(820lm, 2700K) incl.
G5 / T5 / 1x max. 13W
IP20 • • silver



S 36225C 2276277

2366

M G

21W
(1890lm, 2700K) incl.
G5 / T5 / 1x max. 21W
IP20 • • silver



S 36225C 2276284

SLIM

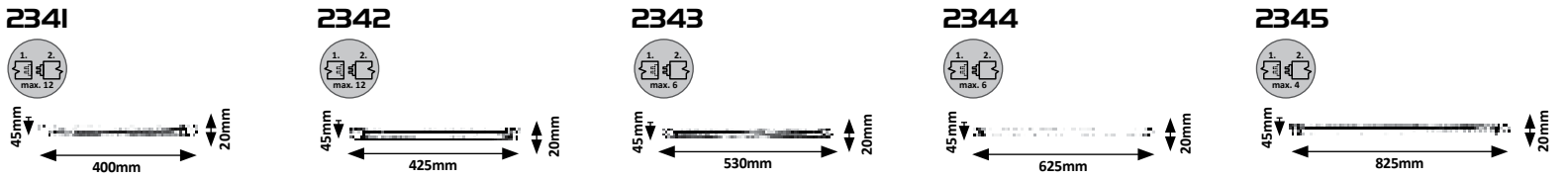
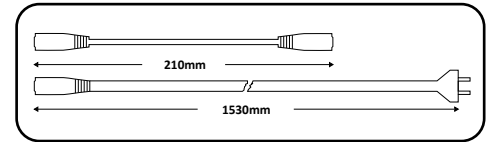

illustration

2341



8W (520lm, 2700K) incl.
G5 / T4 / 1x max. 8W
IP20 • white



2342



12W (850lm, 2700K) incl.
G5 / T4 / 1x max. 12W
IP20 • white



2343



16W (1230lm, 2700K) incl.
G5 / T4 / 1x max. 16W
IP20 • white



2344



20W (1500lm, 2700K) incl.
G5 / T4 / 1x max. 20W
IP20 • white



2345



30W (2500lm, 2700K) incl.
G5 / T4 / 1x max. 30W
IP20 • white



DUDDU

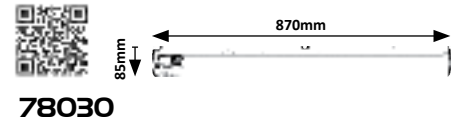
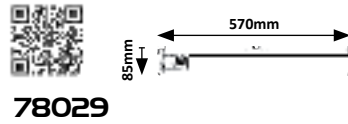
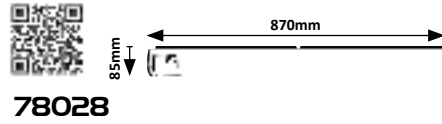
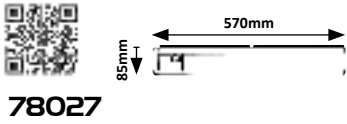

78027 (M) (P)

LED / 17W
 (1020lm, 1700lm;
 4000K) incl. • IP44
 white



78028 (M) (P)

LED / 20W
 (1200lm, 2000lm;
 4000K) incl. • IP44
 white



78029 (M) (P)

LED / 17W
 (1020lm, 1700lm;
 4000K) incl. • IP44
 black/white



78030 (M) (P)

LED / 20W
 (1200lm, 2000lm;
 4000K) incl. • IP44
 black/white



BATH



2321



2322

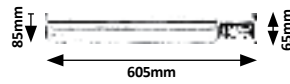

2323

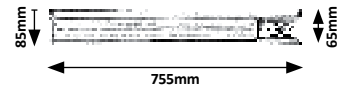

illustration

2321 (M P)

11W (840lm, 2700K) incl.
G23 / PL / 1x max. 11W
IP20 • 
white



2322 (M P)

15W (950lm, 2700K) incl.
G13 / T8 / 1x max. 15W
IP20 • 
white



2323 (M P)

18W (1350lm, 2700K) incl.
G13 / T8 / 1x max. 18W
IP20 • 
white



SOFT



2326

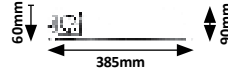

2327



2328



2329

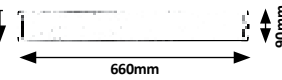

2326



11W (840lm, 2700K) incl.
G23 / PL / 1x max. 11W
IP20 • •
silver



S 362250 223206

2327



18W (1350lm, 2700K) incl.
G13 / T8 / 1x max. 18W
IP20 • •
silver



S 362250 223207

2328



10W (630lm, 2700K) incl.
G13 / T8 / 1x max. 10W
IP20 • •
silver



S 362250 223202

2329



18W (1350lm, 2700K) incl.
G13 / T8 / 1x max. 18W
IP20 • •
silver



S 362250 223200

BATTEN LIGHT

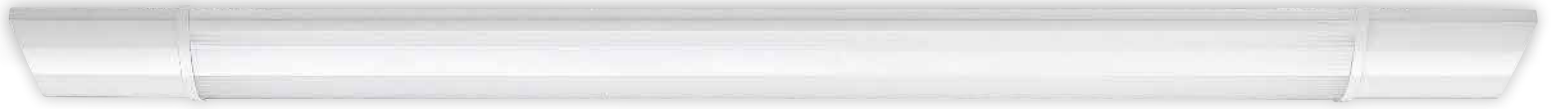

I450



I451



I452



I453



illustration

I450



LED / 10W
(800lm, 4000K) incl.
IP20
white



S 36225C 314501

I451



LED / 20W
(1600lm, 4000K) incl.
IP20
white



S 36225C 314516

I452



LED / 30W
(2400lm, 4000K) incl.
IP20
white



S 36225C 314525

I453



LED / 40W
(3200lm, 4000K) incl.
IP20
white



S 36225C 314532

HANSON

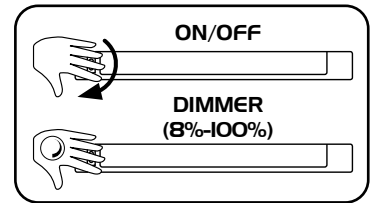

5674

NATURAL White

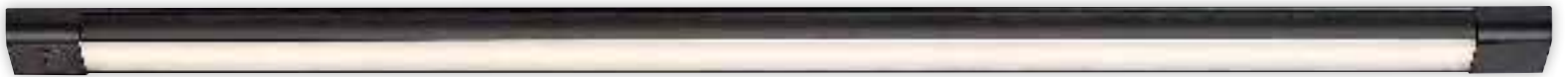
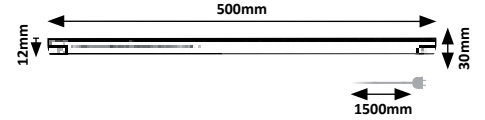

New



78026

WARM White



illustration

5674 (P)

LED / 8W
(560lm, 4000K) incl.
IP20 • 120°
grey/white



5 902250 036747

78026 (P)

LED / 8W
(570lm, 600lm;
3000K) incl. • 0,05m, 120°
IP20 • black/white



4 702250 287026

GREG



5216



5217



5218

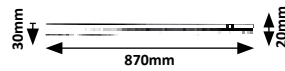

5219

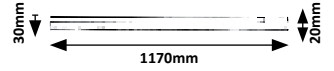

illustration

5216

(P)

LED / 4W
(400lm, 4000K) incl.
IP20 •
white



5 908250 352100

5217

(P)

LED / 9W
(900lm, 4000K) incl.
IP20 •
white

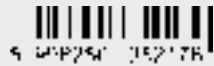

5 908250 352175

5218

(P)

LED / 13W
(1300lm, 4000K) incl.
IP20 •
white

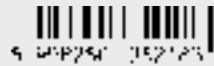

5 908250 352185

5219

(P)

LED / 18W
(1865lm, 4000K) incl.
IP20 •
white



5 908250 352190

GREG



78003

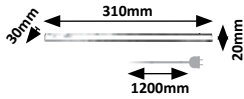

78004

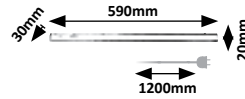

78005

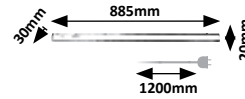

78006

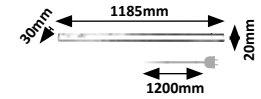

illustration

78003



LED / 4W
 (3390lm, 5330lm;
 4000K) incl. • IP20
 black/white



= 474294 78003

78004



LED / 9W
 (860lm, 1190lm;
 4000K) incl. • IP20
 black/white



= 474294 78004

78005



LED / 13W
 (1220lm, 1690lm;
 4000K) incl. • IP20
 black/white



= 474294 78005

78006



LED / 18W
 (1580lm, 2250lm;
 4000K) incl. • IP20
 black/white



= 474294 78006

BAND LIGHT



2301

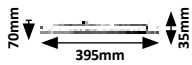

2302

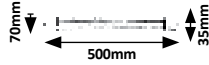

2303

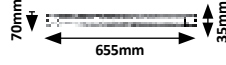

2304

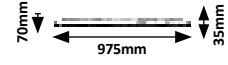

2305



illustration

2301 (M P)

10W (630lm, 2700K) incl.
G13 / T8 / 1x max. 10W
IP20 • 19685
white



S 36R25C 023C13

2302 (M P)

15W (950lm, 2700K) incl.
G13 / T8 / 1x max. 15W
IP20 • 19686
white



S 36R25C 023C22

2303 (M P)

18W (1380lm, 2700K) incl.
G13 / T8 / 1x max. 18W
IP20 • 19687
white



S 36R25C 023C30

2304 (M P)

30W (2400lm, 2700K) incl.
G13 / T8 / 1x max. 30W
IP20 • 19688
white



S 36R25C 023C40

2305 (M P)

36W (3350lm, 2700K) incl.
G13 / T8 / 1x max. 36W
IP20 • 19689
white



S 36R25C 023C53

BAND LIGHT



2306

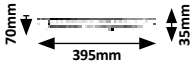

2307

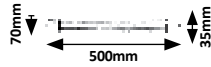

2308

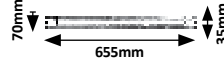

2309



illustration

2306 (M) (P)

10W (630lm, 2700K) incl.
G13 / T8 / 1x max. 10W
IP20 • • • 19685
silver



5 362250 123200

2307 (M) (P)

15W (950lm, 2700K) incl.
G13 / T8 / 1x max. 15W
IP20 • • • 19686
silver



5 362250 123207

2308 (M) (P)

18W (1350lm, 2700K) incl.
G13 / T8 / 1x max. 18W
IP20 • • • 19687
silver



5 362250 123208

2309 (M) (P)

36W (3350lm, 2700K) incl.
G13 / T8 / 1x max. 36W
IP20 • • • 19689
silver



5 362250 123209

08

**RECESSED AND SURFACE
MOUNTED LIGHTING**

BE- ÉS RÁÉPÍTHETŐ LÁMPÁK

EIN- UND AUFBAULEUCHTEN





SHAUN

5 YEARS GUARANTEE

LED built-in

NATURAL White

F A ↑ G

New



2678



Ø 95mm



2679



Ø 145mm



2680



Ø 170mm



2681



Ø 220mm

2678

P

LED / 5W
(450lm, 4000K) incl.
IP20 • 26mm
black/white



2679

P

LED / 12W
(1035lm, 4000K) incl.
IP20 • 26mm
black/white



2680

P

LED / 17W
(1500lm, 4000K) incl.
IP20 • 26mm
black/white



2681

P

LED / 24W
(2300lm, 4000K) incl.
IP20 • 26mm
black/white



SHAUN



2682

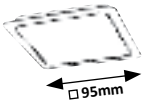

2683

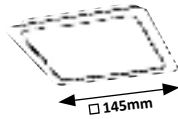

2684

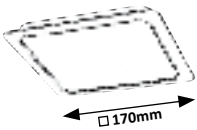

2685

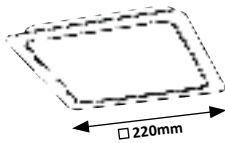

2682



LED / 5W
(450lm, 4000K) incl.
IP20 • 26mm
black/white



2683



LED / 12W
(1035lm, 4000K) incl.
IP20 • 26mm
black/white



2684



LED / 17W
(1500lm, 4000K) incl.
IP20 • 26mm
black/white



2685



LED / 24W
(2300lm, 4000K) incl.
IP20 • 26mm
black/white



SHAUN



3163

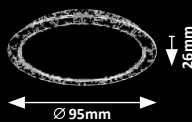

3165

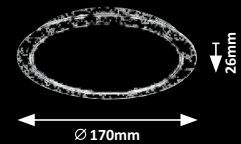

3164

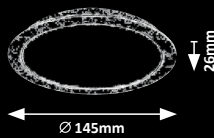

3166

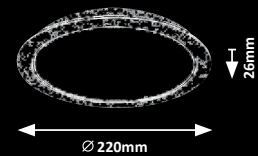

3163

(P)

LED / 5W
(450lm, 4000K) incl.
IP20 • 26mm
white



3164

(P)

LED / 12W
(1300lm, 4000K) incl.
IP20 • 26mm
white



3165

(P)

LED / 18W
(1845lm, 4000K) incl.
IP20 • 26mm
white



3166

(P)

LED / 24W
(2400lm, 4000K) incl.
IP20 • 26mm
white



SHAUN



3167

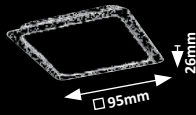

3169

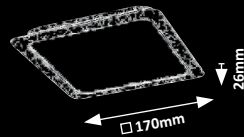

3168

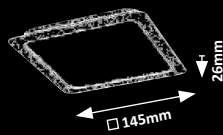

3170

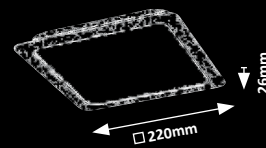

3167

(P)

LED / 5W
(450lm, 4000K) incl.
IP20 • 26mm
white



5 362250 331270

3168

(P)

LED / 12W
(1300lm, 4000K) incl.
IP20 • 26mm
white



5 362250 331283

3169

(P)

LED / 18W
(1845lm, 4000K) incl.
IP20 • 26mm
white



5 362250 331290

3170

(P)

LED / 24W
(2400lm, 4000K) incl.
IP20 • 26mm
white



5 362250 331700



SHAUN



2686

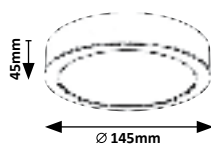

2687

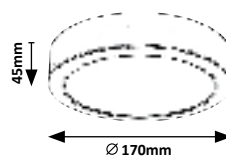

2688

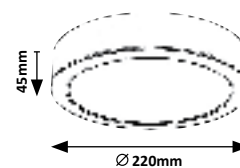

2689

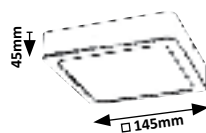

2690

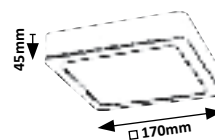

2691

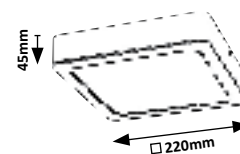

2686



LED / 12W
(1035lm, 4000K) incl.
IP20
black/white



2687



LED / 17W
(1500lm, 4000K) incl.
IP20
black/white



2688



LED / 24W
(2300lm, 4000K) incl.
IP20
black/white



2689



LED / 12W
(1035lm, 4000K) incl.
IP20
black/white



2690



LED / 17W
(1500lm, 4000K) incl.
IP20
black/white



2691



LED / 24W
(2300lm, 4000K) incl.
IP20
black/white



SHAUN



3171

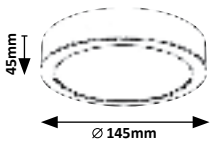

3172

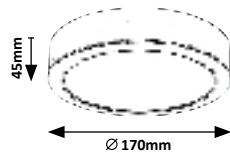

3173

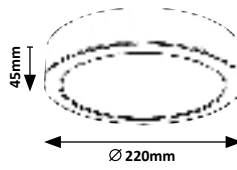

3174

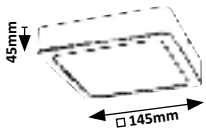

3175

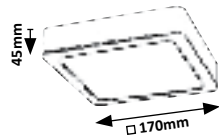

3176

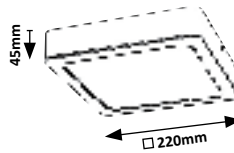

3171



LED / 12W
(1300lm, 4000K) incl.
IP20
white



3172



LED / 18W
(1845lm, 4000K) incl.
IP20
white



3173



LED / 24W
(2400lm, 4000K) incl.
IP20
white



3174



LED / 12W
(1300lm, 4000K) incl.
IP20
white



3175



LED / 18W
(1845lm, 4000K) incl.
IP20
white



3176



LED / 24W
(2400lm, 4000K) incl.
IP20
white



KOBALD



2047

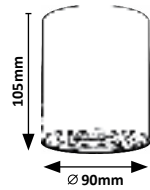

2048

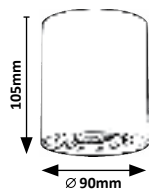

2049

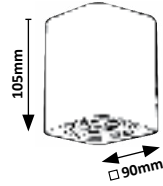

2050

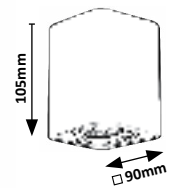

2047 (M)
 ☒ GU10 / 1x max. 42W
 IP20
 matte black



2048 (M)
 ☒ GU10 / 1x max. 42W
 IP20
 matte white



2049 (M)
 ☒ GU10 / 1x max. 42W
 IP20
 matte black



2050 (M)
 ☒ GU10 / 1x max. 42W
 IP20
 matte white



KOBALD



2051 **(M)**
 ☒ GU10 / 2x max. 42W
 IP20
 matte black



S 36R25C 220510

2052 **(M)**
 ☒ GU10 / 2x max. 42W
 IP20
 matte white



S 36R25C 220520

2053 **(M)**
 ☒ GU10 / 2x max. 42W
 IP20
 matte black



S 36R25C 220533

2054 **(M)**
 ☒ GU10 / 2x max. 42W
 IP20
 matte white



S 36R25C 220540

2055 **(M)**
 ☒ E27 / G45 / 1x max. 25W
 IP20
 matte black



S 36R25C 220557

2056 **(M)**
 ☒ E27 / G45 / 1x max. 25W
 IP20
 matte white



S 36R25C 220564

71001, 71002



DONALD



2484



2485



MADDOX



2486

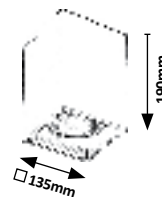

2487

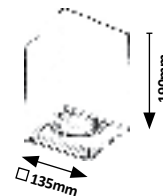

2484



☒ E27 / 1x max. 60W
IP20
matte white



S 398290 324845

2485



☒ E27 / 1x max. 60W
IP20
grey



S 398290 324852

2486



☒ E27 / 1x max. 60W
IP20
matte white



S 398290 324860

2487



☒ E27 / 1x max. 60W
IP20
grey



S 398290 324870

FARAMIR



New

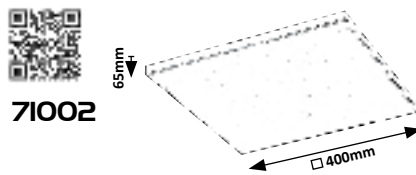
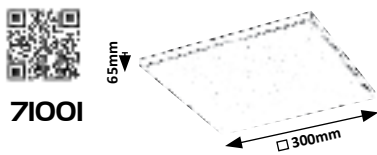

SONNET

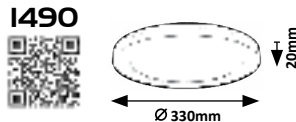
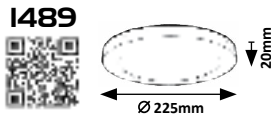

I489, I490

Surface mounted • Ráépíthető • Aufbau



Recessed • Beépíthető • Einbau



2in1

Movable spring
Állítható beépítési méret
Bewegliche Feder

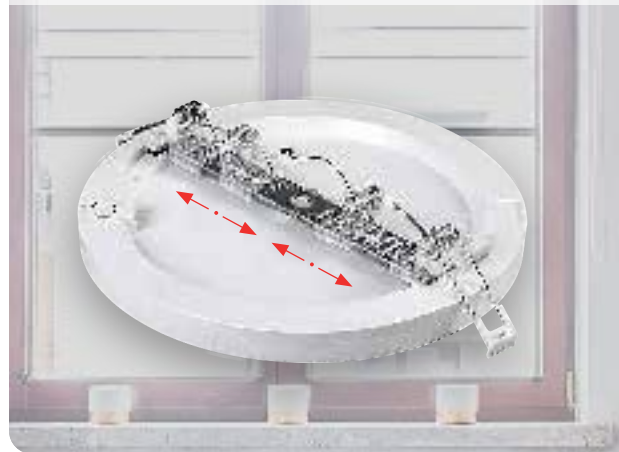

71001 (M) (P)

LED / 18W
(1400lm, 1800lm;
3000K-6500K) incl.
IP20 • 541 • white



4 742 94 7 7020

71002 (M) (P)

LED / 24W
(1880lm, 2400lm;
3000K-6500K) incl.
IP20 • 541 • white



4 742 94 7 7020

I489 (M) (P)

LED / 18W
(1880lm, 4000K) incl.
IP20 • white
65-205mm • 70mm



5 362250 314891

I490 (M) (P)

LED / 30W
(2800lm, 4000K) incl.
IP20 • white
65-305mm • 70mm



5 362250 314907

OLEG



5371

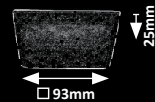

5373

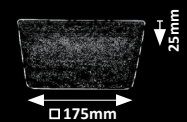

5372

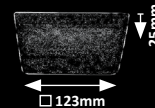

5374

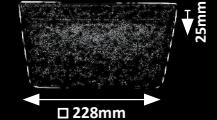

5371 (M) (P)

LED / 7W
(714lm, 4000K) incl.
IP65/IP20 • white
75mm

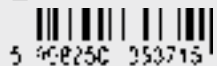

5 408250 353713

5372 (M) (P)

LED / 12W
(1272lm, 4000K) incl.
IP65/IP20 • white
125mm

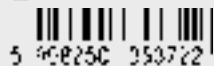

5 408250 353722

5373 (M) (P)

LED / 18W
(1890lm, 4000K) incl.
IP65/IP20 • white
185mm



5 408250 353719

5374 (M) (P)

LED / 24W
(2568lm, 4000K) incl.
IP65/IP20 • white
245mm

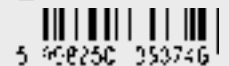

5 408250 353746

OLEG



5367

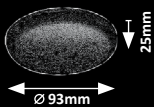

5369

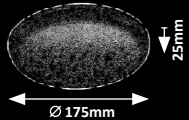

5368

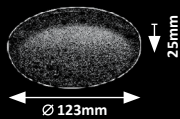

5370

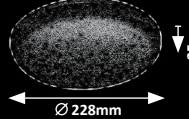

5367 (M P)

LED / 7W
(714lm, 4000K) incl.
IP65/IP20 • white
73mm

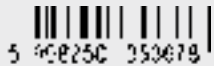

5368 (M P)

LED / 12W
(1272lm, 4000K) incl.
IP65/IP20 • white
107mm

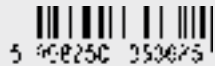

5369 (M P)

LED / 18W
(1890lm, 4000K) incl.
IP65/IP20 • white
140mm



5370 (M P)

LED / 24W
(2568lm, 4000K) incl.
IP65/IP20 • white
205mm

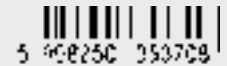

LOIS



5568

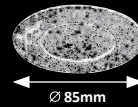

5570

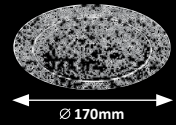

5569

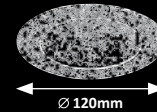

5571

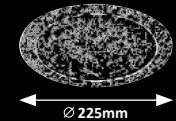

5568 (MP)

LED / 3W
(170lm, 4000K) incl.
IP20 • matte white
76mm • 25mm



S 36225C 355220

5569 (MP)

LED / 6W
(350lm, 4000K) incl.
IP20 • matte white
106mm • 25mm



S 36225C 355290

5570 (MP)

LED / 12W
(800lm, 4000K) incl.
IP20 • matte white
155mm • 25mm



S 36225C 355702

5571 (MP)

LED / 18W
(1400lm, 4000K) incl.
IP20 • matte white
210mm • 25mm



S 36225C 355710

LOIS



5576

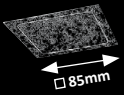

85mm

5578

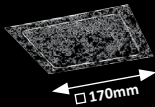

170mm

5577

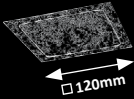

120mm

5579

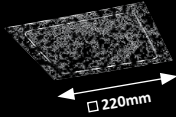

220mm



5576 (MP)

LED / 3W
(170lm, 4000K) incl.
IP20 • matte white

70mm • 25mm



S 362260 755704

5577 (MP)

LED / 6W
(350lm, 4000K) incl.
IP20 • matte white

106mm • 25mm



S 362260 755711

5578 (MP)

LED / 12W
(800lm, 4000K) incl.
IP20 • matte white

155mm • 25mm



S 362260 755728

5579 (MP)

LED / 18W
(1400lm, 4000K) incl.
IP20 • matte white

205mm • 25mm



S 362260 755790

LOIS



2663

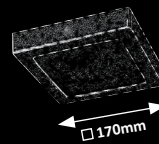

2664

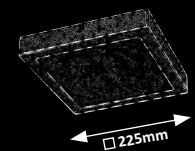

2665

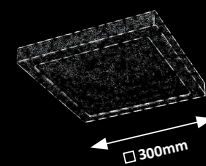

2666

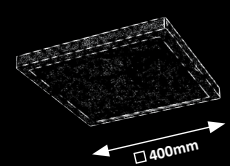

2663 (M) (P)

LED / 12W
(800lm, 4000K) incl.
IP20
matte white



S 36R29C 020274

2664 (M) (P)

LED / 18W
(1400lm, 4000K) incl.
IP20
matte white



S 36R29C 020281

2665 (M) (P)

LED / 24W
(1700lm, 4000K) incl.
IP20
matte white



S 36R29C 020276

2666 (M) (P)

LED / 36W
(2500lm, 4000K) incl.
IP20
matte white



S 36R29C 020275

LOIS

5
YEAR
WARRANTY

LED
built-in

NATURAL
White



2655

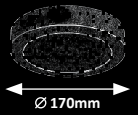

Ø 170mm

2657

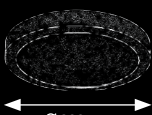

Ø 300mm

2656

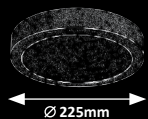

Ø 225mm

2658

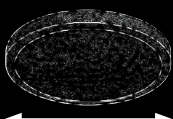

Ø 400mm



2655

MP

LED / 12W
(800lm, 4000K) incl.
IP20
matte white



5 362250 320510

2656

MP

LED / 18W
(1400lm, 4000K) incl.
IP20
matte white



5 362250 320510

2657

MP

LED / 24W
(1700lm, 4000K) incl.
IP20
matte white



5 362250 320513

2658

MP

LED / 36W
(2500lm, 4000K) incl.
IP20
matte white



5 362250 320520

LOIS



5584

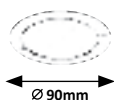

5585

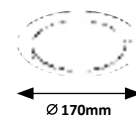

5586

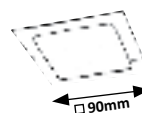

5587

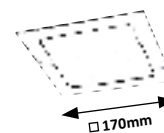

5584 (M) (P)

LED / 3W
(170lm, 4000K) incl.
IP44 • chrome/white
76mm • 30mm



S 362250 355840

5585 (M) (P)

LED / 12W
(800lm, 4000K) incl.
IP44 • chrome/white
155mm • 30mm



S 362250 355850

5586 (M) (P)

LED / 3W
(170lm, 4000K) incl.
IP44 • chrome/white
76mm • 30mm



S 362250 355863

5587 (M) (P)

LED / 12W
(800lm, 4000K) incl.
IP44 • chrome/white
155mm • 25mm



S 362250 355870

RANDY

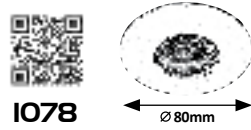
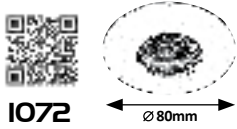

SPOT FASHION

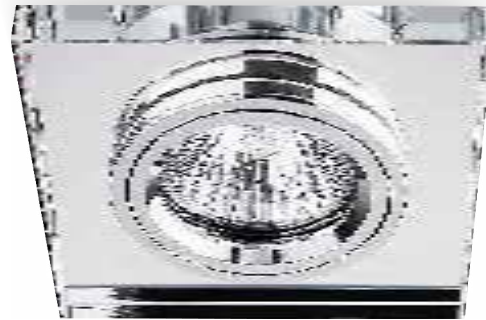
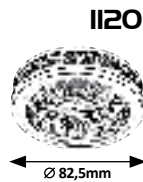

1072

(P)

LED / 4W
(350lm, 3000K) incl.
IP20/IP44 • chrome
68mm • 40mm



5 362250 310725

1078

(P)

LED / 4W
(350lm, 3000K) incl.
IP20/IP44 • white
68mm • 40mm



5 362250 310727

1079

(P)

LED / 4W
(350lm, 3000K) incl.
IP20/IP44 • chrome
68mm • 40mm



5 362250 310794

1080

(P)

LED / 4W
(350lm, 3000K) incl.
IP20/IP44 • white
68mm • 40mm



5 362250 310800

1120

(M) (AC)

GU 5.3 / 12V /
1x max. 50W
IP20 • transparent
60mm • 25mm



5 362250 311203

1147

(M) (G)

GU 5.3 / 12V /
1x max. 50W
IP20 • chrome
60mm • 30mm



5 362250 311470



LITE

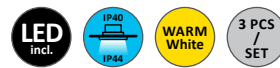

I046

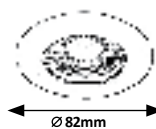

I047

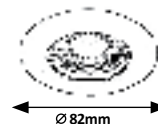

I048

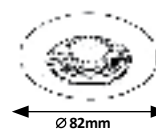

I163

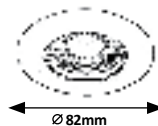

I046



LED / 3W (240lm, 3000K) incl.
GU10 / 1x max. 50W
IP44/IP40 • white

68mm • 65mm



5 362250 310400

I047



LED / 3W (240lm, 3000K) incl.
GU10 / 1x max. 50W
IP44/IP40 • chrome

68mm • 65mm



5 362250 310403

I048



LED / 3W (240lm, 3000K) incl.
GU10 / 1x max. 50W
IP44/IP40 • bronze

68mm • 65mm



5 362250 310402

I163



LED / 3W (240lm, 3000K) incl.
GU10 / 1x max. 50W
IP44/IP40 • satin chrome

68mm • 65mm



5 362250 311630

LITE



1049

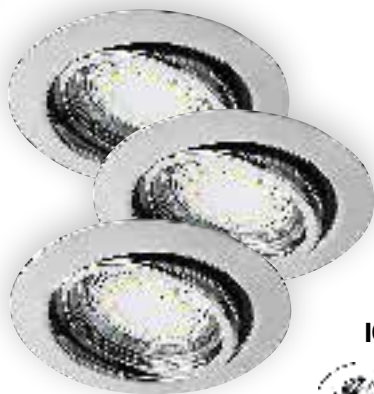
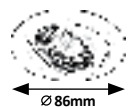

1050

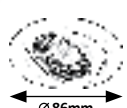

1051

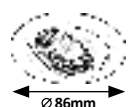

1166

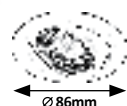

1049



LED / 3W (240lm, 3000K) incl.
GU10 / 1x max. 50W
IP40 • white

72mm • 60mm



S 36225C 310297

1050



LED / 3W (240lm, 3000K) incl.
GU10 / 1x max. 50W
IP40 • chrome

72mm • 60mm



S 36225C 310263

1051



LED / 3W (240lm, 3000K) incl.
GU10 / 1x max. 50W
IP40 • bronze

72mm • 60mm



S 36225C 310510

1166



LED / 3W (240lm, 3000K) incl.
GU10 / 1x max. 50W
IP40 • satin chrome

72mm • 65mm



S 36225C 311201

SPOT RELIGHT



I088

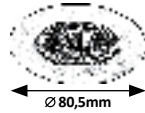

I090

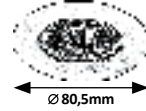

I087

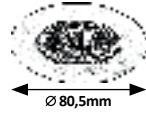

I089

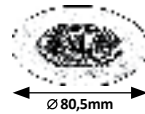

2150

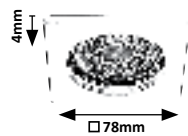

2151

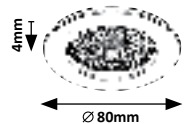

I087



☒ GU 5.3 / 12V /
1x max. 50W
IP20 • white
☒ 68mm • ↓ 35mm



S 392250 210870

I088



☒ GU 5.3 / 12V /
1x max. 50W
IP20 • chrome
☒ 68mm • ↓ 35mm



S 392250 210880

I089



☒ GU 5.3 / 12V /
1x max. 50W
IP20 • satin chrome
☒ 68mm • ↓ 35mm



S 392250 210890

I090



☒ GU 5.3 / 12V /
1x max. 50W
IP20 • bronze
☒ 68mm • ↓ 35mm



S 392250 210900

2150



☒ GU 5.3 / 1x max. 25W
IP20
black
☒ 58mm • ↓ 26mm



S 038250 215000

2151



☒ GU 5.3 / 1x max. 25W
IP20
black
☒ 58mm • ↓ 26mm



S 038250 215100

SPOT RELIGHT



1091

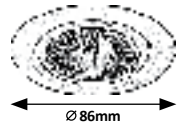

1092

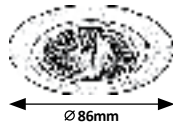

1093

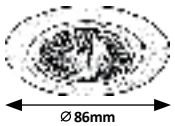

1095

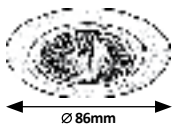

1091



☒ GU 5.3 / 12V / 1x max. 50W
IP20 • white
☒ 72mm • ↓ 35mm



1092



☒ GU 5.3 / 12V / 1x max. 50W
IP20 • chrome
☒ 72mm • ↓ 35mm



1093



☒ GU 5.3 / 12V / 1x max. 50W
IP20 • satin chrome
☒ 72mm • ↓ 35mm



1095



☒ GU 5.3 / 12V / 1x max. 50W
IP20 • bronze
☒ 72mm • ↓ 35mm



09

OUTDOOR LAMPS

KÜLTÉRI LÁMPÁK

AUSSENLEUCHTEN



WALES



New



7195

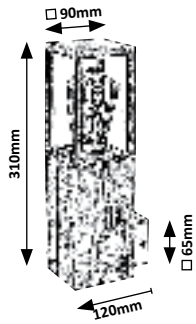

7196



7197

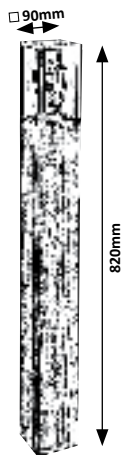

7195 (M) (G)

⊗ E27 / 1x max. 60W
IP44 • 19271
oak/transparent/black



7196 (M) (G)

⊗ E27 / 1x max. 60W
IP44 • 19271
oak/transparent/black



7197 (M) (G)

⊗ E27 / 1x max. 60W
IP44 • 19271
oak/transparent/black



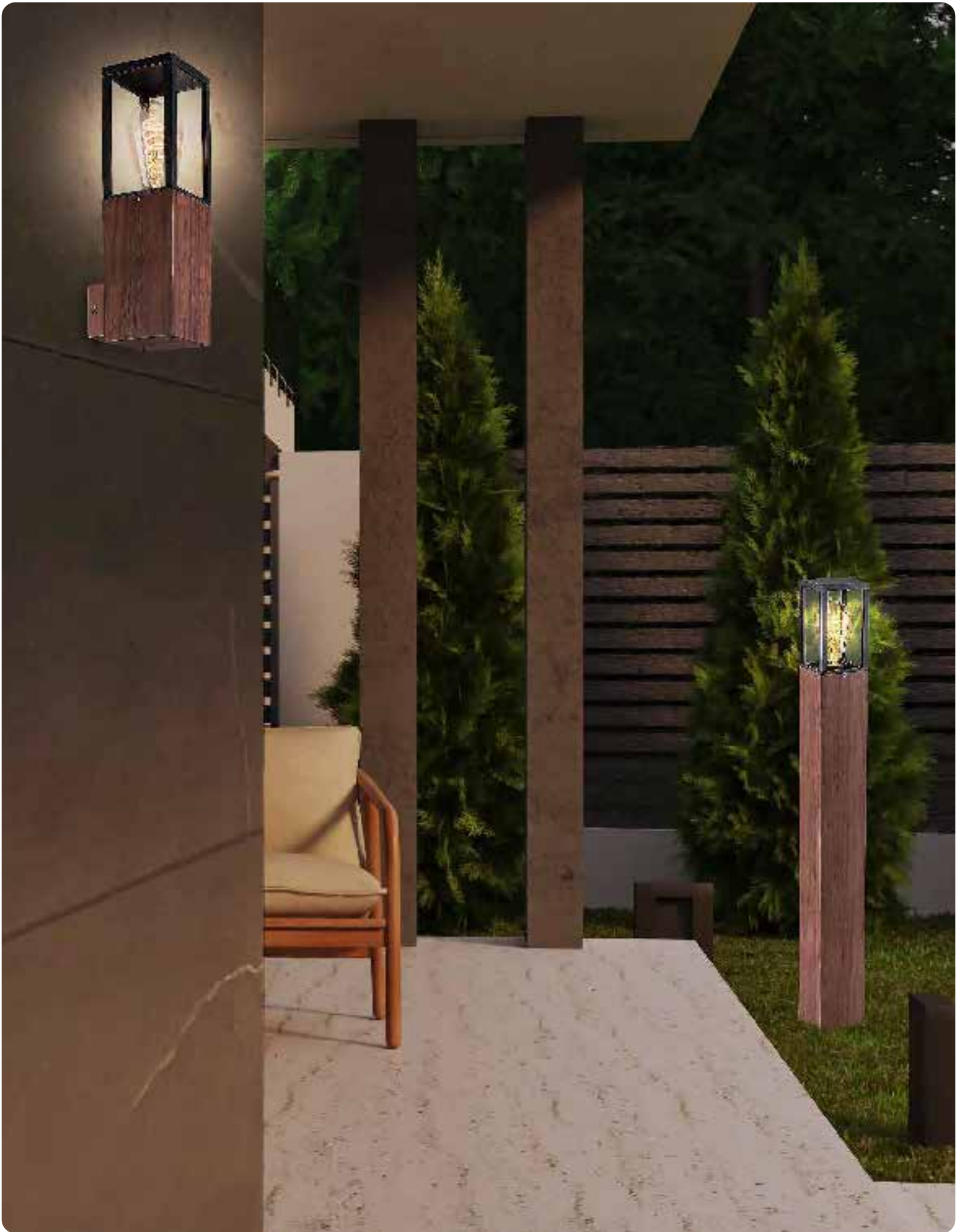



KOLTA



New



7386

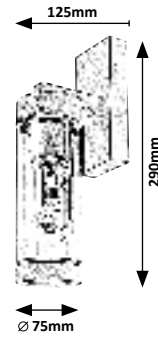

7387

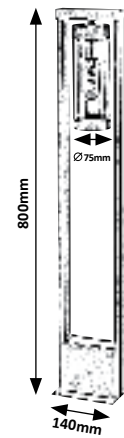

7386 (M) (P)

☒ E27 / 1x max. 12W
 IP44 • 19150
 matte black/transparent



7387 (M) (P)

☒ E27 / 1x max. 12W
 IP44 • 19150
 matte black/transparent



SAVANO



New



7266

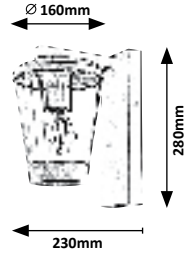

7268

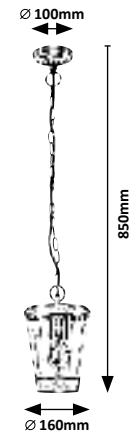

7269

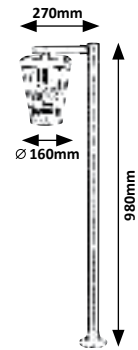

7267

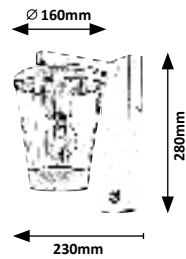

7266 (M) (P)

☒ E27 / 1x max. 40W
IP44 • 19178
anthracite/transparent



7267 (M) (P)

☒ E27 / 1x max. 40W
IP44 • 19178
☒ 8±2m, 120°
anthracite/transparent



7268 (M) (P)

☒ E27 / 1x max. 40W
IP44 • 19178
anthracite/transparent



7269 (M) (P)

☒ E27 / 1x max. 40W
IP44 • 19178
anthracite/transparent



PARAVENTO



New



7146

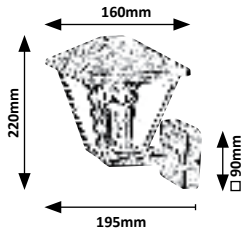

7147

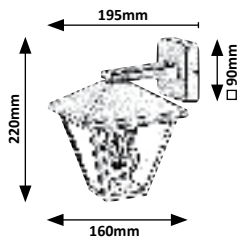

7148

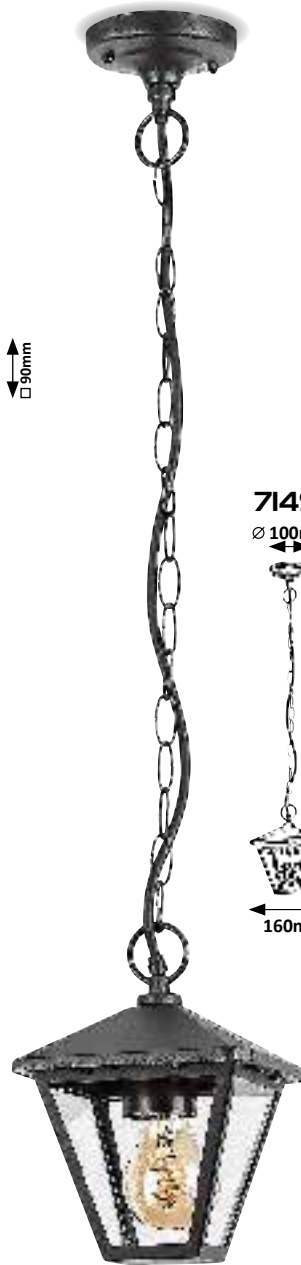

7149



7150

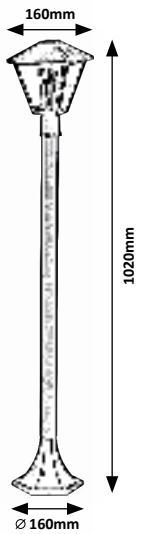

7146 (M) (G)

☒ E27 / 1x max. 40W
IP44 • 19275
black/transparent



7147 (M) (G)

☒ E27 / 1x max. 40W
IP44 • 19275
black/transparent



7148 (M) (G)

☒ E27 / 1x max. 40W
IP44 • 19275
black/transparent



7149 (M) (G)

☒ E27 / 1x max. 40W
IP44 • 19275
black/transparent



7150 (M) (G)

☒ E27 / 1x max. 40W
IP44 • 19275
black/transparent



TAVERNA

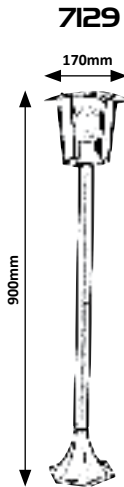
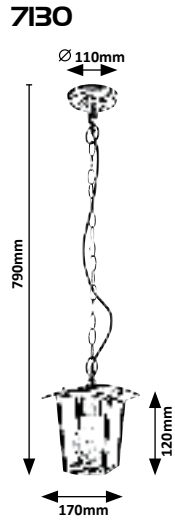
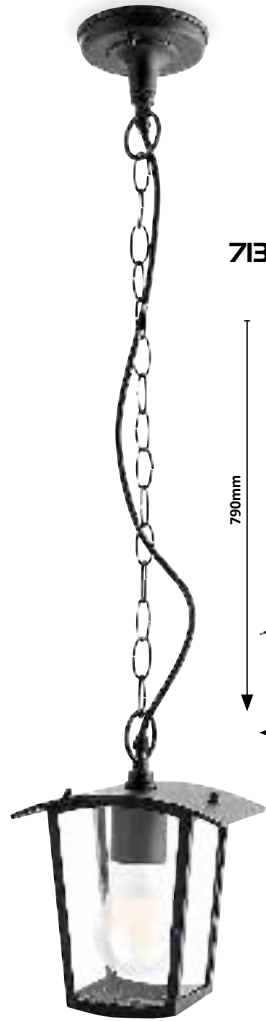
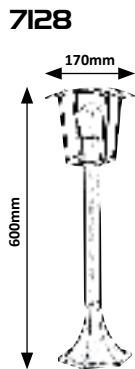
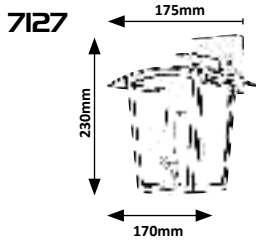

7127 (M) (P)

☒ E27 / 1x max. 15W
IP44 • 19983
black/transparent



7128 (M) (P)

☒ E27 / 1x max. 15W
IP44 • 19983
black/transparent



7129 (M) (P)

☒ E27 / 1x max. 15W
IP44 • 19983
black/transparent



7130 (M) (P)

☒ E27 / 1x max. 15W
IP44 • 19983
black/transparent



DUBROVNIK



New

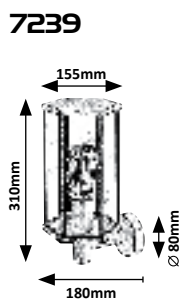
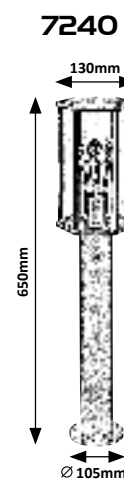
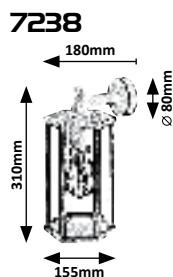

7238 (M) (G)

☒ E27 / 1x max. 40W
IP44 • 19166
matte black/transparent



7239 (M) (G)

☒ E27 / 1x max. 40W
IP44 • 19166
matte black/transparent



7240 (M) (G)

☒ E27 / 1x max. 40W
IP44 • 19166
matte black/transparent





BUDAPEST



8888

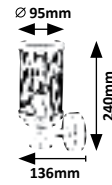

8890



8889



8888 (M) (P)

☒ E27 / 1x max. 40W
IP44
brown/transparent



8889 (M) (P)

☒ E27 / 1x max. 40W
IP44
brown/transparent

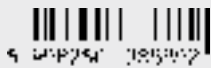

8890 (M) (P)

☒ E27 / 1x max. 40W
IP44
brown/transparent

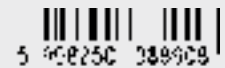

ALMADA



7884

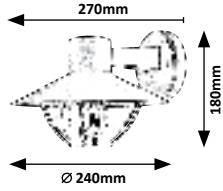

7886

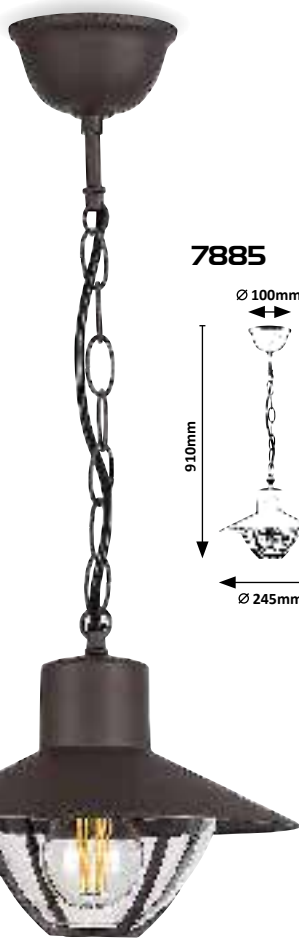
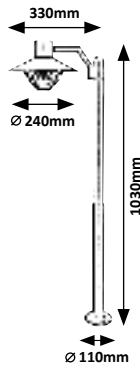

7885

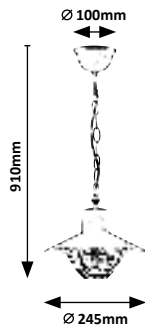

7884 (M) (P)

☒ E27 / 1x max. 10W
IP44 • 19855
brown/transparent

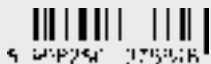

7885 (M) (P)

☒ E27 / 1x max. 10W
IP44 • 19855
brown/transparent



7886 (M) (P)

☒ E27 / 1x max. 10W
IP44 • 19855
brown/transparent

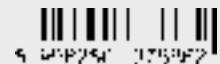

MONACO

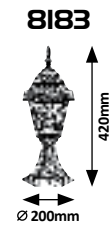
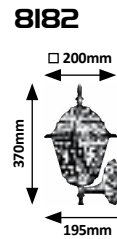
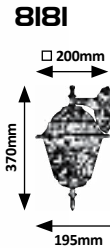

8181 **MG**
☒ E27 / 1x max. 60W
IP43 • 19053
antique gold/multicolour



5 392250 32187

8182 **MG**
☒ E27 / 1x max. 60W
IP43 • 19053
antique gold/multicolour



5 392250 321824

8183 **MG**
☒ E27 / 1x max. 60W
IP43 • 19053
antique gold/multicolour



5 392250 321831

MONACO



8184

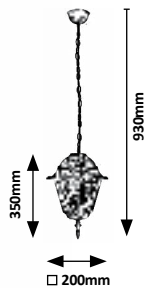

8185

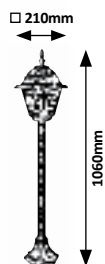

8186

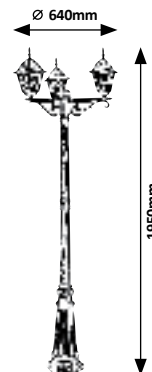

8184 **MG**

☒ E27 / 1x max. 60W
IP43 • 19053
antique gold/multicolour



5 362250 321872

8185 **MG**

☒ E27 / 1x max. 60W
IP43 • 19053
antique gold/multicolour



5 362250 321873

8186 **MG**

☒ E27 / 3x max. 60W
IP43 • 19053
antique gold/multicolour



5 362250 321872



8380

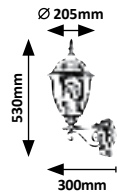

8381

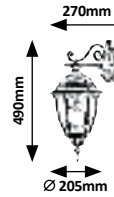

8382

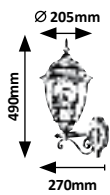

8383

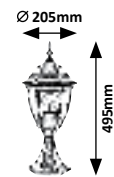

8380 (M) (G)

☒ E27 / 1x max. 60W
IP44 • 9801
8m, 100°
antique gold/transparent



5 362250 323804

8381 (M) (G)

☒ E27 / 1x max. 60W
IP44 • 9801
antique gold/transparent



5 362250 323811

8382 (M) (G)

☒ E27 / 1x max. 60W
IP44 • 9801
antique gold/transparent



5 362250 323828

8383 (M) (G)

☒ E27 / 1x max. 60W
IP44 • 9801
antique gold/transparent



5 362250 323835

TORONTO

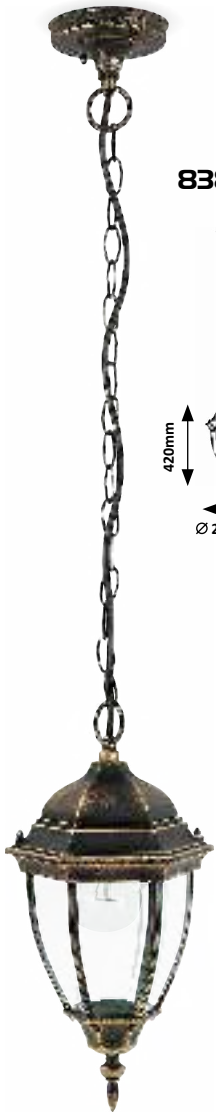

8384

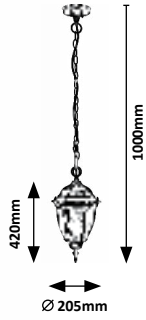

8385

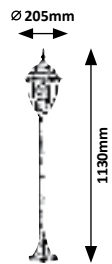

8460

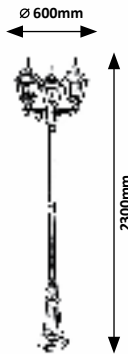

8384 **(M G)**

☒ E27 / 1x max. 60W
IP44 • 9801
antique gold/transparent



5 362250 323842

8385 **(M G)**

☒ E27 / 1x max. 60W
IP44 • 9801
antique gold/transparent



5 362250 323850

8460 **(M G)**

☒ E27 / 3x max. 60W
IP44 • 9801
antique gold/transparent



5 362250 324603

NIZZA



8451

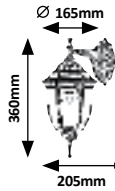

8452

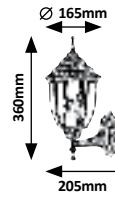

8453

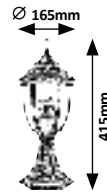

8454

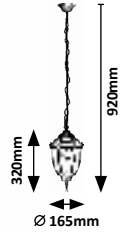

8458

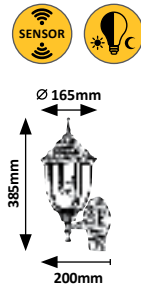

8455



8451 (MG)

☒ E27 / 1x max. 60W
IP43 • 9837
antique gold/transparent



8452 (MG)

☒ E27 / 1x max. 60W
IP43 • 9837
antique gold/transparent



8453 (MG)

☒ E27 / 1x max. 60W
IP43 • 9837
antique gold/transparent



8454 (MG)

☒ E27 / 1x max. 60W
IP43 • 9837
antique gold/transparent



8455 (MG)

☒ E27 / 1x max. 60W
IP43 • 9837
antique gold/transparent



8458 (MG)

☒ E27 / 1x max. 60W
IP43 • 9837
8m, 120°
antique gold/transparent





TOSCANA



8396

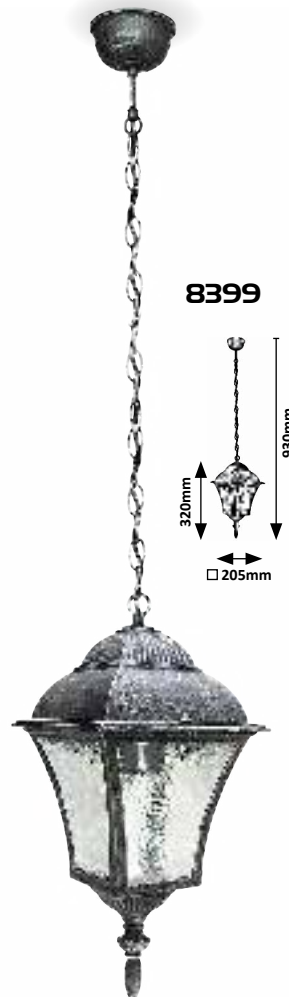
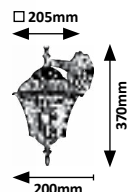

8399

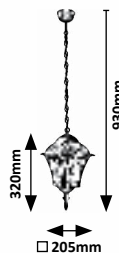

8397

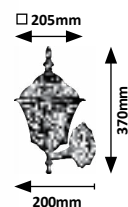

8398

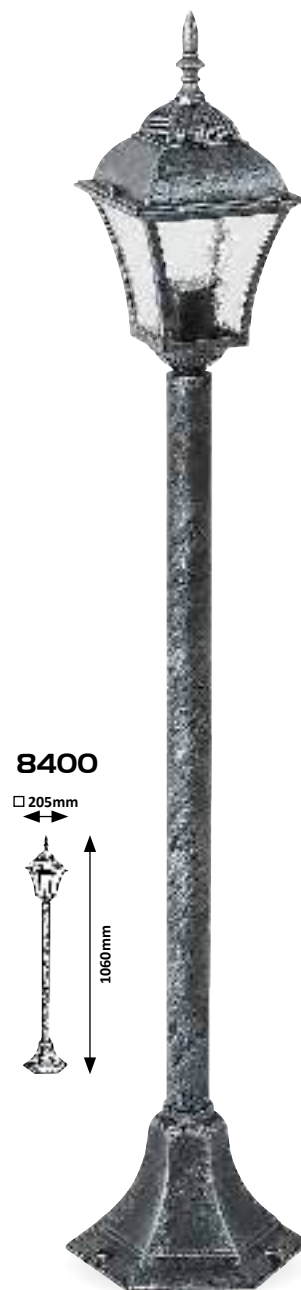
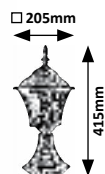

8400

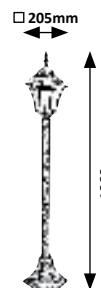

8396 **MG**

☒ E27 / 1x max. 60W
IP43 • 19052
antique silver/transparent



8397 **MG**

☒ E27 / 1x max. 60W
IP43 • 19052
antique silver/transparent



8398 **MG**

☒ E27 / 1x max. 60W
IP43 • 19052
antique silver/transparent



8399 **MG**

☒ E27 / 1x max. 60W
IP43 • 19052
antique silver/transparent



8400 **MG**

☒ E27 / 1x max. 60W
IP43 • 19052
antique silver/transparent



TOSCANA

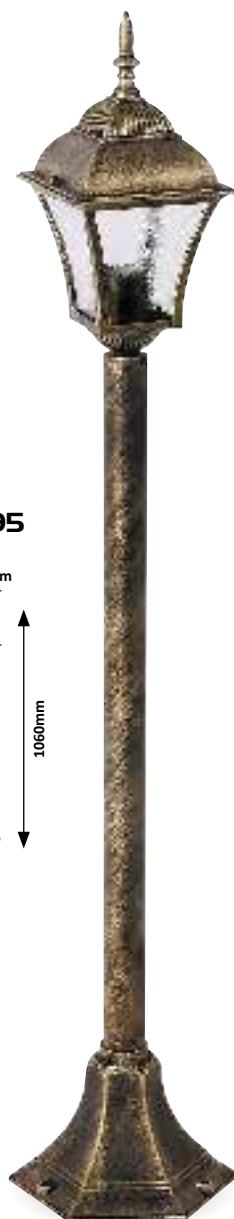

8391 **MG**
 ☒ E27 / 1x max. 60W
 IP43 • 19052
 antique gold/transparent



5 362250 283270

8392 **MG**
 ☒ E27 / 1x max. 60W
 IP43 • 19052
 antique gold/transparent



5 362250 283227

8393 **MG**
 ☒ E27 / 1x max. 60W
 IP43 • 19052
 antique gold/transparent



5 362250 283224

8394 **MG**
 ☒ E27 / 1x max. 60W
 IP43 • 19052
 antique gold/transparent



5 362250 283261

8395 **MG**
 ☒ E27 / 1x max. 60W
 IP43 • 19052
 antique gold/transparent



5 362250 283278



8370

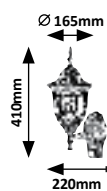

8376

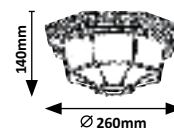

8371

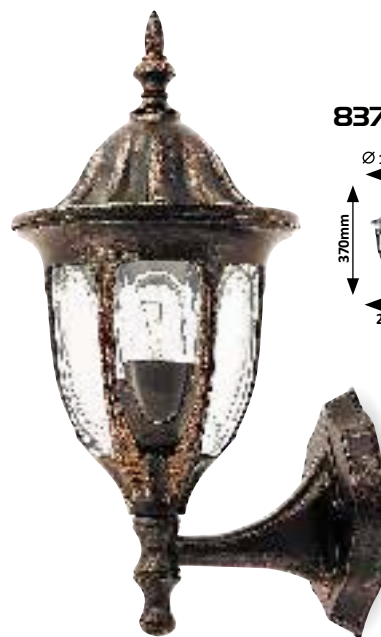
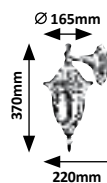

8372

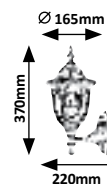

8370 (M) (G)

☒ E27 / 1x max. 60W
IP43 • 9449
8m, 120°
antique gold/transparent



5 362250 323700

8371 (M) (G)

☒ E27 / 1x max. 60W
IP43 • 9449
antique gold/transparent



5 362250 323712

8372 (M) (G)

☒ E27 / 1x max. 60W
IP43 • 9449
antique gold/transparent



5 362250 323720

8376 (M) (G)

☒ E27 / 1x max. 100W
IP43 • 9446
antique gold/opal glass



5 362250 323767

MILANO



8373

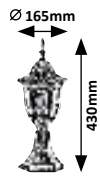

8374

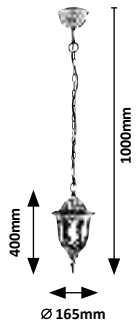

8375

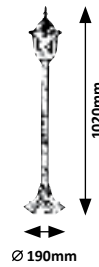

8373 **MG**

☒ E27 / 1x max. 60W
IP43 • 9449
antique gold/transparent



8374 **MG**

☒ E27 / 1x max. 60W
IP43 • 9449
antique gold/transparent



8375 **MG**

☒ E27 / 1x max. 60W
IP43 • 9449
antique gold/transparent





MILANO



7837

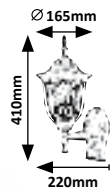

8341

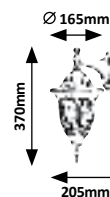

8342

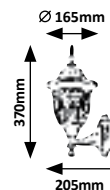

7837 (M) (G)

☒ E27 / 1x max. 60W
IP43 • 9449
☒ 8m, 120°
matte black/transparent



S 362250 7837-8

8341 (M) (G)

☒ E27 / 1x max. 60W
IP43 • 9449
matte black/transparent



S 362250 8341-8

8342 (M) (G)

☒ E27 / 1x max. 60W
IP43 • 9449
matte black/transparent



S 362250 8342-8



8346

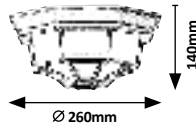

8343

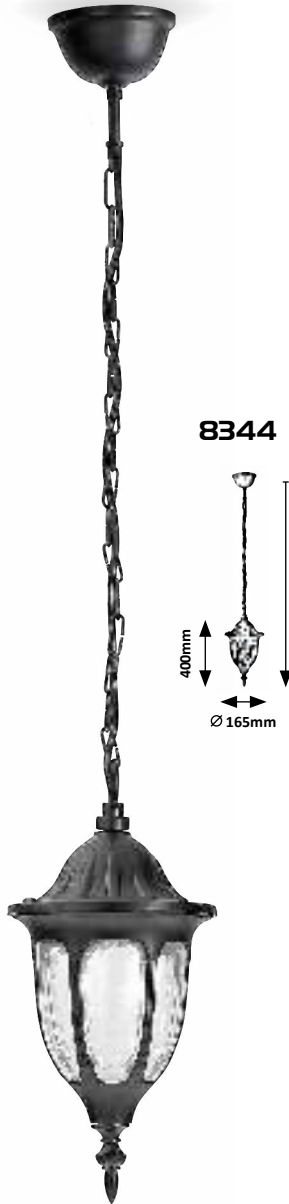
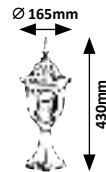

8344

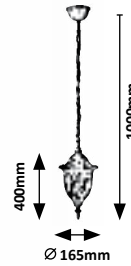

8345

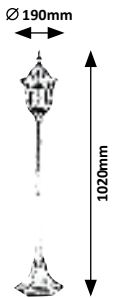

8343 (M) (G)

☒ E27 / 1x max. 60W
IP43 • 9449
matte black/transparent



5 398250 323430

8344 (M) (G)

☒ E27 / 1x max. 60W
IP43 • 9449
matte black/transparent



5 398250 323440

8345 (M) (G)

☒ E27 / 1x max. 60W
IP43 • 9449
matte black/transparent



5 398250 323450

8346 (M) (G)

☒ E27 / 1x max. 100W
IP43 • 9446
matte black/transparent



5 398250 323460

VELENCE

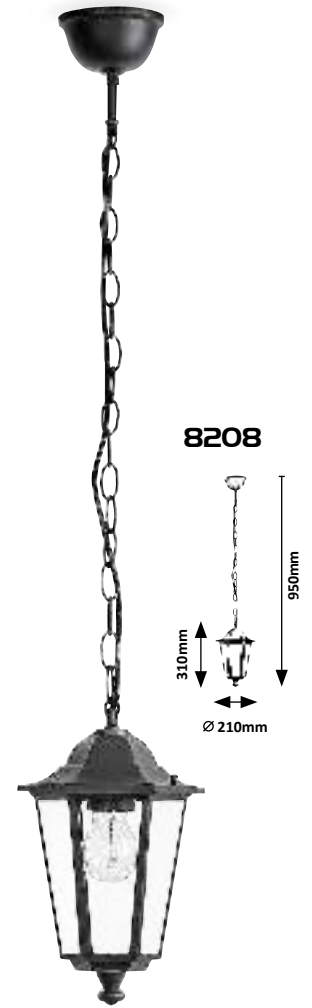

8202 (M) (G)

☒ E27 / 1x max. 60W
 IP43 • 9283
 black/transparent



8204 (M) (G)

☒ E27 / 1x max. 60W
 IP43 • 9283
 black/transparent



8206 (M) (G)

☒ E27 / 1x max. 60W
 IP43 • 9283
 black/transparent



8208 (M) (G)

☒ E27 / 1x max. 60W
 IP43 • 9283
 black/transparent



8210 (M) (G)

☒ E27 / 1x max. 60W
 IP43 • 9283
 black/transparent



8217 (M) (G)

☒ E27 / 1x max. 60W
 IP43 • 9283
 8m, 120°
 black/transparent



VELENCE



8201



8203

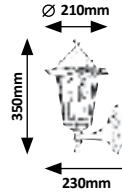

8205

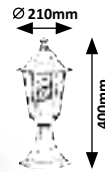

8216

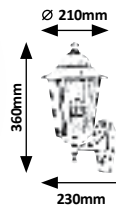

8209

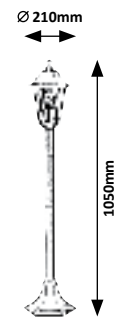

8207

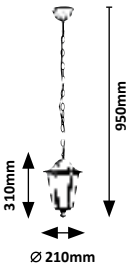

8201 **M G**

☒ E27 / 1x max. 60W
IP43 • 9283
white/transparent



8203 **M G**

☒ E27 / 1x max. 60W
IP43 • 9283
white/transparent



8205 **M G**

☒ E27 / 1x max. 60W
IP43 • 9283
white/transparent



8207 **M G**

☒ E27 / 1x max. 60W
IP43 • 9283
white/transparent



8209 **M G**

☒ E27 / 1x max. 60W
IP43 • 9283
white/transparent



8216 **M G**

☒ E27 / 1x max. 60W
IP43 • 9283
8m, 120°
white/transparent



VELENCE



8218

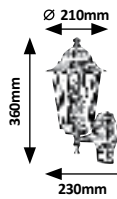

8234

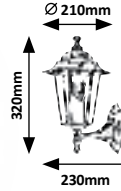

8236

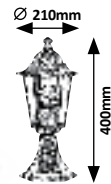

8232

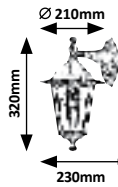

8240

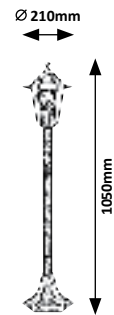

8238

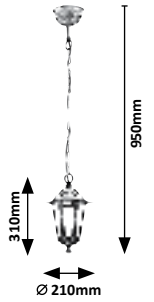

8218 **M G**

☒ E27 / 1x max. 60W
IP43 • 9283
8m, 120°
antique gold/transparent



5 362250 322180

8232 **M G**

☒ E27 / 1x max. 60W
IP43 • 9283
antique gold/transparent



5 362250 322320

8234 **M G**

☒ E27 / 1x max. 60W
IP43 • 9283
antique gold/transparent



5 362250 322340

8236 **M G**

☒ E27 / 1x max. 60W
IP43 • 9283
antique gold/transparent



5 362250 322360

8238 **M G**

☒ E27 / 1x max. 60W
IP43 • 9283
antique gold/transparent



5 362250 322380

8240 **M G**

☒ E27 / 1x max. 60W
IP43 • 9283
antique gold/transparent



5 362250 322400





8670



8696

MIAMI



8670

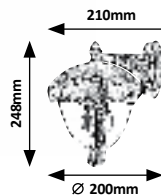

8671

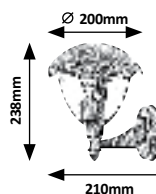

8676

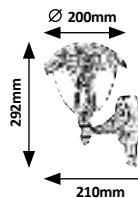

8674

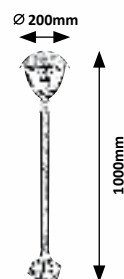

8670 (M) (P)

☒ E27 / 1x max. 40W
IP44
antique gold/transparent



8671 (M) (P)

☒ E27 / 1x max. 40W
IP44
antique gold/transparent



8674 (M) (P)

☒ E27 / 1x max. 40W
IP44
antique gold/transparent



8676 (M) (P)

☒ E27 / 1x max. 40W
IP44 • ☒ 0,5-12m, 140°
antique gold/transparent



NEW YORK



8696

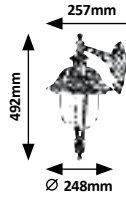

8699

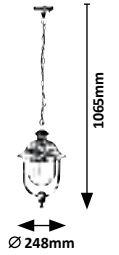

8697

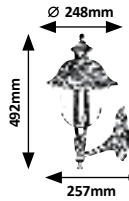

8700

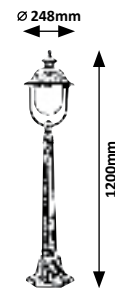

8698

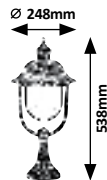

8696 (M) (P)

☒ E27 / 1x max. 100W
IP44 • 19448
antique gold/transparent



8697 (M) (P)

☒ E27 / 1x max. 100W
IP44 • 19448
antique gold/transparent



8698 (M) (P)

☒ E27 / 1x max. 100W
IP44 • 19448
antique gold/transparent



8699 (M) (P)

☒ E27 / 1x max. 100W
IP44 • 19448
antique gold/transparent



8700 (M) (P)

☒ E27 / 1x max. 100W
IP44 • 19448
antique gold/transparent





8163



8677

ODESSA



8163



8165

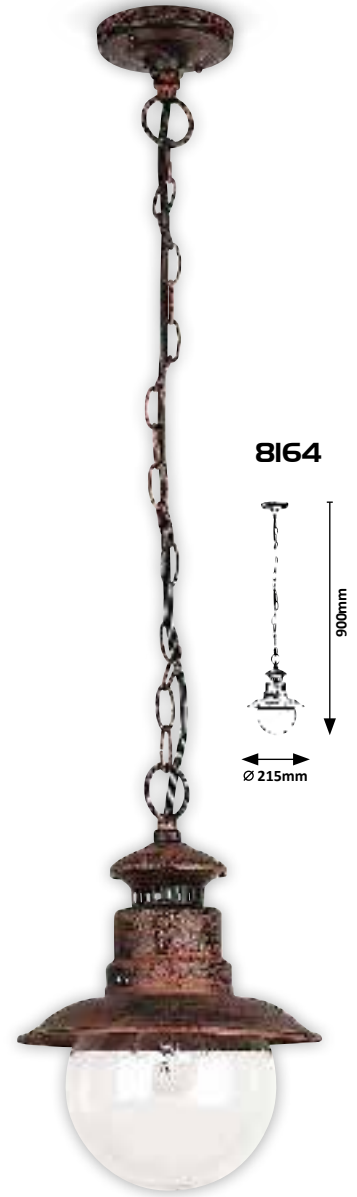

8164

8163 (M) (P)

☒ E27 / 1x max. 60W
IP44 • 19447
antique brown/transparent



5 368250 021673

8164 (M) (P)

☒ E27 / 1x max. 60W
IP44 • 19447
antique brown/transparent



5 368250 021640

8165 (M) (P)

☒ E27 / 1x max. 60W
IP44 • 19447
antique brown/transparent



5 368250 021677

BARCELONA

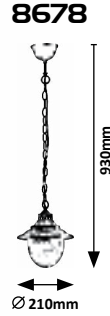
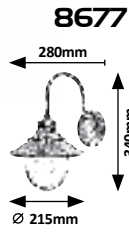

8677 **MG**

☒ E27 / 1x max. 60W
IP43 • 19375
antique gold/transparent



8678 **MG**

☒ E27 / 1x max. 60W
IP43 • 19375
antique gold/transparent



8679 **MG**

☒ E27 / 1x max. 60W
IP43 • 19375
antique gold/transparent



MADRID



8476

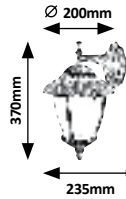

8377

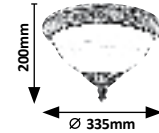

8477

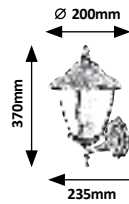

7836

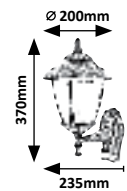

8478



7836 (M) (G)

☒ E27 / 1x max. 60W
IP43 • 9865
8m, 120°
antique gold/alabaster



S 36225C 323774

8377 (M) (G)

☒ E27 / 2x max. 40W
IP43 • 9866
antique gold/alabaster



S 36225C 323774

8476 (M) (G)

☒ E27 / 1x max. 60W
IP43 • 9865
antique gold/alabaster



S 36225C 323774

8477 (M) (G)

☒ E27 / 1x max. 60W
IP43 • 9865
antique gold/alabaster



S 36225C 324771

8478 (M) (G)

☒ E27 / 1x max. 60W
IP43 • 9865
antique gold/alabaster



S 36225C 324772

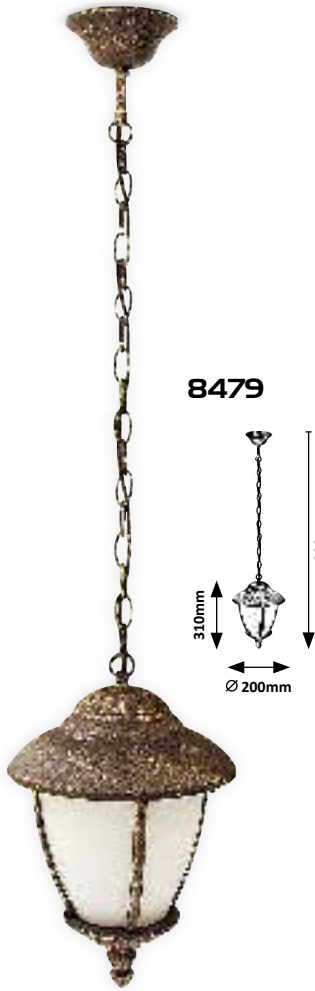

8479



8480



8379

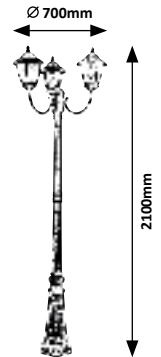

8379 (M) (G)

☒ E27 / 3x max. 60W
IP43 • 9865
antique gold/alabaster



5 362250 323796

8479 (M) (G)

☒ E27 / 1x max. 60W
IP43 • 9865
antique gold/alabaster



5 362250 323795

8480 (M) (G)

☒ E27 / 1x max. 60W
IP43 • 9865
antique gold/alabaster



5 362250 324801



MARSEILLE



8617

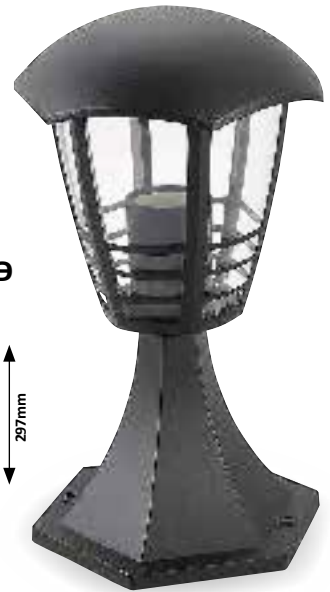
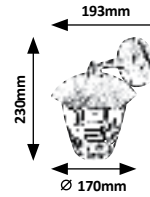

8619

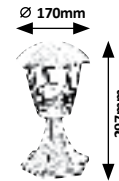

8618

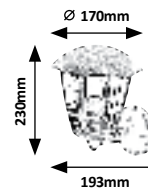

8617 (M) (P)

☒ E27 / 1x max. 60W
IP44
black/transparent



8618 (M) (P)

☒ E27 / 1x max. 60W
IP44
black/transparent



8619 (M) (P)

☒ E27 / 1x max. 60W
IP44
black/transparent



MARSEILLE

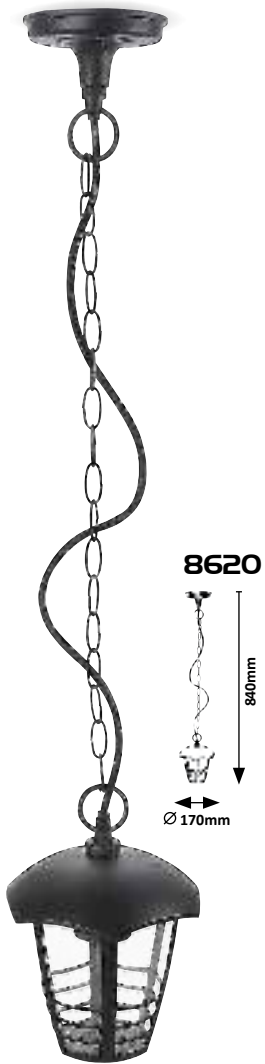

8620

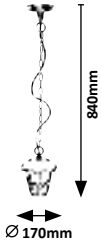

8568

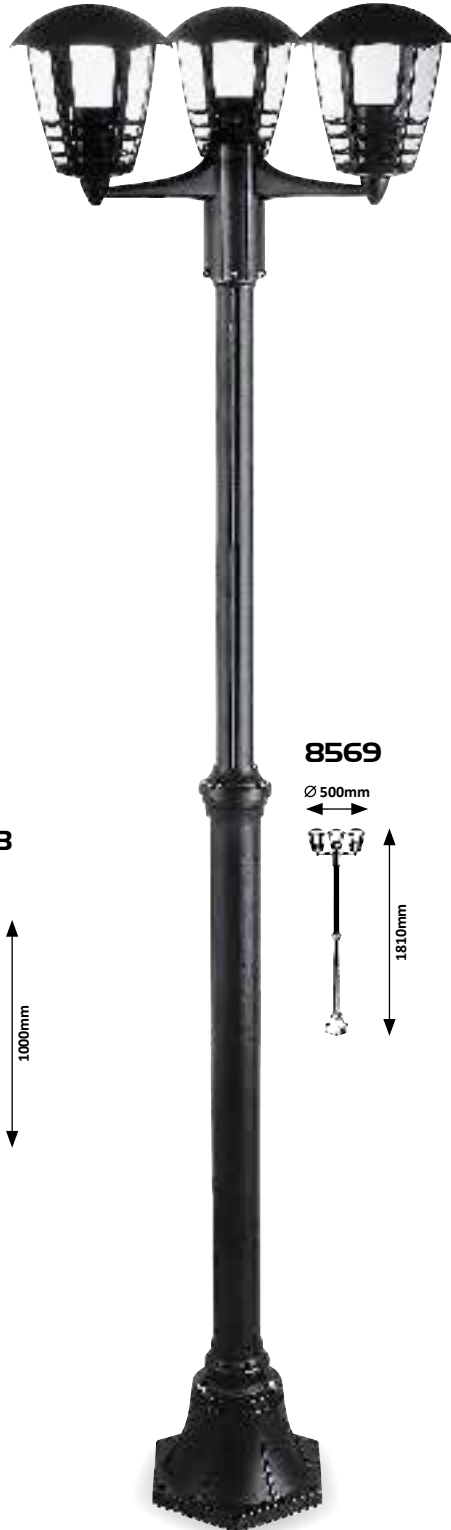

8569

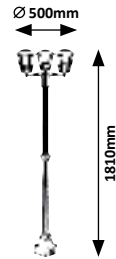

8570



8578

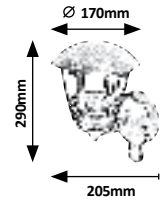

8620 (M) (P)

☒ E27 / 1x max. 60W
IP44
black/transparent



5 362250 325201

8568 (M) (P)

☒ E27 / 1x max. 60W
IP44
black/transparent



5 362250 325206

8569 (M) (P)

☒ E27 / 3x max. 60W
IP44
black/transparent



5 362250 325203

8570 (M) (P)

☒ E27 / 1x max. 60W
IP44
black/transparent



5 362250 325700

8578 (M) (P)

☒ E27 / 1x max. 60W
IP44
☒ 0,5-12m, 140°
black/transparent



5 362250 325785



KONSTANZ

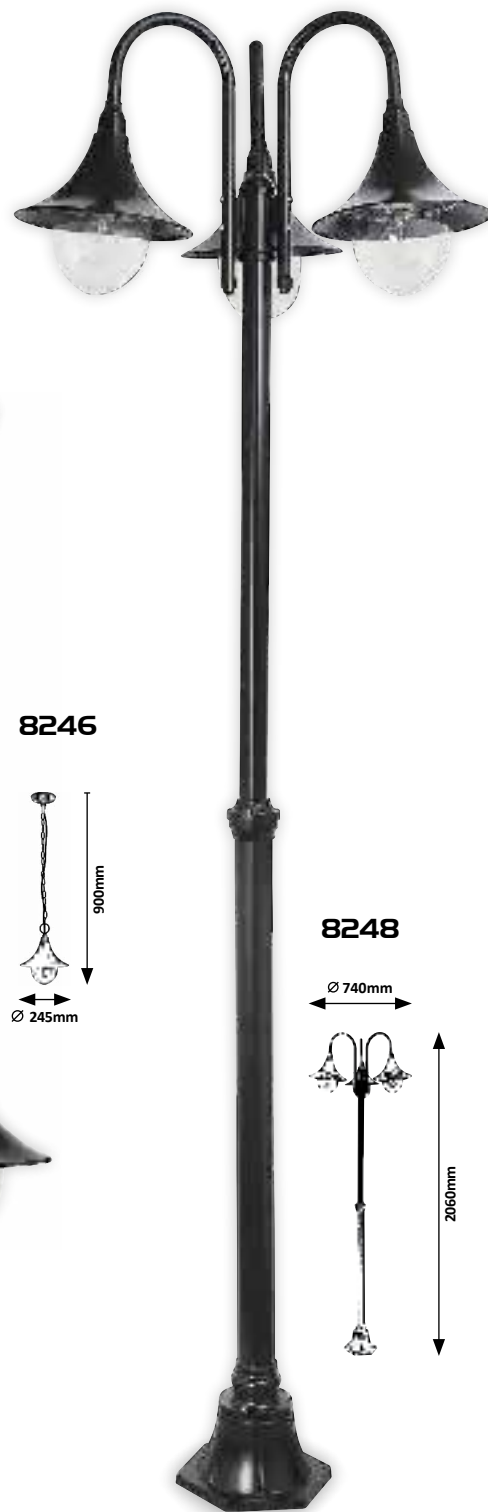
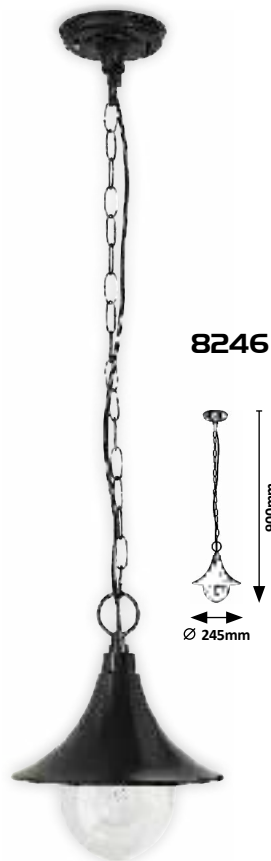

8245 (M) (P)

☒ E27 / 1x max. 100W
IP44 • 19609
black/transparent



5 362254 322476

8246 (M) (P)

☒ E27 / 1x max. 100W
IP44 • 19609
black/transparent



5 362254 322473

8247 (M) (P)

☒ E27 / 1x max. 100W
IP44 • 19609
black/transparent



5 362254 322470

8248 (M) (P)

☒ E27 / 3x max. 100W
IP44 • 19609
black/transparent



5 362254 322487

VIGO

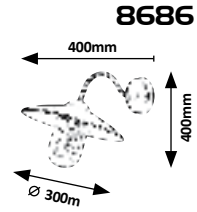

8686

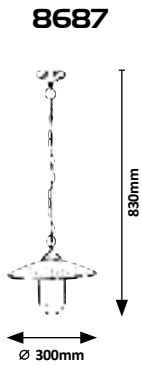
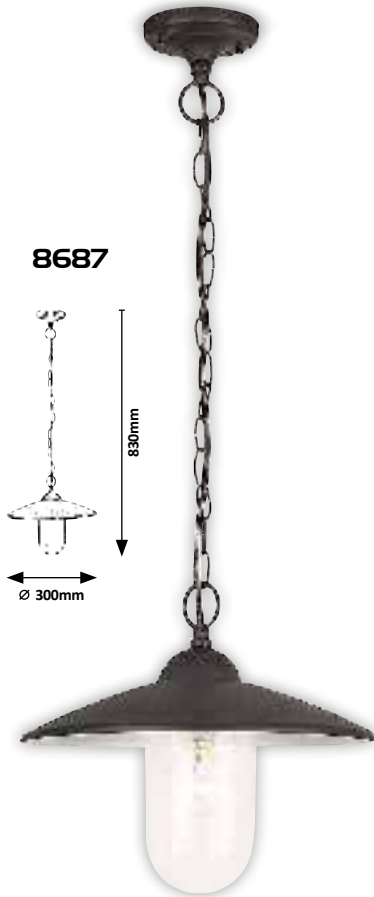

8687

PAVIA

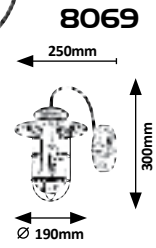

8069



8070

8686 (M) (G)

☒ E27 / 1x max. 60W
IP44 • 19446
matte black/white/
transparent



5 392250 320807

8687 (M) (G)

☒ E27 / 1x max. 60W
IP44 • 19446
matte black/white/
transparent



5 392250 320804

8069 (M) (G)

☒ E27 / 1x max. 60W
IP44 • 19527
matte black/transparent



5 392250 320598

8070 (M) (G)

☒ E27 / 1x max. 60W
IP44 • 19527
matte black/transparent



5 392250 320704



8270



8271



8681

OSLO



8270

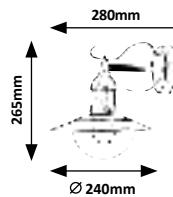

8763

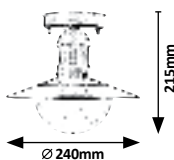

8764

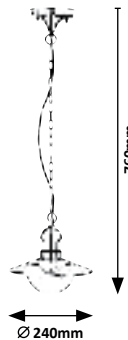

8270 (M) (P)

☒ E27 / 1x max. 60W
IP44 • 19050
satin chrome/transparent



8763 (M) (P)

☒ E27 / 1x max. 60W
IP44 • 19050
satin chrome/transparent



8764 (M) (P)

☒ E27 / 1x max. 60W
IP44 • 19050
satin chrome/transparent



OSLO



8737

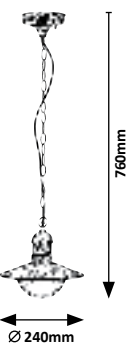

8271

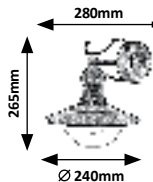

8736

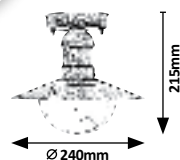

8739

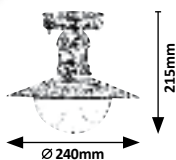

8681

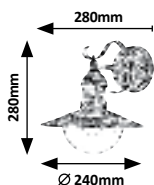

8740



8271

(M P)

☒ E27 / 1x max. 60W
IP44 • 19050
antique gold/transparent



8681

(M P)

☒ E27 / 1x max. 60W
IP44 • 19050
antique white/transparent



8736

(M P)

☒ E27 / 1x max. 60W
IP44 • 19050
antique gold/transparent



8737

(M P)

☒ E27 / 1x max. 60W
IP44 • 19050
antique gold/transparent



8739

(M P)

☒ E27 / 1x max. 60W
IP44 • 19050
antique white/transparent



8740

(M P)

☒ E27 / 1x max. 60W
IP44 • 19050
antique white/transparent





8680

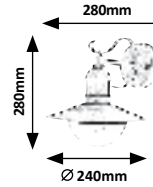

8682

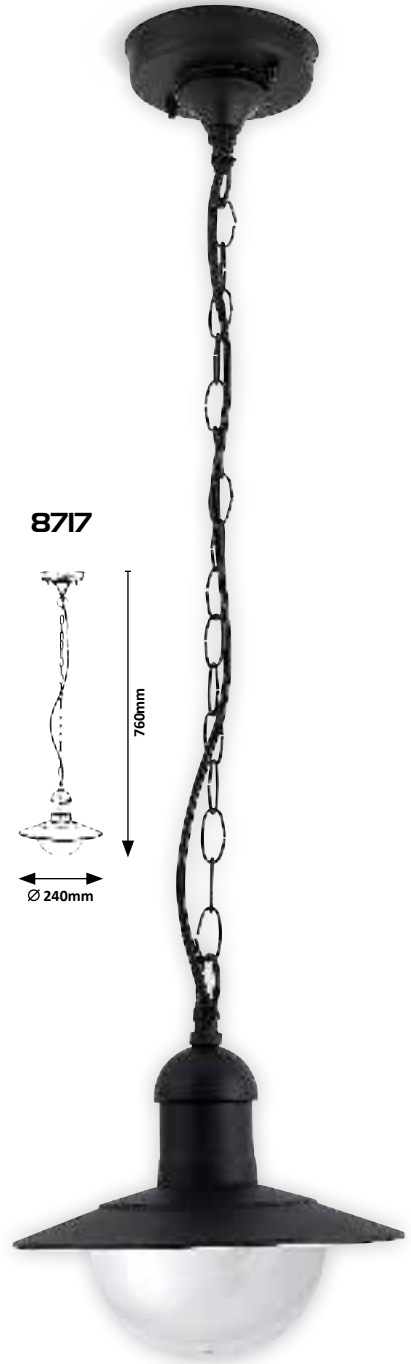
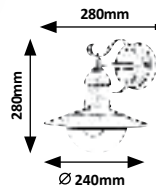

8717

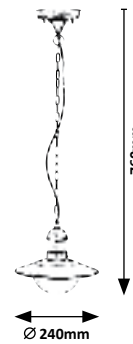

8716

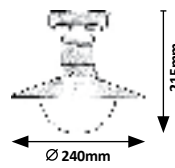

8680 (M) (P)

☒ E27 / 1x max. 60W
IP44 • 19050
black/transparent



5 362250 326805

8682 (M) (P)

☒ E27 / 1x max. 60W
IP44 • 19050
green/transparent



5 362250 326820

8716 (M) (P)

☒ E27 / 1x max. 60W
IP44 • 19050
black/transparent



5 362250 327161

8717 (M) (P)

☒ E27 / 1x max. 60W
IP44 • 19050
black/transparent



5 362250 327172

SYDNEY

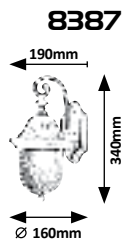

8388



HAGA

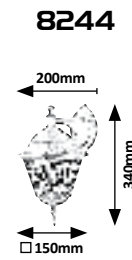
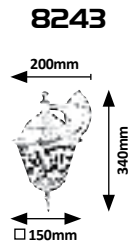

8244



8243 (M) (G)

☒ E27 / 1x max. 100W
IP44 • 19187
black/transparent



8244 (M) (G)

☒ E27 / 1x max. 100W
IP44 • 19187
antique gold/transparent



8387 (M) (G)

☒ E27 / 1x max. 60W
IP23 • 9802
black/transparent



8388 (M) (G)

☒ E27 / 1x max. 60W
IP23 • 9802
antique gold/transparent





DARIUS



8190

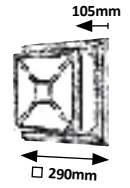

HEKTOR



8496

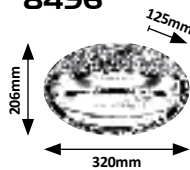

8499

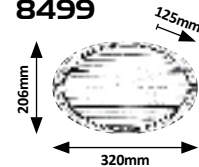

8190 (M) (P)

☒ E27 / 2x max. 60W
IP54
antique gold/white



5 398296 321300

8496 (M) (G)

☒ E27 / 1x max. 100W
IP54 • 9282
antique gold/white



5 398296 324302

8499 (M) (G)

☒ E27 / 1x max. 100W
IP54 • 9282
antique gold/white



5 398296 324303

DURANGO



8766

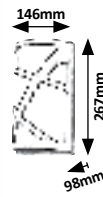

8767

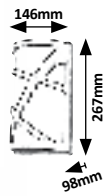

8766 (M) (P)

☒ E27 / 1x max. 40W
IP54
brown/white



5 362250 327673

8767 (M) (P)

☒ E27 / 1x max. 40W
IP54
anthracite/white



5 362250 327673



INNSBRUCK

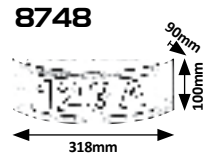

MANHATTAN

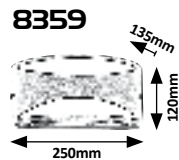
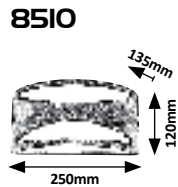

BIRMINGHAM

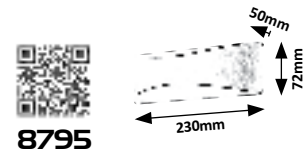

8748 (M) (P)

☒ E27 / 1x max. 14W
IP44
antique gold/white



8749 (M) (P)

☒ E27 / 1x max. 14W
IP44
satin chrome/white



8359 (M) (P)

☒ E27 / 1x max. 60W
IP54
matte black/white



8510 (M) (P)

☒ E27 / 1x max. 60W
IP54
antique gold/white



8795 (M) (P)

☒ LED / 7W
(796lm, 4000K) incl.
IP65
anthracite/white



ROMA



8409

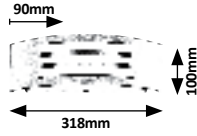

8511

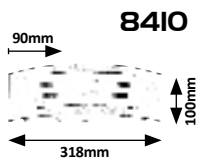
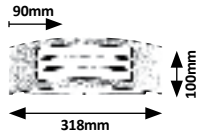

8410

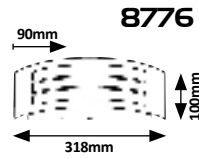

8776

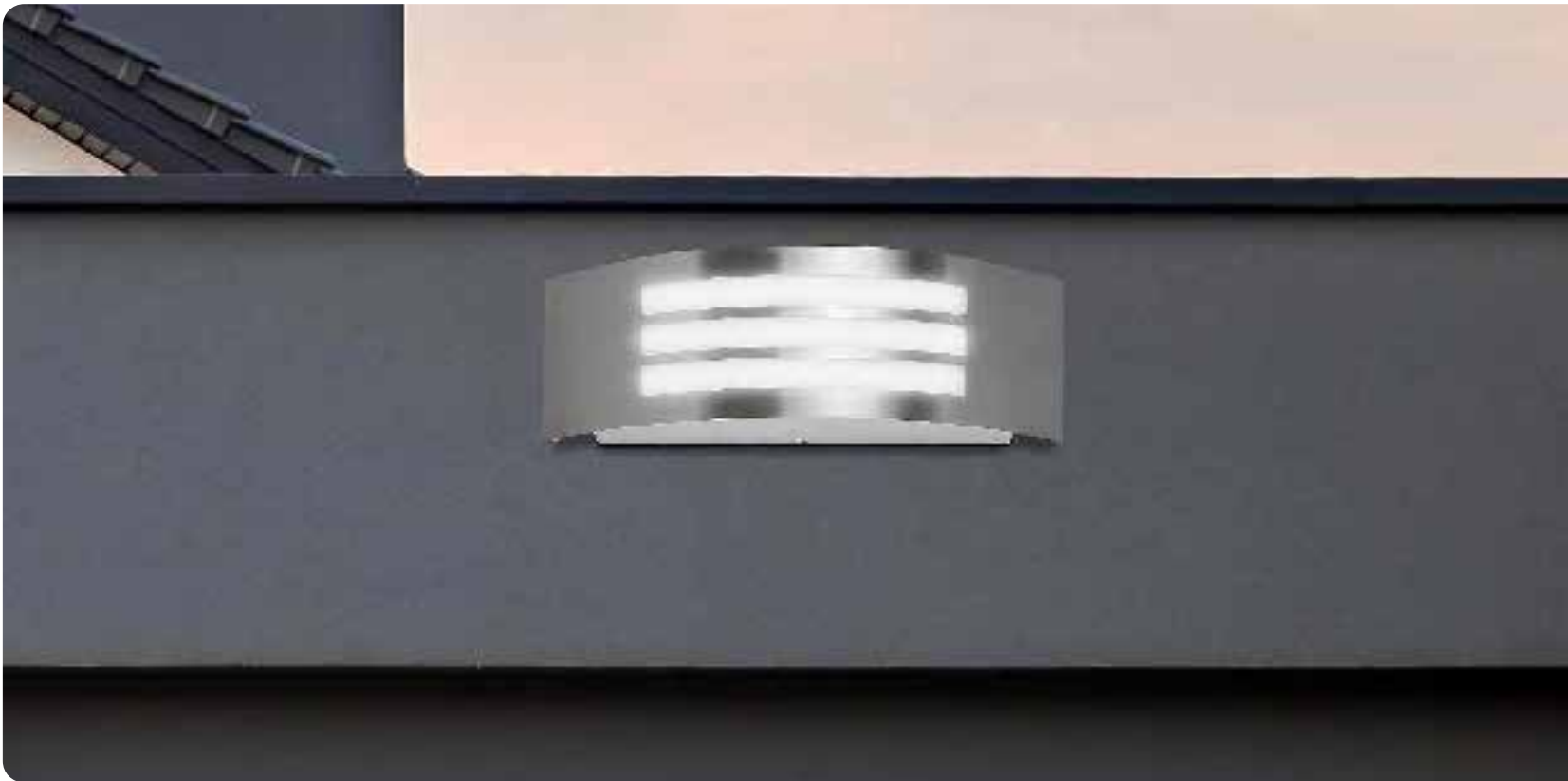
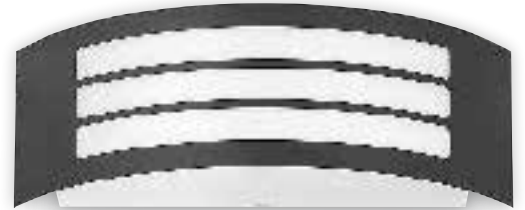

8409 (M) (P)

☒ E27 / 1x max. 14W
IP44
matte black/white



S 392250 024092

8410 (M) (P)

☒ E27 / 1x max. 14W
IP44
satin chrome/white



S 392250 024102

8511 (M) (P)

☒ E27 / 1x max. 14W
IP44
antique gold/white



S 392250 025112

8776 (M) (P)

☒ E27 / 1x max. 14W
IP44
anthracite/white



S 392250 027703

TOPEKA



8140

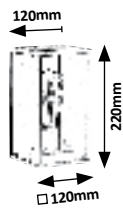

ZATON



7070

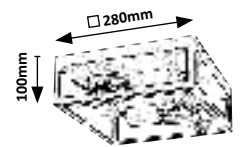

ORLOVA



7244

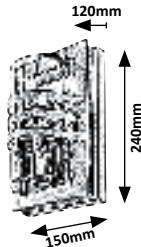

NOVIGRAD



7236

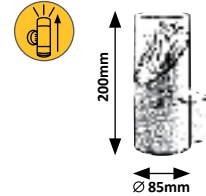

7237

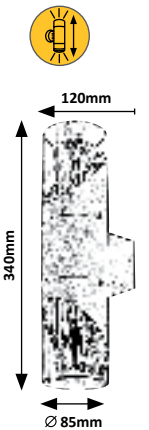

8140 (M)G

☒ E27 / 1x max. 60W
IP54 • 19515
transparent/black



7070 (M)G

☒ E27 / 2x max. 60W
IP23 • 19246
matte black/transparent



7244 (M)P

☒ E27 / 1x max. 40W
IP44 • 19177
black/transparent



7236 (M)P

☒ E27 / 1x max. 28W
IP54 • 19168
black/transparent



7237 (M)P

☒ E27 / 2x max. 28W
IP54 • 19168
black/transparent



TEPLICE



New

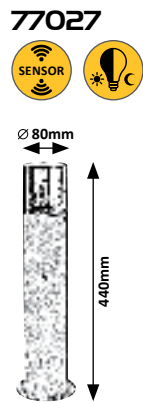
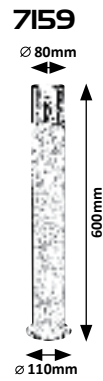
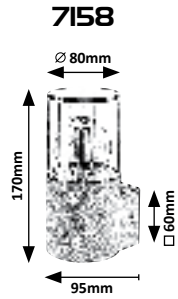

7158 (M) (P)
 ☒ E27 / 1x max. 12W
 IP44 • 19156
 matte black/tinted colour



7159 (M) (P)
 ☒ E27 / 1x max. 12W
 IP44 • 19156
 matte black/tinted colour



77027 (M) (P)
 ☒ E27 / 1x max. 12W
 IP44 • 19156
 ☑ 6-8 m, 105°
 matte black/tinted colour



WELLINGTON



7502

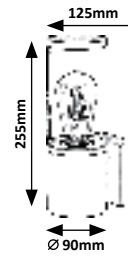

7503

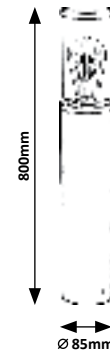

7502 (M) (P)

☒ E27 / 1x max. 60W
IP44 • 19978
matte black/transparent



5 408253 375021

7503 (M) (P)

☒ E27 / 1x max. 60W
IP44 • 19978
matte black/transparent



5 408253 375030

SILISTRA



7891

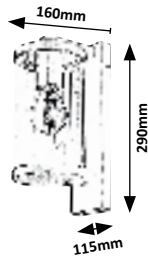

7892

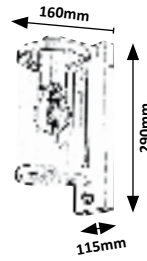

8753



NORVICH



8753

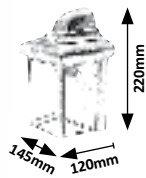

8754

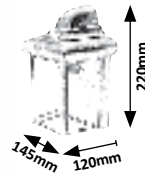

8754



7891 (M) (G)

☒ E27 / 1x max. 60W
IP44 • 19852
anthracite/transparent

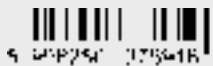

9 392290 327541R

7892 (M) (G)

☒ E27 / 1x max. 60W
IP44 • 19852
☕ 1-12m, 110°
anthracite/transparent

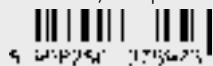

9 392290 327542R

8753 (M) (G)

☒ E27 / 1x max. 60W
IP43
19524 • 19523
antique white/transparent



9 392290 327530C

8754 (M) (G)

☒ E27 / 1x max. 60W
IP43
19524 • 19523
antique gold/transparent



9 392290 327543C

SEATTLE



8169

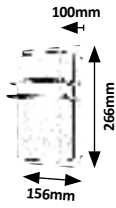

8229

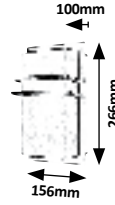

RODEZ



8940

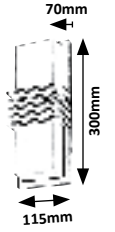

SEVILLA



8799

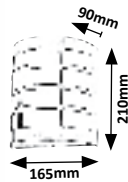

8800

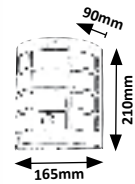

8169 (M P)

☒ E27 / 1x max. 11W
IP44
black/white



8229 (M P)

☒ E27 / 1x max. 11W
IP44
satin chrome/white



8940 (M P)

☒ LED / 12W
(800lm, 4000K) incl.
IP44
anthracite/white



8799 (M P)

☒ E27 / 1x max. 11W
IP44
satin chrome/white



8800 (M P)

☒ E27 / 1x max. 11W
IP44 • ☒ 0-5m, 100°
satin chrome/white



GENOVA



8269



7796



OPOLE



7797



ECUADOR



7996

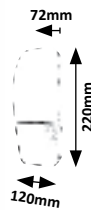

7997

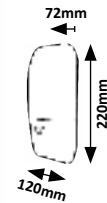

8269 M P G

☒ E27 / 1x max. 40W
IP44 • 19129
satin chrome/white



5 362250 322292

7796 P

☒ E27 / 1x max. 12W
IP65
matte black/white

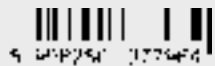

5 362250 377474

7797 P

☒ E27 / 1x max. 12W
IP65
matte black/white

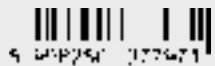

5 362250 377471

7996 M P

☒ LED / 9W
(800lm, 4000K) incl.
IP65
anthracite/white



5 362250 373506

7997 M P

☒ LED / 11W
(800lm, 4000K) incl.
IP54 • 6m, 120°
anthracite/white



5 362250 373073

7074



OFF



ON

CYPRUS



7074

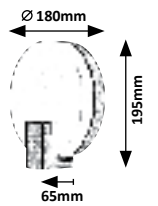

VARNA



8135

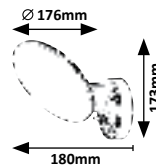

8134

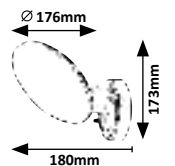

7074 (M) (P)

LED / 10W
(790lm, 1000lm; 3000K) incl.
IP44
black/white



5 908250 070741

8134 (P)

LED / 12W
(720lm, 4000K) incl.
IP54
black/white

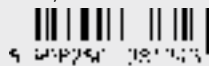

5 908250 081341

8135 (P)

LED / 12W
(720lm, 4000K) incl.
IP54 • 8m, 120°
black/white

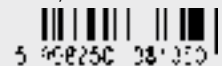

5 908250 081350

BONA

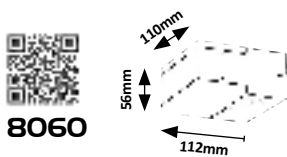

8060

GANGES

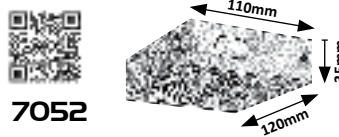
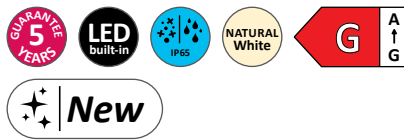

7052

RAPLA

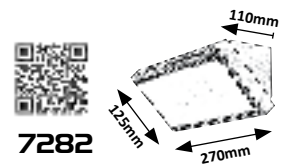

7282

HALDEN

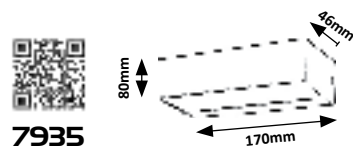

7935

TROGIR

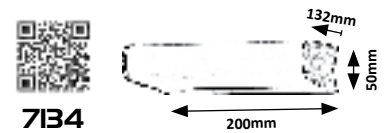

7134

8060 (M) (P)

LED / 9W
(678lm, 4000K) incl.
IP54
anthracite/white



5 352250 329205

7052 (M) (G)

LED / 7W
(575lm, 720lm; 4000K) incl.
IP65
matte black/transparent



5 038253 370521

7282 (P)

LED / 12W
(1000lm, 1820lm; 4000K) incl.
IP54
black/white



5 038253 372822

7935 (P)

LED / 9W
(640lm, 4000K) incl.
IP65
black/white



5 038253 379357

7134 (M) (P)

LED / 6,5W
(590lm, 4000K) incl.
IP44
anthracite/white



5 038253 371344



PALANGA



7504

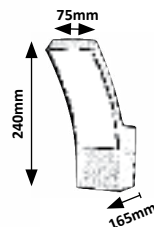

7505

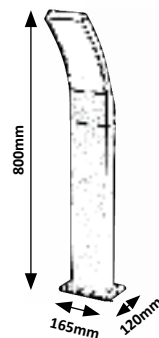
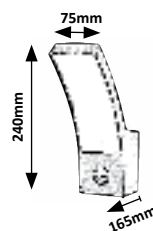

7506

7504 (M) (P)

LED / 12W
(800lm, 3000K) incl.
IP44
anthracite/white



7505 (M) (P)

LED / 12W
(800lm, 3000K) incl.
IP44 • 7m, 106°
anthracite/white



7506 (M) (P)

LED / 12W
(800lm, 3000K) incl.
IP44
anthracite/white



HONG KONG

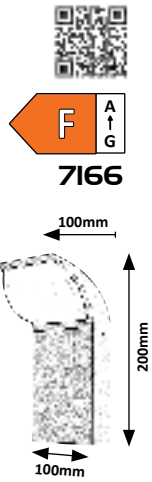

7166



7167

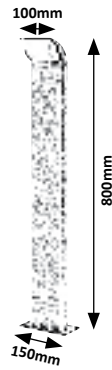

LIMA



7925

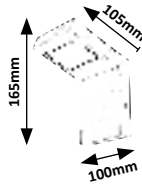

7166

(M) (P)

LED / 9W
 (660lm, 1100lm; 4000K) incl.
 IP65
 black/white



7167

(M) (P)

LED / 9W
 (580lm, 1100lm; 4000K) incl.
 IP65
 black/white



7925

(P)

LED / 9W
 (600lm, 3000K) incl.
 IP44
 matte black/white



7904

INDIRECT



BELFAST



7904

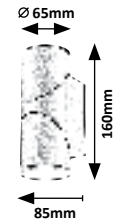

ELVA



7930

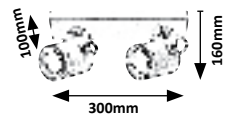

7929

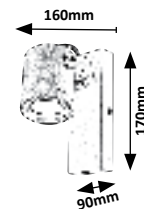

7904 (M) (P)

LED / 12,9W
(620lm, 3000K) incl.
IP65
anthracite/white



5 362250 173243

7929 (M) (G)

GU10 / 1x max. 35W
IP44
anthracite/transparent



5 362250 173290

7930 (M) (G)

GU10 / 2x max. 35W
IP44
anthracite/transparent



5 362250 173302

ZOMBOR



AKRON

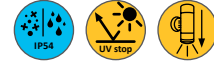

7817

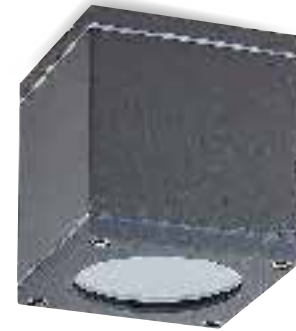
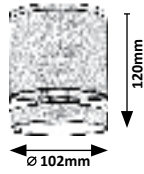

8149

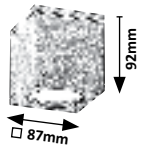

7818

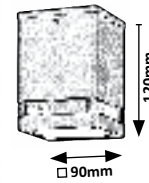

7819

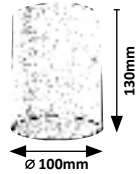

8150

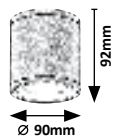

7820

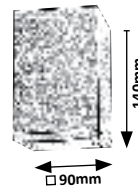

7817

(M P)

☒ GU10 / 1x max. 35W
IP54
anthracite/transparent



7818

(M P)

☒ GU10 / 1x max. 35W
IP54
anthracite/transparent



7819

(M G)

☒ GU10 / 1x max. 35W
IP54
anthracite/opal glass



7820

(M G)

☒ GU10 / 1x max. 35W
IP54
anthracite/opal glass



8149

(M G)

☒ GU10 / 1x max. 35W
IP54
anthracite



8150

(M G)

☒ GU10 / 1x max. 35W
IP54
anthracite



BALTIMORE



8730

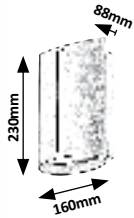

8731

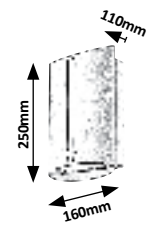

8730 (M) (P)

☒ E27 / 1x max. 25W
IP54
matte black



5 362250 327307

8731 (M) (P)

☒ E27 / 1x max. 25W
IP44
☒ 2-8 m, 90°
matte black



5 362250 327314

NESNA

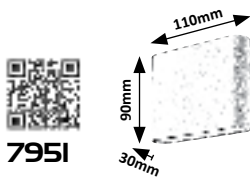

7951

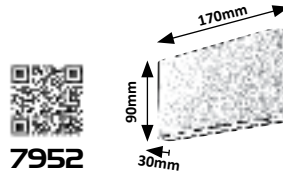

7952

8873

INDIRECT



MARIBOR

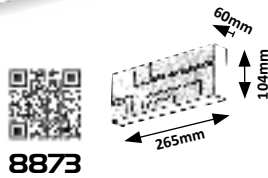
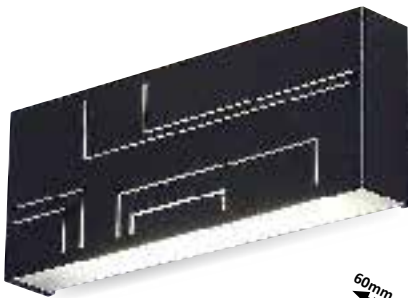
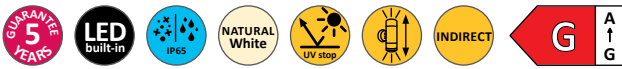

8873

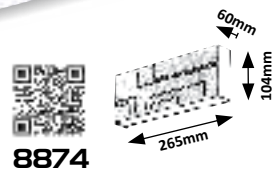

8874

8874



7951 (M G)

LED / 6W
(386lm, 3000K) incl.
IP54 • 19626
anthracite/opal glass



5 392290 373577

7952 (M G)

LED / 12W
(528lm, 3000K) incl.
IP54 • 19630
anthracite/opal glass



5 392290 373524

8873 (M P)

LED / 12W
(780lm, 4000K) incl.
IP65
black



5 392290 325771

8874 (M P)

LED / 12W
(780lm, 4000K) incl.
IP65
white

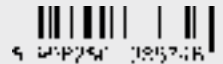

5 392290 325716



NAVIA

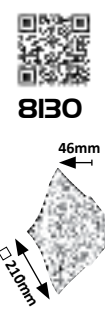
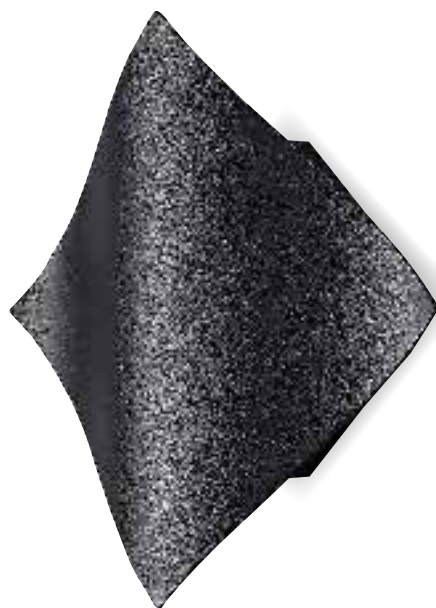

FOLLINA

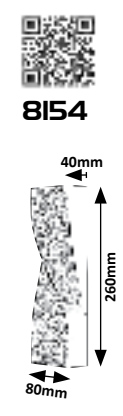

8130



LED / 11W
(641lm, 4000K) incl.
IP65
black



5 938750 72135

8154



LED / 11W
(530lm, 4000K) incl.
IP65
black



5 938750 08154

LIPPA

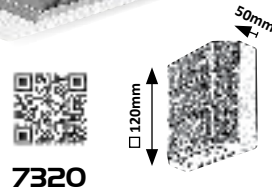
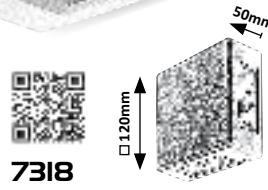
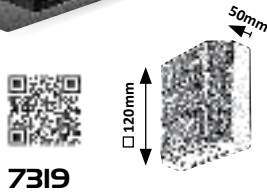
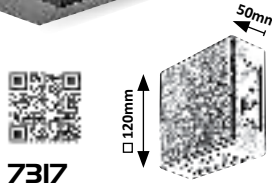

7317, 7318



7319, 7320



7317 (P)

LED / 6W
(190lm, 3000K) incl.
IP54
black



7318 (P)

LED / 6W
(360lm, 3000K) incl.
IP54
white



7319 (P)

LED / 6W
(70lm, 3000K) incl.
IP54
black



7320 (P)

LED / 6W
(150lm, 3000K) incl.
IP54
white



7246, 7247



DURBE



7246

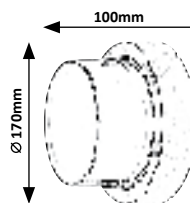

7247

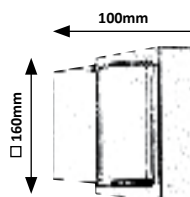

7246



LED / 10W
(780lm, 1200lm; 3000K-6500K) incl.
IP54
black/white



5 038253 072464

7247



LED / 10W
(790lm, 1200lm; 3000K-6500K) incl.
IP54
black/white



5 038253 072471

INVERNESS

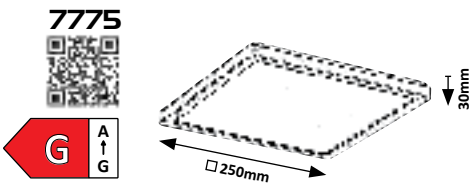
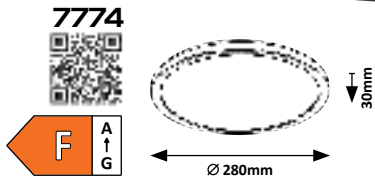

7774, 7775



7774 (P)
 LED / 15W
 (1300lm, 2700K-6500K) incl.
 IP44 • 555
 black/white



7775 (P)
 LED / 15W
 (1190lm, 2700K-6500K) incl.
 IP44 • 555
 black/white



TARTU

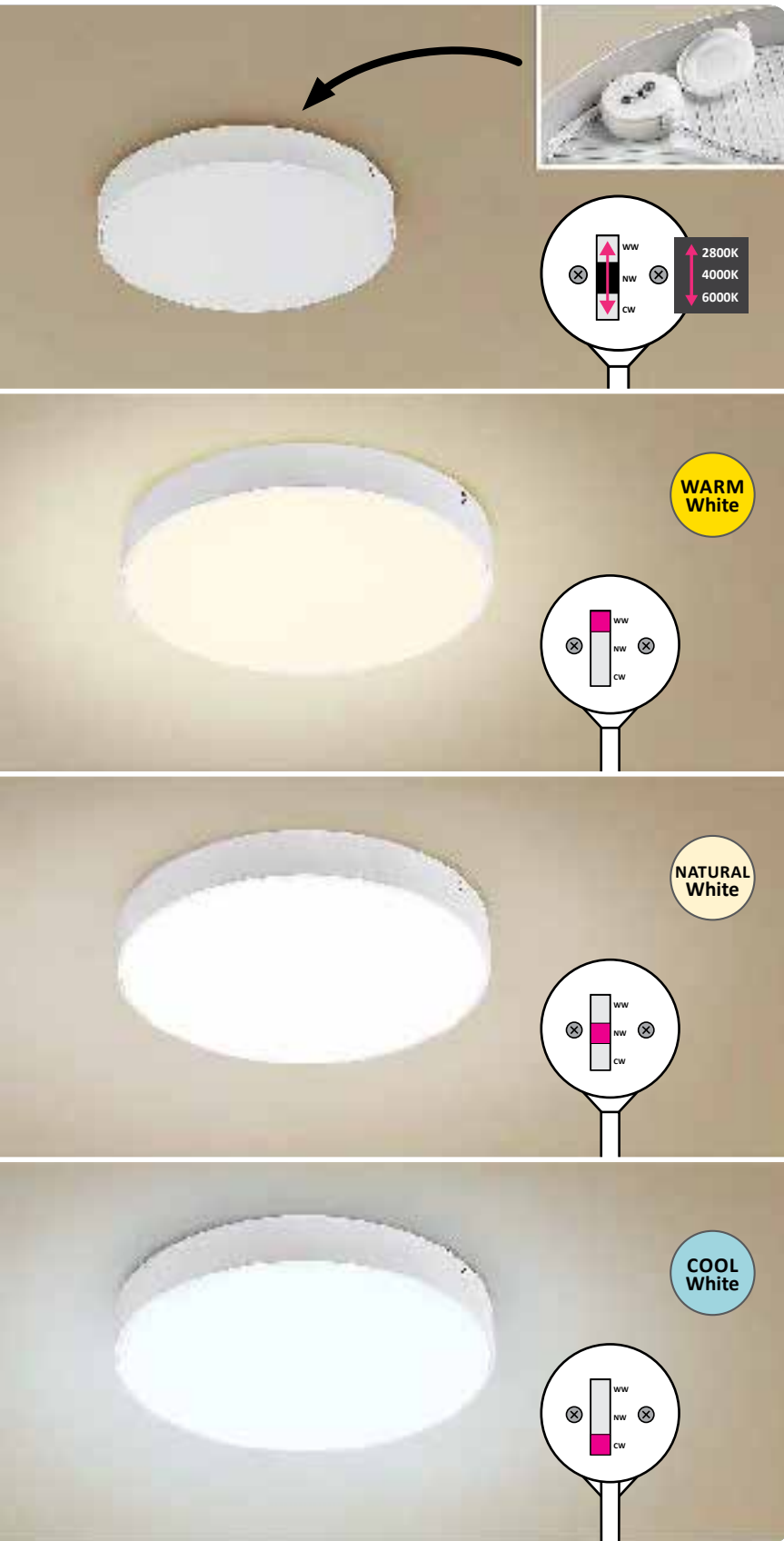

7893

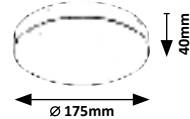

7894

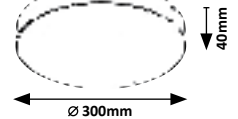

7895

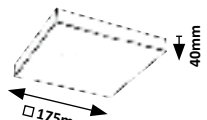

7896

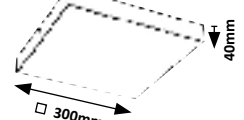

7893 (M) (P)

LED / 18W
(1800lm, 2800K-6000K) incl.
IP44
matte white/white



S 36225C 175270

7894 (M) (P)

LED / 24W
(2500lm, 2800K-6000K) incl.
IP44
matte white/white



S 36225C 175267

7895 (M) (P)

LED / 18W
(1800lm, 2800K-6000K) incl.
IP44
matte white/white



S 36225C 175274

7896 (M) (P)

LED / 24W
(2500lm, 2800K-6000K) incl.
IP44
matte white/white



S 36225C 175271

TARTU

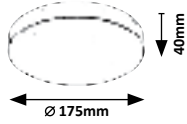

7897

Ø 175mm

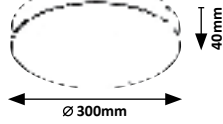

7898

Ø 300mm

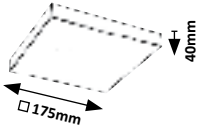
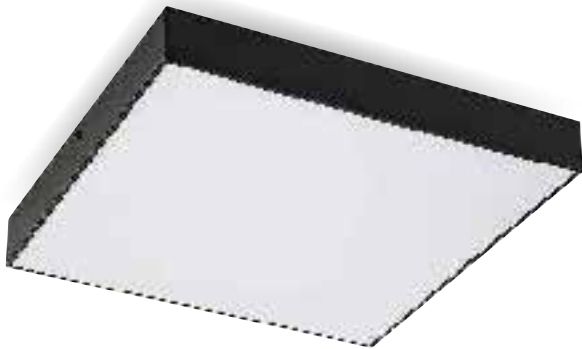

7899

□ 175mm

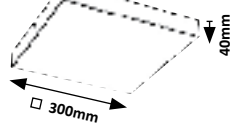

7900

□ 300mm



7897 (M) (P)

LED / 18W
(1800lm, 2800K, 4000K, 6000K) incl.
IP44
matte black/white



S 36225C 175327E

7898 (M) (P)

LED / 24W
(2500lm, 2800K, 4000K, 6000K) incl.
IP44
matte black/white



S 36225C 175328D

7899 (M) (P)

LED / 18W
(1800lm, 2800K, 4000K, 6000K) incl.
IP44
matte black/white



S 36225C 175329E

7900 (M) (P)

LED / 24W
(2500lm, 2800K, 4000K, 6000K) incl.
IP44
matte black/white



S 36225C 175330F

HAMBURG



8847

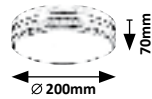

8848

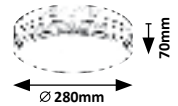

8849

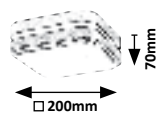

8850

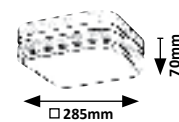

8847 (M) (P)

LED / 10W
(720lm, 4000K) incl.
IP44
anthracite/white



5 950750 308472

8848 (M) (P)

LED / 12W
(900lm, 4000K) incl.
IP44
anthracite/white



5 950750 308489

8849 (M) (P)

LED / 10W
(680lm, 4000K) incl.
IP44
anthracite/white



5 950750 308496

8850 (M) (P)

LED / 12W
(900lm, 4000K) incl.
IP44
anthracite/white

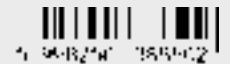

5 950750 308502

STUTTGART



8170

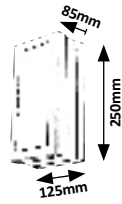

8220

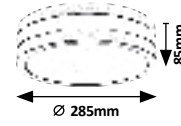

8227

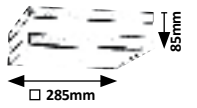

8683

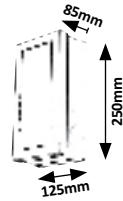

8684

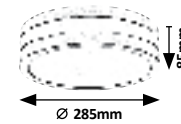

8685

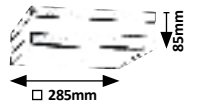

8170 (M) (P)

☒ E27 / 1x max. 14W
IP44
satin chrome/white



8220 (M) (P)

☒ E27 / 2x max. 11W
IP44
satin chrome/white



8227 (M) (P)

☒ E27 / 2x max. 11W
IP44
satin chrome/white



8683 (M) (P)

☒ E27 / 1x max. 14W
IP44
anthracite/white



8684 (M) (P)

☒ E27 / 2x max. 11W
IP44
anthracite/white



8685 (M) (P)

☒ E27 / 2x max. 11W
IP44
anthracite/white





BALIMO



7477

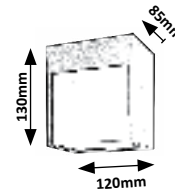

7476

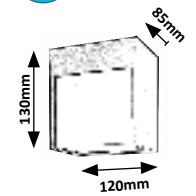

7478

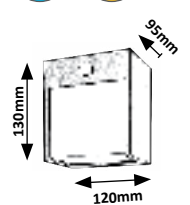

7479

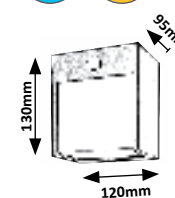

7476 (M P)

LED / 12W
(560lm, 4000K) incl.
IP54
matte black/white



7477 (M P)

LED / 12W
(560lm, 4000K) incl.
IP54
matte white/white



7478 (M P)

LED / 12W
(560lm, 4000K) incl.
IP44 • 7m, 106°
matte black/white



7479 (M P)

LED / 12W
(560lm, 4000K) incl.
IP44 • 7m, 106°
matte white/white



SOLIN



7396

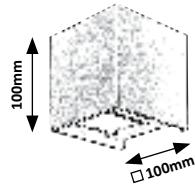

7397

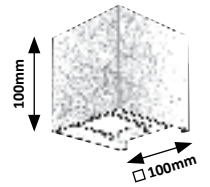

7396, 7397 Adjustable beam angle • Állítható világítási szög • Einstellbarer Abstrahlwinkel



7396 (M) (P)

☒ G9 / 1x max. 42W
IP54
matte black



5 908253 07361-1

7397 (M) (P)

☒ G9 / 1x max. 42W
IP54
matte white



5 908253 07367-1

AUSTIN



8797

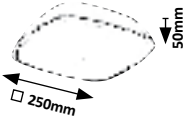

ALVORADA



8049

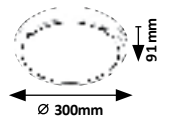

SALVADOR



8114

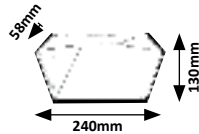

ONTARIO



7204

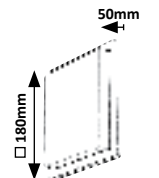

8797

(M) (P)

LED / 20W
(2000lm, 4000K) incl.
IP65
anthracite/white



5 398250 327370

8049

(P)

E27 / 2x max. 20W
IP65
anthracite/white



5 398250 325490

8114

(M) (P)

LED / 12W
(755lm, 4000K) incl.
IP65
black/white



5 398250 321115

7204

(M) (P)

LED / 8W
(730lm, 4000K) incl.
IP65
anthracite/white

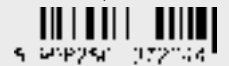

5 398250 327344

MENDOZA



7109

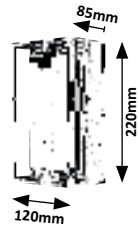

7110

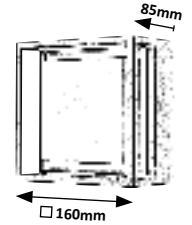

GORICA



7155

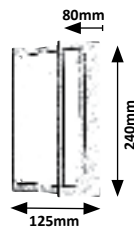

ANDORRA



8830

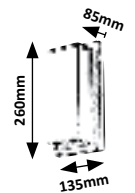

7109 (M) (P)

LED / 6,5W
(550lm, 3000K) incl.
IP65
anthracite/white

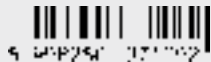

7110 (M) (P)

LED / 6,5W
(530lm, 3000K) incl.
IP65
anthracite/white

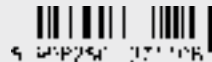

7155 (M) (P)

E27 / 1x max. 12W
IP44
matte black/white



8830 (M) (P)

LED / 12W
(680lm, 4000K) incl.
IP54
black/white

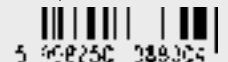



SINTRA



7955

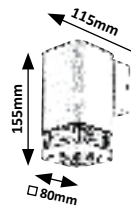

7956

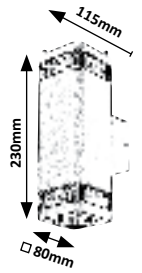

BUFFALO



7887

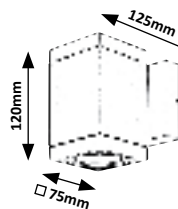

7888

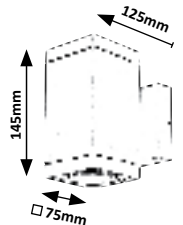

7955 (M P)

☒ GU10 / 1x max. 25W
IP44
matte black/transparent

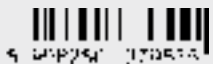

7956 (M P)

☒ GU10 / 2x max. 25W
IP44
matte black/transparent

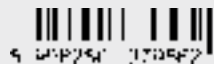

7887 (M G)

☒ GU10 / 1x max. 35W
IP54
anthracite/transparent



7888 (M G)

☒ GU10 / 2x max. 35W
IP54
anthracite/transparent

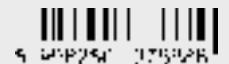

MANDAL



7960

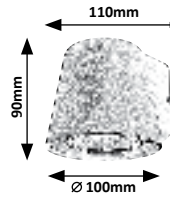

7959

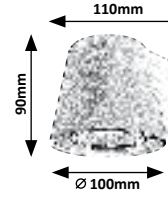

PHOENIX



8118

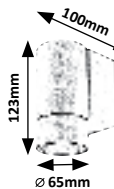

8119

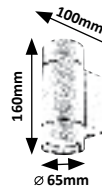

8118, 8119



7959 **MG**

☒ GU10 / 1x max. 35W
IP54
matte black/transparent



7960 **MG**

☒ GU10 / 1x max. 35W
IP54
matte white/transparent

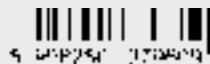

8118 **MG**

☒ GU10 / 1x max. 10W
IP54 • 19625
anthracite



8119 **MG**

☒ GU10 / 2x max. 10W
IP54 • 19625
anthracite



MEDINA

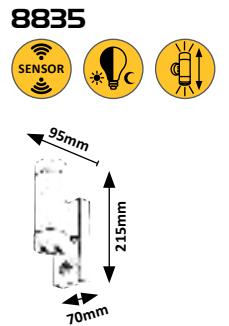
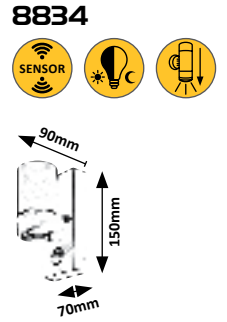
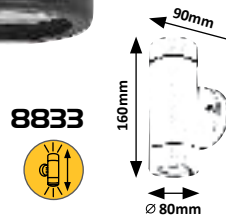
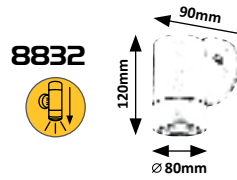
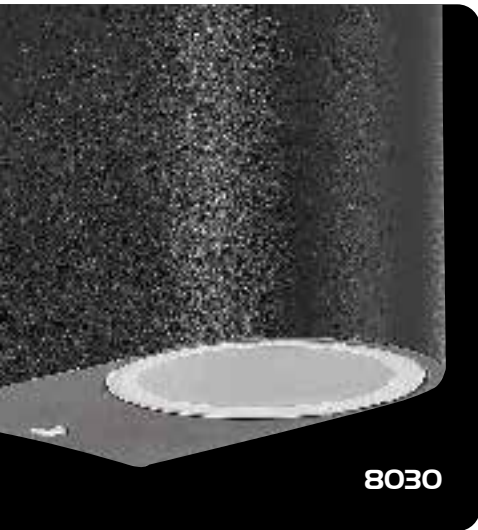

8832 **P**
 ☒ GU10 / 1x max. 10W
 IP44
 matte black/transparent



8833 **P**
 ☒ GU10 / 2x max. 10W
 IP44
 matte black/transparent



8834 **P**
 ☒ GU10 / 1x max. 10W
 IP44
 ☒ 2-8m, 90°
 matte black/transparent



8835 **P**
 ☒ GU10 / 2x max. 10W
 IP44
 ☒ 2-8m, 90°
 matte black/transparent



CHILE



8020

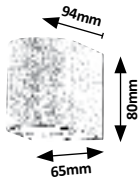

8029

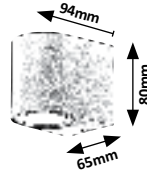

8018

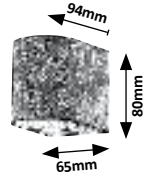

8034

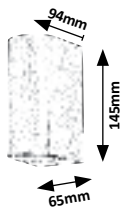

8030

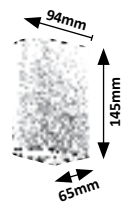

8019

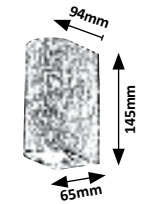

8020 **MG**

☒ GU10 / 1x max. 35W
IP44
brushed aluminium



8029 **MG**

☒ GU10 / 1x max. 35W
IP44
black



8030 **MG**

☒ GU10 / 2x max. 35W
IP44
black



8034 **MG**

☒ GU10 / 2x max. 35W
IP44
brushed aluminium



8018 **MG**

☒ GU10 / 1x max. 35W
IP44
antique brown



8019 **MG**

☒ GU10 / 2x max. 35W
IP44
antique brown



7379

ANKARA

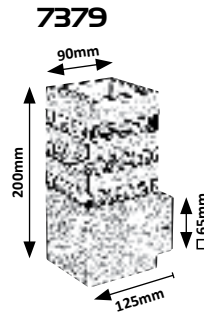

77025

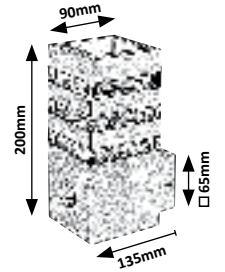

7380

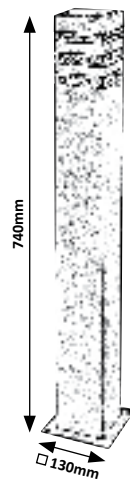

77026

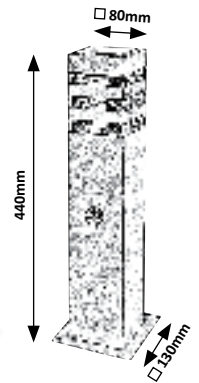

7379 (M) (P)

☒ E27 / 1x max. 12W
IP44
anthracite/transparent



7380 (M) (P)

☒ E27 / 1x max. 12W
IP44
anthracite/transparent



77025 (M) (P)

☒ E27 / 1x max. 12W
IP44 • 6-8m, 105°
anthracite/transparent



77026 (M) (G)

☒ E27 / 1x max. 12W
IP44 • 6-8m, 105°
anthracite/transparent



BONN



8337

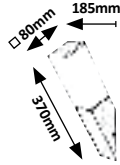

8338

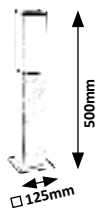

8339

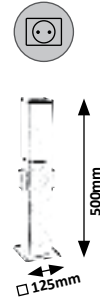

8337 (M) (P)

☒ E27 / 1x max. 60W
IP44 • 19130
matte black/white



8338 (M) (P)

☒ E27 / 1x max. 60W
IP44 • 19130
matte black/white



8339 (M) (P)

☒ E27 / 1x max. 60W
IP44 • 19130
matte black/white



KATOWICE



7914



7915



7916

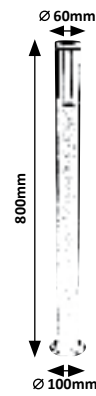

7914 (M) (P)

☒ GU10 / 1x max. 7W
IP44 • 19849
anthracite/transparent

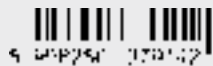

7915 (M) (P)

☒ GU10 / 1x max. 7W
IP44 • 19849
☒ 1-8m, 90°
anthracite/transparent

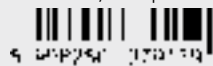

7916 (M) (P)

☒ GU10 / 1x max. 7W
IP44 • 19849
anthracite/transparent

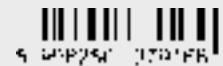

BLACK TORCH



8145

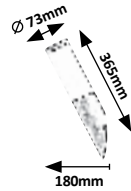

8146

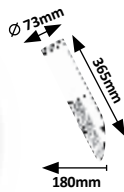

8147

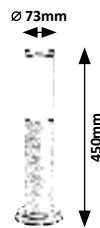

8148



8145 (M) (P)

☒ E27 / 1x max. 25W
IP44 • 19607
matte black/white



5 362250 021470

8146 (M) (P)

☒ E27 / 1x max. 25W
IP44 • 19607
☒ 0-5m, 100°
matte black/white



5 362250 021470

8147 (M) (P)

☒ E27 / 1x max. 25W
IP44 • 19607
matte black/white



5 362250 021473

8148 (M) (P)

☒ E27 / 1x max. 25W
IP44 • 19607
matte black/white



5 362250 021480

LISBON



7826

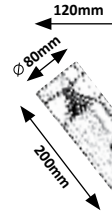

7827

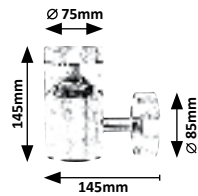

7829

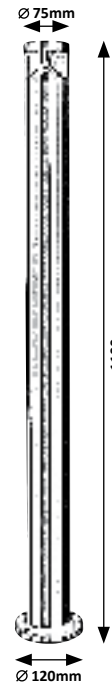

7828

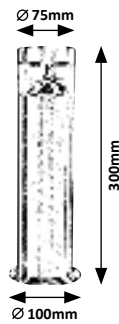

7826

(M P)

LED / 7W
(560lm, 4000K) incl.
IP54
satin chrome/transparent



5 958253 37826

7827

(M P)

LED / 7W
(560lm, 4000K) incl.
IP54
satin chrome/transparent



5 958253 37827

7828

(M P)

LED / 7W
(560lm, 4000K) incl.
IP54
satin chrome/transparent



5 958253 37828

7829

(M P)

LED / 7W
(560lm, 4000K) incl.
IP54
satin chrome/transparent



5 958253 37829



DETROIT



8141

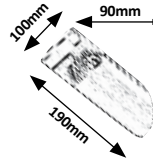

8142

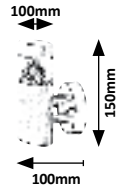

8143



8144

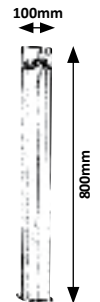

8141 (M) (P)

LED / 6W
(450lm, 4000K) incl.
IP44
satin chrome/transparent



S 36R25C 02' 411

8142 (M) (P)

LED / 6W
(450lm, 4000K) incl.
IP44
satin chrome/transparent



S 36R25C 02' 42E

8143 (M) (P)

LED / 6W
(450lm, 4000K) incl.
IP44
satin chrome/transparent



S 36R25C 02' 43E

8144 (M) (P)

LED / 6W
(450lm, 4000K) incl.
IP44
satin chrome/transparent



S 36R25C 02' 44E

ATLANTA



8166

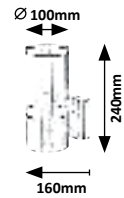

8167

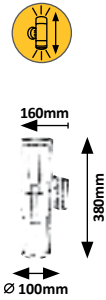

8168



8166 (M) (P)

☒ E27 / 1x max. 60W
IP44
satin chrome/white



8167 (M) (P)

☒ E27 / 2x max. 60W
IP44
satin chrome/white



8168 (M) (P)

☒ E27 / 1x max. 60W
IP44
satin chrome/white





INOX TORCH



8261



8262



8263

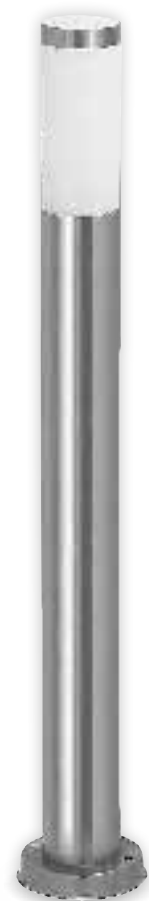

8264

8261 (M) (P)

☒ E27 / 1x max. 25W
IP44 • 9437
satin chrome/white



8262 (M) (P)

☒ E27 / 1x max. 25W
IP44 • 9437
satin chrome/white



8263 (M) (P)

☒ E27 / 1x max. 25W
IP44 • 9437
satin chrome/white



8264 (M) (P)

☒ E27 / 1x max. 25W
IP44 • 9437
satin chrome/white



INOX TORCH



8266

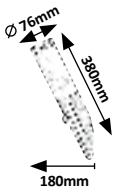

8267

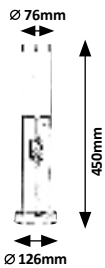

8268

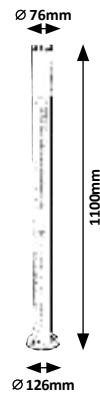

8265

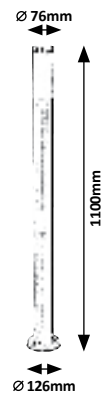

8265 (M) (P)

☒ E27 / 1x max. 25W
IP44 • 9437
satin chrome/white



5 398296 322574

8266 (M) (P)

☒ E27 / 1x max. 25W
IP44 • 9437
☒ 0-5m, 100°
satin chrome/white



5 398296 322571

8267 (M) (P)

☒ E27 / 1x max. 25W
IP44 • 9437
☒ 0-5m, 100°
satin chrome/white



5 398296 322578

8268 (M) (P)

☒ E27 / 1x max. 25W
IP44 • 9437
☒ 0-5m, 100°
satin chrome/white



5 398296 322575

AMARILLO



7969

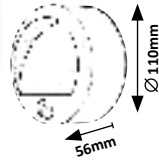

7980

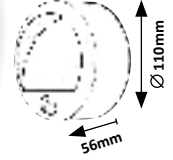

7969



LED / 1,5W (50lm, 3000K) incl.
DC 4,5V • 3xAAA excl.
IP44 • 2-8m, 90°
black/white



5 392250 373292

7980



LED / 1,5W (50lm, 3000K) incl.
DC 4,5V • 3xAAA excl.
IP44 • 2-8m, 90°
white



5 392250 373807



TRENTO



8893



8894



PUEBLO



8011

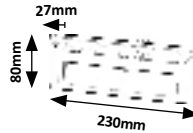

8893

(P)

LED / 3W
(100lm, 4000K) incl.
IP65
white



5 398250 025020

8894

(P)

LED / 3W
(100lm, 4000K) incl.
IP65
anthracite

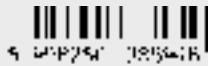

5 398250 025018

8011







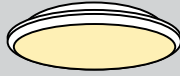

(P)

LED / 1,6W
(103lm, 4000K) incl.
IP65
grey

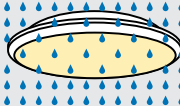

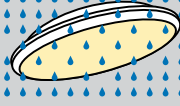
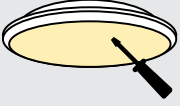
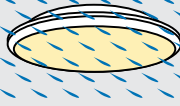
5 398250 025017

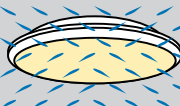
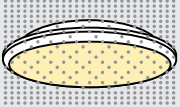
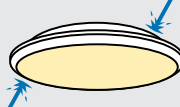
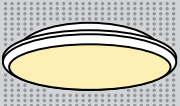
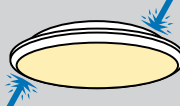
IP RATING • IP VÉDELEM • IP-SCHUTZ

Level of protection • Védelem szintje • Schutzgrad		Level of protection • Védelem szintje • Schutzgrad	
SOLIDS • SZILÁRD TÁRGYAK • FREMDKÖRPER		WATER • VÍZ • WASSER	
	0 EN: No protection. HU: Nincs védelem. DE: Nicht geschützt.		0 EN: No protection. HU: Nincs védelem. DE: Nicht geschützt.
	1 EN: Protected against a solid object greater than 50mm, e.g. a hand. HU: 50 mm vagy nagyobb átmérőjű szilárd tárgyak (pl. kézfej) ellen védett. DE: Geschützt gegen feste Fremdkörper größer als 50 mm (z. B. Handrücken)		1 EN: Protected against vertical water drops. HU: Függőleges irányból leeső vízcseppek ellen védett. DE: Geschützt gegen senkrecht fallendes Tropfwasser
	2 EN: Protected against a solid object greater than 12.5mm, e.g. a finger. HU: 12,5 mm vagy annál nagyobb átmérőjű szilárd tárgyak (pl. ujj) ellen védett. DE: Geschützt gegen feste Fremdkörper größer als 12,5 mm (z. B. Finger)		2 EN: Protected against a 15° angle from normal position. HU: Függőleges irányból leeső vízcseppek ellen védett, a lámpa 15 fokos dőlése mellett. DE: Geschützt gegen Tropfwasser bis 15° zur Senkrechten
	3 EN: Protected against a solid object greater than 2.5mm, e.g. a tool. HU: 2,5 mm vagy annál nagyobb átmérőjű szilárd tárgyak (pl. hegyes szerszám) ellen védett. DE: Geschützt gegen feste Fremdkörper größer als 2,5 mm (z. B. spitze Werkzeuge)		3 EN: Protected against water spray at a 60° angle. HU: Vízpermettől védett legfeljebb 60 fokos szög esetén. DE: Geschützt gegen Sprühwasser bis 60° zur Senkrechten
	4 EN: Protected against a solid object greater than 1.0mm, e.g. a wire. HU: 1 mm vagy annál nagyobb átmérőjű szilárd tárgyak (pl. drót) ellen védett. DE: Geschützt gegen feste Fremdkörper größer als 1 mm (z. B. Draht)		4 EN: Protected against water splashing from any angle. HU: Bármely irányból fröccsenő víz ellen védett. DE: Geschützt gegen Spritzwasser aus allen Richtungen
	5 EN: Dust protected. Prevents ingress of dust sufficient to cause damage. HU: Porvédett. Megakadályozza a károsodás okozásához elegendő mennyiségű por behatolását. DE: Staubgeschützt. Geschützt gegen schädliche Staubablagerungen		5 EN: Protected against water jets from any angle. HU: Vízugarak ellen védett minden irányból. DE: Geschützt gegen Strahlwasser aus allen Richtungen
	6 EN: Dust tight. No ingress of dust. HU: Porálló. A burkolat nem engedi át a port. DE: Staubdicht. Vollständig geschützt gegen Berührung und Eindringen von Staub		6 EN: Protected against powerful water jets and heavy seas. HU: Erős vízugar ellen védett. DE: Geschützt gegen starkes Strahlwasser
			7 EN: Water tight against the effect of temporary immersion in water of a depth between 15cm to 1m for up to 30 minutes. HU: Vízbe merítés ellen védett, ha a lámpát ideiglenesen, legfeljebb 30 perc 15 cm és 1 m közötti mélységű vízbe merítik. DE: Geschützt beim Eintauchen bis zu 30 Minuten bei einer Wassertiefe von 15 cm bis zu 1 m
			8 EN: Water tight against long periods of immersion in water (up to 4m). HU: Folyamatos vízbe merítés káros hatásaitól védett (4 m mélységig). DE: Geschützt beim Untertauchen für längere Periode (bis zu 4 m)

IK CODE • IK-KÓD • IK-CODE

Degree of protection against external mechanical impacts (W), in Joule:

Külső mechanikai igénybevételekkel szembeni védettség(W), Joule-ban • Schutz gegen äußere mechanische Kräfteinwirkungen (W), in Joule:

IK-Code	IK01	IK02	IK03	IK04	IK05	IK06	IK07	IK08	IK09	IK011
W (J)	0.14	0.2	0.35	0.5	0.7	1	2	5	10	2

PERNIK



7250

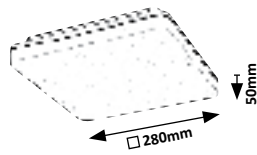

7265

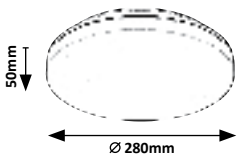

7250



LED / 24W
 (2400lm, 2565lm; 4000K) incl.
 IP54
 black/white



5 908253 372651

7265



LED / 24W
 (2400lm, 2565lm; 3000K) incl.
 IP54
 black/white



5 908253 372655





HORT



7406 (P)

LED / 15W
 (1300lm, 1490lm; 4000K) incl.
 IP54
 white

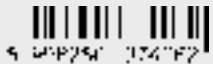

7407 (P)

LED / 15W
 (1100lm, 1350lm; 4000K) incl.
 IP54
 black/white

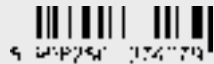

7408 (P)

LED / 15W
 (1300lm, 1490lm; 4000K) incl.
 IP54
 white

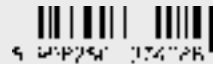

7409 (P)

LED / 15W
 (1100lm, 1350lm; 4000K) incl.
 IP54
 black/white

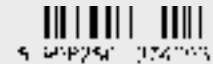

ZENON



2697

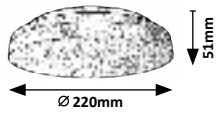

2698

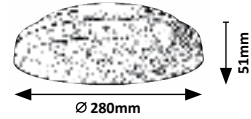

2699

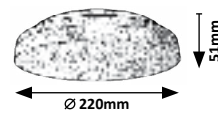

2700

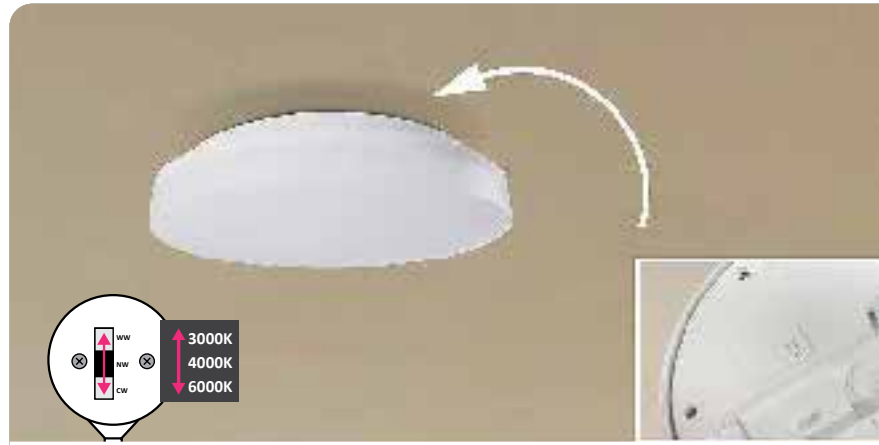
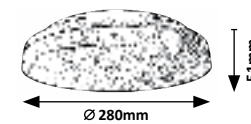

2697

(P)

LED / 18W
(1800lm, 3000K-4000K-6000K) incl.
IP54
white



5 90250 326979

2698

(P)

LED / 24W
(2400lm, 3000K-4000K-6000K) incl.
IP54
white



5 90250 326976

2699

(P)

LED / 18W
(1800lm, 3000K-4000K-6000K) incl.
IP54 • 10m, 36°
white



5 90250 326993

2700

(P)

LED / 24W
(2400lm, 3000K-4000K-6000K) incl.
IP54 • 10m, 36°
white

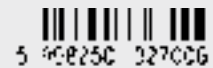

5 90250 327006

HITURA



77028

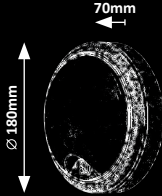

77029

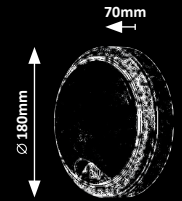

ERIC



7979

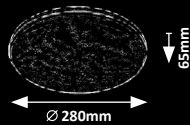

LENTIL



5810

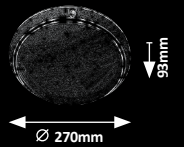

77028

(P)

LED / 15W
(1350lm, 1800lm; 4000K) incl.
IP54 • 6±2m, 120°
black/white

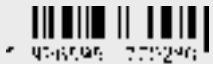

4018706 77028

77029

(P)

LED / 15W
(1500lm, 1800lm; 4000K) incl.
IP54 • 6±2m, 120°
white



4018706 77029

7979

(P)

LED / 24W
(2160lm, 4000K) incl.
IP64
white



5 362256 373791

5810

(P)

E27 / 1x max. 60W
IP54
white



5 362256 355100

DROP LIGHT



I454

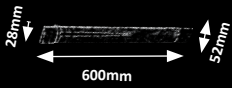

I455

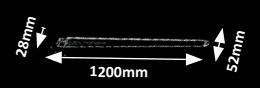

I454



LED / 20W
(1600lm, 4000K) incl.
IP65
white



I455



LED / 40W
(3200lm, 4000K) incl.
IP65
white



KROBIA



7814

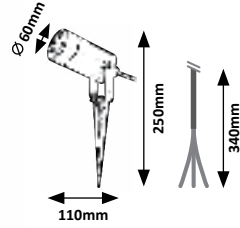

SOLAR 1



8365



TURDA



7060

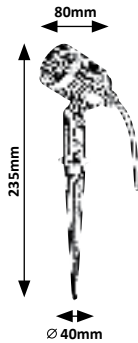

8366

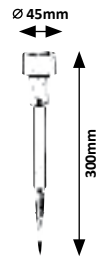

7814

P

☒ GU10 / 1x max. 4W
IP65
black/transparent



7060

P

☒ LED / 3W
(☒260lm, ☒360lm; 4000K) incl.
IP65
black/transparent



8365

P

☒ LED / 0,1W incl.
DC 1,2V 40mAh incl.
IP44
black



8366

M P

☒ LED / 0,1W incl.
DC 1,2V 40mAh incl.
IP44
satin chrome



DANNET

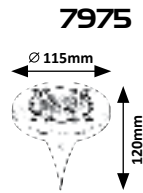

7975

HAITI

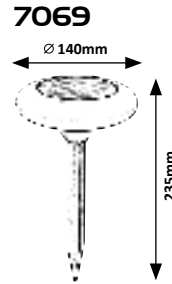

7069

TACOMA

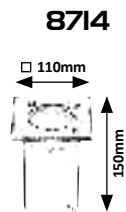

8714

BILBAO

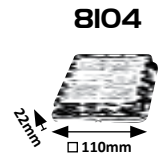

8104

7069



7975 (M) (P)

LED / 0,24W
(20lm, 3000K)
DC 1,2V 400mAh incl. • IP44
satin chrome/ black



5 398250 373713

7069 (P)

LED / 0,5W
(10lm, 12lm) incl.
DC 3,7V 1200mAh incl. • IP65
black/white



5 408250 370609

8714 (M) (G)

GU10 / 1x max. 50W
IP65
satin chrome



5 398250 327147

8104 (P)

LED / 0,2W (4000K) incl.
DC 3,2V 500mAh incl.
IP67
black



5 398250 327116



ROGOVA



77022

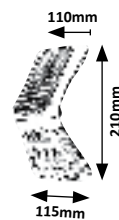

OPAVA



7970

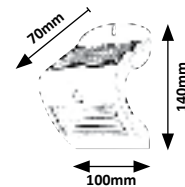

77022 **(P)**

LED / 4W (330lm, 400lm; 4000K) incl.
 DC 3,7V 1800mAh incl.
 IP44 • 6±2m, 120°
 white



5 962250 77022

7970 **(P)**

LED / 2W (115lm, 4000K) incl.
 DC 3,7V incl. • 1x18650 incl.
 IP44 • 2-8m, 90°
 white



5 962250 7970

OSTRAVA



7880

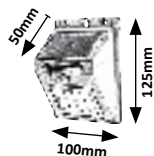

7881

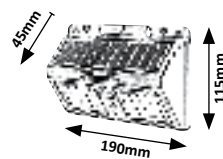

7880



LED / 1,3W (100lm, 4000K) incl.
 DC 3,7V incl. • 1x18650 incl.
 IP44 • 0-3m, 120°
 black



S 362250 375800

7881



LED / 2,4W (225lm, 4000K) incl.
 DC 3,7V incl. • 2x18650 incl.
 IP44 • 0-3m, 120°
 black



S 362250 375807



NARMADA



77004

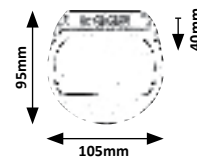

QESA



77005

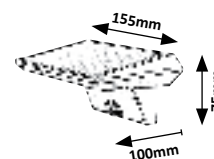

KAPUAS



77015

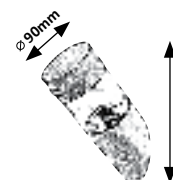

77004 (P)

LED / 0,5W
 (13lm, 20lm; 4000K) incl.
 DC 1,2V 600mAh incl. • IP44
 black/white



77005 (P)

LED / 10W (460lm, 800lm; 4000K) incl.
 DC 3,7V 1200mAh incl.
 IP44 • 3-5m, 120°
 black/white



77015 (M P)

LED / 1,5W (100lm, 130lm; 4000K) incl.
 DC 3,7V 600mAh incl.
 IP44 • 5-8m, 120°
 black/transparent



ZREBAR

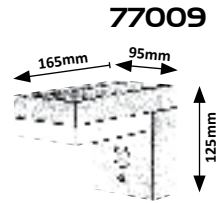

77009, 77010, 77023

Mode A

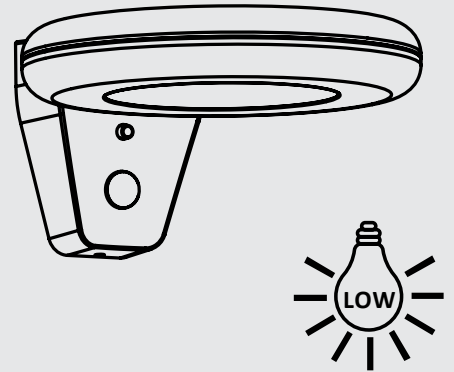

CERTOVO

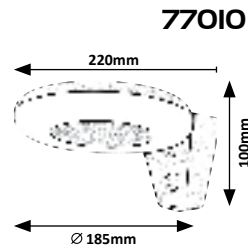

Mode B

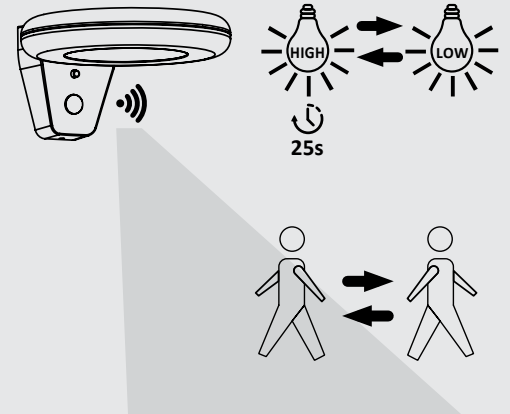

KORANA

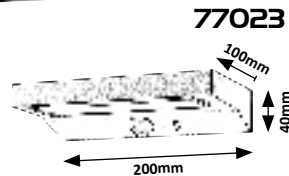

Mode C

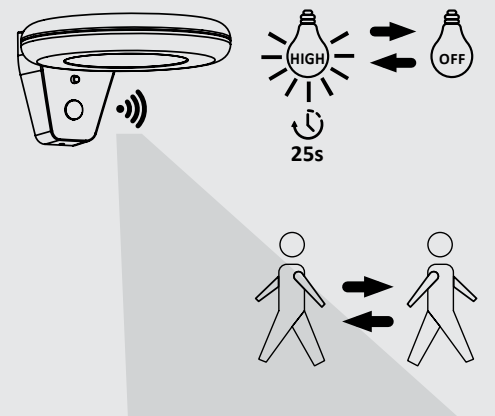

77009 (M) (P)

LED / 6W (450lm, 600lm; 4000K) incl.
DC 3,7V 2200mAh incl.
IP44 • 8m, 90°
black/white



77010 (M) (P)

LED / 4W (360lm, 600lm; 4000K) incl.
DC 3,7V 2200mAh incl.
IP44 • 6±2m, 110°
black/white



77023 (M) (P)

LED / 6W (450lm, 600lm; 4000K) incl.
DC 3,7V 2200mAh incl.
IP44 • 8m, 90°
black/white



77006



BREZNO



77006

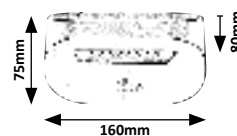

MOSELLE



77014



77014

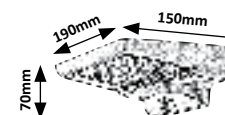

77006

P

LED / 3,2W (145lm, 200lm; 4000K) incl.
DC 3,7V 1200mAh incl.
IP44 • 3-5m, 120°
black/white



77014

P

LED / 4W (300lm, 350lm; 4000K) incl.
DC 3,7V 1500mAh incl.
IP44 • 5-8m, 120°
black/transparent



ALASKA



77017

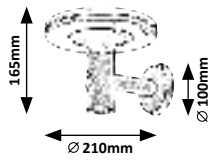

77018

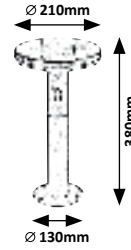

KANGTON



77024

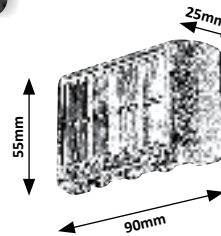

77017 (M) (P)

LED / 10W (250lm, 300lm; 4000K) incl.
DC 3,7V 2500mAh incl.
IP44 • 5-8m, 120°
anthracite/white



77018 (M) (P)

LED / 10W (250lm, 300lm; 4000K) incl.
DC 3,7V 2500mAh incl.
IP44 • 5-8m, 120°
anthracite/white



77024 (P)

LED / 1,2W (8lm, 20lm; 3000K) incl.
DC 1,2V 600mAh incl. • IP44
black



770II



2in1



SEPIK



770IB

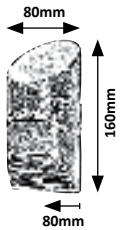

ZLARIN



770I2

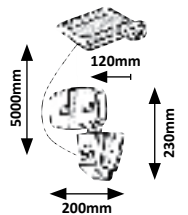

KELNA



770II

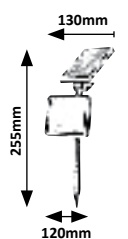

770IB

P

LED / 3,6W (150lm, 260lm; 4000K) incl.
DC 3,7V 1800mAh incl.
IP44 • 3-5m, 120°
black/white



770I2

P

LED / 12W (700lm, 800lm; 4000K) incl.
DC 3,7V 4000mAh incl.
IP44 • 5-8m, 120°
black/white



770II

P

LED / 9,6W (200lm, 240lm; 4000K) incl.
DC 3,7V 2000mAh incl. • IP44
black/white



DOJRAN



77021

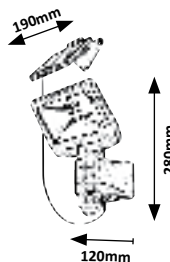

77012



VALPOVO



77019

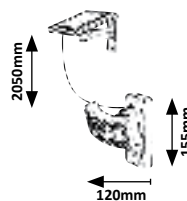

LIHULL



77020

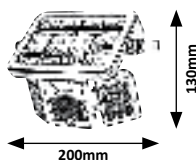

77021



LED / 5W (500lm, 550lm; 4000K) incl.
DC 3,7V 2500mAh incl.
IP44 • 3-10m, 180°
black/transparent



5 351523 77021

77019



LED / 2,4W (250lm, 300lm; 4000K) incl.
DC 3,7V 1200mAh incl.
IP44 • 5-8m, 120°
black/transparent



5 351523 77019

77020



LED / 9,6W (500lm, 600lm; 4000K) incl.
DC 3,7V 3000mAh incl.
IP44 • 5-8m, 120°
black/transparent



5 351523 77020



WIGRY

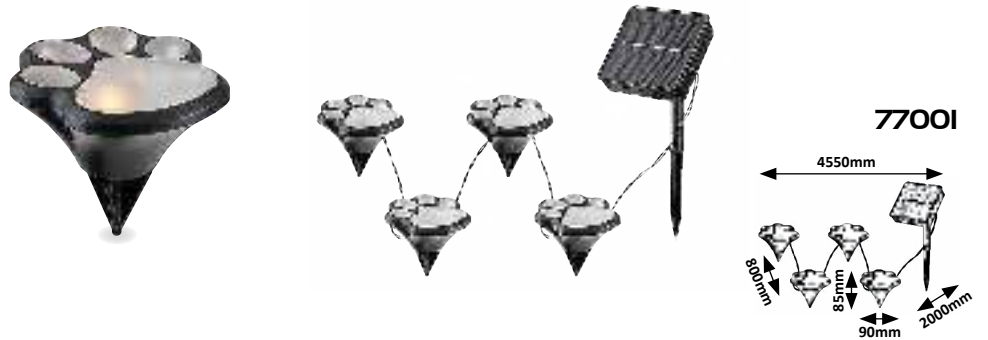

BOBUS

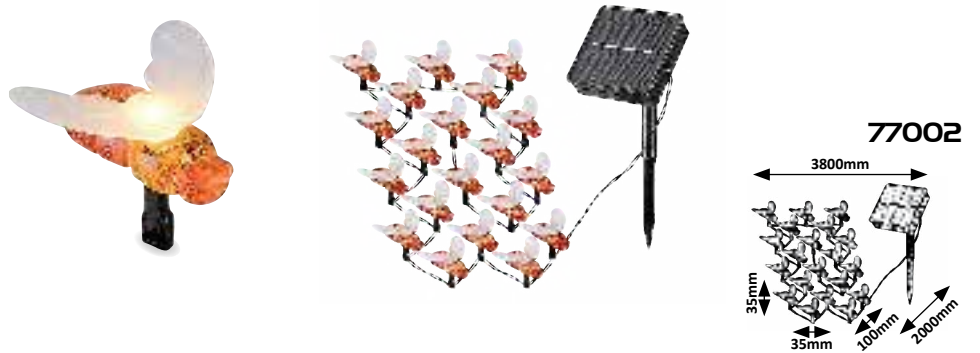

XIMPU



77001 (P)

LED / 0,06W
 (3lm, 8lm; 3000K) incl.
 DC 1,2V 600mAh incl. • IP44
 black/white



77002 (P)

LED / 0,06W
 (3lm, 8lm; 2700K) incl.
 DC 1,2V 600mAh incl. • IP44
 black/white



77003 (P)

LED / 0,1W
 (5lm, 10lm; 2700K) incl.
 DC 1,2V 1200mAh incl. • IP44
 black/white



SKADAR



77007

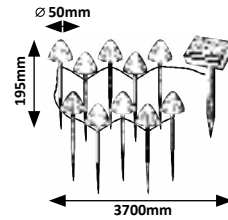

TREPPIO



77008

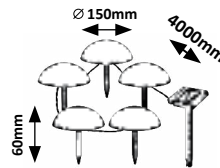

ANSOO



77016

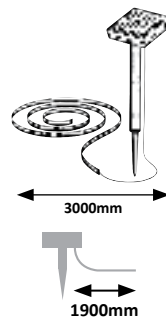

77001



77002

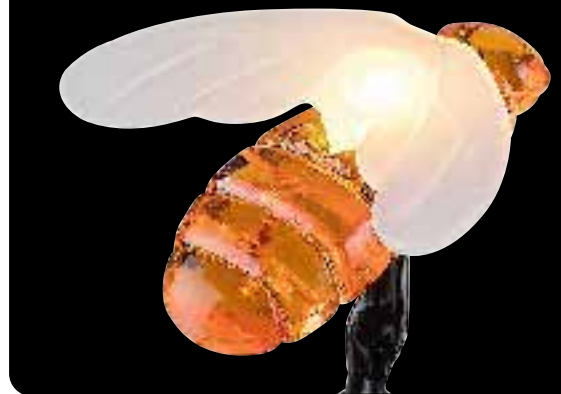

77016



77007



LED / 2W
 (1,2lm, 12lm; 2600K) incl.
 DC 1,2V 300mAh incl. • IP44
 black/white



77008



LED / 1W
 (1,2lm, 6lm; 4000K) incl.
 DC 1,2V 600mAh incl. • IP44
 black/white



77016



LED / 0,26W
 (30lm, 35lm; 3000K) incl.
 DC 3,2V 400mAh incl. • IP44
 white





ODERA



7040

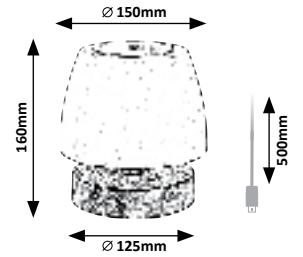

MEDULIN



7032

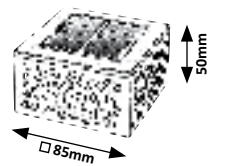

LENTULA



7010

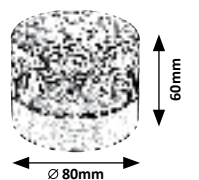

7040

P

LED / 3W
 (140lm, 360lm; 3000K) incl.
 DC 3,7V 2000mAh incl. • IP44
 black/white



7032

G P

LED / 0,5W
 (8lm, 10lm; 3000K) incl.
 DC 1,2V 600mAh incl. • IP44
 black/white



7010

M P

LED 0,5W
 (10lm, 12lm; 3000K) incl.
 1xAA 1,2V 600mAh incl. • IP44
 chrome/transparent



MORA



8948

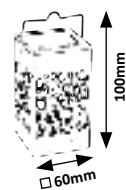

8949

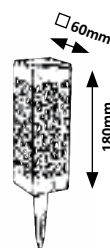

FUNGHETTO



7877

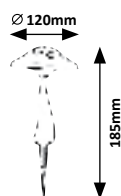

YOLA



7850

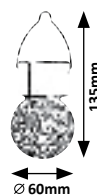

8949



8948

P

LED / 0,07W
(1lm, 3000K) incl.
DC 1,2V 200mAh incl. •
IP23 • black



S 36225C 223420

8949

P

LED / 0,16W
(2lm, 3000K) incl.
DC 1,2V 200mAh incl. •
IP23 • black



S 36225C 223493

7850

M G

RGB LED / 0,06W
DC 1,2V 60mAh incl.
IP44 •
satin chrome/transparent



S 36225C 275503

7877

P

LED / 0,06W
(3000K) incl.
DC 1,2V 300mAh incl. •
IP44 • red/white



S 36225C 275770

FLOOD



7063

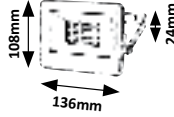

7065

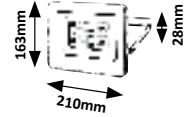

7062

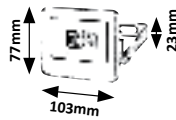

7064

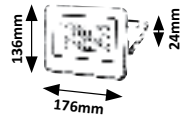

OFF



ON

7062 (M P)

LED / 10W
(1100lm, 4000K)
AC 230V incl. • IP65
black



7063 (M P)

LED / 20W
(2200lm, 4000K)
AC 230V incl. • IP65
black



7064 (M P)

LED / 30W
(3300lm, 4000K)
AC 230V incl. • IP65
black



7065 (M P)

LED / 50W
(5500lm, 4000K)
AC 230V incl. • IP65
black



FLOOD



7066 (M) (P)

LED / 10W (900lm, 4000K)
AC 230V incl. • IP44
4-10m, 120°
black



7067 (M) (P)

LED / 20W (1800lm, 4000K)
AC 230V incl. • IP44
4-10m, 120°
black



7068 (M) (P)

LED / 30W (2700lm, 4000K)
AC 230V incl. • IP44
4-10m, 120°
black



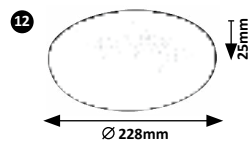

1 9999 **2** **M T**

3 LED / 50W (3080lm, 3000K-6000K) incl.

4 E27 / 1x max. 60W

5 **6** **7**
IP20 • 19500 • 523

8 **9**
• DC 1,2V • 1xAA incl.

10
white



- 1**
- Item No.
 - cikkszám
 - Artikelnummer
 - no. article
 - objednací číslo
 - Číslo položky
 - nr artykułu
 - номер виробу
 - nr. Articol
 - Br. Artikla
 - broj artikla
 - številka artikla / artikel št.
 - № на артикул
 - elemento Nr.
 - izstrādājuma Nr.
 - toote Nr.

- 2**
- material of the product
 - a termék anyaga
 - Material des Produkts
 - matériau du produit
 - materiál výrobku
 - material výrobku
 - Material produktu
 - материал виробу
 - materialul produsului
 - materijal proizvoda
 - materijal proizvoda
 - material izdelka
 - материал на продукта
 - produkto medžiaga
 - produkta materiāls
 - toote materjal

- 3**
- technical data of lightsource for lamp
 - a lámpához adott fényforrás műszaki adatai
 - Technische Daten des Leuchtmittels zur Leuchte
 - caractéristiques techniques de l'ampoule du luminaire
 - technické údaje světelného zdroje dodávaného s lampou
 - technické údaje zdroja svetla priloženého k lampe
 - dane techniczne źródła światła dostarczonego z lampą
 - технічні дані джерела освітлення для даної лампи
 - datele tehnice ale sursei de lumină pentru lampă
 - tehnički podaci o izvoru svetlosti za lampu
 - tehnički podaci izvora svetlosti koji je priložen uz lampu
 - tehnični podatki vira svetlobe za svetilko
 - технически данни на източника на светлина, приложен към лампата
 - šviestuvo šviesos šaltinio techniniai duomenys
 - lampas gaismas avota tehniskie dati
 - lambi valgusallika tehnilised andmed

- 4**
- the specifications of the lightsource
 - a fényforrásra vonatkozó műszaki adatok
 - Angaben zur Lichtquelle
 - les spécifications de la source lumineuse
 - specifikace světelného zdroje
 - Specifikácie svetelného zdroja
 - Specyfikacja źródła światła
 - технічні характеристики джерела освітлення
 - specificații sursă de iluminat
 - specifikacije svetlosnog izvora
 - specifikacija izvora svetlosti
 - specifikacije svetlobnega vira
 - характеристики на светлинния източник
 - šviesos šaltinio specifikacijos
 - gaismas avota specifikācijas
 - valgusallika tehnilised andmed

- 5**
- IP protection
 - IP védettség
 - IP-Klasse
 - protection IP
 - IP krytí
 - IP ochrana
 - Stopień ochrony IP
 - Клас IP-защиты
 - Protecția IP
 - IP zaštita
 - IP zaštita
 - IP zaščita
 - с IP защита
 - IP klasé
 - IP aizsardzība
 - IP kaitse

- 6**
- article number of the replacement lampshade
 - pótbúra cikkszám
 - Artikelnummer des Ersatz-Lampenschirms
 - numéro d'article de l'abat-jour de remplacement
 - číslo výrobku náhradního stínítka
 - číslo výrobku náhradného tienítka
 - Numer artykułu wymiennego klosza
 - номер виробу запасного абажуру
 - număr de articol pentru abajurul înlocuitor
 - Br. artikla rezervnog abažura
 - broj artikla zamjenskog sjenila
 - številka izdelka nadomestnega senčila
 - № на артикул на допълнителен абажур
 - pakaitinio lempos gaubto prekės numeris
 - rezerves abažūra precēs numurs
 - asenduslambivarju artiklinumber

- 7**
- item number remote controller
 - a távirányító cikkszám
 - Artikelnummer der Fernbedienung
 - numéro d'article de la télécommande
 - Číslo položky dálkového ovladače
 - Číslo položky diaľkového ovládača
 - Numer produktu pilota
 - Номер елемента дистанційного керування
 - Număr articol pe telecomandă
 - Broj stavke daljinskog upravljača
 - Broj stavke daljinskog upravljača
 - Številka izdelka daljinskega upravljalnika
 - Каталоген номер на дистанционното управление
 - Nuotolinio valdymo pulto prekės numeris
 - Tālvadības pults vienuma numurs
 - Puldi artiklinumber

- 8**
- type of switch
 - a kapcsoló típusa
 - Typ des Schalters
 - type d'interrupteur
 - druh vypínače
 - druh vypinača
 - Typ przełącznika
 - тип перемикача
 - tip de comutator
 - tip prekidača
 - vrsta prekidača
 - vrsta stikala
 - тип на ключа
 - jungiklio tipas
 - slēdža tips
 - lüliti tüüp

- 9**
- battery specification
 - elemmel kapcsolatos információk
 - Batteriespezifikation
 - spécifications de la pile
 - specifikace baterie
 - Specifikácia batérie
 - Specyfikacja baterii
 - специфікація акумулятора
 - specificații baterie
 - specifikacija baterije
 - specifikacija baterije
 - specifikacija baterij
 - характеристики на батерията
 - baterijos specifikacijos
 - baterijas specifikācija
 - patarei tehnilised andmed

- 10**
- colour of the product
 - a termék színe
 - Farbe des Produkts
 - couleur du produit
 - barva produktu
 - farba produktu
 - Kolor produktu
 - колір виробу
 - culoarea produsului
 - boja proizvoda
 - boja proizvoda
 - barva izdelka
 - цвят на продукта
 - produkto spalva
 - produkta krāsa
 - toote värv

- 11**
- EAN code
 - EAN-kód
 - EAN-Code
 - code EAN
 - EAN- kód
 - EAN- kód
 - kod EAN
 - kod EAN
 - cod EAN
 - EAN kód
 - EAN- kod
 - EAN koda
 - EAN код
 - EAN kods
 - EAN kods
 - EAN-kood

- 12**
- sizes
 - méretek
 - Maß
 - dimensions
 - rozmery
 - rozmary
 - wymiary
 - розміри
 - mēriņi
 - dimenzije
 - dimenzije
 - mere
 - размери
 - išmatavimai
 - izmēri
 - suurused

COLOURS • SZÍNEK • FARBEN



alabaster	alabástrom	Alabasterglas	verre albâtre	alabastrové sklo	alabastrové sklo	szkło alabastrowe	алебастрове скло
amber	borostyán	Bernstein	ambre	jantar	jantár	bursztynowy	бурштиновий
anthracite	antracit	Anthrazit	anthracite	antracitová	antracit	antracyt	антрацитовий
antique bronze	antik bronz	Antik Bronze	bronze antique	antická bronz	antický bronz	brąz antyczny	антична бронза
antique brown	antik barna	Antikbraun	brun antique	antická hnědá	antická hnedá	brąz antyczny	антично коричневий
antique gold	antik arany	Antikgold	or antique	antická zlatá	antická zlatá	złoto antyczne	антично золотий
antique silver	antik ezüst	Antiksilber	argent antique	antický stříbrná	antická strieborná	srebrny antyczny	антично срібний
antique white	antik fehér	Antik Weiß	blanc antique	antikovaná bílá	antická biela	biały antyk	античний білий
beech	bükk	Buche	hêtre	buk	buk	buk	бук
beige	bézs	Beige	beige	Bežová	běžová	Beżowy	беж
black	fekete	Schwarz	noir	černá	čierna	czarny	чорний
blue	kék	Blau	bleu	modrá	modrá	niebieski	синій
bronze	bronz	Bronzefarbig	bronze	bronzová	bronzová	brąz	бронзовий
brown	barna	Braun	brun	Hnědá	hnedá	Brązowy	коричневий
brushed aluminium	súrolt alumínium	gebürstetes Aluminium	aluminium brossé	broušený hliník	kartáčovaný hliník	szczotkowane aluminium	полірований алюміній
champagne	pezsgő	Champagner	champagne	šampaňská barva	šampaňská farba	szampański	колір шампанського
cherry	cseresznye	Kirsche	cerisier	třešeň	čerešňa	czereśniowy	черешня
chrome	króm	Chrome	chrome	chromová	chrómová	chrom	хромовий
claret	bordó	Bordeauxrot	bordeaux	bordó	bordová	bordowy	бордовий
cocoa	kakaó	Kakao	cacao	kakaová	kakao	kakaowy	Какао
coffee	kávé	kaffeefarben	café	káva	káva	kawa	кава
copper	réz	Kupfer	cuivre	měděná	medená	miedź	мідь
cream	krém	Cremerfarbig	crème	krémová	krémová	kremowy	крем
crystal	kristály	Kristall	cristal	krystal	kryštál	kryształ	кристал
gold	arany	Gold	dorée	zlatá	zlatá	złoty	золотий
gold foil	arany fólia	Goldfolie	feuille d'or	zlatá fólie	zlatá fólia	złota folia	золота плівка
golden ochre	aranyokker	goldocker	ocre doré	zlatá okrová	oker zlatý	złota ochra	охра золотиста

COLOURS • SZÍNEK • FARBEN



sticlă alabastru	alabastar staklo	alabastar staklo	alabastrno steklo	алабастрово стъкло	rīsu akmens stikls	rīsu akmens stikls	riisikivi klaas
galben de chihlimbar	bršljan	bršljan	bršljan	кехлибарено	gintaras	dzintars	merevaigukollane
antracit	antracit	antracit	antracitna	антрацитен	antracito pilka	antracīta pelēks	hall antratsiit
bronz antichizat	staro bronzano	antikno bronca	antično bronasta	антично бронзов	antikos bronzinē	antīka bronza	antiik-pronks
maro antic	staro smeđa	staro smeđe	starano rjav	антично кафјав	antikos ruda	antīki brūns	antiik-pruun
auriu antic	staro zlato	staro zlato	staro zlato	антично златен	antikos auksinē	antīks zelts	antiik-kuld
argintiu antic	staro srebro	staro srebro	staro srebro	антично сребърен	antikos sidabrinē	antīks sudrabs	antiik-hõbe
alb antichizat	antik bela	antik bijela	antik bela	антично бяло	antikos balta	antīki balts	antiik-valge
fag	bukva	bukva	bukev	бук	buko	dižskābardis	põök
bej	bež	bež	bež	бежов	smēlio	bēšs	beež
negru	crno	crno	črno	черен	juoda	melns	must
albastru	plavo	plavo	modro	син	mēlyna	zils	sinine
bronz	bronzano	brončano	bronasto	бронзов	bronzinē	bronzas	pronks
maro	smeđa	braun	rjavo	кафјав	ruda	brūns	pruun
aluminium şlefuit	brušeni aluminijum	strugani aluminij	brušen aluminij	драскан алуминий	braižyto aliuminio	matēts alumīnijs	harjatud alumiinium
culoarea sampanie	boja şampanjca	boja şampanjca	barva şampanjca	шампанско	şampano	şampanieša krāsa	şampanja
cireş	treşnja	treşnja	čeşnja	череша	vyšnios	ķirsis	kirss
crom	hrom	krom	krom	хром	chrominē	hroms	kroom
bordo	bordo	bordo	bordo	бордо	tamsiai raudona	tumšsarkana krāsa	bordoo
cacao	kakao	kakao	kakav	какао	kakavos	kakao	kakao
cafea	kafa	kava	kava	кафе	kafija	kavos	kohv
cupru	bakren	bakren	baker	медна	vario	varš	vask
crem	krem	krem	krem	крем	kreminē	krēma krāsa	koor
cristal	kristal	kristal	kristal	кристал	krištolas	kristāls	kristalne
auriu	zlatno	zlatno	zlato	златен	auksinē	zelta	kuldne
folie aur	zlatna folija	zlatna folija	zlata folija	златно фолио	auksinē folija	zelta folija	kuldne foolium
ocru auriu	zlatni oker	zlatni oker	oker zlata	охра златна	auksinē ochra	zeltainais okers	kuldne ooker

COLOURS • SZÍNEK • FARBEN



GBR



HUN



GER



FRA



CZE



SVK



POL



UKR

green	zöld	Grün	vert	zelená	zelená	zielony	зелений
grey	szürke	Grau	gris	šedá	šedá	popielaty	сірий
matte black	matt fekete	Mattschwarz	noir mat	matná černá	matná čierna	czarny matowy	матово-чорний
matte white	matt fehér	Mattweiss	blanc mat	matná bílá	matná biela	biały matowy	матово-білий
metal brown	metál barna	metallbraun	brun métallisé	metal hnědá	hnedá metalíza	brązowy metalik	металево-коричневий
mint	menta	minzgrün	menthe	mátová	mätová	miętowy	м'ятний
multicolour	többszínű	Multicolor	multicolore	vícebarevná	viacfarebná	wielokolorowy	багатокольоровий
natural	natúr	Naturfarbig	nature	přírodní	prírodná	naturalny	натуральний
oak	tölgy	Eiche	chêne	dub	dub	dąb	дуб
opal glass	opál üveg	Opalglas	verre opal	opálové sklo	opálové sklo	szkło opalizowane	скло опал
orange	narancs	Orange	orange	oranžová	oranžová	pomarańczowy	помаранчовий
purple	lila	Lila	lilas	fialová	fialová	fioletowy	ліловий
red	piros	Rot	rouge	červená	červená	czerwony	червоний
rose	rózsa	Rosa	rose	růžová	ružová	różowy	рожевий
rose gold	rózsaarany	Roségold	rose doré	růžové zlato	ružové zlato	różowozłoty	рожеве золото
rust effect	rozsdas effekt	Rost Effekt	rouille effet	rezavá efekt	hrdzavá efekt	efekt rdzy	іржавий ефект
satin chrome	szatin króm	Satin-Chromfarbig	chrome satiné	hedvábně lesklá chro- mová	saténová chrómová	chrom satyna	сатиново хромовий
silver	ezüst	Silber	argent	stříbrná	strieborná	srebrny	срібний
silver foil	ezüst fólia	Silberfolie	feuille d'argent	stříbrná fólie	strieborná fólia	srebrna folia	срібна плівка
silver oak	ezüst tölgy	Silbereiche	chêne argenté	stříbrný dub	dub strieborný	srebrny dąb	срібний дуб
tinted colour	füst színű	Rauchfarbig	fumée	dýmová barva	dymová	przydymiony	димчастий
tobacco	dohánybarna	Tabakfarbig	tabac	tabáková	tabako	tabaczkowy	табако
transparent	átlátszó	transparent	transparent	průhledná	priehľadná	przezroczysty	прозорий
walnut	dió	Bisterbraun	noix	ořech	orech	orzechowy	горіх
wenge	sötét barna	Wenge	wenge	hnědočerná, textura dřeva	wenge	wenge	венге
white	fehér	Weiss	blanc	bílá	biela	biały	білий
yellow	sárga	gelb	jaune	žlutá	žltá	żółty	жовтий

COLOURS • SZÍNEK • FARBEN



verde	zeleno	zeleno	zeleno	зелен	žalia	zaļš	roheline
gri	sivo	sivo	sivo	сив	pilka	pelēks	hall
mat negru	mat crno	mat crno	mat črno	мат-черен	matinė juoda	matēti melns	matt must
mat alb	mat belo	mat bijelo	medlobel	мат-бял	matinė balta	matēti balts	matt valge
brun metalizat	metalno braon	metalno smeđa	metalno rjava	кафяв металик	metalinė ruda	metāla brūns	metallikpruun
mentă	menta	menta	meta	мента	mėtinė	piparmētru	münt
multicolor	višebojno	višebojno	večbarvno	многочветен	įvairiaspalvė	daudzkrāsains	mitmevärviline
natur	natur	natur	naravno	натурален	natūrali	dabisks	loomulik
stejar	hrast	hrast	hrast	дъб	ąžuolo	ozols	tamm
sticlă opal	opal staklo	opal staklo	opalno steklo	опалово стъкло	opalinio stiklo	opāla stikls	opaaklaas
portocaliu	narandžasto	naranča	oranžno	оранжев	oranžinė	oranžs	oranž
violet	ljubičasto	ljubičasto	vijoličasto	лилав	violetinė	violets	lilla
roșu	crveno	crveno	rdeče	червен	raudona	sarkans	punane
trandafir	roza	roza	roza	розов	rožinė	sārts	roos
trandafiriu-auriu	ružičasto zlatno	ružičasto zlatna	rose (čebulna) barva	розовозлатна	rožinė auksinė	sārti zeltains	roos-kuldne
rugină efect	rđa efekat	hrđa efekat	videz rje	с ефект на ръжда	rūdžių efektas	rūsas efekts	rooste efekt
crom satin	satenasti hrom	satenasti krom	satenast krom	сатенен-хром	atlaso chrominė	sašina hroms	satiin-kroom
argintiu	srebrno	srebrno	srebrno	сребърен	sidabrinė	sudraba	hõbe
folie argint	srebrna folija	srebrna folija	srebrna folija	сребърно фолио	sidabrinė folija	sudraba folija	hõbedane foolium
stejar argintiu	srebrni hrast	srebrni hrast	srebrni hrast	сребърен дъб	sidabrinis ąžuolas	sudraba ozols	hõbemänd
fumuriu	boje dima	indigo plava	barva dima	прозращо кафяво	su atspalviu	tonēta krāsa	toonitud värv
tabaco	tabaco	tabaco	barva tobaka	тютюнев (табако)	tabako	tabakas	tubakas
transparent	providan	proziran	prozorno	прозрачен	skaidri	caurspīdīgs	läbipaistev
nucă	orah	orah	oreh	орех	riešutmedžio	valrieksta	pähklipuu
wenge	wenge	wenge	venge	венге	tamsiosios miletijos	wenge	wenge
alb	belo	bijelo	belo	бял	balta	balts	valge
galben	žuto	žuto	rumeno	жълт	geltona	dzeltens	kollane

KEY OF SYMBOLS • JELMAGYARÁZAT • ZEICHENERKLÄRUNG



GBR



HUN



GER



FRA



CZE



SVK



POL



UKR

	Key of symbols	Jelmagyarázat	Zeichen- erklärung	Légende	Legenda	Legenda	Objasnenie znakov	позначення умовних
	item number of spare lampshade	pótbúra cikkszám	Artikelnummer Zusatzschirm	no. d'article du globe supplémentaire	položkové číslo náhradního krytu	číslo položky náhradného tienidla	numer indeksu klosza zapasowego	артикульний номер запасного абажура
	external replacement lampshade item number	külső pótbúra cikkszám	Artikelnummer äußerer Zusatzschirm	numéro d'article globe supplémentaire extérieur	položkové číslo vnějšího náhradního krytu	číslo položky vonkajšieho náhradného tienidla	numer indeksu zewnątrznego klosza zapasowego	артикульний номер зовнішнього запасного абажура
	with light source	fényforrással együtt	mit Leuchtmittel	avec source lumineuse	se světelným zdrojem	spolu so svetelným zdrojom	z źródłem światła	разом з джерелом світла
	without light source	fényforrás nélkül	ohne Leuchtmittel	sans source lumineuse	bez světelného zdroje	bez svetelného zdroja	bez źródła światła	без джерела світла
	with switch	kapcsolóval	mit Schalter	avec commutateur	se spínačem	so spínačom	z wyłącznikiem	із перемикачем
	with cable switch	vezetékes kapcsolóval	mit Leitungsschalter	avec commutateur muni de câble	s kabelovým spínačem	so sieťovým spínačom	z włącznikiem kablowym	із дротовим перемикачем
	mounting diameter	beépítési átmérő	Einbaudurchmesser	diamètre encastrement	montážní průměr	priemer zabudovania	średnica montażowa	діаметр для установки
	mounting depth	beépítési mélység	Einbautiefe	profondeur de montage	montážní hloubka	montážna hĺbka	głębokość montażowa	глибина кріплення
	motion sensor	mozgásérzékelő	Bewegungssensor	détecteur mouvement	senzor pohybu	senzor pohybu	czujnik ruchu	датчик руху
	remote controller item number	távírányító cikkszám	Artikelnummer der Fernbedienung	numéro d'article de la télécommande	Číslo položky dálkového ovládače	Číslo položky dialkoveho ovládača	Numer produktu pilota	Номер елемента дистанційного керування
	Lumen with shade	Lumen adat burával	Lumen mit Schatten	Lumen avec abat-jour	Lumen se stíněním	Lumen s odtieňom	Lumen z cieniem	Люмен з плафоном
	Lumen without shade	Lumen adat búra nélkül	Lumen ohne Schatten	Lumen sans abat-jour	Lumen bez stínu	Lumen bez tieňa	Światło bez cienia	Люмен без тіні



ROM



SRB



CRO



SLO



BUL



LTU



LVA



EST

	Legendă	Objasnenje znakova	Tumač znakova	Legenda	Обяснение на условни знаци	Aprašas	Apzīmējumi	Tingmärk
	număr articol abajur suplimentar	oznaka dodatnog abažura	oznaka dodatnog sjenila	koda dodatnega abažura	резервен абажур артикулен №	atsarginio gaubto prekės Nr.	maiņas abažūra izstrādājuma Nr.	asenduslambikuppel nr
	număr articol abajur suplimentar pentru exterior	oznaka dodatnog spoljnog abažura	oznaka dodatnog vanjskog sjenila	oznaka dodatnega zunanjega abažura	външен резервен абажур артикулен №	išorinio atsarginio gaubto prekės Nr.	ārējā maiņas abažūra izstrādājuma Nr.	välise asenduslambikuppel nr
	cu sursă de lumină	zajedno sa izvorom svetlosti	zajedno s izvorom svjetlosti	skupaj z virom svetlobe	включително светлинен източник	kartu su šviesos šaltiniu	kopā ar gaismas avotu	koos valgusalikaga
	fără sursă de lumină	bez izvora svetlosti	bez izvora svjetlosti	brez svetlobnega vira	без светлинен източник	be šviesos šaltinio	bez gaismas avota	valgusalikata
	cu întrerupător	sa prekidačem	s prekidačem	s stikalom	с превключвател	su jungikliu	ar slēdzi	lūlitiga
	cu întrerupător pe cablu	sa kablovskim prekidačem	s kablovskim prekidačem	s kabelskim stikalom	с кабелен превключвател	su kabelio jungikliu	ar slēdzi uz vada	sisselülitamise juhtmega
	diametru de montare	dimenzije ugradnje	instalacijske dimenzije	dimenzije montaže	диаметър на вграждане	įmontavimo diametras	ie būvēts diametrs	sisseehitatud diameeter
	adâncimea de montare	dubina ugradnje	instalacijske ugradnje	globina montaže	дълбочина на монтаж	įmontavimo gylis	ie būvēts dziļums	sisseehitatud sügavus
	senzor de mișcare	senzor kretanja	senzor kretanja	senzor gibanja	със сензор за движение	judesio jutiklis	kustības sensors	liikumisandur
	Număr articol pe telecomandă	Broj stavke daljinskog upravljača	Broj stavke daljinskog upravljača	Številka izdelka daljinskega upravljalnika	Каталожен номер на дистанционното управление	Nuotolinio valdymo pulto prekės numeris	Tālvadības pults vienuma numurs	Puldī artiklinumber
	Lumen cu umbră	Lumen sa senkom	Lumen sa sjenom	Lumen s senco	Люмен със сянка	Lumenas su šešėliu	Lūmenis ar ēnu	Varjuga luumen
	Lumen fără umbră	Lumen bez senke	Lumen bez sjene	Lumen brez sence	Люмен без сянка	Lumenas be šešėlio	Lūmenis bez ēnas	Valendik ilma varjuta

KEY OF SYMBOLS • JELMAGYARÁZAT • ZEICHENERKLÄRUNG



GBR



HUN



GER



FRA



CZE



SVK



POL



UKR

	Lamp made of	Lámpa anyaga	Lampenmaterial	Le matériel de la lampe	Materiál lampy	Materiál svetidla	Materiał oprawy	Матеріал світильника
M	metal	fém	Metall	métal	kov	kov	metal	метал
W	wood	fa	Holz	bois	dřevo	drevo	drewno	дерево
G	glass	üveg	Glas	verre	sklo	sklo	szkło	скло
AC	acrylic crystal	akril kristály	Acrylkristall	cristal acrylique	akrylový křišťál	akrylový kryštál	kryształ akrylowy	акриловий криштал
GC	glass crystal	üveg kristály	Glaskristall	cristal de verre	skleněný křišťál	sklo křišťál	kryształ szklany	криштал
P	plastic	műanyag	Kunststoff	plastique	plast	umelá hmota	tworzywo sztuczne	пластмаса
A	acrylic	akril	Acryl	acrylique	akryl	akryl	akryl	акрил
PA	paper	papír	Papier	papier	papír	papier	papier	папір
C	ceramics	kerámia	Keramik	céramique	keramika	keramika	ceramika	кераміка
T	textile	textil	Textil	textile	textil	textília	tkanina	текстиль
S	rock salt	kősó	Steinsalz	sel gemme	kamenná sůl	kamenná soľ	sól kamienna	кам'яна сіль
SI	silicon	szilikon	Silikon	silicone	silikon	silikón	silikon	силиконові
PL	plaster	gipsz	Stuck	plâtre	sádra	sadra	gips	гіпс
RA	rattan	rattan	Rattan	rotin	ratan	ratan	ratan	ротанг

	Further key	Egyéb magyarázat	Weitere Erklärungen	Autres explications	jiné vysvětlení	druga razlaga	inne wytłumaczenie	інше пояснення
excl.	excluded	nem tartalmaz	exklusive	excepté	neobsahuje	neobsahuje	nie zawiera	не містить
incl.	included	tartalmaz	inklusive	inclus	obsah	obsahuje	zawiera	містить



ROM



SRB



CRO



SLO



BUL



LTU



LVA



EST

	Materialul lămpi	Materijal svetiljke	Materijal rasvjetnog tijela	Material izdelka	Лампата е произведена от	Šviestuvo medžiaga	Lampas materiāls	Lambi materjal
M	metal	metal	metal	kovinski	метал	metalinė	metāla	metalli
W	lemn	drven	drvo	les	дърво	medis	koksne	puit
G	sticlă	staklo	staklo	steklo	стъкло	stiklas	stikls	klaas
AC	cristal acrilic	akrilni kristal	akrilni kristal	akrilni kristal	акрилен кристал	akrilinis kristalas	akrila kristāls	akrüülkristall
GC	cristal de sticlă	stakleni kristal	stakleni kristal	stekleni kristal	стъклен кристал	stiklinis kristalas	stikla kristāls	klaaskristall
P	plastic	plastična	plastika	umetna masa	пластмаса	plastikas	plastmasa	plast
A	acril	akril	akril	akril	акрил	akrilas	akrils	akrüül
PA	hîrtie	od papira	papir	papir	хартия	popierius	papīrs	paber
C	ceramică	keramika	keramika	keramika	керамика	keramikinis	keramika	keraamika
T	textile	tekstil	tekstil	tekstil	текстиль	tekstilė	tekstilmateriāls	tekstiil
S	sare gemă	kamena so	kamena sol	kamena sol	каменна сол	akmens druska	akmeņsāls	kivisool
SI	silicon	silikon	silikon	silikon	силиконна	silicis	silīcijs	rāni
PL	ghips	gips	žbuka	mavec	гипс	gipsas	ģipsis	kipskrohvisegu
RA	trestie indiană	ratan	ratan	ratan	ратан	rotangas	rotangpalma	rotang

	alte explicații	Druga objašnjenja	Druga objašnjenja	iné vysvetlenie	други обяснения	Kiti simboliai	Citi simboli	Muud sümbrid
excl.	nu conține/ne este inclus	ne sadržava	Ne sadrži	brez (ne vsebuje)	не е включено	neturi	nesatur	ei sisalda
incl.	conține/include	sadržava	sadržava	vsebujejo	включено е	yra su	satur	sisaldab

KEY OF SYMBOLS • JELMAGYARÁZAT • ZEICHENERKLÄRUNG



	Symbols	Jelölések	Bezeichnungen	Symboles	Jména
	new	új	neu	nouveau	nový
	designed by Rabalux	Rabalux saját design	entworfen von Rabalux	conçu par Rabalux	Rabalux vlastní design
	Lightsource recommendation	Fényforrás ajánló	Lichtquellenempfehlung	Recommandation de source lumineuse	Doporučení světelného zdroje
	additional products / family members can be found on page X.	kiegészítő termékek/további családtagok az X. oldalon	weitere Produkte (der Serie) finden Sie auf Seite X.	des produits / membres de la famille supplémentaires se trouvent à la page X	další produkty / členy rodiny naleznete na straně X.
	5 years guarantee	5 év garancia	5 Jahre Garantie	5 ans de garantie	záruka 5 let
	built-in LED	beépített LED	LED inklusive	LED inclus	obsahuje LED
	LED included	LED-et tartalmaz	LED inklusive	LED inclus	obsahuje LED
	Smart product	Okos termék	intelligentes Produkt	produit intelligent	chytrý produkt
	warm white light	meleg fehér fényű	warmweiß	blanc chaud	teplá bílá
	natural white light	természetes fehér fényű	naturweiß	blanc naturel	přirozená bílá
	cool white light	hideg fehér fényű	kaltweiß	blanc froid	studená bílá
	variable colour temperature variable	állítható színhőmérséklet	einstellbare Farbtemperatur	température de couleur	spínačem nastavitelná teplota chromatičnosti
	non-adjustable colour temperature	nem állítható színhőmérséklet	nicht einstellbare Farbtemperatur	température de couleur n'est pas réglable	teplota barev bez možnosti nastavení
	colour temperature variable with remote control	távírányítóval állítható színhőmérséklet	Mit fernbedienung einstellbare Farbtemperatur	Température de couleur réglable par télécommande	Nastavení teploty chromatičnosti dálkovým ovladačem
	colour temperature variable with switch	kapcsolóval állítható színhőmérséklet	mit Schalter einstellbare Farbtemperatur	température de couleur réglable avec interrupteur	spínačem nastavitelná teplota chromatičnosti
	colour temperature variable with touch switch	érintőkapcsolóval állítható színhőmérséklet	Mit Berührungschalter einstellbare Farbtemperatur	température de couleur variable avec interrupteur tactile	změna teploty barvy světla pomocí dotykového spínače
	Color temperature can be adjusted in 3 steps with a switch	Kapcsolóval 3 lépésben szabályozható színhőmérséklet	Die Farbtemperatur kann mit einem Schalter in 3 Stufen eingestellt werden	La température de couleur peut être ajustée en 3 étapes avec un interrupteur	Teplotu barev lze nastavit pomocí přepínače ve 3 krocích
	Color temperature can be adjusted in three steps with a touch switch	Érintőkapcsolóval három lépésben szabályozható színhőmérséklet	Die Farbtemperatur kann in drei Stufen mit einem Touch-Schalter eingestellt werden	La température de couleur peut être ajustée en trois étapes avec un interrupteur tactile	Teplotu barev lze upravit ve třech krocích dotykovým spínačem
	Color temperature can be adjusted in five steps with a touch switch	Érintőkapcsolóval öt lépésben szabályozható színhőmérséklet	Die Farbtemperatur lässt sich per Touch-Schalter in fünf Stufen einstellen	La température de couleur peut être ajustée en cinq étapes avec un interrupteur tactile	Teplotu barev lze upravit v pěti krocích dotykovým spínačem

KEY OF SYMBOLS • JELMAGYARÁZAT • ZEICHENERKLÄRUNG



	Označenia	Oznaczenia	Позначення	Simboluri	Označavanje
	Nový	nowy	новий	nou	novo
	Rabalux vlastný dizajn	Zaprojektowano przez Rabalux	розроблений Rabalux	designed de Rabalux	Rabalux dizajn
	Odporúčanie svetelného zdroja	Rekomendacja źródła światła	Рекомендація щодо джерела світла	Recomandare sursa de lumina	Preporuka za izvor svetlosti
	ďalšie produkty / členia rodiny nájdete na strane X.	produkty dodatkowe / z tej samej linii można znaleźć na stronie X.	додаткові товари / членів сім'ї можна знайти на сторінці X.	produse suplimentare / membri ai familiei pot fi găsite la pagina X.	Informacije o dodatnim proizvodima / elementima palete proizvoda dostupne su na strani X.
	Záruka 5 rokov	5-letnia gwarancja	гарантія 5 років	5 ani garanție	5 godina garancije
	obsahuje LED diódy	Dioda LED w wyposażeniu	містить світлодіоди	LED încorporat	ugrađeni LED
	obsahuje LED diódy	Dioda LED w wyposażeniu	містить світлодіоди	LED inclus	sa LED diodom
	inteligentný produkt	inteligentny produkt	розумний продукт	produs inteligent	pametnan proizvod
	teplá biela	ciepła biała	теплий білий	alb cald	toplo bela
	prírodná biela	naturalna biała	натуральний білий	alb natural	prirodno bela
	studená biela	zimna biała	холодний білий	alb rece	hladno bela
	možnosť nastavenia teploty farieb spínačom	temperatura barwy regulowana wyłącznikiem	колірна температура, регульована перемикачем	temperatura culorii controlată cu comutator	temperatura boja može da se podesi sa prekidačem
	teplota farieb bez možnosti nastavenia	Nie można regulować temperatury barwowej	колірну температуру не можна регулювати	temperatura de culoare nereglabilă	temperatura boje se ne može podesiti
	Možnosť nastavenia teploty farieb s diaľkovým ovládačom	Zmienna temperatura barwowa za pomocą pilota	Регулювання колірної температури через пульт дистанційного керування	Temperatura culorii reglabilă de la telecomandă	Sa daljinskim prekidačem može da se podesi temperatura boja
	možnosť nastavenia teploty farieb spínačom	temperatura barwy regulowana wyłącznikiem	колірна температура, регульована перемикачем	temperatura culorii controlată cu comutator	temperatura boja može da se podesi sa prekidačem
	nastavitel'ná farebná teplota s dotykovým spínačom	Regulacja temperatury światła za pomocą włącznika dotykowego	Колір світла змінюється доторканням	temperatura variabilă a culorii cu comutator tactil	Temperatura svetla, podesiva putem prekidača na dodir
	Farebnú teplotu je možné nastaviť v 3 krokoch pomocou prepínača	Temperaturę barwową można regulować w 3 krokach za pomocą przełącznika	Колірну температуру можна регулювати в 3 кроки за допомогою перемикача	Temperatura de culoare poate fi reglată în 3 trepte cu un comutator	Температура боје се може подесити у 3 корака помоћу прекидача
	Teplotu farby je možné nastaviť v troch krokoch pomocou dotykového spínača	Temperaturę barwową można regulować w trzech krokach za pomocą przełącznika dotykowego	Колірну температуру можна регулювати в три етапи за допомогою сенсорного перемикача	Temperatura culorii poate fi ajustată în trei pași cu un comutator tactil	Температура боје се може подесити у три корака помоћу прекидача на додир
	Teplotu farby je možné nastaviť v piatich krokoch dotykovým spínačom	Temperaturę barwową można regulować w pięciu krokach za pomocą przełącznika dotykowego	Колірну температуру можна регулювати в п'ять кроків за допомогою сенсорного перемикача	Temperatura culorii poate fi ajustată în cinci trepte cu ajutorul unui comutator tactil	Температура боје може се подесити у пет корака помоћу прекидача на додир

KEY OF SYMBOLS • JELMAGYARÁZAT • ZEICHENERKLÄRUNG



CRO



SLO



BUL



LTU



LVA



EST

	Oznake	Oznake	Символи	Simboliai	Simboli	Sümbolid
	novo	novo	ново	naujas	jauns	uus
	dizajnirao Rablux	zasnoval Rabalux	проектирано от Rabalux	suprojektavo „Rabalux“	izstrādājis Rabalux	Rabaluxi disain
	Preporuka izvora svjetla	Odporúčanje svetelného zdroja	Препоръка за източник на светлина	Šviesos šaltinio rekomendacija	leteikums par gaismas avotu	Valgusallika soovitus
	dotatne proizvode/ članove obitelji moguće je pronaći na stranici X.	dotatne izdelke / družinske člane najdete na strani X.	допълнителни продукти / членове на семейството могат да бъдат намерени на страница X.	papildomų prekių / šeimos narių rasite X puslapyje.	papildu produktus/sērijas modeļus var atrast X lapā.	Leiate lisatooted ja sama tootepere muud tooted leheküljelt X.
	5 godina jamstva	5 let garancije	5 години гаранция	5 metų garantija	5 gadu garantija	5-aastane garantii
	ugrađeni LED	vgrajen LED	вграден LED	įmontuotas LED įrenginys	ieibūvēta LED	sisse-ehitatud LED
	sadrži LED	vsebuje LED	с включен LED	LED pridedama	LED iekļauta komplektā	LED on kaasas
	pametnan proizvod	pameten izdelek	интелигентен продукт	protingas produktas	gudrs produkts	tark toode
	toplo bijelo	toplo bela	топло бяло	šiltai balta	silti balts	soe valge
	prirodno bijelo	naravno bela	естественно бяло	natūraliai balta	dabīgi balts	loomulik valge
	hladno bijelo	hladno bela	студено бяло	šaltai balta	vēsi balts	külm valge
	temperatura boja se može podesiti s prekidačem	barvna temperatura nastavljava s stikalom	регулируема с ключ светлинна температура	jungikliu keičiama spalvos temperatūra	ar slēdzi maināma krāsu temperatūra	lūlītīga regulēritav vārvitemperatuur
	temperatura boje se ne može podesiti	barvno temperaturo ni mogoče prilagoditi	не регулируема цветна температура	nereguliuojama spalvos temperatūra	neregulējama krāsu temperatūra	mitteregulēritav vārvustemperatuur
	Pomoću daljinskog prekidača možete podesiti temperaturu boje	Barvno temperaturo lahko nastavite z daljinskim stikalom	Регулиране на цветната температура с дистанционно управление	Kintanti spalvinė temperatūra su nuotoliniu pulteliu	Maināma krāsu temperatūra ar tālvadības pulti	Muutuv vārvustemperatuur kaugjuhtimisega
	temperatura boja se može podesiti s prekidačem	barvna temperatura nastavljava s stikalom	регулируема с ключ светлинна температура	jungikliu keičiama spalvos temperatūra	ar slēdzi maināma krāsu temperatūra	lūlītīga regulēritav vārvitemperatuur
	Temperatura boje podesiva prekidačem na dodir	sprememba barvne temperature s stikalom na dotik	промянана на цветната температура с докосване	Prilietimu keičiama spalvos temperatūra	Krāsu temperatūras mainīgais ar skārienekrānu	puutelūlītist muudetav vārvitemperatuur
	Temperatura boje može se podesiti u 3 koraka pomoću prekidača	Barvno temperaturo lahko nastavite v 3 korakih s stikalom	Цветовата температура може да се регулира на 3 стъпки с превключател	Spalvos temperatūrą galima reguliuoti 3 žingsniais jungikliu	Krāsu temperatūru var regulēt 3 soļos ar slēdzi	Vārvitemperatuuri saab lūlītīga regulērida 3 astmes
	Temperatura boje može se podesiti u tri koraka pomoću prekidača na dodir	Barvno temperaturo lahko nastavite v treh korakih s stikalom na dotik	Цветовата температура може да се регулира на три стъпки с сензорен превключател	Spalvos temperatūrą galima reguliuoti trimis žingsniais jutikliniu jungikliu	Krāsu temperatūru var regulēt trīs soļos ar skārienslēdzi	Vārvitemperatuuri saab puutelūlītīga kolmes astmes regulērida
	Temperatura boje može se podesiti u pet koraka pomoću prekidača na dodir	Barvno temperaturo lahko nastavite v petih korakih s stikalom na dotik	Цветовата температура може да се регулира в пет стъпки с сензорен превключател	Spalvos temperatūrą galima reguliuoti penkiais žingsniais jutikliniu jungikliu	Krāsu temperatūru var regulēt piecos posmos ar skārienslēdzi	Krāsu temperatūru var regulēt piecos posmos ar skārienslēdzi

KEY OF SYMBOLS • JELMAGYARÁZAT • ZEICHENERKLÄRUNG



GBR



HUN



GER



FRA



CZE



SVK

	Symbols	Jelölések	Bezeichnungen	Symboles	Jména	Označenia
	with switch	kapcsolóval	mit Schalter	avec commutateur	se spínačem	so spínačom
	adjustable brightness in 3 steps with switch	Kapcsolóval 3 lépésben szabályozható fényerő	Einstellbare Helligkeit mit Schalter in 3 Stufen	Luminosité ajustable avec interrupteur à 3 positions	Nastavitelný jas pomocí spínače ve 3 krokách	Nastavitelný jas pomocou spínača v 3 krokoch
	adjustable brightness in 3 steps with touch switch	Érintőkapcsolóval több lépésben szabályozható fényerő	Einstellbare Helligkeit mit Touch-Schalter in 3 Stufen	Luminosité ajustable avec interrupteur tactile à 3 positions	Nastavitelný jas s dotykovým spínačem ve 3 krokách	Nastavitelný jas s dotykovým spínačom v 3 krokoch
	with touch switch	érintőkapcsolóval	mit Berührungsschalter	avec interrupteur tactile	dotykový spínač	s dotykovým spínačom
	touch switch dimmer	érintőkapcsolóval szabályozható fényerő	Touchbutton-Lichtstärkeregler	réglage de la luminosité avec interrupteur tactile	nastavení jasu dotykovým spínačem	dotykový spínač na regulácia intenzity svetla
	light intensity variable only with remote control	csak távirányítóval állítható fényerő	Lichtintensität nur mit Fernbedienung einstellbar	intensité lumineuse variable uniquement avec télécommande	intenzitu světla lze nastavit pouze pomocí dálkového ovládání	možnosť nastavenia intenzity svetla iba s diaľkovým ovládačom
	dimmable	szabályozható fényerő	Lichtstärke Regler	Regleur d'intensité de la lumière	regulátor jasu	regulátor jasu
	Brightness can be adjusted in five steps with a touch switch	Érintőkapcsolóval öt lépésben szabályozható fényerő	Die Helligkeit lässt sich per Touch-Schalter in fünf Stufen regulieren	La luminosité peut être ajustée en cinq étapes avec un interrupteur tactile	Jas lze nastavit v pěti krokách dotykovým spínačem	Jas je možné nastaviť v piatich krokoch dotykovým spínačom
	The use of a dimmable light source is required for the dimmer function	Fényerőszabályozható fényforrás használata szükséges a fényerőszabályozó funkcióhoz	Für die Dimmfunktion ist die Verwendung eines dimmbaren Leuchtmittels erforderlich	L'utilisation d'une source lumineuse dimmable est nécessaire pour la fonction variateur	Pro funkci stmívače je nutné použití stmívatelného zdroje světla	Pre funkciu stmievača je potrebné použitie stmievateľného svetelného zdroja
	RGB colour change LED	RGB színváltós LED	Farbwechsel-LED	LED à changement de couleurs	LED diody střídající barvu	LED s meniacou sa farbou
	Magic RGB	Magic RGB	Magic RGB	RVB magique	Kouzelné RGB	Kúzelné RGB
	Three-step colour adjustment with touch switch	Három lépésben állítható szín érintőkapcsolóval	Dreistufige Farbeinstellung mit Berührungsschalter	Couleur réglable en trois étapes avec interrupteur tactile	Třístupňové nastavení barev pomocí dotykového spínače	Trojstupňové nastavenie farieb pomocou dotykového spínača
	motion sensor	mozgásérzékelő	Bewegungssensor	détecteur mouvement	senzor pohybu	senzor pohybu
	ON/OFF Motion sensor	BE/KI kapcsolható mozgásérzékelő	EIN/AUS Bewegungssensor	Détecteur de mouvement ON / OFF	ZAP. / VYP. pohybový senzor	ZAP. / VYP. Pohybový senzor
	microwave sensor	mikrohullámú mozgásérzékelő	Mikrowellen-Sensor	Capteur à micro-ondes	mikrovlnný snímač	Mikrovlnný snímač
	illuminates upwards	felfelé világít	leuchtet nach oben	éclaire vers le haut	svítí nahoru	svieti nahor
	illuminates downwards	lefelé világít	leuchtet nach unten	éclaire vers le bas	směr svícení dolů	svieti smerom dole
	illuminates downwards and upwards	lefelé és felfelé is világít	leuchtet nach oben und nach unten	éclaire vers le bas et vers le haut	směr svícení nahoru i dolů	svieti smerom dole aj hore
	light reactive, only illuminates in the dark	fényérzékelő lámpa, csak sötétben világít	mit Helligkeitssensor, leuchtet nur im Dunkeln	l'appareil est muni d'un photodétecteur, il ne se manifesterá que s'il est plongé dans l'obscurité	se světelným senzorem, svítí pouze ve tmě	so svetelným senzorem, svieti iba v tme

KEY OF SYMBOLS • JELMAGYARÁZAT • ZEICHENERKLÄRUNG



	Oznaczenia	Позначення	Simboluri	Označavanje	Oznake
	z włącznikiem	із перемикачем	cu întrerupător	sa prekidačem	s prekidačem
	Jasność dostosowywana przełącznikiem w 3 krokach	Регульована яскравість з перемикачем в 3 кроки	Luminozitate ajustabilă prin comutator în 3 trepte	Podesivo osvetljenje u 3 koraka uz pomoć prekidača	Prilagodljiva svjetlina s prekidačem u tri koraka
	Jasność dostosowywana dotykowo w 3 krokach	Регульована яскравість з сенсорним перемикачем в 3 кроки	Luminozitate ajustabilă prin atingere, în 3 trepte	Podesivo osvetljenje u 3 koraka uz pomoć prekidača koji se aktivira dodirom	Prilagodljiva svjetlina s dodirnim prekidačem u tri koraka
	ze ściemniaczem	із сенсорним перемикачем	cu senzor tactil	sa prekidačem na dodir	s dodirnom sklopkom
	ściemniacz dotykowy	сенсорний диммер	senzor tactil pentru reglarea luminozității	podešavanje jačine svetlosti sa prekidačem na dodir	podešavanje svjetline pomoću dodirne sklopke
	nateżenie światła regulowane tylko przy pomocy pilota	інтенсивність світла регулюється тільки за допомогою пульта	Intensitate variabilă a luminii numai de la telecomandă	Intenzitet svetlosti podesiv samo uz pomoć daljinskog upravljača	jačina svetla promjenjiva samo sa daljinskim upravljačem
	regulator nateżenia światła	регулятор потужності світла	regulator intensitate lumina	regulator svetlosti	regulator jačie svjetla
	Jasność można regulować w pięciu krokach za pomocą przełącznika dotykowego	Яскравість можна регулювати в п'ять кроків за допомогою сенсорного перемикача	Luminozitatea poate fi ajustată în cinci trepte cu un comutator tactil	Osvetljenje se može podesiti u pet koraka pomoću prekidača na dodir	Svjetlina se može podesiti u pet koraka pomoću prekidača na dodir
	Do funkcji ściemniacza wymagane jest użycie ściemnianego źródła światła	Для функції диммера потрібне джерело світла з можливістю затемнення	Utilizarea unei surse de lumină reglabilă este necesară pentru funcția de dimmer	Za funkciju zatamnjivanja potrebna je upotreba izvora svetlosti sa mogućnošću prigušivanja	Za funkciju zatamnjivanja potrebna je upotreba izvora svjetlosti koji se može prigušiti
	Zmieniający kolor LED	Світлодіоди зі зміною кольору	LED RGB	LED sa promjenjivim bojama	LED s promjenjivim bojama
	Magia RGB	Чарівний RGB	RGB Magic	Magic RGB funkcija	Čarobni RGB
	Trójstopniowa regulacja koloru za pomocą przełącznika dotykowego	Колір можна регулювати в три кроки за допомогою сенсорного перемикача	culoare reglabilă în trei trepte cu un comutator tactil	Boja se može podesiti u tri koraka pomoću prekidača na dodir	Boja se može podesiti u tri koraka pomoću prekidača na dodir
	czujnik ruchu	датчик руху	senzor de mișcare	senzor kretanja	senzor kretanja
	WŁ/WYŁ Czujnika ruchu	Вкл./ Вкл. датчик руху	Senzor de mișcare ACTIVARE/ DEZACTIVARE	Uključen/isključen senzor pokreta	UKLUČIVANJE/ISKLJUČIVANJE senzora pokreta
	Mikrofalowy czujnik ruchu	Мікрохвильовий датчик	Senzor cu microunde	Mikrotalasni senzor	Mikrovalni senzor
	świeci do góry	світиться вгору	iluminează în sus	svetli prema gore	osvjetljava prema gore
	świeci w dół	напря́м світла донизу	luminează în jos	nadole svetli	svijetli nadolje
	świeci w dół i w górę	напря́м світла донизу і догори	luminează în jos și în sus	svetli i nagore i nadole	svijetli i nadolje i nagore
	z czujnikiem oświetlenia, świeci tylko w ciemności	оснащений сутінковим світловим вмикачем, включається тільки при зниженні інтенсивності освітлення	cu sensor, luminează doar în întuneric	osjetljiv na svetlost, svetli samo u mraku	osjetljiv na svjetlost, svijetli samo u mraku

KEY OF SYMBOLS • JELMAGYARÁZAT • ZEICHENERKLÄRUNG



	Oznake	Символи	Simboliai	Simboli	Sümbolid
	s stikalom	с превключвател	su jungikliu	ar slēdzi	lūlitiga
	Prilagodljiva svetlost s stikalom v 3 korakih	Регулируема яркост с ключ на 3 степени	Ryškusmas reguliuojamas su jungikliu 3 žingsniais	Trīs līmeņu regulējams spilgtums ar slēdzi	Lūlitist 3-astmeliselt reguleeritav heledus
	Prilagodljiva svetlost s stikalom na dotik v 3 korakih	Регулируема яркост с ключ с докосване на 3 степени	Ryškusmas reguliuojamas su jutkliniu jungikliu 3 žingsniais	Trīs līmeņu regulējams spilgtums ar skārienjūtīgu slēdzi	Puutelūlitist 3-astmeliselt reguleeritav heledus
	z stikalom na dotik	със сензорен превключвател	liečiamasis jutiklis	skārienjutīgs slēdzis	puutetundlik lūliti
	Prilagodite svetlost z stikalom na dotik	регулятор на яркостта със сензорен превключвател	liečiamasis pritemdymo jutiklis	skārienjutīgs gaismaiņa slēdzis	puutetundlik valgusregulaator
	možnost nastavitve jakosti svetlobe samo z daljinskim upravljanjem	димирание само чрез дистанционно управление	tik šviesos stiprio kintamasis su nuotolinio valdymo pultu	gaismas intensitāte mainīga tikai ar tālvadības pulti	valguse intensiivsust saab reguleerida ainult kaugjuhtimispuldi abil
	zatemnilnik	с регулятор за силата на светлина	pritemdymo įtaisas	gaismainis	hāvardi
	Svetlost lahko nastavite v petih korakih s stikalom na dotik	Яркостта може да се регулира в пет стъпки със сензорен превключвател	Ryškusmą galima reguliuoti penkiaais žingsniais jutkliniu jungikliu	Spilgtumu var regulēt piecos soļos ar skārienslēdzi	Heledust saab puutelūlitiga viies astmes reguleerida
	Za funkcijo zatemnitve je potrebna uporaba svetlobnega vira, ki ga je mogoče zatemniti	За функцията за димер е необходимо използването на димируем източник на светлина	Pritemdymo funkcijai reikia naudoti pritemdomą šviesos šaltinį	Reostata funkcijai ir nepieciešams izmantot aptumšojams gaismas avots	Hāvardamise funktsiooni jaoks on vaja kasutada hāvardatavat valgusallikat
	LED diode s spremenljivim barvama	LED с променлива светлина	Spalvą keičiantis LED	Maināmas krāsas LED	Vārvi vahetav LED
	Magic RGB	Магическа RGB светлина	Stebuklingas RGB	Maģiskais sarkanazilais krāsu modelis	Magic RGB
	Barvo lahko nastavljate v treh korakih s stikalom na dotik	Цвят, регулируем в три степени със сензорен превключвател	Trijų pakopų spalvų reguliavimas jutkliniu jungikliu	Trīs pakāpu krāsu regulēšana ar skārienslēdzi	Kolmeastmeline vārvuse reguleerimine puutelūlitiga
	senzor gibanja	със сензор за движение	judesio jutiklis	kustības sensors	liikumisandur
	VKLOP/IZKLOP Senzorja gibanja	ВКЛЮЧВАНЕ/ИЗКЛЮЧВАНЕ със сензор за движение	ON / OFF judesio jutiklis	IESLĒGŠANAS/IZSLĒGŠANAS kustību sensors	Liikumisanduriga sisse ja välja lūlitamine
	Mikrovalovni senzor	Микровълнов сензор	Mikrobangų jutiklis	Mikrovļņu sensors	Mikrolaineandur
	sveti navzgor	свети нагоре	šviesa nukreipta į viršų	iedegas uz augšu	valgustab ülespoole
	svetli navzdol	осветява надолу	šviečia žemyn	apgaismo lejup	valgustab allapoole
	svetel in gor in dol	осветява надолу и нагоре	šviečia žemyn ir aukštyn	apgaismo lejup un augšup	valgustab alla- ja ülespoole
	občutljivo na svetlobo, sveti le v temi	реагира на светлина, светва само, когато е тъмно	reaguoja į šviesą, užsidega tik tamsoje	reaģējošs uz gaismu, apgaismo tikai tumsā	valgusreaktiivne, valgustab vaid pimedas

KEY OF SYMBOLS • JELMAGYARÁZAT • ZEICHENERKLÄRUNG



	Symbols	Jelölések	Bezeichnungen	Symboles	Jména
	UV resistant plastic	UV álló műanyag	UV-beständiger Kunststoff	plastique résistant à l'UV	plast odolný UV záření
	lamp operating with solar cells	napelemmel működő lámpa	Leuchte funktioniert über Solarzellen	luminaire fonctionnant avec une cellule photovoltaïque	svítidlo na solární baterii
	IP protection	IP védettség	IP-Klasse	protection IP	IP krytí
	IP protection of built-in lamp	beépített lámpa IP védelme	IP-Schutz der eingebauten Lampe	protection IP de la lampe intégrée	IP krytí zabudovaného svítidla
	Phone App Controllable	Telefonos applikációval vezérelhető	Steuerbar über Telefon-App	Contrôlable via Téléphonique App	Lze ovládat aplikací v telefonu
	fan	ventilátor	Ventilator	ventilateur	ventilátor
	Fan adjustable in 6 steps	6 lépésben állítható ventilátor	Lüfter in 6 Stufen einstellbar	Ventilateur réglable en 6 étapes	Ventilátor nastavitelný v 6 stupních
	ventilator variable with 3 steps	3 lépésben állítható ventilátor	Ventilator in 3 Stufen schaltbar	ventilateur variable à 3 étapes	Ventilátor má 3 úrovně výkonu
	Ventilator with timer function	Ventilátor időzítő funkcióval	Ventilator mit Zeiteinstellung	Ventilateur avec une fonction minuterie	Ventilátor s funkcí časovače
	textile cable	textil kábel	Textilkabel	Câble en tissu	Textilní kabel
	separately switchable light sources	fényforrások külön kapcsolhatóak	Lichtquellen sind extra schaltbar	sources lumineuses changeable séparément	samostatně přepínatelné
	indirect light	indirekt fény	mit indirektem Licht	à lumière indirecte	s nepřímým světlem
	backlight effect	háttérfény funkció	Hintergrundlichteffekt	effet de contre-jour	efekt podsvícení
	mirror	tükör	Spiegel	miroir	zrcadlo
	plastic	műanyag	Plastik (Kunststoff)	plastique	plast
	wood	fa	Holz	bois	dřevo
	plaster	gipsz	Stuck	plâtre	sádra
	Velvet	Bársony	Samt	Velous	Samet
	metal black	metál fekete	metallschwarz	métal noir	kovově černá

KEY OF SYMBOLS • JELMAGYARÁZAT • ZEICHENERKLÄRUNG



	Označenia	Oznaczenia	Позначення	Simboluri	Označavanje
	plast odolný UV žiareníu	tworzywo sztuczne odporne na UV	УФ-стійкий пластик	material plastic rezistent la UV	UV otporna plastika
	plast odolný UV	lampa zasilana energią słoneczną	лампа на сонячній батареї	lampă cu acumulator solar	solarna lampa
	IP ochrana	Stopień ochrony IP	Клас IP-захисту	Protecția IP	IP zaštita
	IP ochrana zabudovanej lampy	wbudowana ochrona IP	IP-захист вбудованої лампи	Protecția IP a lămpii încorporate	IP zaštita ugrađene lampe
	Možno ovládať aplikáciou v telefóne	Możliwość obsługi przez aplikację	Можливість керування за допомогою мобільного додатку	Controlabil prin aplicație mobilă	Kontrola preko telefonske aplikacije
	ventilátor	wentylator	вентилятор	ventilator	ventilator
	Ventilátor nastaviteľný v 6 stupňoch	Wentylator regulowany w 6 stopniach	Вентилятор регулюється на 6 ступенів	Ventilator ajustabil în 6 trepte	Izbor jedne od 6 brzina ventilatora
	3-stupňový nastaviteľný ventilátor	3 poziomy pracy wentylatora	Вентилятор перемикається у 3 кроки	ventilator variabil cu 3 trepte de viteza	Ventilator, podesiv u 3 koraka
	Ventilátor s funkciou časovača	Wentylator z funkcją timera	Вентилятор з функцією таймера	Ventilator cu funcție de temporizare	Ventilator sa tajmerom
	Textilný kábel	Kabel tekstylny	Текстильний кабель	Cablu cu teacă textilă	Tekstilni kabl
	samostatne prepínateľné	Możliwość zastosowania podwójnego wyłącznika	Джерела світла перемикаються окремо	comutabil separat	Odvojeno paljenje
	s nepriamym svetlom	ze światłem pośrednim	з непрямим освітленням	cu lumină indirectă	sa indirektnim svetlom
	efekt podsvietenia	efekt podświetlenia	ефект підсвічування	efect iluminare de fundal	pozadinsko osvetljenje
	Zrkadlo	lustro	дзеркало	oglindă	ogledalo
	plast	wykonane z plastiku	пластик	plastic	plastika
	Drevo	Drewno	дерево	lemn	drven
	sadra	gips	гипс	ghips	gips
	zamat	Aksamit	Оксамит	catifea	tekstil/pliš
	kovovo čierna	metaliczna czerní	металевий чорний	negru metalic	metalik crna

KEY OF SYMBOLS • JELMAGYARÁZAT • ZEICHENERKLÄRUNG



	Oznake	Oznake	Символи	Simboliai	Simboli	Sümbolid
	Plastika otporna na UV zrake	Plastika UV-odporen	устойчива на UV лъчи пластмаса	UV atsparus plastikas	pret UV stariem noturīga plastmasa	UV-kindel plastik
	solarna svjetiljka	sončna svetilka	лампа, работеща със слънчеви батерии	veikia su saulės energijos skydeliu	darbojas ar saules bateriju	sisselūlitamine pāikeselemendīga
	IP zaštita	IP zaščita	с IP защита	IP klasė	IP aizsardzība	IP kaitse
	IP zaštita ugrađena svjetiljke	IP zaščita vgrajene svetilke	IP защита на вградена лампа	IP saugumo lygio įmontuotas šviestuvus	iebūvētās lampas IP aizsardzība	sisse-ehitatud valgusti IP-kaitse
	Telefonska aplikacija kojom je moguće upravljati	Upravljanje s telefonsko aplikacijom	Може да се управлява от приложение за телефон	Telefono programėlė Kontroluojama	To var kontrolēt ar tālruņa lietojumprogrammu	Mobiliļpīga juhitav
	ventilator	ventilator	вентилатор	ventiliatorius	ventilators	ventilaator
	Ventilator prilagodljiv u 6 koraka	Ventilator je nastavljiv v 6 korakih	Вентилаторът се регулира на 6 степени	Ventiliatorius, reguliuojamas 6 veiksmiais	6 soļos regulējams ventilators	6-astmeliselt reguleeritav ventilaator
	Ventilator se može koristiti u 3 brzine	sprememba hitrosti ventilatorja s 3 koraki	Вентилаторът може да се превключва на 3 стъпки	Trijų pakopų ventiliatoriaus sukimosi greičio valdymas	Ventilatora mainīgais ar 3 pakāpieniem	3 tōōkiirusega ventilaator
	Ventilator za podešavanje vremena	Ventilator s funkcijom časovnika	Вентилатор с функция таймер	Ventiliatorius su laikmačio funkcija	Ventilators ar taimera funkciju	Taimerifunktsiooniga ventilaator
	Tekstilni kabel	Tekstilni kabel	Текстилен кабел	Tekstile vilktas laidas	Vads ar tekstilmateriālu pārklājumu	Tekstiilkaabel
	Izvori svjetlosti se mogu uključiti odvojeno	ločen preklop virov svetlobe	Отделно превключване	Atskirai perjungiamas	Atsevišķi pārslēdzams	eraldi lūlitatavad valgusallikad
	s neizravnim svjetlom	s posredno svetlobo	с индиректна светлина	su netiesiogine šviesa	ar netiešu gaismu	kaudvalgusega
	efekt pozadinskog svjetla	učinek osvetlitve	ефект на подсветка	foninio apšvietimo efektas	aizmugurapgaismojuma efekts	tagantvalgustuse efekt
	Zrcalo	zrcalo	огледало	dubliuojamasis tomas	spogulis	peegel
	plastika	plastika	пластмаса	plastikinis	plastmasa	plastist
	drvo	les	дърво	medis	koksne	puit
	žbuka	mavec	гипс	gipsas	ģipsis	kipskrohvisegu
	Baršun	Velvet	Кадифе	Velvetas	Samta	Velvet
	metalno crno	kovinsko črna	метално черно	metalinis juodas	metāliski melns	metalne must

KEY OF SYMBOLS • JELMAGYARÁZAT • ZEICHENERKLÄRUNG



GBR



HUN



GER



FRA



CZE



SVK

	Symbols	Jelölések	Bezeichnungen	Symboles	Jména	Označenia
	shiny	fényes	glänzend	brillant	lesklé	lesklé
	soft touch	puha szilikon	sanfte Berührung	toucher doux	jemný dotyk	jemný dotyk
	rope	kötél	Seil	corde	lano	lano
	starlight effect	csilló effekt	Glitzereffekt	effet scintillant	efekt jiskření	efekt iskrenia
	flashing effect	villogó effekt	Blinkeffekt	effet clignotant	efekt blikání	efekt blikania
	timer function	időzítő funkció	mit einer Zeitfunktion	avec fonction de temps	s časovačem	s časovačom
	night light function	éjszakai funkció	Nachtfunktion	fonction nuit	funkce nočního světla	funkcia nočného svetla
	memory function	memória funkció	Speicherfunktion	fonction mémoire	funkce pamět	funkcia pamäte
	alarm clock function	ébresztőóra funkció	Wecker-Funktion	fonction réveil	funkce budíku	funkcia budíka
	built-in speaker	beépített hangszóró	integrierter Lautsprecher	haut-parleur intégré	zabudovaný reproduktor	zabudovaný reproduktor
	Without pendant set	Függeszték szett nélkül	Ohne Hängeleuchte-Set	Ensemble sans pendentif	Bez závěsného setu	Bez závesného setu
	adjustable height shank	állítható magasság	höhenverstellbarer Schaft	avec tige de taille réglable	rameno s nastaviteľnou výškou	rameno s nastaviteľnou výškou
	slimline	keskeny kivitel	schmale Variante	version étroite	tenké provedení	úzke prevedenie
	works on the principle of magnetic induction	mágneses indukció elvén működik	Funktioniert nach dem Prinzip der magnetischen Induktion	Cela fonctionne sur le principe de l'induction magnétique	Funguje na princípu magnetické indukce	Funguje na princípe magnetickej indukcie
	can be controlled via Bluetooth	vezérlés Bluetooth kapcsolaton keresztül	Steuerung über Bluetooth	commande via liaison Bluetooth	ovládání prostřednictvím Bluetooth kontaktu	riadenie prostredníctvom Bluetooth pripojenia
	wireless charger	vezeték nélküli töltő	kabelloses Ladegerät	chargeur sans fil	bezdrátová nabíječka	bezdrátová nabíjačka
	USB input	USB bemenet	USB-Eingang	Port USB	USB vstup	USB vstup
	with USB cable and adaptor	USB vezetékkel és adapterrel	mit USB Kabeln und Adapter	avec câble USB et adaptateur	USB kabel a adaptér	s USB káblom a adaptérom
	micro-USB included	micro-USB tartozék	Micro-USB Zubehör	Avec Micro USB livré	Micro-USB v příslušenství	Príslušenstvo Micro-USB

KEY OF SYMBOLS • JELMAGYARÁZAT • ZEICHENERKLÄRUNG



	Oznaczenia	Позначення	Simboluri	Označavanje	Oznake
	lśniący	яскравий	lucios	sjajno	sjajno
	miękki w dotyku	м'який дотик	atingere ușoară	mek dodir	lagani dodir
	lina	мотузка	frânghie	конопац	uže
	efekt iskrzenia	мерехтливий ефект	efect strălucitor	efekt svetlucanja	efekt svjetlucanja
	Efekt migania	миготливий ефект	efect intermitent	efekat treperenja	efekt bljeskanja
	z funkcją timera	з функцією таймера	cu temporizator	sa vremenskom funkcijom	s vremenskom funkcijom
	Funkcja światła nocnego	функція нічника	Funcție lumina de noapte	funkcija nočno svetlo	funkcija noćnog svjetla
	Funkcja pamięci	функція пам'яті	Funcție de memorie	funkcija pamćenja	funkcija memorije
	funkcja budzika	функція будильника	funcție ceas deșteptător	funkcija budilice	funkcija budilice
	wbudowany głośnik	вмонтований гучномовець	Difuzor încorporat	ugrađen zvučnik	ugrađen zvučnik
	Bez zawieszenia	Без підвісного набору	Fără set pandantiv	Bez instaliranog visećeg dela	Set bez privjeska
	ga (podstawa) z możliwością ustawienia wysokości	можливість регулювання по висоті	suport cu înălțime reglabilă	podesiva visina stabla	podesivi krak
	wąska konstrukcja	вузький дизайн	Design îngust	uska izvedba	uska izvedba
	działa na zasadzie indukcji magnetycznej	Він працює за принципом магнітної індукції	Funcționează pe principiul inducției magnetice	radi na principu magnetne indukcije	Radi na principu magnetne indukcije
	sterowanie przez połączenie Bluetooth	керування через Bluetooth	operare prin conexiune Bluetooth	upravljanje preko Bluetooth veze	upravljanje putem Bluetootha
	ładowarka bezprzewodowa	бездротовий зарядний пристрій	incărcător wireless	bežični punjač	bežični punjač
	port USB	вхід USB	Intrare USB	USB ulaz	USB utor
	z kablem USB i adapterem	із USB-кабелем та адаптером	Cablu USB și adaptor	sa USB priključkom i adapterom	s USB priključkom i adapterom
	Micro-USB w zestawie	Містить мікро-USB	Accesoriu Micro-USB	Mikro-USB dodatna oprema	Mikro USB pribor

KEY OF SYMBOLS • JELMAGYARÁZAT • ZEICHENERKLÄRUNG



	Oznake	Символи	Simboliai	Simboli	Sümbolid
	sijoče	лъскаво	blizgantis	spīdīgs	läikiv
	mehko na dotik	меко докосване	Švelnus palietimas	maiga pieskāriena	pehme puudutus
	vrv	въже	virvė	virve	kõis
	učinek bleščanja	искрящ ефект	žvilgesio efektas	spīguļojošs efekts	sādeleva efektīga
	utripajoči učinek	мигащ ефект	blyksėjimo efektas	mirgošanas efekts	vālguefekt
	s časovno funkcijo	с функция за време	su laiko funkcija	ar laika funkciju	ajafunktsiooniga
	nočna funkcija	функция нощна светлина	naktinio apšvietimo funkcija	nakts apgaismojuma funkcija	öine funktsioon
	pomnilna funkcija	функция памет	atminties funkcija	atmiņas funkcija	mālu funktsioon
	funkcija budilke	функция на будилника	žadintuvo funkcija	modinātāja funkcija	äratuskella funktsioon
	vgrajen zvočnik	вграден високоговорител	įmontuotas garsiakalbis	iebūvēts skaļrunis	sisseehitatud kõlar
	Brez seta za obešanje	Без комплект за полилей	Be pakabukų rinkinio	Bez piekaramā gaismekļa komplekta	Ilma riputuskomplektilta
	nastavljiv nosilec	стълб с променлива височина	reguliuojamo aukščio strypas	regulējams turētāja augstums	reguleeritava kõrgusega kinnitustang
	ozka izvedba	тясно изпълнение	mažų matmenų	plāns	õhuke profiil
	Deluje na principu magnetne indukcije	Работи на принципа на магнитната индукция	Veikia magnetinės indukcijos principu	Darbojas pēc magnētiskās indukcijas principa	Toimib magnetinduktsiooni põhimõttel
	nadzor prek povezave Bluetooth	управление чрез Bluetooth връзка	Galima valdyti naudojant Bluetooth	Var kontrolēt, izmantojot Bluetooth	Juhitav Bluetooth kaudu
	brežžični polnilec	безжично зарядно устройство	belaidis įkroviklis	bezvadu lādētājs	juhtmeta laadija
	USB vhod	USB вход	USB įvestis	USB ieeja	USB-sisend
	z USB priključkom in adapterjem	с USB кабел и адаптер	su USB kabeliu ir adapteriu	ar USB kabeli un adapteri	USB-kaabli ja adapteriga
	Mikro USB-pripomoček	С принадлежност Micro-USB	Pridedama „Micro-USB“	Micro-USB iekļauts komplektā	Mikro-USB komplektis

KEY OF SYMBOLS • JELMAGYARÁZAT • ZEICHENERKLÄRUNG



	Symbols	Jelölések	Bezeichnungen	Symboles	Jména
	can be used as a loudspeaker for smartphone, tablet or computer with the jack cable (included).	Hozzáadott Jack kábellel Okostelefonhoz, táblagéphez, vagy számítógéphez hangfalként használható.	Mit beigelegtem Klinkenkabel auch als Lautsprecher für Smartphones, Tablets oder Computer verwendbar	Peut être utilisé comme haut parleur d'un smartphone, d'une tablette ou d'un ordinateur avec le câble jack livré	Funkce reproduktoru prostřednictvím Jack kabelu zapojeného do chytrého telefonu, tabletu nebo počítače
	battery excluded	elemet nem tartalmaz	ohne Batterie	pile non incluse	baterie není součástí balení
	battery included	elemet tartalmaz	inklusive Batterie	pile incluse	součástí balení je baterie
	IK08 strong diffusor	búra mechanikus ütődés elleni védelem 08	Schlagfestigkeit IK08	Diffuseur puissant IK08	Odolnost proti nárazu IK08
	socket light version	konnektorba dugható kivitel	Steckdosenleuchten-Version	Design plug-in	verze světla do zásuvky
	Equipped with SCHUKO Type F, CEE 7/4 power connector socket. Not available for CZ, SK and PL.	SCHUKO Type F, CEE 7/4 hálózati csatlakozó aljzattal. Nem rendelhető: CZ, SK és PL.	Mit SCHUKO Netzstecker Typ F, CEE 7/4. Nicht bestellbar in: CZ, SK und PL	SCHUKO Type F, avec douille CEE 7/4. Ne peut être commandé : CZ, SK et PL	SCHUKO Type F, CEE 7/4 se síťovou zásuvkou. Nelze objednat: CZ, SK a PL
	can be combined with max. fixtures	max. ... darabig sorolható	Max. ... Stück in Reihenschaltung verwendbar	alignement jusqu'à ... pièces au maximum	sériové zapojení do max. ... ks
	hand painted	kézzel festett	handbemalt	peint à la main	ručně malované
	paintable	festhető	bemalbar	peut être peint(e)	možnost nabarvení
	not suitable for cutting	nem vágható	nicht zerschneidbar	ne peut pas être coupé	nelze stříhat
	Number of LED diodes per metre	LED diódák száma méterenként	Anzahl der LED-Dioden pro Meter	Nombre de diodes DEL par mètre	Počet LED diod na metr
	with house number sticker	hátszám matricával	mit Hausnummersticker	avec sticker numéro de la maison	číslo popisné s nálepkou
	2 in 1	kettő az egyben	2 in 1	2 en 1	2 v 1
	units/set	darab/szett	Stück/Set	pièce / lot	ks/sada
	delivery unit	szállítási egység	Liefereinheit	unité de transport	dodací jednotka
	Cannot be ordered and cannot be delivered to Russia and the Ukraine.	Nem rendelhető és nem szállítható Oroszországba és Ukrajnába.	Nicht bestellbar und lieferbar in Russland und der Ukraine	Ne peut pas être commandé et n'est pas livré en Russie et en Ukraine	Nelze objednat ani dodat do Ruska a na Ukrajinu
	Cannot be ordered and cannot be delivered to Slovakia, Czech Republic, Poland.	Nem rendelhető és nem szállítható Szlovákiába, Csehországba, Lengyelországba.	Kann in der Slowakei, der Tschechischen Republik und in Polen nicht bestellt und nicht geliefert werden	Ne peut pas être commandé et ne peut pas être livré en Slovaquie, en République tchèque ni en Pologne	Není možné objednat a nemůže být doručeno na Slovensko, do České republiky, Polska
	environmentally friendly	környezetbarát	umweltschonend	écologique	je šetrný k životnímu prostředí

KEY OF SYMBOLS • JELMAGYARÁZAT • ZEICHENERKLÄRUNG



	Označenia	Oznaczenia	Позначення	Simboluri	Označavanje
	Možnosť použitia ako reproduktor ku chytrému telefónu, tabletu alebo k počítaču s priloženým Jack káblom	Przy pomocy kabla Jack może być używany jako głośnik do smartfona, tabletu czy komputera	Завдяки доданому кабелю зі штекером можна використовувати до Смартфона, планшета або ПК як гучномовець	Poate fi utilizat ca difuzor cu conexiune cablu Jack la smartphone, tabletă sau calculator	Sa priloženom Jack kablom kao zvučnik može da se priključi pametnom telefonu, tabletu ili računaru
	batéria nie je súčasťou balenia	Nie zawiera baterii	батарея не додається	bateria nu e inclusă	bez baterije
	súčasťou balenia je batéria	Bateria w zestawie	батарея додається	bateria este inclusă	baterija u opremi
	silný difúzor IK08	Ochrona przed uderzeniami mechanicznymi IK08	Захист від механічного пошкодження плафону IK08	Difuzor puternic IK08	IK08 čvrst difuzor
	verzia svetla do zásuvky	wersja z gniazdem	модель світлового гнізда	versiune cu fasung	verzija sa grlom za lampu
	SCHUKO Type F, CEE 7/4 so sieťovou zásuvkou. Nie je možné objednať: CZ, SK a PL	Z gniazdem zasilania SCHUKO Type F, CEE 7/4. Brak możliwości zamawiania: CZ, SK i PL	SCHUKO Type F, з гніздом живлення CEE 7/4. Неможливо замовляти: CZ, SK та PL	Cu soclu priză SCHUKO Type F, CEE 7/4. Nu poate fi comandat în CZ, SK și PL	Sa mrežnom priključnicom tipa SCHUKO Type F, CEE 7/4 Ne može da se naruči iz: CZ, SK i PL
	možnosť zapojenia do radu do max ... ks	podłączenie szeregowo maks. ... szt	можливо послідовно з'єднати макс. до ... шт.	serie de maxim ... bucăți	maksimalno do . kom. može dase priključi redno
	ručne maľované	ręcznie malowane	фарбований вручну	vopsit manual	ručno farbana
	možnosť maľovania	przystosowana do malowania	можна фарбувати	Poate fi vopsit	može da se farba
	nemožno strihať	cięcie nie jest możliwe	не можна різати	nu poate fi tăiat	ne može se seći
	Počet LED diód na meter	Liczba diod LED na metr	Кількість світлодіодів на метр	Nr. de LED-uri pe metru	Broj LED dioda po metru
	s nálepkou čísla domu	z naklejką numeru domu	із наклейкою номера будинку	număr de casă cu sticker	sa matricom kućnog broja
	2 v 1	2 w 1	2 в 1	2 în 1	2 u 1
	kus/sada	sztuka/zestaw	шт / комплект	bucăți/set	komad/set
	dodacia jednotka	jednostka logistyczna	одиниця поставки	unitate de livrare	transportna jedinica
	Nie je možné objednať a nedodáva sa do Ruska a Ukrajiny	Brak możliwości zamawiania i dostawy do Rosji i na Ukrainę	Можливість замовлення і доставки до Росії та України відсутня	Nu poate fi comandat din și livrat în Rusia și Ucraina	Ne može da se naruči i da se isporuču u Rusiju i u Ukrajinu
	Nie je možné objednať a nemôže byť doručené na Slovensko, do Českej republiky, Poľska	Niedostępne dla zamówienia i dostawy na Słowację, do Czech i Polski	Неможливо замовити та доставити до Словаччини, Чехії, Польщі	Nu poate fi comandat din și nici livrat în Slovacia, Republica Cehă, Polonia	Ne može da se naruči i ne može da se isporuču u Slovačku, Češku Republiku i Poljsku
	šetrný k životnému prostrediu	Przyjazny dla środowiska	безпечний для довкілля	ecologic	ekološki prihvatljiv

KEY OF SYMBOLS • JELMAGYARÁZAT • ZEICHENERKLÄRUNG



	Oznake	Oznake	Символи	Simboliai	Simboli	Sümbolid
	S isporučenim Jack kabeļom, može se povezati s pametnim telefonom, tabletom ili računalom kao zvučnik	S priloženim Jack kablom se lahko kot zvočnik poveže s pametnim telefonom, tabličnim računalnikom ali računalnikom	С принадлежащия Jack кабел може да се ползва като тонколона към смартфон, таблет или компютър	Galima naudoti kaip išmaniojo telefono, planšetinio kompiuterio arba įprasto kompiuterio garso kolonėlę, prijungus lizdo kabelį (pridedamas)	Var lietot kā skaļruni viedtālrunim, planšētdatoram vai datoram ar līgzdas kabeli (iekļauts komplektā)	Helipistikuga (komplektis) kasutatav nutitelefoni, tahvelarvuti või arvuti kõlarina
	baterija nije uključena	baterije niso uključene	не е предоставена батерия	be baterijos	baterija neietilpst komplektā	patarei ei kuulu komplekti
	baterija je uključena	baterije so uključene	предоставена батерия	su baterija	baterija ietilpst komplektā	patarei kuulub komplekti
	zaštita od mehaničkih utjecaja	IK08 močan difuzor	Устойчивост на удар IK08	Tvirtumo klasė IK08	IK08 spēcīgs difuzors	IK08 lōögikindluse klassi hajuti
	verzija s grom za svjetiljku	različica z okovom žarnice	тип на цокъла	kontaktligzdā iespraužamu gaismekļu versija	lizdo lempas versija	lambipesaga versioon
	S mrežnim priključkom tipa SCHUKO Type F, CEE 7/4 Nije moguće naručiti iz: CZ, SK i PL	Z vtičem tipa SCHUKO Type F, CEE 7/4 Ni mogoče naročiti pri: CZ, SK in PL	SCHUKO Type F, захранващо щепселно гнездо CEE 7/4. Не може да се заявява за: CZ, SK и PL	Įmontuotas SCHUKO F tipo CEE 7/4 maitinimo įvesties lizdas. Neprieinama CZ, SK ir PL	Aprīkots ar SCHUKO F tipa, CEE 7/4 strāvas ievades/izvades līgzdu. Nav pieejams CZ, SK un PL	SCHUKO Tüüp F, CEE 7/4 toite sisse/välja pistikuga. Mitte saadaval CZ, SK ja PL jaoks
	maksimalno do ... kom. mogu se redovito povezivati	največ do ... kos. se lahko redno poveže	може да ползва макс. ... бр.	galima prijungti maks. ... tvirtinimo elementus	var apvienot ar maks. ... gaismekļiem	kombineeritav kuni ... valgustiga
	ručno farbana	ručno barvana	оцветен на ръка	ranka dažytas	apgleznots ar rokām	kāsitsi värvitud
	može da se farba	lahko naslikamo	оцветим	galima nudažyti	var krāsot	värvitav
	ne može se rezati	ni mogoče rezati	не може да се реже	netinka pjaustymui	nav piemērots griešanai	ei sobi lõikamiseks
	Broj LED dioda po metru	Število LED dioda na meter	Брой светодиоди на метър	Šviesos diodų skaičius viename metre	Diožu skaits uz metru	Valgusdiodeide arv meetri kohta
	s matricom kućnog broja	z matrico hišnega številka	със стикер дом№	su namo numerio lipduku	ar ēkas numura uzlīmi	koos majanumbri kleepsuga
	2 u 1	2 v 1	2 в 1	Du viename	Divi vienā	Kaks-ühes
	komad / set	kos / set	брой/сет	vnt./rinkinys	gab./komplektā	tükki/komplekt
	transportna jedinica	transportna enota	транспортна единица	pristatomas įrenginys	piegādes vienība	tarnesse kuulub
	Ne može se naručiti i isporučiti u Rusiju i u Ukrajinu	Ni ga mogoče naročiti in dostaviti v Rusijo in Ukrajinu	Не може да се заявява и не се доставя в Русия и Украйна	Negalima užsakyti ir negalima pristatyti į Rusiją ir į Ukrainą	Nevar pasūtīt un piegādāt uz Krieviju un Ukrainu	Venemaale ja Ukrainasse ei saa tellida ega saata
	Ne može se naručiti niti isporučiti u Slovačku, Republiku Češku i Poljsku	Ni mogoče naročiti in ne more biti dostavljeno na Slovaško, Češko in Poljsko	Не може да бъде поръчано и не може да бъде доставено до Словакия, Чехия, Полша	Negalima užsakyti ir pristatyti į Slovakiją, Čekiją, Lenkiją	Nevar pasūtīt un piegādāt uz Slovākiju, Čehiju un Poliju	Ei saa tellida ja tarnida Slovakkiasse, Tšehhi Vabariiki ja Poolasse
	ekološki prihvatljiv	okolju prijazno	щадящ околната среда	draugiškas aplinkai	videi draudzīgs	keskkonnasõbralik

CONTENTS • TARTALOMJEGYZÉK • INHALTSVERZEICHNIS

New	Art. number	Name	Page
Új	Cikkszám	Név	Oldal
Neu	Art. nummer	Name	Seite

New	Art. number	Name	Page
Új	Cikkszám	Név	Oldal
Neu	Art. nummer	Name	Seite

New	Art. number	Name	Page
Új	Cikkszám	Név	Oldal
Neu	Art. nummer	Name	Seite

New	Art. number	Name	Page
Új	Cikkszám	Név	Oldal
Neu	Art. nummer	Name	Seite

	1046	Lite	522
	1047	Lite	522
	1048	Lite	522
	1049	Lite	523
	1050	Lite	523
	1051	Lite	523
	1072	Randy	521
	1078	Randy	521
	1079	Randy	521
	1080	Randy	521
	1087	Spot Relight	524
	1088	Spot Relight	524
	1089	Spot Relight	524
	1090	Spot Relight	524
	1091	Spot Relight	525
	1092	Spot Relight	525
	1093	Spot Relight	525
	1095	Spot Relight	525
	1120	Spot Fashion	521
	1147	Spot Fashion	521
	1163	Lite	522
	1166	Lite	523
	1301	Bottom	385
	1302	Togo	473
	1331	Fix	383
	1332	Fix	383
	1338	Fix	383
	1408	Cupola Range	369
	1411	Fixy	382
	1412	Roxy	382
	1417	Fixy	382
	1418	Fixy	382
	1421	Rolly Pull	385
	1426	Primrose	314
	1427	Primrose	314
	1428	Nolan	318
	1431	Marlon	85
	1433	Marlon	85
	1448	Albina	484
	1449	Albina	484
	1450	Batten Light	496
	1451	Batten Light	496
	1452	Batten Light	496
	1453	Batten Light	496
	1454	Drop Light	619
	1455	Drop Light	619
	1464	Albina	484
	1470	Lina	444
	1477	Noah	433
	1478	Noah	433
	1479	Noah	433
	1480	Noah	433
	1481	Noah	433
	1482	Noah	433
	1489	Sonnet	513
	1490	Sonnet	513
	1491	Sonnet	352
	1492	Sonnet	352
	1496	Ludovic	489
	1498	Ludovic	489

	1507	Mason	324
	1508	Mason	324
	1509	Mason	324
	1510	Leonie	317
	1515	Justin	421
	1518	Coralia	315
	1519	Coralia	315
	1803	Simple	370
	1817	Soley	370
	1818	Soley	370
	1819	Soley	370
	1822	Spiral	370
	1843	Ada	368
	1844	Ada	368
	1845	Scroll	368
	1846	Scroll	368
	1847	Bloomy	368
	1848	Bloomy	368
	1861	Jolly	364
	1862	Jolly	364
	1864	Jolly	364
	1940	Art Gold	359
	1941	Art Gold	359
	1942	Art Gold	359
	1960	Jolly	364
	2012	Lagertha	326
NEW	2029	Nilfgard	418
	2047	Kobald	510
	2048	Kobald	510
	2049	Kobald	510
	2050	Kobald	510
	2051	Kobald	511
	2052	Kobald	511
	2053	Kobald	511
	2054	Kobald	511
	2055	Kobald	511
	2056	Kobald	511
	2065	Matt	483
	2066	Matt	483
	2068	Lychee	403
	2069	Lychee	403
NEW	2081	Solo	240
NEW	2082	Solo	240
NEW	2083	Solo	240
NEW	2084	Solo	241
NEW	2085	Solo	241
NEW	2086	Solo	241
NEW	2090	Bruno	414
	2102	Lanny	58
	2103	Lanny	58
	2104	Lanny	58
	2110	Becca	466
	2111	Becca	466
	2112	Becca	466
	2113	Becca	466
	2114	Levon	484
	2115	Levon	484
	2116	Lanny	58
	2117	Bruce	318
	2118	Bruce	318

	2119	Sedona	298
	2130	Lupita	290
	2131	Lupita	290
NEW	2145	Ariel	409
NEW	2146	Ariel	409
NEW	2150	Spot Relight	524
NEW	2151	Spot Relight	524
	2156	Alessandra	221
	2157	Alessandra	221
	2158	Alessandra	221
	2161	Alessandra	220
	2162	Alessandra	220
	2163	Alessandra	220
	2166	Evan	461
	2167	Evan	461
	2168	Evan	461
	2173	Damek	344
	2174	Damek	344
	2175	Damek	344
	2183	Selena	312
	2184	Selena	312
	2187	Aniela	127
	2188	Aniela	127
	2191	Taleb	345
	2192	Taleb	345
	2193	Taleb	345
	2194	Niagara	468
	2195	Niagara	468
NEW	2196	Aristeo	394
NEW	2197	Aristeo	394
	2224	Caspar	54
	2229	Avalon	129
	2230	Avalon	129
	2236	Pallas	172
	2237	Pallas	172
	2238	Pallas	172
	2239	Pallas	172
	2240	Flint	391
	2241	Flint	391
NEW	2242	Flint	391
NEW	2243	Flint	391
NEW	2249	Triton	320/1
	2269	Joel	198
	2270	Joel	198
	2271	Joel	198
	2276	Manorca	76
	2277	Manorca	76
	2278	Kaia	74
	2279	Kaia	74
NEW	2280	Heimdall	320/6
NEW	2281	Heimdall	320/6
NEW	2282	Pumpkin	446
NEW	2283	Pumpkin	446
	2284	Rob	340
	2285	Rob	340
	2286	Rob	341
	2287	Rob	341
NEW	2289	Indigo	46
NEW	2290	Rasmus	320/2
NEW	2291	Rasmus	320/2

NEW	2292	Indigo	46
NEW	2293	Indigo	46
NEW	2294	Indigo	47
NEW	2295	Lydia	415
NEW	2296	Lydia	415
	2301	Band Light	500
	2302	Band Light	500
	2303	Band Light	500
	2304	Band Light	500
	2305	Band Light	500
	2306	Band Light	501
	2307	Band Light	501
	2308	Band Light	501
	2309	Band Light	501
NEW	2310	Draco	389
	2321	Bath	494
	2322	Bath	494
	2323	Bath	494
	2326	Soft	495
	2327	Soft	495
	2328	Soft	495
	2329	Soft	495
	2341	Slim	492
	2342	Slim	492
	2343	Slim	492
	2344	Slim	492
	2345	Slim	492
	2361	Easy Light	491
	2362	Easy Light	491
	2363	Easy Light	491
	2364	Easy Light	491
	2365	Easy Light	491
	2366	Easy Light	491
	2420	Cressida	313
	2427	Tamino	349
	2428	Adrienne	126
	2429	Adrienne	126
	2431	Grace	373
	2432	Grace	373
	2448	Danielle	177
	2449	Danielle	177
	2451	Marcella	177
	2478	Meredith	114
	2479	Meredith	114
	2480	Meredith	114
	2481	Meredith	114
	2484	Donald	512
	2485	Donald	512
	2486	Maddox	512
	2487	Maddox	512
	2503	Alexis	308
	2504	Alexis	308
	2543	Donatella	125
	2544	Donatella	125
	2545	Donatella	125
	2546	Donatella	125
	2558	Holden	358
	2563	Sadie	83
	2577	Derek	69
	2578	Derek	69

CONTENTS • TARTALOMJEGYZÉK • INHALTSVERZEICHNIS

New	Art. number	Name	Page
Új	Cikkszám	Név	Oldal
Neu	Art. nummer	Name	Seite

New	Art. number	Name	Page
Új	Cikkszám	Név	Oldal
Neu	Art. nummer	Name	Seite

New	Art. number	Name	Page
Új	Cikkszám	Név	Oldal
Neu	Art. nummer	Name	Seite

New	Art. number	Name	Page
Új	Cikkszám	Név	Oldal
Neu	Art. nummer	Name	Seite

	2579	Derek	69
	2598	Amy	261
	2604	Hecate	299
	2615	Corinna	174
	2616	Corinna	174
	2617	Corinna	174
	2618	Corinna	174
	2619	Emily	204
	2620	Emily	204
	2621	Melissa	180
	2622	Melissa	180
	2623	Briella	169
	2624	Briella	169
	2628	Anastasia	110
	2629	Anastasia	111
	2630	Anastasia	111
	2631	Anastasia	110
	2632	Anastasia	111
	2633	Anastasia	111
	2634	Anastasia	110
	2655	Lois	519
	2656	Lois	519
	2657	Lois	519
	2658	Lois	519
	2663	Lois	518
	2664	Lois	518
	2665	Lois	518
	2666	Lois	518
NEW	2671	Prudence	154
NEW	2672	Prudence	154
	2676	Flores	455
	2677	Hekla	457
NEW	2678	Shaun	504
NEW	2679	Shaun	504
NEW	2680	Shaun	504
NEW	2681	Shaun	504
NEW	2682	Shaun	505
NEW	2683	Shaun	505
NEW	2684	Shaun	505
NEW	2685	Shaun	505
NEW	2686	Shaun	508
NEW	2687	Shaun	508
NEW	2688	Shaun	508
NEW	2689	Shaun	508
NEW	2690	Shaun	508
NEW	2691	Shaun	508
NEW	2692	Shaun	478
NEW	2693	Shaun	478
	2694	Nalani	410
	2695	Nalani	410
	2696	Nalani	410
	2697	Zenon	617
	2698	Zenon	617
	2699	Zenon	617
	2700	Zenon	617
	2701	Marian	190
	2702	Marian	190
	2703	Marian	190
	2705	Marian	191
	2706	Marian	190

	2707	Marian	190
	2708	Marian	191
	2723	Aksel	64
	2724	Aksel	64
	2751	Elisett	195
	2752	Elisett	195
	2753	Elisett	194
	2755	Elisett	194
	2756	Elisett	194
	2757	Elisett	194
	2758	Elisett	194
	2759	Elisett	195
	2763	Oscar	336
	2764	Oscar	336
	2774	Blanka	404
	2775	Blanka	404
	2778	Aletta	189
	2779	Aletta	189
	2780	Aletta	189
	2783	Oscar	337
	2784	Oscar	337
	2804	Holden	358
	2839	Lilian	205
	2849	Lilian	205
	2910	Doug	65
	2930	Kyle	65
NEW	2932	Herkules	320/4
NEW	2934	Horus	412
NEW	2937	Stregobor	320/4
NEW	2957	Eucalyptus	116
	2968	Danila	181
	2969	Danila	181
	2970	Danila	181
	2977	Tekla	430
	2982	Wolimir	474
	2987	Mokka	329
	3000	Matea	328
	3001	Alabastro	362
	3002	Alabastro	362
	3003	Alabastro	363
	3008	Trevor	321
	3009	Trevor	321
	3010	Trevor	321
NEW	3014	Nayara	320/7
	3015	Calvin	317
	3016	Kinga	404
	3017	Kinga	404
	3018	Callia	23
	3019	Callia	23
	3020	Callia	23
	3050	Alfons	378
	3053	Alabastro	361
	3054	Slava	478
	3059	Calista	80
	3060	Calista	80
	3064	Ziva	313
	3072	Lucas	338
	3073	Lucas	338
	3074	Lucas	338
	3075	Benita	335

	3076	Benita	335
	3077	Benita	335
	3078	Benita	335
	3079	Hanka	438
	3080	Hanka	438
	3081	Cardamom	146
	3082	Ceilo	102
	3083	Ceilo	102
NEW	3084	Quince	320/6
	3086	Eldrick	325
	3087	Eldrick	325
	3088	Monty	417
	3089	Monty	417
	3090	Cinnamon	84
	3091	Cinnamon	84
	3092	Flint	391
	3093	Flint	391
	3094	Malia	68
	3095	Malia	68
	3096	Malia	68
	3097	Taneli	292
	3098	Taneli	292
	3099	Taneli	293
	3100	Taneli	293
	3113	Duchess	170
	3114	Duchess	170
	3115	Duchess	171
	3116	Duchess	171
	3117	Duchess	171
	3118	Cardamom	146
	3119	Cardamom	146
	3120	Cardamom	146
	3123	Dimitri	26
	3124	Dimitri	26
	3125	Dimitri	27
	3126	Dimitri	27
	3127	Grendel	30
	3128	Grendel	30
	3129	Grendel	30
	3130	Grendel	30
	3131	Grendel	31
	3132	Grendel	31
	3133	Rattan	44
	3134	Rattan	44
	3135	Rattan	44
	3136	Rattan	44
	3137	Zeus	246
	3138	Zeus	246
	3139	Zeus	246
	3140	Zeus	246
NEW	3143	Tatjana	320/7
NEW	3144	Tatjana	320/7
NEW	3145	Tatjana	320/7
NEW	3146	Achilles	320/1
NEW	3147	Farfalle	37
NEW	3148	Farfalle	37
NEW	3149	Farfalle	37
NEW	3150	Farfalle	37
	3153	Zelkova	156
	3154	Zelkova	156

	3155	Zelkova	156
	3156	Zelkova	157
	3157	Alvaro	60
	3158	Alvaro	60
	3159	Alvaro	61
	3160	Alvaro	61
	3163	Shaun	506
	3164	Shaun	506
	3165	Shaun	506
	3166	Shaun	506
	3167	Shaun	507
	3168	Shaun	507
	3169	Shaun	507
	3170	Shaun	507
	3171	Shaun	509
	3172	Shaun	509
	3173	Shaun	509
	3174	Shaun	509
	3175	Shaun	509
	3176	Shaun	509
	3177	Monet	139
	3178	Monet	139
	3179	Boogie	414
	3180	Boogie	414
	3181	Fanny	416
	3182	Fanny	416
	3183	Blake	248
	3184	Blake	248
	3185	Blake	248
	3186	Blake	248
NEW	3189	Ursula	152
NEW	3190	Ursula	152
NEW	3200	Sigurd	320/8
	3201	Alabastro	362
	3202	Alabastro	362
	3203	Alabastro	363
	3207	Antoine	469
	3208	Antoine	469
	3209	Antoine	469
	3210	Antoine	469
	3214	Fidel	56
	3215	Fidel	56
	3216	Fidel	56
	3217	Fidel	56
	3218	Fidel	57
	3219	Rufin	414
	3220	Rufin	414
	3239	Ophus	395
	3240	Ophus	395
	3244	Miguel	107
	3245	Miguel	107
	3246	Miguel	107
	3247	Miguel	107
	3248	Tarien	224
	3249	Tarien	224
	3250	Tarien	224
	3253	Alabastro	361
	3254	Tornado	290
	3256	Meridia	132
	3257	Meridia	132

CONTENTS • TARTALOMJEGYZÉK • INHALTSVERZEICHNIS

New	Art. number	Name	Page
Új	Cikkszám	Név	Oldal
Neu	Art. nummer	Name	Seite

New	Art. number	Name	Page
Új	Cikkszám	Név	Oldal
Neu	Art. nummer	Name	Seite

New	Art. number	Name	Page
Új	Cikkszám	Név	Oldal
Neu	Art. nummer	Name	Seite

New	Art. number	Name	Page
Új	Cikkszám	Név	Oldal
Neu	Art. nummer	Name	Seite

	3260	Octav	326
	3264	Taneli	292
	3278	Pavel	347
	3283	Foster	352
	3295	Sullivan	140
	3296	Sullivan	140
	3297	Sullivan	140
	3298	Rotem	63
	3299	Rotem	63
	3300	Rotem	63
	3301	Alabastro	362
	3302	Alabastro	362
	3303	Alabastro	363
	3307	Otilia	105
	3308	Otilia	105
	3309	Yago	471
	3310	Yago	471
	3314	Tesia	94
	3315	Tesia	94
	3316	Tesia	95
	3317	Tesia	95
	3318	Portia	297
	3319	Portia	297
	3320	Zenith	300
	3328	Tayla	316
	3331	Vesta	301
	3335	Aquila	301
	3338	Rob	341
	3339	Rob	341
	3340	Rob	341
	3344	Rob	341
	3345	Oscar	337
	3346	Oscar	337
	3347	Oscar	337
	3348	Oscar	337
	3349	Misha	423
	3350	Misha	423
	3353	Alabastro	361
	3358	Lambert	477
	3359	Lambert	477
	3409	Oscar	336
	3410	Oscar	336
	3411	Oscar	336
	3416	Hanka	438
	3417	Hanka	438
	3427	Pavel	347
	3428	Pavel	347
	3429	Pavel	347
	3430	Pavel	347
	3434	Lucas	339
	3435	Lucas	339
	3436	Lucas	339
	3437	Lucas	477
	3438	Lucas	477
	3439	Lucas	477
	3440	Galeti	314
	3464	Balthasar	474
	3468	Aslan	81
	3469	Aslan	81
	3470	Aslan	81

	3478	Linden	319
	3479	Linden	319
	3480	Jakub	482
	3500	Sherwood	350
	3508	Glory	141
	3509	Rodion	281
	3510	Everest	280
	3513	Svetlana	302
	3514	Svetlana	302
	3515	Svetlana	302
	3516	Lionel	421
	3517	Lionel	421
	3518	Nesrin	79
	3519	Nesrin	79
	3520	Nesrin	79
	3527	Maple	351
	3528	Maple	351
	3529	Saphira	300
	3530	Saphira	300
	3534	Belano	24
	3535	Belano	24
	3536	Belano	24
	3537	Belano	24
	3538	Belano	24
	3539	Belano	25
	3540	Belano	25
	3542	Zenaida	150
	3543	Zenaida	150
	3544	Zenaida	150
	3545	Zenaida	150
	3547	Fedora	228
	3548	Fedora	228
	3549	Fedora	228
	3550	Fedora	228
	3563	Disky	377
	3564	Disky	377
	3569	Rosanna	176
	3570	Rosanna	176
	3579	Miroslaw	155
	3580	Miroslaw	155
	3598	Ninelle	173
	3599	Ninelle	173
	3607	Harlow	18
	3640	Picture Guard	487
	3641	Picture Light	488
	3642	Picture Light	488
	3643	Picture Light	488
	3644	Picture Light	488
	3650	Picture Guard	487
NEW	3659	Cesario	320/8
	3680	Wasabi	454
	3687	Nedda	372
	3688	Nedda	372
	3689	Nedda	372
	3691	Elina	365
	3692	Elina	365
	3693	Elina	365
	3694	Elina	365
	3696	Wasabi	454
	3697	Phaedra	371

	3698	Phaedra	371
	3699	Phaedra	371
	3712	Laretta	359
	3713	Laretta	359
	3714	Laretta	359
	3721	Athen	217
	3722	Athen	217
	3723	Athen	217
	3750	Valter	328
	3850	Harmony Lux	367
	3851	Harmony Lux	366
	3852	Harmony Lux	366
	3853	Harmony Lux	366
	3854	Harmony Lux	367
	3855	Harmony Lux	367
	3856	Harmony Lux	367
	3859	Aldona	105
	3860	Aldona	105
	3874	Toma	475
	3875	Toma	475
	3887	Scottie	372
	3888	Scottie	372
	3889	Scottie	372
	3904	Alabastro	363
	3905	Alabastro	363
	3907	Picture Slim	487
	3908	Picture Slim	487
	3909	Picture Slim	487
	3910	Picture Slim	487
	3916	Sorina	202
	3917	Sorina	202
	3918	Sorina	202
	3926	Adeline	100
	3927	Adeline	100
	3928	Adeline	100
	3929	Adeline	100
	3934	Igor	321
	3936	Lucas	339
	3937	Lucas	339
	3938	Lucas	339
	3954	Alabastro	361
	3955	Alabastro	361
	3958	Balor	420
	3966	Soraya	200
	3967	Soraya	200
	3968	Soraya	200
	3969	Soraya	201
	3970	Soraya	201
	3976	Pablo	48
	3977	Pablo	48
	3978	Pablo	48
	3979	Pablo	48
	3980	Pablo	49
	3986	Lamar	52
	3987	Lamar	52
	3988	Lamar	52
	3989	Lamar	53
	3990	Lamar	53
	4019	Pearl Classic	398
	4020	Action	400

	4026	Action	400
	4028	Action	400
	4037	Bank	412
	4038	Bank	412
	4059	Diana	399
	4060	Action	400
	4061	Action	400
	4062	Action	400
	4064	Action	401
	4065	Action	401
	4067	Diana	399
	4068	Diana	399
	4075	Beta	396
	4076	Beta	396
	4077	Gamma	397
	4078	Gamma	397
	4091	Harmony	398
	4093	Ozone	457
	4096	Vesuvius	457
	4097	Fuji	455
	4106	Lollipop 2	451
	4108	Lollipop 2	451
	4109	Marshal	450
	4110	Marshal	450
	4111	Dovce	451
	4112	Dovce	451
	4113	Glitter	453
	4114	Glitter	453
	4115	Glitter	453
	4120	Rock	456
	4127	Rock	456
	4129	Rock	456
	4130	Rock	456
	4164	Dominic	422
	4167	Dominic	422
	4168	Dylan	429
	4169	Dylan	429
	4170	Dylan	429
	4171	Dylan	429
	4172	Dylan	429
	4178	Samson	425
	4179	Samson	425
	4188	Action	401
	4192	Thomas	403
	4195	Jeff	431
	4196	Jeff	431
	4197	Jeff	431
	4198	Jeff	431
	4199	Aksel	64
	4205	Patric	428
	4206	Patric	428
	4207	Patric	428
	4208	Patric	428
	4211	Samson	425
	4212	Samson	425
	4213	Samson	425
	4214	Arno	426
	4215	Arno	426
	4216	Arno	426
	4255	Clark	428

CONTENTS • TARTALOMJEGYZÉK • INHALTSVERZEICHNIS

New	Art. number	Name	Page
Új	Cikkszám	Név	Oldal
Neu	Art. nummer	Name	Seite

New	Art. number	Name	Page
Új	Cikkszám	Név	Oldal
Neu	Art. nummer	Name	Seite

New	Art. number	Name	Page
Új	Cikkszám	Név	Oldal
Neu	Art. nummer	Name	Seite

New	Art. number	Name	Page
Új	Cikkszám	Név	Oldal
Neu	Art. nummer	Name	Seite

	4257	Dennis	432
	4258	Dennis	432
	4259	Dennis	432
	4260	Dennis	432
	4328	Derek	69
	4329	Derek	69
	4334	Ronald	427
	4335	Ronald	427
	4347	Iduna	22
	4356	Clip	432
	4357	Clip	432
	4372	Evelyn	405
	4374	Dora	411
	4379	Ellie	407
	4380	Ellie	407
	4384	Ellie	407
	4386	Petra	411
	4391	Molly	406
	4392	Molly	406
	4398	Sophie	411
	4407	Colin	426
	4408	Colin	426
	4419	Raul	427
	4420	Raul	427
	4458	Orlando	406
	4475	Ingrid	408
	4476	Ingrid	408
	4477	Ingrid	408
	4478	Ingrid	408
	4479	Panthea	168
	4480	Panthea	168
	4504	Alfons	378
	4533	Millie	453
	4541	Murry	283
	4548	Sonal	405
	4549	Sonal	405
	4554	Gamma Trend	396
	4555	Gamma Trend	396
	4557	Shepherd	442
	4558	Cathy	441
	4559	Leon	440
	4560	Lanny	59
	4561	Lanny	59
	4563	Shepherd	442
	4564	Cathy	441
	4565	Leon	440
	4569	Shepherd	442
	4570	Cathy	441
	4571	Leon	440
	4605	Dorka	411
NEW	4606	Cyclone	308
	4613	Cupola Range	369
	4615	Cupola Range	369
	4631	Shepherd	442
	4632	Cathy	441
	4633	Leon	440
	4634	Tayla	316
	4647	Billy	446
	4649	Ramsey	20
	4650	Ramsey	20

	4658	Paris Lux	446
	4675	Smerlato	365
	4682	Murry	283
	4703	Push Light	444
	4717	Helicopter	437
	4718	Bee	437
	4754	Zille	22
	4780	Round	365
	4782	Vino	369
	4795	Vino	369
	4894	Rice	443
	4898	Rice	443
	4901	Ariel	409
	4904	Ariel	409
	4906	Ariel	409
	4907	Ariel	409
	4925	Parov	21
	4928	Orlando	406
	4929	Orlando	406
	4930	Orlando	406
	4948	Salem	405
	4949	Salem	405
	4950	Salem	405
	4980	Natina	229
	5009	Natina	229
	5010	Natina	229
	5011	Natina	229
	5014	Martha	270
	5015	Martha	270
	5016	Martha	270
	5017	Martha	270
	5018	Martha	270
	5021	Harold	463
	5022	Harold	463
	5023	Harold	463
	5024	Harold	463
	5045	Solange	232
	5046	Solange	232
	5047	Solange	232
	5048	Solange	232
	5052	Carmella	98
	5053	Carmella	98
	5054	Carmella	98
	5055	Carmella	98
	5056	Carmella	98
	5057	Carmella	98
	5059	Morris	384
	5060	Morris	384
	5062	Evron	485
	5063	Evron	485
	5064	Evron	485
	5066	Oswald	327
	5069	Zircon	88
	5070	Zircon	88
	5071	Zircon	89
	5072	Zircon	88
	5073	Zircon	89
	5074	Zircon	89
	5075	Zircon	89
	5076	Zircon	89

	5077	Miroslaw	155
	5078	Miroslaw	155
	5081	Renata	104
	5082	Renata	104
	5083	Renata	104
	5084	Renata	104
	5085	Norena	75
	5086	Norena	75
	5087	Aviva	468
	5088	Aviva	468
	5089	Alberta	78
	5092	Alberta	78
	5093	Aneta	108
	5094	Aneta	108
	5095	Aneta	108
	5096	Aneta	109
	5097	Aneta	109
	5098	Fauna	205
	5099	Fauna	205
	5101	Ufo	377
	5103	Ufo	376
	5113	Ufo	375
	5121	Ufo	375
	5131	Ufo	377
	5143	Ufo	375
	5151	Ufo	375
	5161	Ufo	377
	5163	Ufo	376
	5173	Ufo	375
	5181	Ufo	375
	5196	Jasna	333
	5203	Ufo	376
	5216	Greg	498
	5217	Greg	498
	5218	Greg	498
	5219	Greg	498
	5220	Wendy	410
	5221	Wendy	410
	5222	Donati	151
	5223	Donati	151
	5224	Sinopia	164
	5225	Sinopia	164
	5228	Sheila	138
	5229	Sheila	138
	5230	Celinda	297
	5233	Ufo	376
	5237	Rupert	23
	5238	Rupert	23
	5239	Daron	392
	5240	Daron	392
	5241	Daron	392
	5242	Egon	379
	5243	Egon	379
	5244	Fabian	38
	5245	Fabian	38
	5246	Fabian	39
	5247	Fabian	39
	5248	Donati	143
	5249	Donati	143
	5250	Donati	143

	5251	Donati	143
	5252	Petunia	142
	5253	Petunia	142
	5254	Ronnie	416
	5255	Ronnie	416
NEW	5256	Ocean	320/5
NEW	5258	Acantha	153
NEW	5259	Acantha	153
NEW	5260	Acantha	153
	5263	Ufo	376
NEW	5267	Casimir	320/5
NEW	5268	Casimir	320/5
NEW	5269	Casimir	320/5
NEW	5270	Daryl	36
NEW	5271	Daryl	36
NEW	5272	Daryl	36
NEW	5274	Coco	479
NEW	5275	Coco	479
NEW	5276	Coco	479
NEW	5280	Yordana	117
	5281	Indiana	40
	5282	Indiana	40
	5283	Indiana	41
	5284	Indiana	40
	5285	Sirius	303
	5286	Sirius	303
	5293	Kamala	35
	5295	Edmund	244
	5296	Edmund	244
	5297	Edmund	244
	5298	Edmund	244
	5299	Hestia	178
	5300	Hestia	178
	5301	Hestia	179
	5302	Hestia	179
	5303	Hestia	178
	5304	Hestia	179
	5305	Hestia	178
	5307	Dragan	66
	5308	Dragan	67
	5309	Dragan	66
	5310	Dragan	66
	5311	Trincola	72
	5312	Trincola	72
	5322	Konrad	237
	5323	Konrad	237
	5324	Konrad	237
	5325	Konrad	237
	5335	Oberon	28
	5336	Oberon	28
	5337	Oberon	28
	5338	Oberon	28
	5339	Oberon	29
	5340	Oberon	29
	5341	Lacey	218
	5342	Lacey	218
	5343	Lacey	219
	5344	Lacey	218
	5345	Lacey	219
	5346	Tamara	227

CONTENTS • TARTALOMJEGYZÉK • INHALTSVERZEICHNIS

New	Art. number	Name	Page
Új	Cikkszám	Név	Oldal
Neu	Art. nummer	Name	Seite

	5347	Tamara	227
	5348	Tamara	227
	5349	Tamara	227
	5351	Divina	167
	5352	Divina	167
	5353	Divina	167
	5354	Konrad	236
	5355	Konrad	236
	5356	Konrad	236
	5357	Konrad	236
NEW	5358	Aisha	118
	5359	Cortado	18
	5360	Cortado	18
	5361	Cortado	18
	5364	Ophelia	280
	5365	Ophelia	280
NEW	5366	Malcolm	320/3
	5367	Oleg	515
	5368	Oleg	515
	5369	Oleg	515
	5370	Oleg	515
	5371	Oleg	514
	5372	Oleg	514
	5373	Oleg	514
	5374	Oleg	514
	5379	Basil	112
	5380	Basil	112
	5381	Basil	112
	5382	Basil	112
	5383	Basil	112
	5394	Kassia	165
	5395	Kassia	165
	5396	Kassia	165
	5397	Salazar	226
	5398	Salazar	226
	5399	Salazar	226
	5400	Salazar	226
	5401	Ufo	374
	5407	Ufo	374
	5409	Baloo	443
	5410	Baloo	443
	5411	Ufo	374
	5417	Ufo	374
	5419	Adonias	286
	5420	Benicio	287
	5421	Ufo	374
	5427	Ufo	374
	5429	Timothy	422
	5435	Rob	340
	5436	Rob	340
	5445	Danny	320
	5446	Danny	320
	5447	Danny	320
	5448	Danny	320
	5449	Danny	320
	5450	Danny	320
	5469	Anais	404
	5470	Anais	404
	5489	Tony	464
	5490	Tony	464

New	Art. number	Name	Page
Új	Cikkszám	Név	Oldal
Neu	Art. nummer	Name	Seite

	5491	Tony	464
	5492	Tony	464
	5497	Steve	462
	5498	Steve	462
	5499	Steve	462
	5500	Steve	462
	5532	Jenna	260
	5533	Jenna	260
	5534	Jenna	260
	5539	Gavin	230
	5540	Damien	281
	5546	Holly	160
	5547	Holly	160
	5548	Holly	160
	5549	Holly	160
	5550	Holly	160
	5551	Holly	161
	5552	Holly	160
	5553	Holly	161
	5555	Holly	158
	5556	Holly	158
	5557	Holly	159
	5558	Holly	158
	5559	Holly	158
	5560	Holly	159
	5561	Holly	159
	5562	Holly	159
	5564	Karen	231
	5565	Karen	231
	5566	Karen	231
	5567	Karen	231
	5568	Lois	516
	5569	Lois	516
	5570	Lois	516
	5571	Lois	516
	5576	Lois	517
	5577	Lois	517
	5578	Lois	517
	5579	Lois	517
	5584	Lois	520
	5585	Lois	520
	5586	Lois	520
	5587	Lois	520
	5592	Otto	393
	5631	Finian	255
	5632	Finian	255
	5633	Finian	255
	5634	Finian	255
	5661	Hilary	113
	5662	Hilary	113
	5663	Hilary	113
	5664	Hilary	113
	5672	Anja	380
	5673	Dobra	380
	5674	Hanson	497
	5675	Magnus	444
	5681	Artemis	106
	5683	Artemis	106
	5684	Morpheus	106
	5685	Morpheus	106

New	Art. number	Name	Page
Új	Cikkszám	Név	Oldal
Neu	Art. nummer	Name	Seite

	5690	Connor	261
	5691	Connor	261
	5692	Ambrosio	123
	5693	Ambrosio	123
	5694	Ambrosio	123
	5713	Betty	472
	5714	Betty	472
	5716	Beata	467
	5717	Beata	467
	5718	Beata	467
	5719	Silas	480
	5720	Silas	480
	5721	John	481
	5726	Opale	373
	5727	Silas	480
	5729	Silas	480
	5730	Milo	444
	5732	John	481
	5739	Diana	399
	5745	Betty	472
	5746	Betty	472
	5749	Jim	472
	5750	Jim	472
	5770	Palmira	122
	5771	Palmira	122
	5772	Palmira	122
	5781	Bastian	485
	5782	Andrew	485
	5786	Abbey	483
	5787	Abbey	483
	5800	Periodic	490
	5808	Periodic	490
	5809	Periodic	490
	5810	Lentil	618
	5827	Togo	473
	5859	Montelle	296
	5890	Tulio	124
	5891	Tulio	124
	5895	Antonia	460
	5896	Antonia	460
	5897	John	481
	5902	Mac	245
	5903	Mac	245
	5904	Mac	245
	5905	Mac	245
	5943	Holly	82
	5944	Holly	82
	5945	Holly	82
	5946	Holly	83
	5947	Holly	83
	5948	Holly	82
	5949	Holly	82
	5962	Vivienne	235
	5963	Vivienne	235
	5964	Vivienne	235
	5965	Vivienne	235
	5966	Vivienne	234
	5967	Vivienne	234
	5968	Vivienne	234
	5969	Vivienne	234

New	Art. number	Name	Page
Új	Cikkszám	Név	Oldal
Neu	Art. nummer	Name	Seite

	5970	Elite	265
	5971	Elite	265
	5972	Elite	265
	5973	Elite	265
	5975	Ati	262
	5976	Ati	262
	5977	Ati	262
	5978	Ati	262
	5979	Ati	262
	5991	Norman	250
	5992	Norman	250
	5993	Norman	250
	5994	Norman	250
	5995	Norman	251
	5996	Norman	251
	5997	Norman	251
	5998	Norman	251
	6025	Ebony	233
	6026	Ebony	233
	6027	Ebony	233
	6028	Ebony	233
	6045	Norton	253
	6046	Norton	253
	6047	Norton	253
	6048	Norton	253
	6060	Elite	264
	6061	Elite	264
	6062	Elite	264
	6063	Elite	264
	6078	Polla	260
	6079	Polla	260
	6081	Dave	258
	6083	Dave	259
	6085	Dave	259
	6091	Lauren	259
	6092	Lauren	259
	6093	Lauren	259
	6094	Lauren	259
	6096	Logan	254
	6097	Logan	254
	6098	Logan	254
	6099	Logan	254
	6125	Merkur	249
	6126	Merkur	249
	6127	Merkur	249
	6128	Merkur	249
	6129	John	481
	6130	John	481
	6228	Rowena	21
	6230	Liam	471
	6250	Delion	296
	6258	Amadeo	90
	6259	Amadeo	90
	6260	Amadeo	90
	6270	Danton	482
	6294	Siren	315
	6299	Othello	101
	6300	Soma	266
	6301	Soma	266
	6302	Soma	266

CONTENTS • TARTALOMJEGYZÉK • INHALTSVERZEICHNIS

New	Art. number	Name	Page
Új	Cikkszám	Név	Oldal
Neu	Art. nummer	Name	Seite

New	Art. number	Name	Page
Új	Cikkszám	Név	Oldal
Neu	Art. nummer	Name	Seite

New	Art. number	Name	Page
Új	Cikkszám	Név	Oldal
Neu	Art. nummer	Name	Seite

New	Art. number	Name	Page
Új	Cikkszám	Név	Oldal
Neu	Art. nummer	Name	Seite

	6303	Soma	266
	6304	Soma	266
	6305	Soma	266
	6306	Soma	267
	6307	Soma	267
	6308	Soma	267
	6309	Soma	267
	6310	Soma	267
	6320	Soma	267
	6340	Linett	437
	6341	Aurel	257
	6342	Aurel	257
	6343	Aurel	257
	6344	Aurel	257
	6355	Solomon	91
	6356	Art Flower	269
	6357	Art Flower	269
	6358	Art Flower	269
	6359	Art Flower	269
	6389	Birdy	436
	6390	Birdy	436
	6408	Carter	424
	6409	Carter	424
	6410	Carter	424
	6448	Harris	430
	6486	Gavin	230
	6487	Gavin	230
	6488	Gavin	230
	6489	Gavin	230
	6490	Danuta	327
	6495	Philana	166
	6496	Philana	166
	6512	Karen	239
	6513	Karen	239
	6514	Karen	239
	6515	Karen	239
	6529	Larkin	381
	6539	Harvey	381
	6545	Grando	271
	6546	Grando	271
	6547	Grando	271
	6548	Grando	271
	6569	Bowie	415
	6570	Bowie	415
	6579	Leana	350
	6580	Leana	350
	6589	Ashton	305
	6590	Ashton	305
	6591	Soma	268
	6592	Soma	268
	6593	Soma	268
	6594	Soma	268
	6635	Harmony Lux	263
	6636	Harmony Lux	263
	6637	Harmony Lux	263
	6638	Harmony Lux	263
	6639	Godric	402
	6640	Godric	402
	6649	Neva	73
	6650	Neva	73

	6659	Cassandra	163
	6660	Cassandra	163
	6666	Karen	238
	6667	Karen	238
	6668	Karen	238
	6669	Karen	238
	6669	Karen	238
NEW	6670	Tithania	116
	6710	Dalfon	288
	6719	Mika	379
	6720	Mika	379
	6749	Paula	490
	6750	Paula	490
	6767	Nicolette	256
	6768	Nicolette	256
	6769	Nicolette	256
	6770	Nicolette	256
	6778	Berry	430
	6779	Berry	430
	6780	Berry	430
	6806	Larisha	175
	6808	Almus	55
	6809	Almus	55
	6814	Ashton	305
	6830	Roxana	128
	6835	Dave	258
	6836	Dave	258
	6837	Dave	258
	6838	Dave	258
	6857	Dalfon	288
	6858	Dalfon	289
	6859	Dalfon	289
	6867	Thabita	304
	6868	Thabita	304
	6869	Thabita	304
NEW	6890	Fulvia	320/8
NEW	6899	River	131
NEW	6905	Aztec	320/3
	6907	Almond	348
	6908	Almond	348
	6909	Almond	348
	6915	Gremio	414
	6949	Carnival	450
NEW	6955	Piero	118
	6958	Taneli	291
	6959	Taneli	291
	6960	Taneli	291
	6966	Jillian	315
	6967	Jillian	315
	6969	Willow	130
	6970	Willow	130
	6979	Osias	423
	6980	Osias	423
	6986	Norton Led	252
	6987	Norton Led	252
	6988	Norton Led	252
	6989	Norton Led	252
	6996	Fandral	311
	6997	Fandral	311
	7006	Vlasta	395
	7008	Glitter Rainbow	452

NEW	7010	Lentula	632
	7011	Lollipop Rainbow	452
	7017	Kaunas	92
	7018	Kaunas	92
	7019	Kaunas	92
	7020	Kaunas	92
	7021	Kaunas	92
	7022	Kaunas	92
	7023	Kaunas	93
	7024	Kaunas	93
	7025	Kaunas	93
	7026	Minka	448
	7027	Minka	448
	7028	Minka	448
	7029	Minka	448
	7030	Minka	448
NEW	7032	Medulin	632
NEW	7040	Odera	632
NEW	7052	Ganges	579
NEW	7060	Turda	620
	7062	Flood	634
	7063	Flood	634
	7064	Flood	634
	7065	Flood	634
	7066	Flood	635
	7067	Flood	635
	7068	Flood	635
NEW	7069	Haiti	621
NEW	7070	Zaton	572
	7072	Petronel	210
NEW	7074	Cyprus	578
	7076	Petronel	210
	7077	Petronel	210
	7078	Petronel	210
	7079	Petronel	210
	7091	Rustic 3	206
	7092	Rustic 3	206
	7093	Rustic 3	206
	7095	Rustic 3	206
	7109	Mendoza	597
	7110	Mendoza	597
	7118	Evangeline	203
	7119	Evangeline	203
	7120	Evangeline	203
	7127	Taverna	533
	7128	Taverna	533
	7129	Taverna	533
	7130	Taverna	533
	7131	Beckworth	199
	7133	Beckworth	199
	7134	Trogir	579
	7135	Beckworth	199
	7136	Beckworth	199
NEW	7146	Paravento	532
NEW	7147	Paravento	532
NEW	7148	Paravento	532
NEW	7149	Paravento	532
NEW	7150	Paravento	532
NEW	7155	Gorica	597
NEW	7158	Teplice	573

NEW	7159	Teplice	573
NEW	7166	Hongkong	581
NEW	7167	Hongkong	581
NEW	7195	Wales	528
NEW	7196	Wales	528
NEW	7197	Wales	528
	7201	Tristan	182
	7202	Tristan	182
	7203	Tristan	182
	7204	Ontario	596
	7205	Tristan	182
	7231	Rafaella	184
	7233	Rafaella	184
	7235	Rafaella	184
NEW	7236	Novigrad	572
NEW	7237	Novigrad	572
NEW	7238	Dubrovnik	534
NEW	7239	Dubrovnik	534
NEW	7240	Dubrovnik	534
	7241	Rafaella	184
	7243	Rafaella	184
NEW	7244	Orlova	572
	7245	Rafaella	184
NEW	7246	Durbe	588
NEW	7247	Durbe	588
NEW	7250	Pernik	615
	7259	Fabiola	214
	7260	Fabiola	214
	7261	Fabiola	214
NEW	7265	Pernik	615
NEW	7266	Savano	531
NEW	7267	Savano	531
NEW	7268	Savano	531
NEW	7269	Savano	531
	7274	Edith	188
	7275	Edith	188
	7276	Edith	188
NEW	7282	Rapla	579
	7317	Lippa	587
	7318	Lippa	587
	7319	Lippa	587
	7320	Lippa	587
	7361	Francesca	183
	7363	Francesca	183
	7365	Francesca	183
	7366	Colette	207
	7367	Colette	207
	7368	Colette	207
	7371	Francesca	185
	7372	Francesca	185
	7373	Francesca	185
	7375	Francesca	185
NEW	7379	Ankara	602
NEW	7380	Ankara	602
NEW	7386	Kolta	530
NEW	7387	Kolta	530
	7396	Solin	595
	7397	Solin	595
NEW	7406	Hort	616
NEW	7407	Hort	616

CONTENTS • TARTALOMJEGYZÉK • INHALTSVERZEICHNIS

New	Art. number	Name	Page	New	Art. number	Name	Page	New	Art. number	Name	Page	New	Art. number	Name	Page
Új	Cikkszám	Név	Oldal	Új	Cikkszám	Név	Oldal	Új	Cikkszám	Név	Oldal	Új	Cikkszám	Név	Oldal
Neu	Art. nummer	Name	Seite	Neu	Art. nummer	Name	Seite	Neu	Art. nummer	Name	Seite	Neu	Art. nummer	Name	Seite
NEW	7408	Hort	616		7896	Tartu	590		8140	Topeka	572		8248	Konstanz	562
NEW	7409	Hort	616		7897	Tartu	591		8141	Detroit	608		8261	Inox Torch	610
	7476	Balimo	594		7898	Tartu	591		8142	Detroit	608		8262	Inox Torch	610
	7477	Balimo	594		7899	Tartu	591		8143	Detroit	608		8263	Inox Torch	610
	7478	Balimo	594		7900	Tartu	591		8144	Detroit	608		8264	Inox Torch	610
	7479	Balimo	594		7904	Belfast	582		8145	Black Torch	605		8265	Inox Torch	611
	7502	Wellington	574		7914	Katowice	604		8146	Black Torch	605		8266	Inox Torch	611
	7503	Wellington	574		7915	Katowice	604		8147	Black Torch	605		8267	Inox Torch	611
	7504	Palanga	580		7916	Katowice	604		8148	Black Torch	605		8268	Inox Torch	611
	7505	Palanga	580		7925	Lima	581		8149	Akron	583		8269	Genova	577
	7506	Palanga	580		7929	Elva	582		8150	Akron	583		8270	Oslo	564
	7604	Zahara	43		7930	Elva	582		8154	Follina	586		8271	Oslo	565
	7640	Etrusco	360		7935	Halden	579		8163	Odessa	556		8337	Bonn	603
	7647	Etrusco	360		7951	Nesna	585		8164	Odessa	556		8338	Bonn	603
	7648	Etrusco	360		7952	Nesna	585		8165	Odessa	556		8339	Bonn	603
	7649	Etrusco	360		7955	Sintra	598		8166	Atlanta	609		8341	Milano	548
	7652	Etrusco	360		7956	Sintra	598		8167	Atlanta	609		8342	Milano	548
	7771	Dorothea	215		7959	Mandal	599		8168	Atlanta	609		8343	Milano	549
	7772	Dorothea	215		7960	Mandal	599		8169	Seattle	576		8344	Milano	549
	7773	Dorothea	215		7969	Amarillo	612		8170	Stuttgart	593		8345	Milano	549
	7774	Inverness	589		7970	Opava	622		8171	Regina	186		8346	Milano	549
	7775	Inverness	589		7975	Dannet	621		8172	Regina	186		8359	Manhattan	570
	7776	Dorothea	215		7976	Jezabel	162		8173	Regina	186		8365	Solar 1	620
	7777	Dorothea	215		7977	Jezabel	162		8175	Regina	187		8366	Solar 1	620
	7796	Opole	577		7978	Jezabel	162		8176	Regina	186		8370	Milano	546
	7797	Opole	577		7979	Eric	618		8177	Regina	186		8371	Milano	546
	7811	Athen	216		7980	Amarillo	612		8178	Regina	187		8372	Milano	546
	7812	Athen	216		7991	Sudan	208		8181	Monaco	538		8373	Milano	547
	7813	Athen	216		7992	Sudan	208		8182	Monaco	538		8374	Milano	547
	7814	Krobia	620		7993	Sudan	208		8183	Monaco	538		8375	Milano	547
	7815	Athen	217		7995	Sudan	208		8184	Monaco	539		8376	Milano	546
	7816	Athen	216		7996	Ecuador	577		8185	Monaco	539		8377	Madrid	558
	7817	Zombor	583		7997	Ecuador	577		8186	Monaco	539		8379	Madrid	559
	7818	Zombor	583		8011	Pueblo	613		8190	Darius	568		8380	Toronto	540
	7819	Zombor	583		8018	Chile	601		8201	Velence	551		8381	Toronto	540
	7820	Zombor	583		8019	Chile	601		8202	Velence	550		8382	Toronto	540
	7826	Lisbon	606		8020	Chile	601		8203	Velence	551		8383	Toronto	540
	7827	Lisbon	606		8029	Chile	601		8204	Velence	550		8384	Toronto	541
	7828	Lisbon	606		8030	Chile	601		8205	Velence	551		8385	Toronto	541
	7829	Lisbon	606		8034	Chile	601		8206	Velence	550		8387	Sydney	567
	7836	Madrid	558		8049	Alvorada	596		8207	Velence	551		8388	Sydney	567
	7837	Milano	548		8060	Bona	579		8208	Velence	550		8391	Toscana	545
	7850	Yola	633		8069	Pavia	563		8209	Velence	551		8392	Toscana	545
	7860	Enna	211		8070	Pavia	563		8210	Velence	550		8393	Toscana	545
	7868	Enna	211		8072	Marvel	213		8216	Velence	551		8394	Toscana	545
	7869	Enna	211		8076	Marvel	213		8217	Velence	550		8395	Toscana	545
	7870	Enna	211		8078	Marvel	213		8218	Velence	552		8396	Toscana	544
	7877	Funghetto	633		8086	Mirella	212		8220	Stuttgart	593		8397	Toscana	544
	7880	Ostrava	623		8087	Mirella	212		8227	Stuttgart	593		8398	Toscana	544
	7881	Ostrava	623		8088	Mirella	212		8229	Seattle	576		8399	Toscana	544
	7884	Almada	537		8089	Mirella	212		8232	Velence	552		8400	Toscana	544
	7885	Almada	537		8090	Mirella	212		8234	Velence	552		8409	Roma	571
	7886	Almada	537		8091	Marvel	213		8236	Velence	552		8410	Roma	571
	7887	Buffalo	598		8104	Bilbao	621		8238	Velence	552		8451	Nizza	542
	7888	Buffalo	598		8114	Salvador	596		8240	Velence	552		8452	Nizza	542
	7891	Silistra	575		8118	Phoenix	599		8243	Haga	567		8453	Nizza	542
	7892	Silistra	575		8119	Phoenix	599		8244	Haga	567		8454	Nizza	542
	7893	Tartu	590		8130	Navia	586		8245	Konstanz	562		8455	Nizza	542
	7894	Tartu	590		8134	Varna	578		8246	Konstanz	562		8458	Nizza	542
	7895	Tartu	590		8135	Varna	578		8247	Konstanz	562		8460	Toronto	541

CONTENTS • TARTALOMJEGYZÉK • INHALTSVERZEICHNIS

New	Art. number	Name	Page
Új	Cikkszám	Név	Oldal
Neu	Art. nummer	Name	Seite

New	Art. number	Name	Page
Új	Cikkszám	Név	Oldal
Neu	Art. nummer	Name	Seite

New	Art. number	Name	Page
Új	Cikkszám	Név	Oldal
Neu	Art. nummer	Name	Seite

New	Art. number	Name	Page
Új	Cikkszám	Név	Oldal
Neu	Art. nummer	Name	Seite

	8476	Madrid	558
	8477	Madrid	558
	8478	Madrid	558
	8479	Madrid	559
	8480	Madrid	559
	8496	Hektor	568
	8499	Hektor	568
	8510	Manhattan	570
	8511	Roma	571
	8541	Marlene	192
	8542	Marlene	192
	8543	Marlene	192
	8546	Marlene	192
	8547	Marlene	192
	8558	Orchidea	198
	8568	Marseille	561
	8569	Marseille	561
	8570	Marseille	561
	8578	Marseille	561
	8617	Marseille	560
	8618	Marseille	560
	8619	Marseille	560
	8620	Marseille	561
	8631	Annabella	196
	8632	Annabella	196
	8633	Annabella	196
	8634	Annabella	196
	8636	Annabella	197
	8637	Annabella	197
	8638	Annabella	196
	8670	Miami	554
	8671	Miami	554
	8674	Miami	554
	8676	Miami	554
	8677	Barcelona	557
	8678	Barcelona	557
	8679	Barcelona	557
	8680	Oslo	566
	8681	Oslo	565
	8682	Oslo	566
	8683	Stuttgart	593
	8684	Stuttgart	593
	8685	Stuttgart	593
	8686	Vigo	563
	8687	Vigo	563
	8696	New York	555
	8697	New York	555
	8698	New York	555
	8699	New York	555
	8700	New York	555
	8714	Tacoma	621
	8716	Oslo	566
	8717	Oslo	566
	8730	Baltimore	584
	8731	Baltimore	584
	8736	Oslo	565
	8737	Oslo	565
	8739	Oslo	565
	8740	Oslo	565
	8748	Innsbruck	570

	8749	Innsbruck	570
	8753	Norvich	575
	8754	Norvich	575
	8763	Oslo	564
	8764	Oslo	564
	8766	Durango	569
	8767	Durango	569
	8776	Roma	571
	8795	Birmingham	570
	8797	Austin	596
	8799	Sevilla	576
	8800	Sevilla	576
	8811	Flossi	193
	8812	Flossi	193
	8813	Flossi	193
	8815	Flossi	193
	8830	Andorra	597
	8832	Medina	600
	8833	Medina	600
	8834	Medina	600
	8835	Medina	600
	8847	Hamburg	592
	8848	Hamburg	592
	8849	Hamburg	592
	8850	Hamburg	592
	8873	Maribor	585
	8874	Maribor	585
	8888	Budapest	536
	8889	Budapest	536
	8890	Budapest	536
	8893	Trento	613
	8894	Trento	613
	8940	Rodez	576
	8948	Mora	633
	8949	Mora	633
	9919	Fix	383
	9920	Fix	383
	9921	Rolly	385
	9923	Rolly	385
	9926	Fix	383
NEW	71001	Faramir	513
NEW	71002	Faramir	513
NEW	71003	Cooperius	323
NEW	71004	Nefertum	278
NEW	71005	Cirilla	306
NEW	71006	Sotiris	310
NEW	71007	Sotiris	310
NEW	71008	Irelia	120
NEW	71009	Horacio	285
NEW	71010	Tumnus	303
NEW	71011	Tumnus	303
NEW	71012	Demetrius	307
NEW	71013	Athelstan	307
NEW	71014	Athelstan	307
NEW	71015	Benedick	278
NEW	71016	Faustine	284
NEW	71017	Katina	322
NEW	71018	Katina	322
NEW	71019	Negan	309
NEW	71020	Negan	309

NEW	71021	Boire	34
NEW	71022	Manzur	55
NEW	71023	Boire	34
NEW	71024	Boire	34
NEW	71025	Rattan	45
NEW	71026	Branwen	51
NEW	71027	Boroo	35
NEW	71028	Ubul	46
NEW	71030	Nikolaus	298
NEW	71031	Chadwick	135
NEW	71034	Chadwick	135
NEW	71035	Cerrigen	282
NEW	71036	Cerrigen	282
NEW	71037	Tesia	97
NEW	71038	Tesia	97
NEW	71039	Tesia	96
NEW	71040	Tesia	96
NEW	71041	Tesia	96
NEW	71042	Tesia	96
NEW	71043	Cadmus	19
NEW	71080	Niyilah	148
NEW	71083	Niyilah	148
NEW	71084	Tamur	117
NEW	71091	Adalla	42
NEW	71101	Vendel	342
NEW	71102	Vendel	342
NEW	71103	Vendel	342
NEW	71104	Vendel	342
NEW	71105	Vendel	342
NEW	71106	Vendel	342
NEW	71107	Vendel	343
NEW	71108	Vendel	343
NEW	71109	Vendel	343
NEW	71110	Prue	294
NEW	71111	Gremin	294
NEW	71112	Gremin	294
NEW	71113	Bitsi	295
NEW	71114	Bitsi	295
NEW	71115	Bitsi	295
NEW	71116	Shiena	133
NEW	71117	Taytum	334
NEW	71118	Epورا	332
NEW	71119	Nessira	332
NEW	71120	Nessira	332
NEW	71121	Liatris	333
NEW	71122	Sabira	133
NEW	71123	Rorik	346
NEW	71124	Rorik	346
NEW	71125	Rorik	346
NEW	71126	Engon	330
NEW	71127	Engon	331
NEW	71128	Engon	330
NEW	71129	Engon	331
NEW	71130	Engon	330
NEW	71131	Engon	331
NEW	71132	Lucas	355
NEW	71133	Lucas	355
NEW	71134	Lucas	355
NEW	72001	Ceilo	103
NEW	72002	Ceilo	103

NEW	72003	Ormini	45
NEW	72004	Sombero	22
NEW	72005	Leandros	14
NEW	72006	Leandros	14
NEW	72007	Jarod	73
NEW	72008	Jarod	73
NEW	72009	Irelia	120
NEW	72010	Fringilla	119
NEW	72011	Temperius	115
NEW	72012	Shivani	157
NEW	72013	Wilbour	70
NEW	72014	Wilbour	70
NEW	72015	Zuriel	51
NEW	72016	Felipe	71
NEW	72017	Alatar	71
NEW	72018	Aslaug	16
NEW	72019	Dilara	17
NEW	72020	Esilda	119
NEW	72021	Dvora	137
NEW	72023	Dvora	137
NEW	72025	Rattan	45
NEW	72027	Branwen	51
NEW	72033	Chadwick	135
NEW	72041	Callum	32
NEW	72043	Callum	32
NEW	72051	Ronno	134
NEW	72053	Ronno	134
NEW	72054	Ronno	134
NEW	72061	Peyton	147
NEW	72063	Peyton	147
NEW	72071	Dollien	50
NEW	72075	Dollien	50
NEW	72081	Niyilah	148
NEW	72083	Niyilah	148
NEW	72084	Tamur	117
NEW	72091	Adalla	42
NEW	72093	Adalla	42
NEW	72101	Lissandra	136
NEW	72103	Lissandra	136
NEW	72111	Emrys	15
NEW	72113	Emrys	15
NEW	72121	Toras	87
NEW	72123	Tanno	144
NEW	72124	Toras	87
NEW	72125	Tanno	145
NEW	72131	Braulia	33
NEW	72133	Braulia	33
NEW	72141	Tanno	144
NEW	73001	Aberama	243
NEW	73002	Aberama	243
NEW	73003	Aberama	243
NEW	73004	Aberama	243
NEW	73011	Konrad	242
NEW	73012	Konrad	242
NEW	73013	Konrad	242
NEW	73014	Konrad	242
NEW	73121	Toras	86
NEW	73122	Toras	86
NEW	73123	Toras	86
NEW	73124	Toras	87

CONTENTS • TARTALOMJEGYZÉK • INHALTSVERZEICHNIS

New	Art. number	Name	Page
Új	Cikkszám	Név	Oldal
Neu	Art. nummer	Name	Seite

New	Art. number	Name	Page
Új	Cikkszám	Név	Oldal
Neu	Art. nummer	Name	Seite

New	Art. number	Name	Page
Új	Cikkszám	Név	Oldal
Neu	Art. nummer	Name	Seite

New	Art. number	Name	Page
Új	Cikkszám	Név	Oldal
Neu	Art. nummer	Name	Seite

NEW	74001	Mosley	417
NEW	74002	Ferb	417
NEW	74003	Azím	403
NEW	74004	Rader	388
NEW	74005	Luigi	388
NEW	74006	Boire	34
NEW	74007	Adelmo	390
NEW	74008	Adelmo	390
NEW	74009	Adelmo	390
NEW	74010	Adelmo	390
NEW	74011	Izander	402
NEW	74012	Izander	402
NEW	74013	Hardin	419
NEW	74014	Hardin	419
NEW	74015	Deshal	420
NEW	74016	Alinafe	43
NEW	74017	Monet	139
NEW	74040	Callum	32
NEW	74050	Ronno	134
NEW	74120	Tanno	144
NEW	75001	Attichus	465
NEW	75002	Attichus	465

NEW	75003	Attichus	465
NEW	75004	Attichus	465
NEW	75005	Tirina	470
NEW	75006	Tirina	470
NEW	75007	Togo	473
NEW	75008	Klementine	475
NEW	75009	Larcia	476
NEW	75010	Larcia	476
NEW	75011	Larcia	353
NEW	75012	Larcia	353
NEW	75013	Vendel	354
NEW	75014	Vendel	354
NEW	75015	Vendel	354
NEW	75016	Turgon	480
NEW	75017	Turgon	480
NEW	76001	Akali	445
NEW	76002	Akali	445
NEW	76003	Pirit	447
NEW	76004	Siggy	447
NEW	76005	Buldus	418
NEW	76007	Ishtar	413
NEW	76009	Igdrasil	454

NEW	76010	Taena	413
NEW	76011	Abel	446
NEW	76012	Dembo	446
NEW	76013	Taena	413
NEW	77001	Wigry	630
NEW	77002	Bobus	630
NEW	77003	Ximpu	630
NEW	77004	Narmada	624
NEW	77005	Qesa	624
NEW	77006	Brezno	626
NEW	77007	Skadar	631
NEW	77008	Treppio	631
NEW	77009	Zrebar	625
NEW	77010	Certovo	625
NEW	77011	Kelna	628
NEW	77012	Zlarin	628
NEW	77013	Sepik	628
NEW	77014	Moselle	626
NEW	77015	Kapuas	624
NEW	77016	Ansoo	631
NEW	77017	Alaska	627
NEW	77018	Alaska	627

NEW	77019	Valpovo	629
NEW	77020	Lihull	629
NEW	77021	Dojran	629
NEW	77022	Rogova	622
NEW	77023	Korana	625
NEW	77024	Kangton	627
NEW	77025	Ankara	602
NEW	77026	Ankara	602
NEW	77027	Teplice	573
NEW	77028	Hitura	618
NEW	77029	Hitura	618
NEW	78001	Gaten	486
NEW	78002	Gaten	486
NEW	78003	Greg	499
NEW	78004	Greg	499
NEW	78005	Greg	499
NEW	78006	Greg	499
NEW	78026	Hanson	497
NEW	78027	Duddu	493
NEW	78028	Duddu	493
NEW	78029	Duddu	493
NEW	78030	Duddu	493

CONTENTS • TARTALOMJEGYZÉK • INHALTSVERZEICHNIS

Name	Page
Név	Oldal
Name	Seite

Abbey	483
Abel	446
Aberama	243
Acantha	153
Achilles	320/1
Action	400, 401
Ada	368
Adalla	42
Adeline	100
Adelmo	390
Adonias	286
Adrienne	126
Aisha	118
Akali	445
Akron	583
Aksel	64
Alabastro	361, 362, 363
Alaska	627
Alatar	71
Alberta	78
Albina	484
Aldona	105
Alessandra	220, 221
Aletta	189
Alexis	308
Alfons	378
Alinafe	43
Almada	537
Almond	348
Almus	55
Alvaro	60, 61
Alvorada	596
Amadeo	90
Amarillo	612
Ambrosio	123
Amy	261
Anais	404
Anastasia	110, 111
Andorra	597
Andrew	485
Aneta	108, 109
Aniela	127
Anja	380
Ankara	602
Annabella	196, 197
Ansoo	631
Antoine	469
Antonia	460
Aquila	301
Ariel	409
Aristeo	394
Arno	426
Art Flower	269
Art Gold	359
Artemis	106
Ashton	305
Aslan	81
Aslaug	16
Athelstan	307
Athen	216, 217
Ati	262
Atlanta	609

Name	Page
Név	Oldal
Name	Seite

Attichus	465
Aurel	257
Austin	596
Avalon	129
Aviva	468
Azim	403
Aztec	320/3
Balimo	594
Baloo	443
Balor	420
Balthasar	474
Baltimore	584
Band Light	500, 501
Bank	412
Barcelona	557
Basil	112
Bastian	485
Bath	494
Batten Light	496
Beata	467
Becca	466
Beckworth	199
Bee	437
Belano	24, 25
Belfast	582
Benedick	278
Benicio	287
Benita	335
Berry	430
Beta	396
Betty	472
Bilbao	621
Billy	446
Birdy	436
Birmingham	570
Bitsi	295
Black Torch	605
Blake	248
Blanka	404
Bloomy	368
Bobus	630
Boire	34
Bona	579
Bonn	603
Boogie	414
Boroo	35
Bottom	385
Bowie	415
Branwen	51
Braulia	33
Brezno	626
Briella	169
Bruce	318
Bruno	414
Budapest	536
Buffalo	598
Bulduş	418
Cadmus	19
Calista	80
Callia	23
Callum	32
Calvin	317

Name	Page
Név	Oldal
Name	Seite

Cardamom	146
Carmella	98
Carnival	450
Carter	424
Casimir	320/5
Caspar	54
Cassandra	163
Cathy	441
Ceilo	102, 103
Celinda	297
Cerrigen	282
Certovo	625
Cesario	320/8
Chadwick	135
Chile	601
Cinnamon	84
Cirilla	306
Clark	428
Clip	432
Coco	479
Colette	207
Colin	426
Connor	261
Cooperius	323
Coralia	315
Corinna	174
Cortado	18
Cressida	313
Cupola Range	369
Cyclone	308
Cyprus	578
Dalfon	288, 289
Damek	344
Damien	281
Danielle	177
Danila	181
Dannet	621
Danton	482
Danuta	327
Danny	320
Darius	568
Daron	392
Daryl	36
Dave	258, 259
Delion	296
Dembo	446
Demetrius	307
Dennis	432
Derek	69
Deshal	420
Detroit	608
Diana	399
Dilara	17
Dimitri	26, 27
Disky	377
Divina	167
Dobra	380
Dojran	629
Dollien	50
Dominic	422
Donald	512
Donatella	125

Name	Page
Név	Oldal
Name	Seite

Donati	143, 151
Dora	411
Dorka	411
Dorothea	215
Doug	65
Dovce	451
Draco	389
Dragan	66, 67
Drop Light	619
Dubrovnik	534
Duchess	170, 171
Duddu	493
Durango	569
Durbe	588
Dvora	137
Dylan	429
Easy Light	491
Ebony	233
Ecuador	577
Edith	188
Edmund	244
Egon	379
Eldrick	325
Elina	365
Elisett	194, 195
Elite	264, 265
Ellie	407
Elva	582
Emily	204
Emrys	15
Engon	330, 331
Enna	211
Epora	332
Eric	618
Esilda	119
Etrusco	360
Eucalyptus	116
Evan	461
Evangeline	203
Evelyn	405
Everest	280
Evron	485
Fabian	38, 39
Fabiola	214
Fandral	311
Fanny	416
Faramir	513
Farfalle	37
Fauna	205
Faustine	284
Fedora	228
Felipe	71
Ferb	417
Fidel	56, 57
Finian	255
Fix	383
Fixy	382
Flint	391
Flood	634, 635
Flores	455
Flossi	193
Follina	586

CONTENTS • TARTALOMJEGYZÉK • INHALTSVERZEICHNIS

Name	Page
Név	Oldal
Name	Seite

Foster	352
Francesca	183, 185
Fringilla	119
Fuji	455
Fulvia	320/8
Funghetto	633
Galeti	314
Gamma	397
Gamma Trend	396
Ganges	579
Gaten	486
Gavin	230
Genova	577
Glitter	453
Glitter Rainbow	452
Glory	141
Godric	402
Gorica	597
Grace	373
Grando	271
Greg	498, 499
Gremin	294
Gremio	414
Grendel	30, 31
Haga	567
Haiti	621
Halden	579
Hamburg	592
Hanka	438
Hanson	497
Hardin	419
Harlow	18
Harmony	398
Harmony Lux	263, 366, 367
Harold	463
Harris	430
Harvey	381
Hecate	299
Heimdall	320/6
Hekla	457
Hektor	568
Helicopter	437
Herkules	320/4
Hestia	178
Hilary	113
Hitura	618
Holden	358
Holly	82, 83, 158, 159, 160, 161
Hongkong	581
Horacio	285
Hort	616
Horus	412
Iduna	22
Igdrasil	454
Igor	321
Indiana	40, 41
Indigo	46, 47
Ingrid	408
Innsbruck	570
Inox Torch	610, 611

Name	Page
Név	Oldal
Name	Seite

Inverness	589
Irelia	120
Ishtar	413
Izander	402
Jakub	482
Jarod	73
Jasna	333
Jeff	431
Jenna	260
Jezabel	162
Jillian	315
Jim	472
Joel	198
John	481
Jolly	364
Justin	421
Kaia	74
Kamala	35
Kangton	627
Kapuas	624
Karen	231, 238, 239
Kassia	165
Katina	322
Katowice	604
Kaunas	92, 93
Kelna	628
Kinga	404
Klementine	475
Kobald	510, 511
Kolta	530
Konrad	236, 237, 242
Konstanz	562
Korana	625
Krobia	620
Kyle	65
Lacey	218, 219
Lagertha	326
Lamar	52, 53
Lambert	477
Lanny	58, 59
Larcia	353, 476
Laretta	359
Larisha	175
Larkin	381
Lauren	259
Leana	350
Leandros	14
Lentil	618
Lentula	632
Leon	440
Leonie	317
Levon	484
Liam	471
Liatris	333
Lihull	629
Lilian	205
Lima	581
Lina	444
Linden	319
Linett	437
Lionel	421
Lippa	587

Name	Page
Név	Oldal
Name	Seite

Lisbon	606
Lissandra	136
Lite	522, 523
Logan	254
Lois	516, 517, 518, 519, 520
Lollipop 2	451
Lollipop Rainbow	452
Lucas	338, 339, 355, 477
Ludovic	489
Luigi	388
Lupita	290
Lychee	403
Lydia	415
Mac	245
Maddox	512
Madrid	558, 559
Magnus	444
Malcolm	320/3
Malia	68
Mandal	599
Manhattan	570
Manorca	76
Manzur	55
Maple	351
Marcella	177
Marian	190, 191
Maribor	585
Marlene	192
Marlon	85
Marseille	560, 561
Marshal	450
Martha	270
Marvel	213
Mason	324
Matea	328
Matt	483
Medina	600
Medulin	632
Melissa	180
Mendoza	597
Meredith	114
Meridia	132
Merkur	249
Miami	554
Miguel	107
Mika	379
Milano	546, 547, 548, 549
Millie	453
Milo	444
Minka	448
Mirella	212
Miroslaw	155
Misha	423
Mokka	329
Molly	406
Monaco	538, 539
Monet	139
Montelle	296
Monty	417
Mora	633

Name	Page
Név	Oldal
Name	Seite

Morpheus	106
Morris	384
Moselle	626
Mosley	417
Murry	283
Nalani	410
Narmada	624
Natina	229
Navia	586
Nayara	320/7
Nedda	372
Nefertum	278
Negan	309
Nesna	585
Nesrin	79
Nessira	332
Neva	73
New York	555
Niagara	468
Nicolette	256
Nikolaus	298
Nilfgard	418
Ninelle	173
Niyilah	148
Nizza	542
Noah	433
Nolan	318
Norena	75
Norman	250, 251
Norton	253
Norton Led	252
Norwich	575
Novigrad	572
Oberon	28, 29
Ocean	320/5
Octav	326
Odera	632
Odessa	556
Oleg	514, 515
Ontario	596
Opale	373
Opava	622
Ophelia	280
Ophus	395
Opole	577
Orchidea	198
Orlando	406
Orlova	572
Ormini	45
Oscar	336, 337
Osias	423
Oslo	564, 565, 566
Ostrava	623
Oswald	327
Othello	101
Otilia	105
Otto	393
Ozone	457
Pablo	48, 49
Palanga	580
Pallas	172
Palmira	122

CONTENTS • TARTALOMJEGYZÉK • INHALTSVERZEICHNIS

Name	Page
Név	Oldal
Name	Seite

Panthea	168
Paravento	532
Paris Lux	446
Parov	21
Patric	428
Paula	490
Pavel	347
Pavia	563
Pearl Classic	398
Periodic	490
Pernik	615
Petra	411
Petronel	210
Petunia	142
Peyton	147
Phaedra	371
Philana	166
Phoenix	599
Picture Guard	487
Picture Light	488
Picture Slim	487
Piero	118
Pirit	447
Polla	260
Portia	297
Primrose	314
Prudence	154
Prue	294
Pueblo	613
Pumpkin	446
Push Light	444
Qesa	624
Quince	320/6
Rader	388
Rafaella	184
Ramsey	20
Randy	521
Rapla	579
Rasmus	320/2
Rattan	44, 45
Raul	427
Regina	186, 187
Renata	104
Rice	443
River	131
Rob	340, 341
Rock	456
Rodez	576
Rodion	281
Rogova	622
Rolly	385
Rolly Pull	385
Roma	571
Ronald	427

Name	Page
Név	Oldal
Name	Seite

Ronnie	416
Ronno	134
Rorik	346
Rosanna	176
Rotem	63
Round	365
Rowena	21
Roxana	128
Roxy	382
Rufin	414
Rupert	23
Rustic 3	206
Sabira	133
Sadie	83
Salazar	226
Salem	405
Salvador	596
Samson	425
Saphira	300
Savano	531
Scottie	372
Scroll	368
Seattle	576
Sedona	298
Selena	312
Sepik	628
Sevilla	576
Shaun	478, 504, 505, 506, 507, 508, 509
Sheila	138
Shepherd	442
Sherwood	350
Shiena	133
Shivani	157
Sigurd	320/8
Siggy	447
Silas	480
Silistra	575
Simple	370
Sinopia	164
Sintra	598
Siren	315
Sirius	303
Skadar	631
Slava	478
Slim	492
Smerlato	365
Soft	495
Solange	232
Solar 1	620
Soley	370
Solin	595
Solo	240, 241

Name	Page
Név	Oldal
Name	Seite

Solomon	91
Soma	266, 267, 268
Sombero	22
Sonal	405
Sonnet	352, 513
Sophie	411
Soraya	200, 201
Sorina	202
Sotiris	310
Spiral	370
Spot Fashion	521
Spot Relight	524, 525
Steve	462
Stregobor	320/4
Stuttgart	593
Sudan	208
Sullivan	140
Svetlana	302
Sydney	567
Tacoma	621
Taena	413
Taleb	345
Tamara	227
Tamino	349
Tamur	117
Taneli	291, 292, 293
Tanno	144, 145
Tarien	224
Tartu	590, 591
Tatjana	320/7
Taverna	533
Tayla	316
Taytum	334
Tekla	430
Temperius	115
Teplice	573
Tesia	94, 95, 96, 97
Thabita	304
Thomas	403
Timothy	422
Tirina	470
Tithania	116
Togo	473
Toma	475
Tony	464
Topeka	572
Toras	86, 87
Tornado	290
Toronto	540, 541
Toscana	544, 545
Trento	613
Treppio	631
Trevor	321
Trincola	72

Name	Page
Név	Oldal
Name	Seite

Tristan	182
Triton	320/1
Trogir	579
Tulio	124
Tumnus	303
Turda	620
Turgon	480
Ubul	46
Ufo	374, 375, 376, 377
Ursula	152
Valpovo	629
Valter	328
Varna	578
Velence	550, 551, 552
Vendel	342, 343, 354
Vesta	301
Vesuvius	457
Vigo	563
Vino	369
Vivienne	234, 235
Vlasta	395
Wales	528
Wasabi	454
Wellington	574
Wendy	410
Wigry	630
Wilbour	70
Willow	130
Wolimir	474
Ximpu	630
Yago	471
Yola	633
Yordana	117
Zahara	43
Zaton	572
Zelkova	156, 157
Zenaida	150
Zenith	300
Zenon	617
Zeus	246
Zille	22
Zircon	88, 89
Ziva	313
Zlarin	628
Zombor	583
Zrebar	625
Zuriel	51

BEST OF RABALUX

EN To close our catalogue please accept a photo montage compiled from our favourite products.

HU Katalógusunk zárásaként fogadják szeretettel kedvenc termékeinkből összeállított fotó montázsunkat!

DE Zum Abschluß unseres Katalogs empfangen Sie bitte eine Fotomontage, die wir aus unseren Lieblingsprodukten zusammengestellt haben.



72075



3178

BEST OF RABALUX



IMPRINT • IMPRESSZUM • IMPRESSUM

English

Colour and pattern discrepancy are possible. We are entitled to change the pattern.
We don't bear the responsibility of the printing failure.

Magyar

Szín és minta eltérés lehetséges. A minta változtatás jogát fenntartjuk!
Az esetleges nyomdai hibákért elnézésüket kérjük és azokért felelősséget nem vállalunk.

Deutsch

Farbe und Musterunterschied ist möglich. Wir halten das Recht von Musteränderung aufrecht.
Vor die eventuellen Druckfehler bitten wir um Entschuldigung und vor die Fehler können wir die Verantwortung nicht übernehmen.

Français

Il est bien possible d'avoir quelques alternances de la coloration et du modèle. Nous soutenons notre droit aux changements de modèles.
Excusez-nous des éventuelles fautes d'imprimerie dont nous ne nous considérons pas être les responsables.

Česky

Prodejce si vyhrazuje právo průběžně modifikovat své výrobky a tedy údaje uvedené v tomto katalogu mohou být bez předchozího oznámení změněny.
Tiskové chyby vyhrazeny.

Slovensko

Obstaja možnost odstopanja pri odenku barve izdelka. Pridržujemo si pravico do spremembe vzorca.
Ne prevzemamo odgovornosti za morebitne tiskarske napake.

Polski

Możliwe są odchylenia w kolorach i wzorach. Podtrzymujemy prawo zachowania zmiany wzoru.
Przepraszamy, a zarazem nie ponosimy odpowiedzialności za ewentualne błędy powstałe w druku.

Українська

Можлив зм ни у вз рцях та кольорах. Ми можемо зм нити вз рц на св й розсуд.
За можлив друкарськ помилки просимо вибачення та в дпов дальност не несемо.

Română

Este posibilă alternanța model/culoare. Ne reținem dreptul de a schimba modelele.
Pentru eventualele greseli de tipar, Vă cerem scuze ;dar nu ne asumăm răspunderea pentru ele.

Srpski

Moguće su razlike u bojama i šarama. Zadržavamo pravo na promene šara.
Za moguće štamparske greške unapred se izvinjavamo i za njih ne primamo na sebe odgovornost.

Hrvatski

Postoji mogućnost odstupanja u nijansi boje artikla.
Ne snosimo odgovornost u slučaju pogreške u tisku.

Slovensky

Predávajúci si vyhradzuje právo priebežne modifikovať svoje výrobky a preto aj údaje uvedené v tomto katalógu,
môžu byť zmenené bez predchádzajúceho oznámenia.
Za prípadné tlačové chyby nenesieme zodpovednosť.

български

Възможни са промени в цветовете и нюансите.
Ние не носим отговорност за печатни грешки.

Lietuvių

Galimi spalvų ir rašto netikslumai. Pasiliekiame teisę keisti raštą.
Atsiprašome, bet už spausdinimo klaidas neprisiimame atsakomybės.

Latviešu

Ir iespējamas krāsas un modeļa neatbilstības. Mēs paturam tiesības mainīt modeli.
Atvainojamies, tomēr neuzņemamies atbildību par drukas kļūdām.

Eesti

Värv ja muster võib erineda. Jätame endale õiguse mustri muutmiseks.
Vabandame, kuid ei vastuta trükkivigade eest.

Grafikai munkák: Visionext Reklámstúdió
Nyomdai munkák: Keskeny és Társai 2001 Kft.

