

MAYTONi
DECORATIVE LIGHTING

MAYTONI

STYLE, DESIGN, QUALITY

**WE CREATE IMPECCABLE LIGHT
WITH EVERY DETAIL CONSIDERED
THE IMPORTANCE OF DETAILS.**

With an eye on new tendencies, we are constantly broadening our collections, taking into consideration the specificities of different markets. The Maytoni Design Studio develops new products and studies the latest trends to offer smart lighting solutions to our clients.

We take part to the most important trade shows worldwide: Light+Building, Maison et Objet, Mos-Build, I Saloni.

We are a young, dynamic and fast-growing company based in Germany.

We offer a big variety of decorative products for all tastes, needs and markets: from classic to modern, from technical to outdoor.

Being operative in more than 30 countries gives us an international approach to new trends and opportunities.



▲
SATELLITE
MOD102PL-L42B



▲
TONE
P001PL-01BZ

▶
AVOLA
MOD431-PL-01
-WG

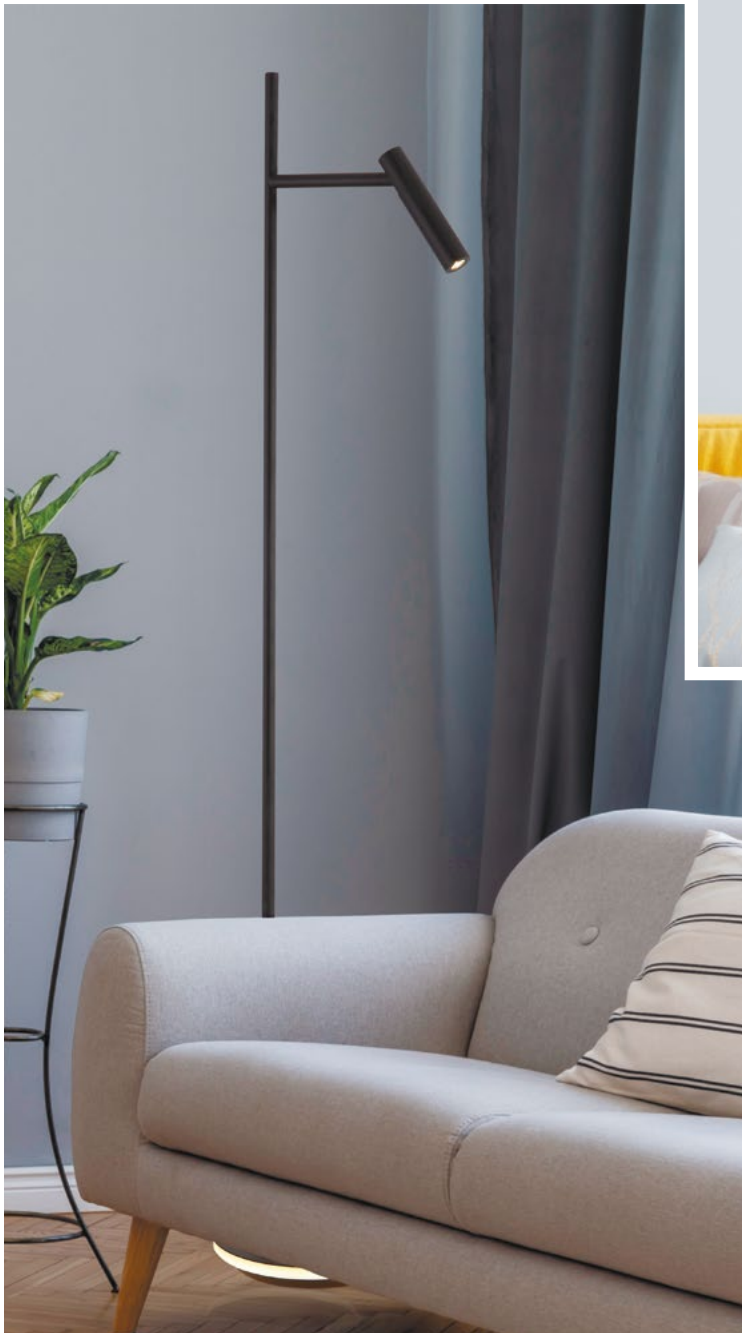



@MAYTONI_OFFICIAL
Follow the latest brand events

TRACK LIGHTING



Track TR003 32



Track TR008 34



Track TR002 33



Track TR004 35



Track TR005 35



Track TRX001 35



Accessories for tracks TRA001CW 36



Accessories for tracks TRA001CF 36



Accessories for tracks TRA001B 36



Accessories for tracks TRA001EC 36



Accessories for tracks TRA001CX 36



Accessories for tracks TRA001CL 36



Accessories for tracks TRA001CT 36



Accessories for tracks TRA001C 36



TR003-1-6W3K-W

DOWNLIGHT



Slim
DL027 62



Yin
DL030 62



Plastic
DL296 63



Atom
DL023 64



Atom
DL024-02 64



Atom
DL024-03 64



Akron
DL025 65



Akron
DL026 65

Atom
DL024-01 64



Atom
DL023 64



Gyps Modern
DL001 67



Gyps Modern
DL002 67



Gyps Modern
DL005 67



Gyps Modern
DL006 67



Metal Modern
DL008 69



Metal Modern
DL009 69



Metal Modern
DL008 69



Metal Modern
DL287 69



Metal Modern
DL290 69



Phanton
DL2001 70



Phanton
DL303 71



Zoom
DL031 73



Zoom
DL033 73

Zoom
DL032 73



Gyps Classic
DL278 293



Gyps Classic
DL279 293



Gyps Classic
DL284 293



Metal Classic
DL301 293



Metal Classic
DL300 293

CEILING LAMP



Line
MOD015 22



Olympia
MOD448 30



Onda
C024 42



Focus
C018 42



Focus
C017 42



Pauline
C007 46



Tube
C019 48



Conik gyps
C001 50



Conik gyps
C002 50



Alfa
C016 52



Alfa
C014 52



Alfa
C012 52



Alfa
C013 53



Elti
C020CL-01W 61



Elti
C021 61



Planet
C009 63



Nastro
MOD446 76



Klee
MOD447 82



Plasma
C444 83



Aprilia
MOD809 84



Crystallize
MOD999 85



Joel
MOD833 87



Balbo
MOD112 92



Ventura
MOD012 96



Dallas
MOD545 109



Bergamo
MOD617 113



Swirl
MOD217 130



Broche
DIA902 134



Dune
DIA005 135



Music 60
MOD362 176



Lulea
C615 179



Halo
C6998 177



Gloria
C6999 178



Lea
ARM369 221



Letizia
ARM365 224



Messina
H223 229

CEILING LAMP



Valencia
H601 231



Zeil
H356 238



Lantana
H300 242



Lamar
H301 244



Palace
DIA890 270



Palace
DIA891 271



Basfor
DIA100 272



Ottilia
DIA700 274



Bella
DIA750 276



Cascade
DIA522 278



Niagara
DIA003 282



Karolina
DIA120 283



Speria
C900 284



Aritos
C906 284



Diametrik
C907 285



Pascal
C908 287



Combinare
C232 286



Gilbert
T532 298



T532CL-08B

PENDANT LAMP



Line
MOD016 23



Satellite
MOD102 24



Nola
MOD101 29



Step
P010 38



Nevill
P318 39



Shelby
P020 40



Ray
P021 41



Plasma
P444 83



Astero
MOD700 86



Manfred
MOD600 89



Delicate
MOD196 90



Balbo
MOD112 93



Avola
MOD431 95



Ventura
MOD012 97



Cloud
MOD003 98



Ring
MOD013 100



Erich
MOD221 104



Dallas
MOD545 109



Dallas
MOD548 108



Tarrasa
MOD009 110



Monic
MOD323 112



Lantern
MOD029 113



Majorca
MOD981 114



Void
MOD030 115



Polly
MOD541 116



Brava Lampada
MOD239 118



Indiana
MOD544 119



Trento
MOD614 120



Novara
MOD619 122



Ellis
MOD200 78

PENDANT LAMP



Empress
DIA002 127



Gletscher
H186 132



Nostalgia
MOD048 107



Cerezo
MOD201 131



Blues
MOD033 139



Puntes
MOD043 126



Plec
P364 140



Telford
P362 140

Tone
P001 142



Iceberg
P012 143



Haze
P244 143



Fermi
P140 145



Dewdrop
P225 146



Walter
P530 148



Elva
P229 149



Daniel
MOD407 150



Eustoma
MOD238 151



Star
MOD246 153



Ball
MOD267 154



Louvre
MOD199 155



Bicones
P359 156



Cup
P019 157



Bellevue
P534 158



Kendal
P111 159



Danas
T162 160



Bergen
T314 160



Moreno
P019 161



Venus
MOD211 80



Ola
P015 162



Irving
T163 163

PENDANT LAMP



Boscage
MOD206 188



Miraggio
MOD602 191



Monsoon
ARM154 197



Olivia
ARM326 198



Grace
ARM247 216



Lea
ARM369 221



Letizia
ARM365 225



Farn
H428 228



Burgeon
ARM959 230



Cipresso
H034 232



Venera
H260 234



Rustika
H899 236



Rappe
H099 240



Anna
H007 250



Bowi
H009 259



Grace
RC247 266



Sherborn
RC015 268



Jackson
T546 296



Spider
T021 299



Delphi
T354 300



Soprano
T432 302



Ginger And Fred
T062 304



Grille
T018 306



Tempo
T164 307



Argo
T268 308



City
T187 309



Monza
T443 306



Denver
T450 310



Gosford
T452 311



Broni
T439 313



Dakota
T455 314



Universal base
SPR-BASE-R 315



Universal base
SPR-BASE 315

CHANDELIER



Erich
MOD221 104



Gelid
MOD184 125



Lincoln
MOD527 111



Alicante
MOD014 182



Bubble Dreams
MOD603 184



Talent
DIA008 136



Talia
MOD334 186



Boscage
MOD206 189



Miraggio
MOD602 191



Intreccio
ARM010 194



Monsoon
ARM154 196



Olivia
ARM326 199



Felicità
ARM029 201



Monile
ARM004 202



Enna
ARM548 204



Lana
ARM143 206



Torino
ARM139 208



Passarinho
ARM001 209



Bird
ARM013 211



Brionia
ARM172 213



Triumph
ARM288 215



Grace
ARM247 216



Filomena
ARM390 219



Bouquet
ARM023 220



Lea
ARM369 221



Vintage
ARM420 223



Perla
ARM337 226



Valencia
H601 231



Zaragoza
H001 246



Bience
H018 256

CHANDELIER



Cable
H357

255

Murano
RC855

262

Vittoria
H004

252

Luxe
H006

249



Chester
RC0100

264

Grace
RC247

266

Sevilla
DIA004

281

Toils
DIA600

128

Lita
H002

260



H002PL-06G

WALL LAMP



Nola
MOD877 28



Ios 176
C176 43



Vilora
C937 44



Pero
C198 45



Stem
C035 46



Hill
C608 49



Toni
C177 54



Everett
C815 55



Rack
C182 48



Parma
C155 57



Parma
C191 57



Trame
C804 59



Trame
C806 59



Trame
C808 59



Gyps Modern
DL011 66



Nastro
MOD446 77



Manfred
MOD600 89



Avola
MOD431 94



Ventura
MOD012 96



Erich
MOD221 104



Dallas
MOD547 108



Gelid
MOD184 125



Tarrasa
MOD009 110



Lincoln
MOD527 111



Indiana
MOD544 119



Puntes
MOD043 126



Domino
MOD142 121



Karl
MOD618 123



Nostalgia
MOD048 106



Talento
DIA008 136

WALL LAMP



Finelli
MIR004 174



Blues
MOD033 139



Daniel
MOD407 150



Irving
T163 163



Fino
MIR003 172



Lao
MIR002 173



Gleam
MIR005 175



Alicante
MOD014 182



Bubble Dreams
MOD603 184



Talia
MOD334 186



Boscage
MOD206 188



Miraggio
MOD602 191



Intreccio
ARM010 194



Monsoon
ARM154 196



Olivia
ARM326 198



Felicita
ARM029 201



Monile
ARM004 202



Enna
ARM548 204



Lana
ARM143 206



Torino
ARM139 208



Passarinho
ARM001 209



Bird
ARM013 210



Brionia
ARM172 213



Triumph
ARM288 215



Grace
ARM247 216



Filomena
ARM390 218



Bouquet
ARM023 220



Lea
ARM369 221



Vintage
ARM420 222



Letizia
ARM365 224



Perla
ARM337 226



Farn
H428 228



Messina
H223 229

WALL LAMP



Luxe
H006

248



Burgeon
ARM959 230



Cipresso
H034 232



Venera
H260 234



Rustika
H899 236



Lamar
H301 244



Zaragoza
H001 246



Lita
H002 260



Anna
H007 250



Vittoria
H005 252



Cable
H357 254



Bience
H018 257



Murano
RC855 262



Chester
RC0100 264



Grace
RC247 266



Palace
DIA890 271



Basfor
DIA100 273



Ottilia
DIA700 275



Bella
DIA750 276



Cascade
DIA522 278



Sevilla
DIA004 281



Rubens
PIC117 290



Renoir
PIC118 290



Raphael
PIC113 291



Picasso
PIC114 291



Giovanni
PIC119 292



Toils
DIA600 128



Gilbert
T532 300



Delphi
T354 300



Tempo
T164 307

TABLE AND FLOOR LAMP

									
Erich MOD221	104	Nola MOD877	28	Nastro MOD446	76	Delicate MOD196	90	Avola MOD431	94
									
Tarrasa MOD009	110	Monic MOD323	112						
									
Lantern MOD029	113	Polly MOD542	116	Indiana MOD544	119	Trento MOD614	120	Talento DIA008	136
									
Novara MOD611	122	Karl MOD618	123	Ellis MOD200	78	Domino MOD142	121		
									
Nashorn MOD470	164	Estudo Z010	171	Zeppo 137 Z137	166	Alicante MOD014	182		
Pixar Z148	165	Apex Z147	167	Calvin Z177	168	Farel Z001	169		

TABLE AND FLOOR LAMP



Maryland
ARM526

192



Nevada
Z329

170



Bubble Dreams
MOD603

185



Miraggio
MOD602

191



Intreccio
ARM010

194



Olivia
ARM326

198



Felicita
ARM029

201



Monile
ARM004

202-203



Enna
ARM548

205



Grace
ARM247

217



Bird
ARM013



210-211



Brionia
ARM172

213



Filomena
ARM390

218



Vintage
ARM420

222



Farn
H428

228



Senna
H353

239



Luxe
H006

248



Murano
ARM855

262



Zaragoza
H001

246



Bience
H018

257



Chester
RC0100

264



Grace
RC247

266-267



Montana
H351

288



Kiwi
Z153

289

OUTDOOR



Times Square
O594 318
O580-O581 319



Fulton
O572-O573 320



Wolseley Road
O011 322



Madison Avenue
O583-O584 323



Gansevoort
O575 324



Broadway
O803 325



Wall Street
O010



Beekman
O802 326



Bowery
O574 327



Bronx
O576 327



La Rambla
S104 333



Unter den Linden
O578 330



Champs Elysees
S110 335



Oxford
S101 336-337



S105-106-41-G

MARKS & SYMBOLS

 QUANTITY AND TYPE OF BULB

H HEIGHT

W WIDTH

L LENGHT

D DIAMETER

Hmin, Hmax

 d1 LAMPSHADE TOP DIAMETER

 d2 LAMPSHADE BOTTOM DIAMETER

 h LAMPSHADE HEIGHT

 BASE SWITCH

 IN-LINE SWITCH

 LED LED FIXTURE

 K CCT

 PAINTABLE

 CHANDELIERS, PENDANTS

 CEILING LIGHTS

 WALL LIGHTS

 TABLE LAMPS, FLOOR LAMPS



Technical
Track
Pendant
Ceiling & Wall
Downlight

MAYTONI TECHNICAL

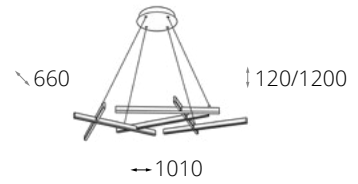

MOD016PL-L75B

LED 75W

H min: 120, H max: 1200,
W: 1010, L: 660 mm,
2600 Lumen, 3000 K, 80 RA,
120 °, 220-240 V, IP20

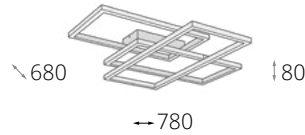
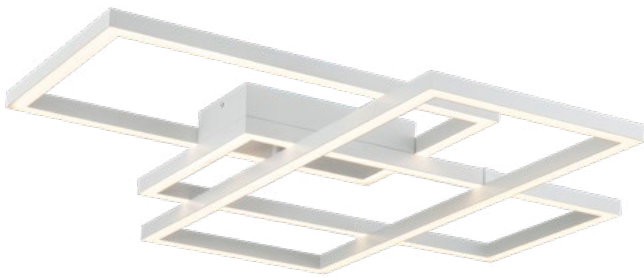

MOD015CL-L80W

LED 80W

H: 80, W: 780, L: 680 mm,
4100 Lumen, 3000 K, 80 RA,
120 °, 220-240 V, IP20

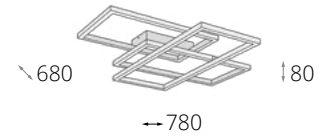
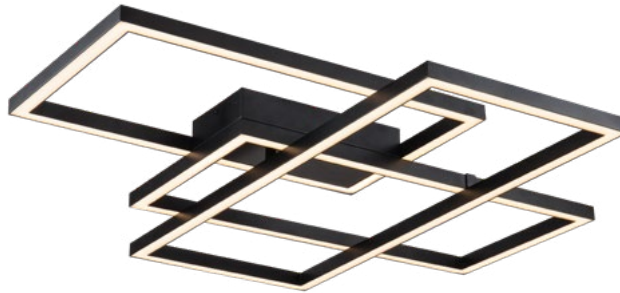

MOD015CL-L80B

LED 80W

H: 80, W: 780, L: 680 mm,
3900 Lumen, 3000 K, 80 RA,
120 °, 220-240 V, IP20

LINE

en Metal frame, integrated LED module. Acrylic diffuser. **de** Metallrahmen, integriertes LED Modul. Diffusor aus Acryl.
fr Armature métallique, module LED intégré. Diffuseur acrylique. **it** Struttura in metallo, modulo LED integrato.
Diffusore in acrilico. **es** Estructura metálica, módulo LED integrado. Difusor acrílico. **pl** Metalowe obramowanie,
zintegrowany moduł LED. Dyfuzor akrylowy. **ru** Арматура из металла, встроенный LED-модуль. Плафон из акрила.



○ White / W

● Black / B



▲
MOD016PL-L75W
LED 75W
H min: 120, H max: 1200,
W: 1010, L: 660 mm,
2600 Lumen, 3000 K, 80 RA,
120 °, 220-240 V, IP20





▲
MOD102PL-L42W
 LED 42W
 H min: 330, H max: 1200,
 W: 900, L: 980 mm,
 3800 Lumen, 3000 K, 80 RA,
 24 °, 220-240 V, IP20

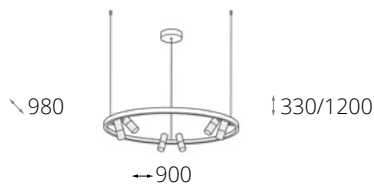

◀ **MOD102PL-L42B**
 LED 42W
 H min: 330, H max: 1200,
 W: 900, L: 980 mm,
 3800 Lumen, 3000 K, 80 RA,
 24 °, 220-240 V, IP20

SATELLITE

en Metal frame with pivoting spots: horizontally 340° and vertically 90°. Integrated LED module. **de** Metallrahmen mit schwenkbaren Spots: horizontal 340° und vertikal 90°. Integriertes LED Modul. **fr** Armature métallique avec spots pivotants: horizontalement 340° et verticalement 90°. Module LED intégré. **it** Struttura in metallo con spot regolabili in orizzontale (340°) e in verticale (90°). Modulo LED integrato. **es** Estructura metálica con giro horizontal de 340 ° y vertical de 90 °. Módulo LED integrado. Marco metálico con módulo LED integrado. **pl** Metalowe obramowanie ze spotami obrotowymi: poziomo 340° i pionowo 90°. Zintegrowany moduł LED. **ru** Арматура из металла. Споты с LED-модулями зафиксированы на кольце и регулируются в двух плоскостях: 340° (по горизонтали) и 90° (по вертикали).



○ White / W

● Black / B

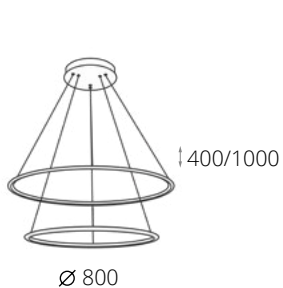

▲
MOD877PL-L85W
 LED 85W
 H min: 400, H max: 1000,
 D: 800 mm, 4800 Lumen, 3000 K,
 80 RA, 120 °, 220-240 V, IP20

NOLA

en Metal frame with ring elements and integrated LED. **de** Metallrahmen mit Ringelementen und integriertes LED.
fr Armature métallique avec anneaux LED intégré. **it** Struttura in metallo con elementi ad anello e LED integrati.
es Estructura metálica con aros y LED integrado. **pl** Metalowe obramowanie w kształcie pierścieni i zintegrowany moduł LED. **ru** Арматура из металла в виде колец. Встроенный LED-модуль.



○ White / W

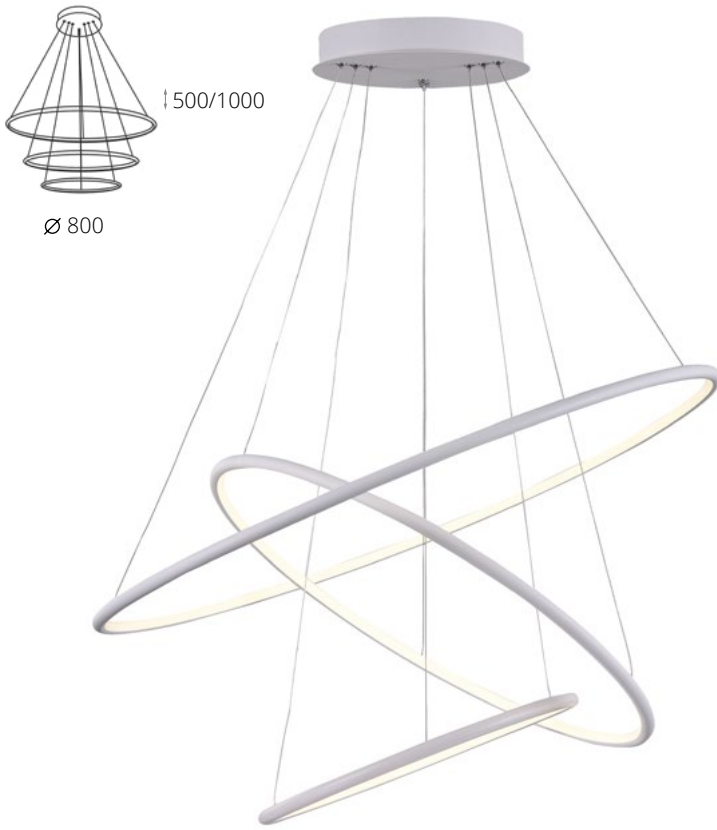

▲
MOD877PL-L110W
 LED 110W
 H min: 500, H max: 1000,
 D: 800 mm, 5500 Lumen, 3000 K,
 80 RA, 120 °, 220-240 V, IP20

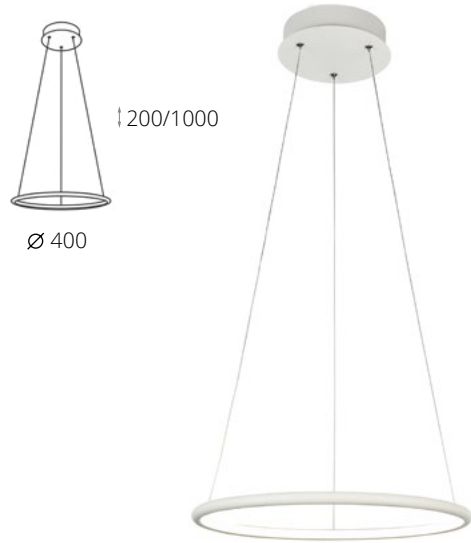

▲
MOD877PL-L24W
 LED 24W
 H min: 200, H max: 1000,
 D: 400 mm, 1400 Lumen, 3000 K,
 80 RA, 120 °, 220-240 V, IP20

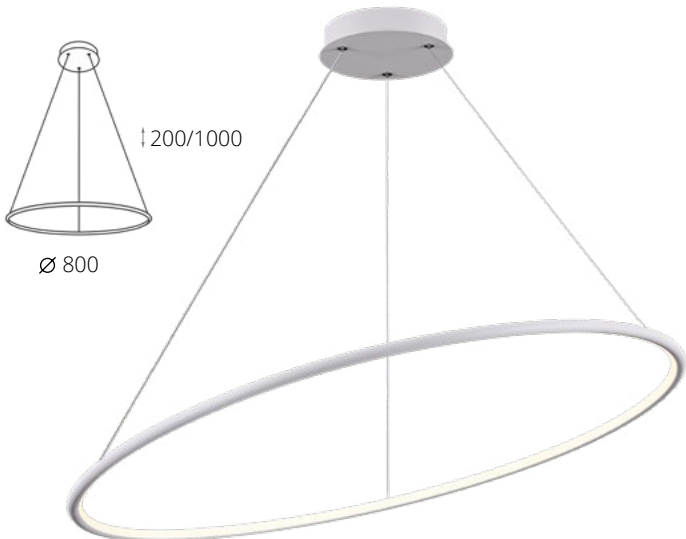

▲
MOD877PL-L48W
 LED 48W
 H min: 200, H max: 1000,
 D: 800 mm, 2900 Lumen, 3000 K,
 80 RA, 120 °, 220-240 V, IP20



▲
MOD877PL-L36W
 LED 36W
 H min: 200, H max: 1000,
 D: 600 mm, 2300 Lumen, 3000 K,
 80 RA, 120 °, 220-240 V, IP20

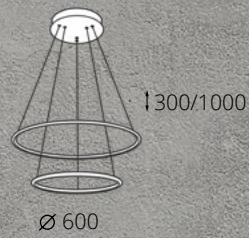

▲
MOD877PL-L62W
LED 60W
H min: 300, H max: 1000,
D: 600 mm, 3300 Lumen, 3000 K,
80 RA, 120 °, 220-240 V, IP20



▲
MOD877WL-L12W
 ☞ LED 12W
 H: 200, W: 48, L: 200 mm,
 800 Lumen, 3000 K, 80 RA,
 120 °, 220-240 V, IP20

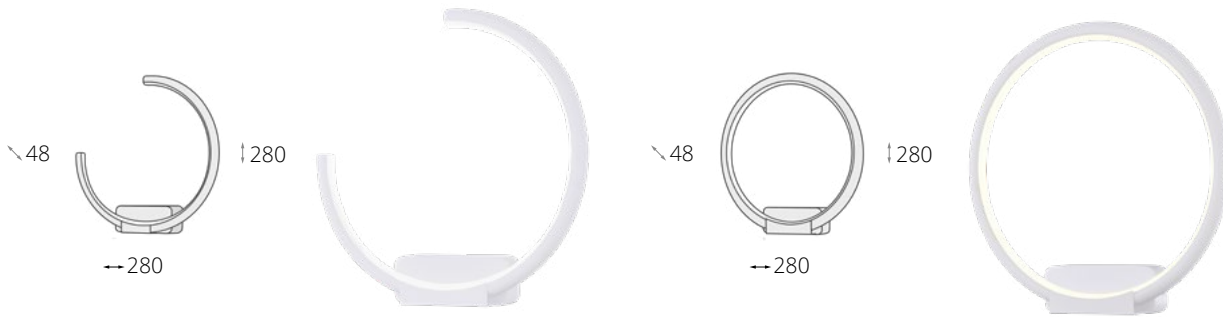

▲
MOD877WL-L13W
 ☞ LED 13W
 H: 280, W: 280, L: 48 mm,
 800 Lumen, 3000 K, 80 RA,
 120 °, 220-240 V, IP20

▲
MOD877WL-L18W
 ☞ LED 18W
 H: 280, W: 48, L: 280 mm,
 1000 Lumen, 3000 K, 80 RA,
 120 °, 220-240 V, IP20

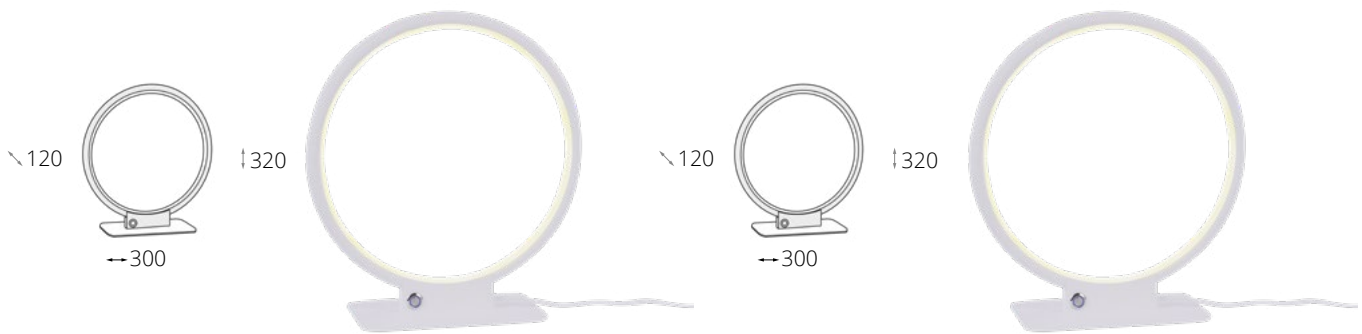

▲
MOD877TL-L18W
 ☞ LED 18W
 H: 320, W: 300, L: 120 mm,
 900 Lumen, 3000 K, 80 RA,
 120 °, 220-240 V, IP20,
 Class 2, Dimmable

▲
MOD807TL-L18W
 ☞ LED 18W
 H: 320, W: 300, L: 120 mm,
 900 Lumen, 4100 K, 80 RA,
 120 °, 220-240 V, IP20,
 Class 2

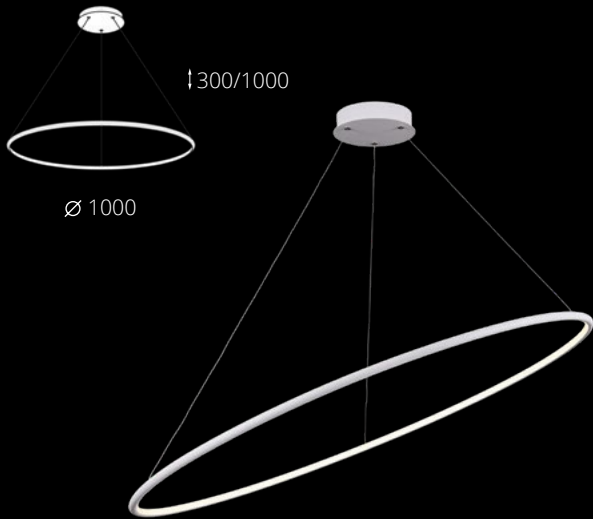

▲
MOD877PL-L60W
 LED 60W
 H min: 300, H max: 1000,
 D: 1000 mm, 3800 Lumen, 3000 K,
 80 RA, 120 °, 220-240 V, IP20

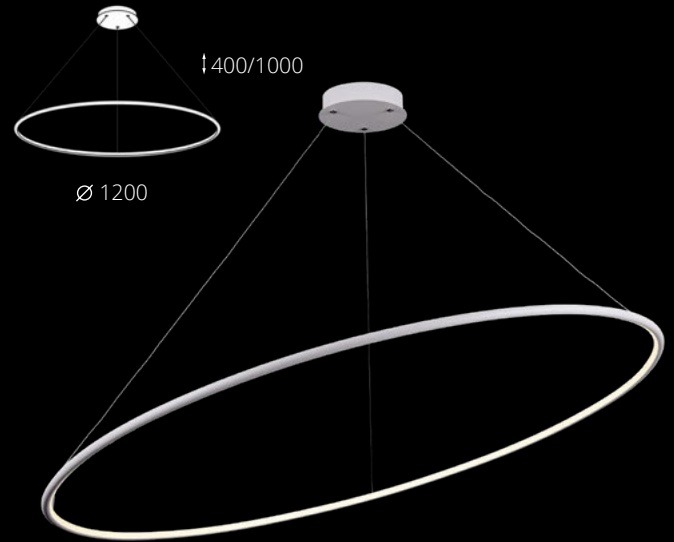

▲
MOD877PL-L70W
 LED 70W
 H min: 400, H max: 1000,
 D: 1200 mm, 4200 Lumen, 3000 K,
 80 RA, 120 °, 220-240 V, IP20

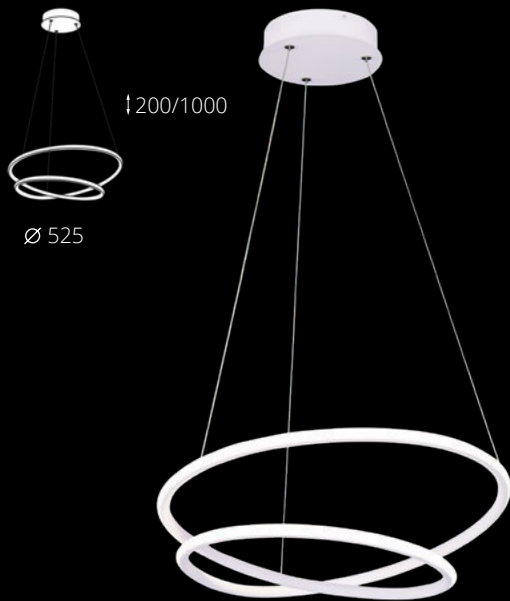

▲
MOD101PL-L47W
 LED 47W
 H min: 200, H max: 1000,
 D: 525 mm, 3000 Lumen, 3000 K,
 > 80 RA, 120 °, 220-240 V, IP20

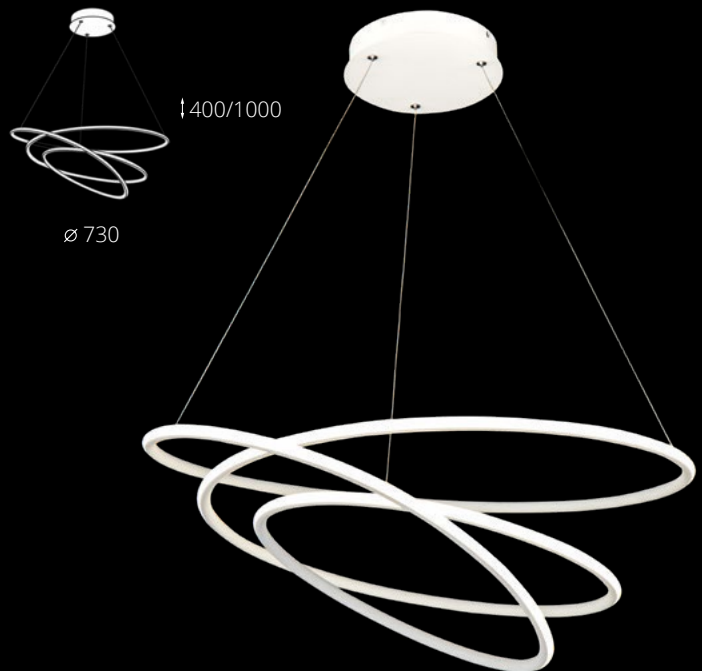

▲
MOD101PL-L88W
 LED 88W
 H min: 400, H max: 1000,
 D: 730 mm, 6900 Lumen, 3000 K,
 > 80 RA, 120 °, 220-240 V, IP20



MOD448-CL-4-30-W

LED 30W

H: 70, W: 740, L: 440 mm,
1500 Lumen, 3000 K, 80 RA,
120 °, 220-240 V, IP20

OLYMPIA

en Metal frame with integrated LED module. **de** Metallrahmen mit integriertem LED Modul. **fr** Armature métallique avec module LED intégré. **it** Struttura in metallo con modulo LED integrato. **es** Estructura metálica con módulo LED integrado. **pl** Metalowe obramowanie z wbudowanym modulem LED. **ru** Арматура из металла. Современный дизайн с использованием LED-модуля.



LED

3000K



White / W



Nickel / N

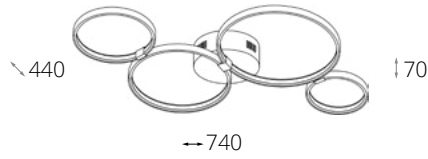

▲
MOD448-44-N
 LED 30W
 H: 70, W: 740, L: 440 mm,
 1500 Lumen, 3000 K, 80 RA,
 120 °, 220-240 V, IP20

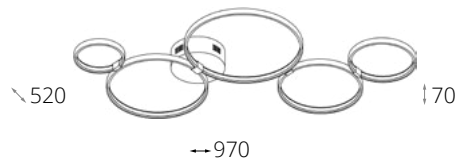

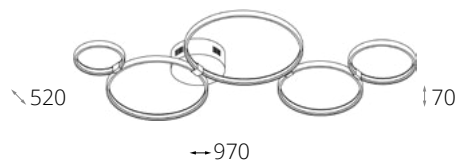

▲
MOD448-55-N
 LED 45W
 H: 70, W: 970, L: 520 mm,
 2000 Lumen, 3000 K, 80 RA,
 120 °, 220-240 V, IP20,
 Class 2

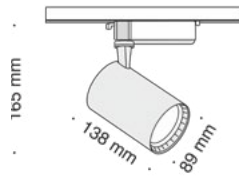

▲
MOD448-CL-5-45-W
 LED 45W
 H: 70, W: 970, L: 520 mm,
 2250 Lumen, 3000 K, 80 RA,
 120 °, 220-240 V, IP20

	Article	Luminous flux	CCT	RA	Beam angle	Input voltage	IP
 LED 17W H: 165, W: 89, L: 138 mm, Class 2	TR003-1-17W4K-B	1150 LM	4000 K	80	24 °	220-240 V	20
	TR003-1-17W4K-W	1300 LM	4000 K	80	24 °	220-240 V	20



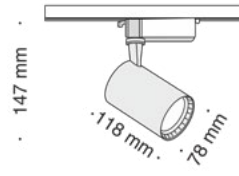

 LED 12W
 H: 147, W: 78, L: 118 mm,
 Class 2

TR003-1-12W4K-B	800 LM	4000 K	80	24 °	220-240 V	20
TR003-1-12W4K-W	800 LM	4000 K	80	24 °	220-240 V	20



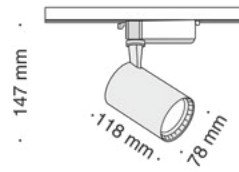

 LED 12W
 H: 147, W: 78, L: 118 mm,
 Class 2

TR003-1-12W3K-B	750 LM	3000 K	80	24 °	220-240 V	20
TR003-1-12W3K-W	750 LM	3000 K	80	24 °	220-240 V	20

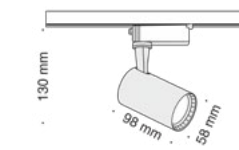

 LED 6W
 H: 130, W: 58, L: 98 mm,
 Class 2

TR003-1-6W3K-B	450 LM	3000 K	80	24 °	220-240 V	20
TR003-1-6W3K-W	450 LM	3000 K	80	24 °	220-240 V	20



TRACK

en Extruded aluminum tracklight. White or black powder coating. Adjustable 355°. **de** Tracklight aus extrudiertem Aluminium. Weiße oder schwarze Pulverbeschichtung. 355° verstellbar. **fr** Projecteur en aluminium extrudé. Revêtement en poudre blanc ou noir. Réglable à 355°. **it** Proiettore in alluminio estruso. Verniciatura a polvere bianca o nera. Regolabile a 355°. **es** Proyector de aluminio extruido. Metalizado en blanco o negro. Ajustable 355°. **pl** Wytłaczany aluminiowy reflektor. Biała lub czarna powłoka proszkowa. Możliwość regulacji 355°. **ru** Трековый светильник из алюминия. Модель представлена в белом или черном цвете. Регулировка направления светового потока 355°.



○ White / W

● Black / B



▲
TR002-1-GU10-B/W
☞ 1xGU10 50W
H: 179, W: 54, L: 100 mm,
Class 2

	Article	Luminous flux	CCT	RA	Beam angle	Input voltage	IP
 LED 30W H: 165, W: 89, L: 138 mm, Class 2, Dimmable	TR003-1-30W3K-B	2400 LM	3000 K	80	24 °	170-240 V	20
	TR003-1-30W3K-W	2400 LM	3000 K	80	24 °	170-240 V	20

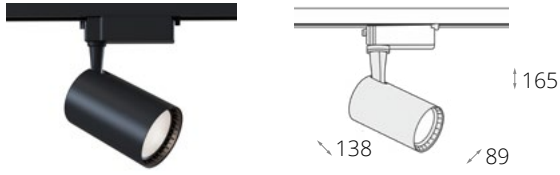

 LED 30W H: 165, W: 89, L: 138 mm, Class 2, Dimmable	TR003-1-30W4K-B	2400 LM	4000 K	80	24 °	170-240 V	20
	TR003-1-30W4K-W	2400 LM	4000 K	80	24 °	170-240 V	20



 LED 17W H: 165, W: 89, L: 138 mm, Class 2, Dimmable	TR003-1-17W3K-B	950 LM	3000 K	80	24 °	220-240 V	20
	TR003-1-17W3K-W	1050 LM	3000 K	80	24 °	220-240 V	20

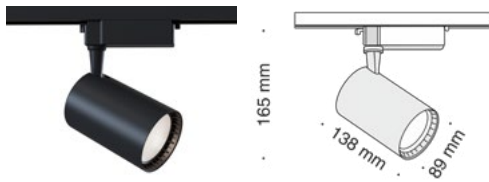

 LED 6W H: 130, W: 58, L: 98 mm, Class 2, Dimmable	TR003-1-6W4K-B	480 LM	4000 K	80	24 °	220-240 V	20
	TR003-1-6W4K-W	480 LM	4000 K	80	24 °	220-240 V	20

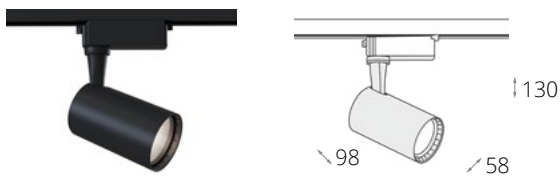

	Article	Input voltage	IP
 1xGU10 50W H min: 400, H max: 1800, D: 60 mm, Class 2	TR008-1-GU10-W	220-240 V	20
	TR008-1-GU10-B	220-240 V	20

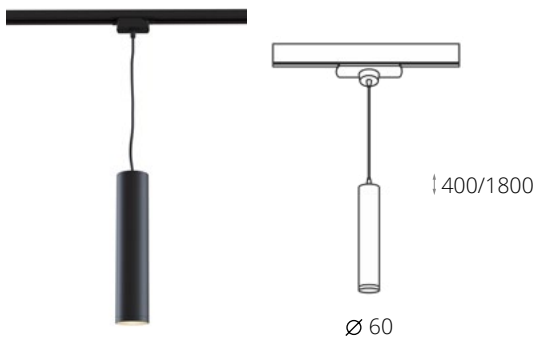

	Article	Input voltage	IP
<p>1xGU10 50W H: 179, W: 54, L: 100 mm, Class 2</p> 	TR002-1-GU10-W	220-240 V	20
	TR002-1-GU10-B	220-240 V	20
<p>1xGU10 50W H: 210, W: 60, L: 130 mm, Class 2</p> 	TR004-1-GU10-B	220-240 V	20
	TR004-1-GU10-W	220-240 V	20
<p>1xGU10 50W H min: 203, H max: 280, W: 200, L: 53 mm, Class 2</p> 	TR005-1-GU10-B	220-240 V	20
	TR005-1-GU10-W	220-240 V	20
<p>H: 20, W: 33, L: 1000 mm</p> 	TRX001-111W	-	20
	TRX001-111B	-	20
<p>H: 20, W: 33, L: 2000 mm</p> 	TRX001-112W	-	20
	TRX001-112B	-	20



▲
TRA001CW-11B/W
H: 32, W: 32 L: 2000 mm



▲
TRA001CF-11B/W
H: 20, W: 35, L: 280 mm



▲
TRA001B-11B/W
H: 22, W: 38, L: 112 mm



▲
TRA001EC-11B/W
H: 23, W: 23, L: 38 mm



▲
TRA001CX-11B/W
H: 23, W: 110, L: 110 mm



▲
TRA001CL-11B/W
H: 17, W: 70, L: 70 mm



▲
TRA001CT-11B/W
H: 17, W: 70, L: 106 mm



▲
TRA001C-11B/W
H: 20, W: 33, L: 71 mm

ACCESSORIES FOR TRACKS

en Accessories for Maytoni's track lights. **de** Zubehör für Maytonis Tracklights. **fr** Accessoires pour les projecteurs sur rails de Maytoni. **it** Accessori per binari Maytoni. **es** Accesorios para carriles de Maytoni. **pl** Akcesoria do reflektorów szynowych Maytoni. **ru** Аксессуары для трековых светильников Maytoni.

○ White / W

● Black / B



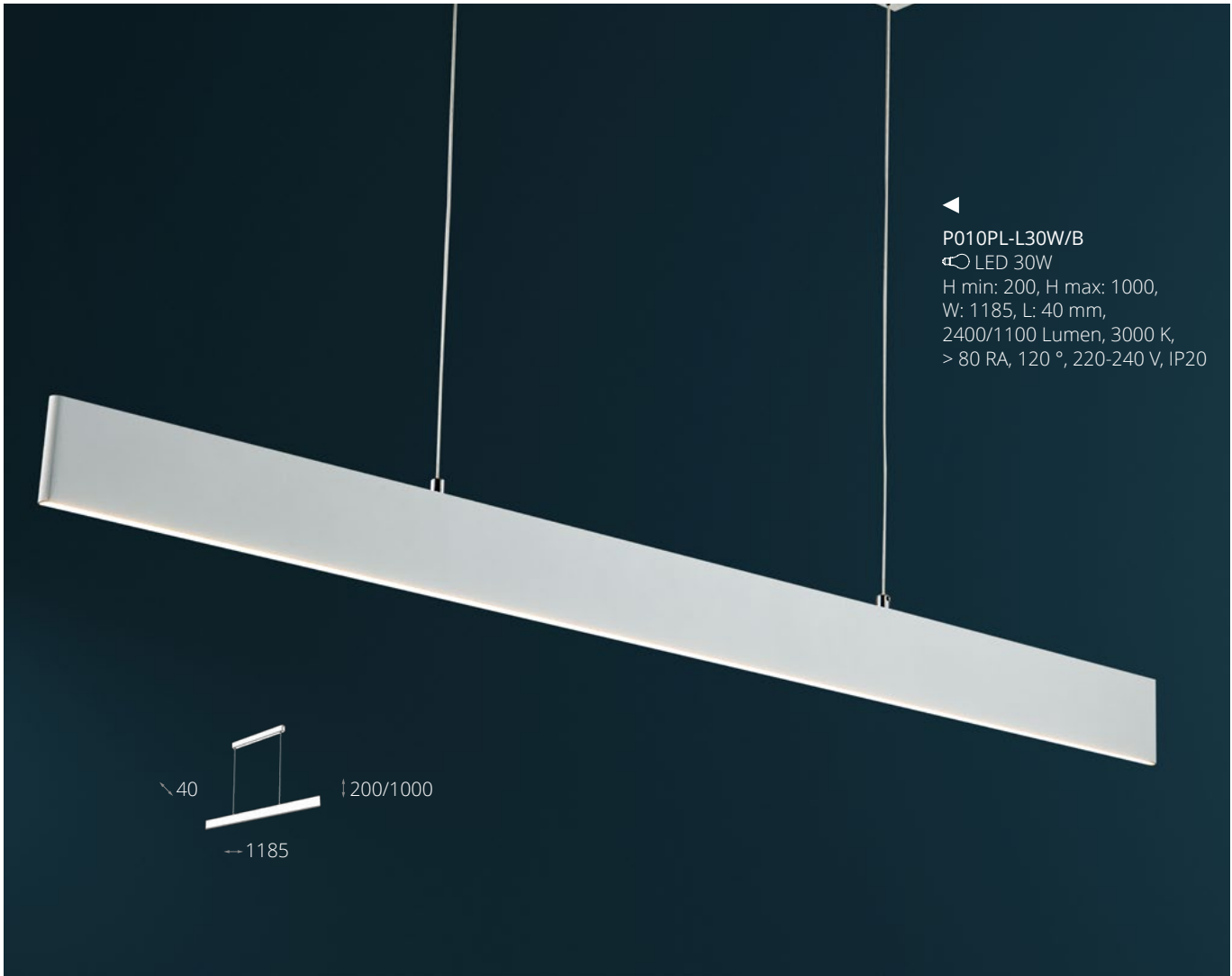

P010PL-L30W/B
 LED 30W
 H min: 200, H max: 1000,
 W: 1185, L: 40 mm,
 2400/1100 Lumen, 3000 K,
 > 80 RA, 120 °, 220-240 V, IP20

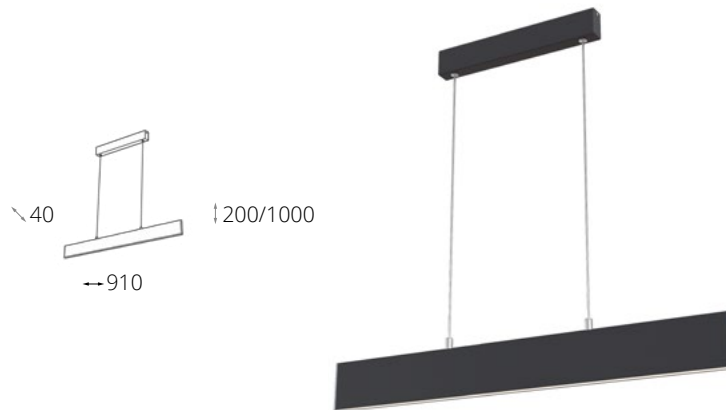

P010PL-L23B/W
 LED 23W
 H min: 200, H max: 1000,
 W: 910, L: 40 mm,
 900/1900 Lumen, 3000 K,
 > 80 RA, 120 °, 220-240 V, IP20

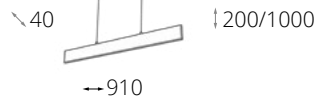

STEP

en Metal frame with integrated LED module. Direct and indirect light. **de** Metallrahmen mit integriertem LED Modul. Direktes und indirektes Licht. **fr** Armature métallique, module LED intégré. Lumière directe et indirecte. **it** Struttura in metallo con modulo LED integrato. Luce diretta e indiretta. **es** Estructura metálica con módulo LED integrado. Luz directa e indirecta. **pl** Metalowe obramowanie, zintegrowany moduł LED. Światło bezpośrednie i pośrednie. **ru** Арматура из металла. LED-модуль. Свечение Up&Down.



○ White / W

● Black / B

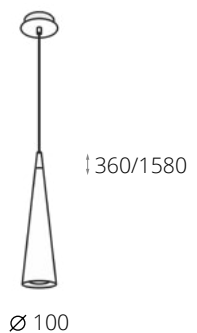

P318PL-01B/W/N
 1xGU10 50W
 H min: 360, H max: 1580,
 D: 100 mm,
 □ d1=18 / d2=80 / h=300,
 220-240 V, IP20

NEVILL

en Metal ceiling cup and body. Adjustable height. Available in 3 finishes. **de** Deckenbaldachin und Korpus aus Metall. Höhenverstellbar. Erhältlich in 3 Ausführungen. **fr** Coupelle et corps en métal. Hauteur réglable. Disponible en 3 finitions. **it** Calotta da soffitto e corpo in metallo. Altezza regolabile. Disponibile in 3 finiture. **es** Estructura de metal. Altura ajustable. Disponible en 3 acabados. **pl** Metalowa puszka sufitowa i obudowa. Regulowana wysokość. Dostępna w 3 wykończeniach. **ru** Каркас и плафон выполнены из металла. Регулируемая длина светильников. Модель представлена в 3-х цветах.



○ White / W

● Black / B

● Nickel / N



SHELBY

en Aluminium base and body. Available in 3 finishes. Adjustable height. **de** Basis und Korpus aus Aluminium. Verstellbar. Erhältlich in 3 Ausführungen. Höhenverstellbar. **fr** Base et corps en aluminium. Hauteur ajustable. **it** Base e corpo in alluminio. Disponibile in 3 finiture. Altezza regolabile. **es** Base y cuerpo de aluminio. Ajustable. Disponible en 3 acabados. Altura ajustable. **pl** Aluminiowa podstawa i obudowa. Dostępna w 3 wykończeniach. Regulowana wysokość. **ru** Основание и корпус выполнены из алюминия. Модель представлена в 3-х цветах. Регулируемая длина светильников.



○ White / W

● Black / B

○ Silver / S



RAY

en Metal frame. Adjustable height of lamps. LED module. **de** Metallrahmen. Einstellbare Höhe der Lampen. Modul LED. **fr** Armature en métal. Hauteur ajustable. Module LED. **it** Struttura in metallo. Altezza regolabile. Modulo LED. **es** Estructura de metal. Altura variable. Módulo LED. **pl** Metalowe obramowanie. Regulowana wysokość. Moduł LED. **ru** Арматура из металла. Регулируемая высота светильников. LED-модуль.



○ White / W

● Black / B



C017CW-01W
 1xGU10 50W
 H: 195, D: 65 mm,
 □ d=60 / h=130,
 220-240 V, IP20,
 Class 2

C018CL-01W
 1xGU10 50W
 H: 192, D: 60 mm,
 □ d=60 / h=300,
 220-240 V, IP20,
 Class 2

FOCUS

en Powder coated aluminium body. Adjustable 180° horizontal- 90° vertical. **de** Pulverbeschichteter Korpus aus Aluminium. Horizontal um 180° und vertikal um 90° verstellbar. **fr** Corps en aluminium enduit de poudre. Réglable à 180 ° horizontalement - 90 ° verticalement. **it** Corpo in alluminio verniciato a polvere. Orientabile a 180 ° in orizzontale e a 90° in verticale. **es** Estructura de aluminio metalizado. Ajustable 180 ° horizontal - 90 ° vertical. **pl** Aluminiowa obudowa malowana proszkowo, możliwość regulacji 180° w poziomie i 90° w pionie. **ru** Корпус из алюминия с порошковым окрашиванием. Регулировка направления светового потока в двух плоскостях: 180° (по горизонтали) и 90° (по вертикали).



○ White / W



C024CL-L18W
 LED 18W
 H: 82, D: 120 mm,
 1400 Lumen, 3000 K, > 80 RA,
 120 °, 220-240 V, IP20

C024CL-L18B
 LED 18W
 H: 82, D: 120 mm,
 1000 Lumen, 3000 K, > 80 RA,
 120 °, 220-240 V, IP20

ONDA

en Surface-mounted ceiling lamp. Metal frame consists of a static base and a rotating part. Adjustment of the position horizontally (355°), vertically (90°). LED module. **de** Deckenaufbauleuchte. Metallrahmen besteht aus einer statischen Basis und einem drehbaren Teil. Einstellung der Position horizontal (355 °), vertikal (90 °). Modul LED. **fr** Lampe à fixer au plafond. Armature en métal constituée d'une partie en métal et d'une partie amovible. Réglage de la direction du flux lumineux horizontalement (355°), verticalement (90 °). **it** Plafoniera da parete. Struttura in metallo costituita da una base statica e da una parte rotante. Regolazione della posizione in orizzontale (355°) e in verticale (90°). Modulo LED. **es** Plafón de techo y de pared. Estructura de metal con fundación estático y el parte rotatorio. La dirección ajustada de corriente de luz de horizontal (355°), y vertical (90°). Modulo LED. **pl** Lampa sufitowa natynkowa. Metalowa rama składa się z podstawy statycznej i części obrotowej. Regulacja pozycji w poziomie (355°), w pionie (90°). Moduł LED. **ru** Накладной потолочный светильник. Корпус из металла состоит из статического основания и поворотной части. Регулировка положения по горизонтали (355°), по вертикали (90°). LED-модуль.



○ White / W ● Black / B



IOS 176

en Metal frame, LED module. Adjustable spot. Direct and indirect light. **de** Metallrahmen, LED Modul. Einstellbarer Spot. Direktes und indirektes Licht. **fr** Support en métal, module LED. Spot réglable. Lumière directe et indirecte. **it** Struttura in metallo, modulo LED. Spot regolabile. Luce diretta e indiretta. **es** Estructura metálica, módulo LED. Punto ajustable. Luz directa e indirecta. **pl** Metalowe obramowanie, moduł LED. Regulowany spot. Światło bezpośrednie i pośrednie. **ru** Арматура из металла. LED-модуль. Регулировка направления спота. Свечение Up&Down.



White / W Black / B

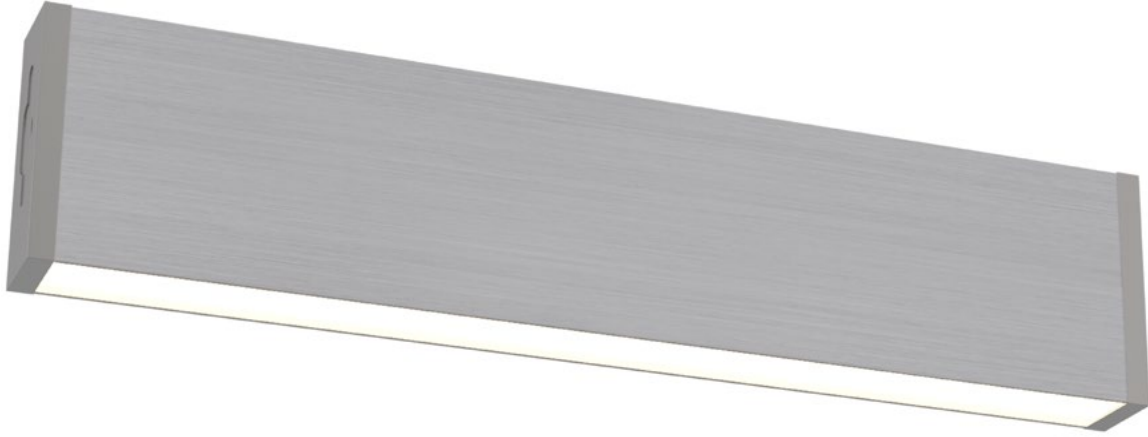

▲
C937-WL-01-18W-N
LED 18W
H: 70, W: 602, L: 50 mm,
1720 Lumen, 4000 K, 80 RA,
120 °, 220-240 V, IP20



▼
C937-WL-01-12W-N
LED 12W
H: 70, W: 316, L: 50 mm,
850 Lumen, 4000 K, 80 RA,
120 °, 220-240 V, IP20



VILORA

en Brushed aluminum frame, LED module. **de** Gebürsteter Rahmen aus Aluminium, LED Modul.
fr Support en aluminium brossé, module LED. **it** Struttura in alluminio spazzolato, modulo LED.
es Estructura de aluminio cepillado, módulo LED. **pl** Szczotkowana rama aluminiowa, moduł LED.
ru Арматура из полированного алюминия. LED-модуль.



● Grey / GR

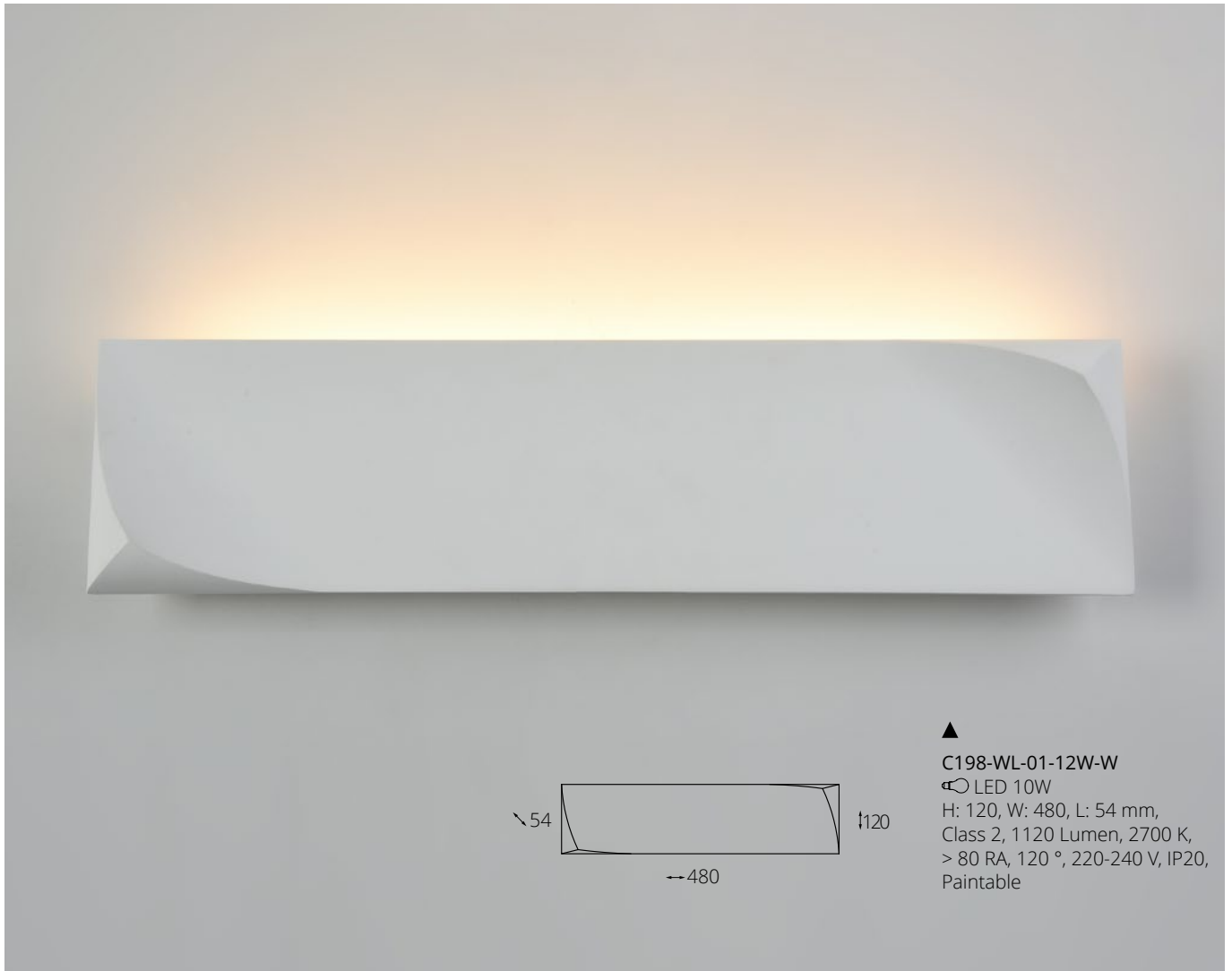

C198-WL-01-12W-W

LED 10W

H: 120, W: 480, L: 54 mm,
Class 2, 1120 Lumen, 2700 K,
> 80 RA, 120 °, 220-240 V, IP20,
Paintable

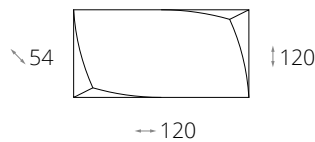

C198-WL-01-6W-W

LED 6W

H: 120, W: 240, L: 54 mm,
560 Lumen, 2700 K, > 80 RA,
120 °, 220-240 V, IP20
Class 2, Paintable

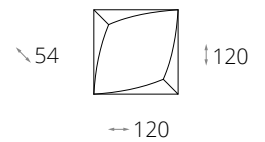

C198-WL-01-3W-W

LED 3W

H: 120, W: 120, L: 54 mm,
280 Lumen, 2700 K, > 80 RA,
120 °, 220-240 V, IP20
Class 2, Paintable

PERO

en Wall lamp. White plaster body. Paintable. **de** Individuell gestaltbare Wandleuchte mit weißem Gipskörper zum anmalen. **fr** Applique murale. Corps en plâtre blanc. Peut être peint. **it** Lampada da parete in gesso bianco. Verniciabile. **es** Applique de pared. Cuerpo de yeso blanco. Puede pintarse. **pl** Lampa ścienna. Obudowa o wyglądzie białego tynku. Możliwość malowania. **ru** Настенный светильник. Корпус из белого гипса. Возможность окрашивания.



○ White / W



◀
C007CW-01W
 ⚡ 1xGU10 50W
 H: 131, D: 64 mm,
 □ d=64 / h=44,
 220-240 V, IP20



◀
C007CW-01B
 ⚡ 1xGU10 50W
 H: 131, D: 64 mm,
 □ d=64 / h=44,
 220-240 V, IP20

PAULINE

en Ceiling lamp. Frame made of aluminium and acrylic. **de** Deckenleuchte. Rahmen aus Aluminium und Acryl. **fr** Plafonnier. Cadre en aluminium et acrylique. **it** Lampada da soffitto. Struttura in alluminio e acrilico. **es** Plafón de techo. Carcasa de aluminio y acrílico. **pl** Lampa sufitowa. Rama wykonana z aluminium i akrylu. **ru** Потолочный светильник. Корпус из алюминия и акрила.



○ White / W

● Black / B

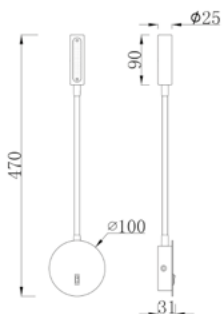

◀
C035WL-L3W3K
 ⚡ LED 3W
 H: 470, W: 31, L: 100 mm,
 150 Lumen, 3000 K, 80 RA,
 120 °, 220-240 V, IP20,
 Class 2,

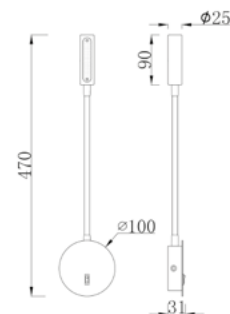

◀
C035WL-L3B3K
 ⚡ LED 3W
 H: 470, W: 31, L: 100 mm,
 150 Lumen, 3000 K, 80 RA,
 120 °, 220-240 V, IP20,
 Class 2,

STEM

en Metal frame. Model is available in various colours. Adjustable. LED module. **de** Metallrahmen. Modell ist in verschiedenen Farben erhältlich. Eine flexible Halterung erleichtert das Ändern des Neigungswinkels und der Lichtrichtung. Led Modul. **fr** Armature en métal. Modèle disponible en plusieurs couleurs. Un support flexible permet de changer facilement l'angle d'inclinaison et la direction de la lumière. Module LED. **it** Corpo luce in metallo, orientabile. Disponibile in diverse finiture. Modulo Led. **es** Estructura de metal. El modelo se presenta en varios colores. Gracias al trípode flexible, puede cambiar fácilmente el ángulo y la dirección de la luz. Módulo LED. **pl** Metalowe obramowanie. Model jest dostępny w różnych kolorach, z możliwością regulacji. Moduł LED. **ru** Арматура из металла. Модель представлена в нескольких цветах. Благодаря гибкому штативу можно легко менять угол наклона и направление света. LED-модуль.



○ White / W

● Black / B

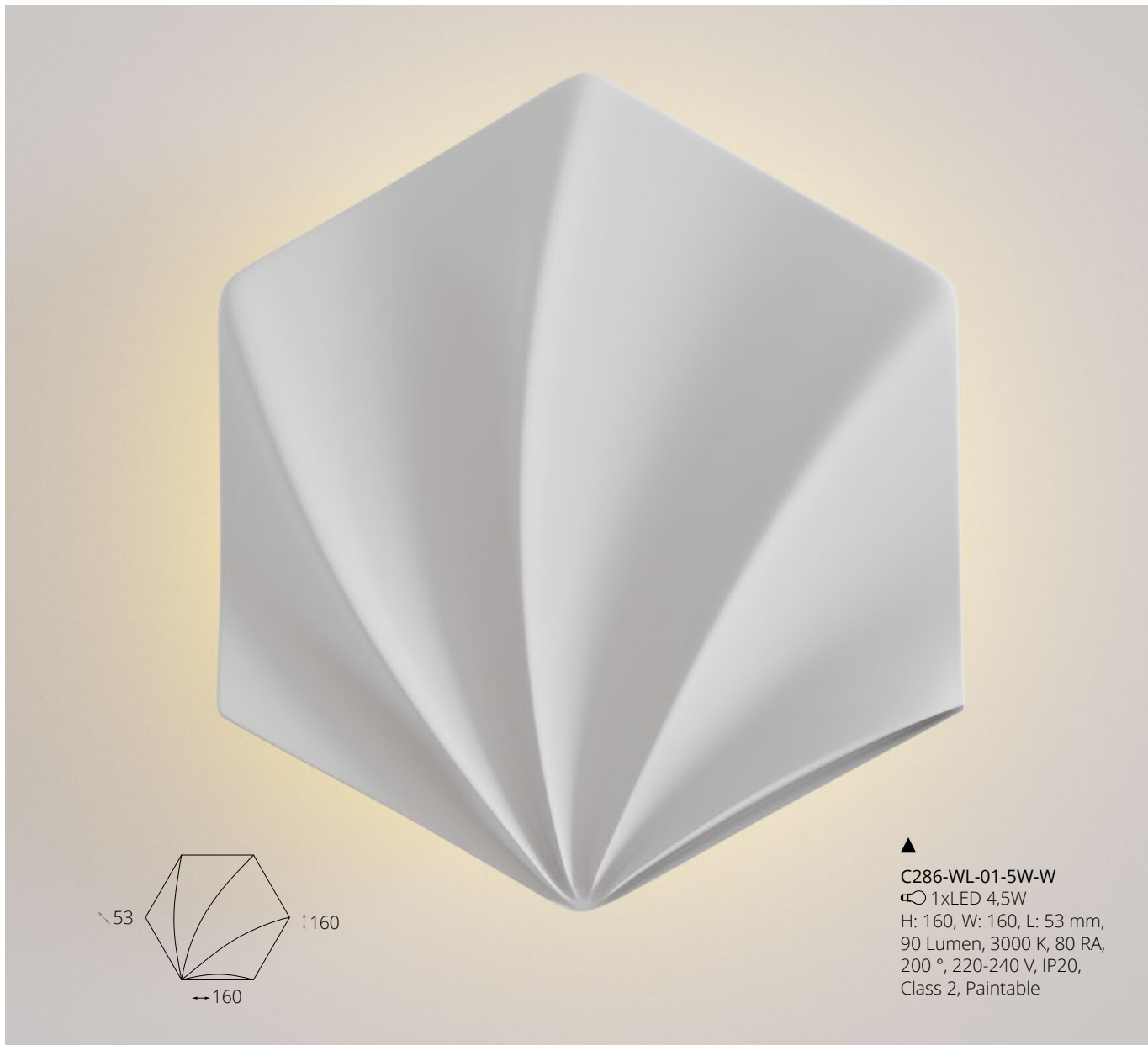

▲
C286-WL-01-5W-W
 ☉ 1xLED 4,5W
 H: 160, W: 160, L: 53 mm,
 90 Lumen, 3000 K, 80 RA,
 200 °, 220-240 V, IP20,
 Class 2, Paintable

MIXED MOODS

en Wall lamp. White plaster body. Paintable. **de** Ausgefallene Wandleuchte mit weißem Gipskörper zum anmalen.
fr Applique murale. Corps en plâtre blanc. Peut être peinte. **it** Lampada da parete in gesso bianco. Verniciabile.
es Aplique de pared. Cuerpo de yeso blanco. Puede pintarse. **pl** Lampa ścienna. Obudowa o wyglądzie białego tynku. Możliwość malowania. **ru** Настенный светильник. Корпус из белого гипса. Возможность окрашивания.



White / W

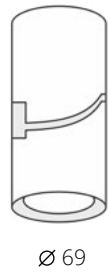

↓ 192

Ø 69



◀
C019CW-01W
 LED 10W
 H: 192, D: 69 mm,
 800 Lumen, 3000 K, 80 RA,
 24 °, 220-240 V, IP20,
 Class 2

TUBE

en Powder coated aluminium body. Adjustable 80° vertical. Integrated LED module. **de** Pulverbeschichteter Korpus aus Aluminium. Vertikal um 80° verstellbar. Integriertes LED Modul. **fr** Corps en aluminium enduit de poudre. Réglable à 180 ° horizontalement - 90 ° verticalement. Module LED. **it** Corpo in alluminio verniciato a polvere. Orientabile a 80° in verticale. Modulo LED integrato. **es** Estructura de aluminio metalizado. Ajustable 80 ° vertical con módulo LED integrado. **pl** Aluminiowa obudowa malowana proszkowo, z możliwością regulacji pod kątem 80° w pionie. Zintegrowany moduł LED. **ru** Корпус из алюминия с порошковым окрашиванием. Регулировка направления светового потока 80° (по вертикали). Встроенный LED-модуль.



○ White / W

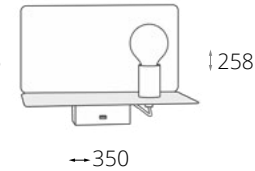
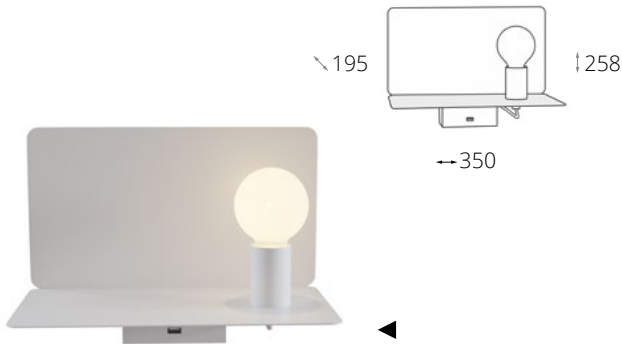

◀
C182-TL-01-W
 1xE27 50W
 H: 258, W: 350, L: 195 mm,
 Class 2

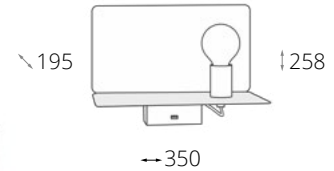
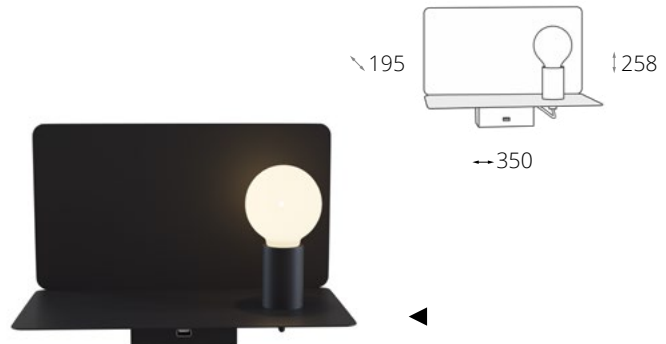

◀
C182-TL-01-B
 1xE27 50W
 H: 258, W: 350, L: 195 mm,
 Class 2

RACK

en Metal frame, USB port. **de** Metallrahmen, USB-Anschluss. **fr** Support en métal, port USB. **it** Struttura in metallo, porta USB. **es** Estructura metálica, puerto USB. **pl** Metalowe obramowanie, port USB. **ru** Арматура из металла. Наличие USB-разъема.



○ White / W

● Black / B



▲
C608-WL-01-W
 1x E27 60W
 H: 330, W: 193, L: 106 mm

HILL

en Wall lamp. Metal frame, matte glass lampshade with sand-blasted pattern. **de** Moderne Wandleuchte mit Metallbasis. Lampenschirm aus Opakglas mit sandgestrahlter Oberfläche. **fr** Applique murale. Structure en métal, diffuseur en verre mat avec motif sablé. **it** Applique. Struttura in metallo, diffusore in vetro opaco con motivo sabbaiato. **es** Estructura de metal, difusor de vidrio con motivo decorativo hecho mediante técnica del arenado. **pl** Lampa ścienna. Metalowe obramowanie, matowy klosz szklany z piaskowanym wzorem. **ru** Настенный светильник. Арматура из металла, плафон из матового стекла с пескоструйным рисунком.

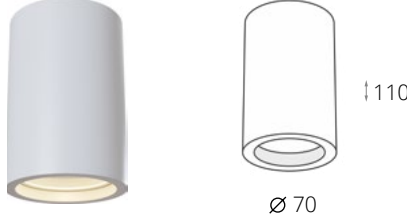
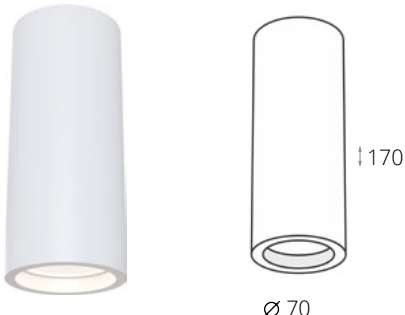
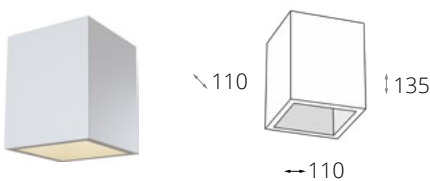

○ White / W

	Article	Input voltage	IP
<p>1xGU10 30W H: 135, D: 110 mm, Paintable</p> 	C001CW-01W	220-240 V	20
<p>1xGU10 30W H: 110, D: 70 mm, Paintable</p> 	C003CW-01W	220-240 V	20
<p>1xGU10 30W H: 170, D: 70 mm, Paintable</p> 	C004CW-01W	220-240 V	20
<p>1xGU10 30W H: 135, W: 110, L: 110 mm, Paintable</p> 	C002CW-01W	220-240 V	20

CONIK GYPS

en Paintable plaster body. GU10 bulbs. **de** Bemalbarer Korpus aus Gips. GU10-Glühlampen. **fr** Corps en plâtre pouvant être peint. Ampoules GU10. **it** Corpo in gesso verniciabile. Lampadine GU10. **es** Estructura de yeso pintable. Bombillas GU10. **pl** Nadająca się do malowania obudowa gipsowa. Żarówki GU10. **ru** Корпус из гипса. Возможность окрашивания. Рекомендуется использовать лампочки GU10.



○ White / W



	Article	Input voltage	IP
1xGU10 30W H: 110, W: 70, L: 70 mm, Paintable	C005CW-01W	220-240 V	20

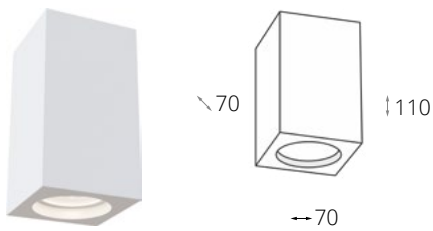

1xGU10 30W H: 170, W: 70, L: 70 mm, Paintable	C006CW-01W	220-240 V	20
---	------------	-----------	----

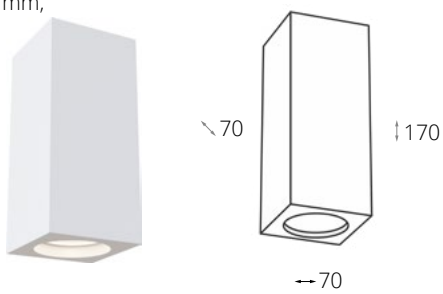

1xGU10 50W
H: 115, D: 85 mm,
Class 2



Article	Input voltage	IP
C012CL-01W	220-240 V	20
C012CL-01B	220-240 V	20

1xGU10 50W
H: 115, D: 85 mm,
Class 2



C014CL-01W	220-240 V	20
------------	-----------	----

1xGU10 50W
H: 130, D: 60 mm,
Class 2

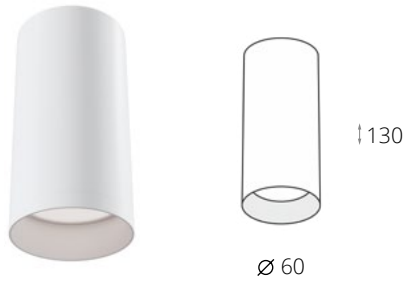

C010CL-01W	220-240 V	20
C010CL-01B	220-240 V	20

1xGU10 50W
H: 115, D: 85 mm,
Class 2

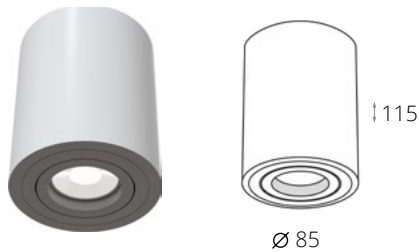

C016CL-01W	220-240 V	20
C016CL-01B	220-240 V	20

ALFA

en Powder coated aluminium body. Metal socket. **de** Pulverbeschichteter Korpus aus Aluminium. Fassung aus Metall. **it** Corps en aluminium enduit de poudre. Douille en métal. **it** Corpo in alluminio verniciato a polvere. Zoccolo in metallo. **es** Estructura de aluminio metalizada. Toma de metal. **pl** Aluminiowa obudowa malowana proszkowo, gniazdko metalowe. **ru** Корпус из алюминия с порошковым окрашиванием. Источник света фиксируется металлическим кольцом, которое скрывает внутренние части светильника и окантовку лампы.



○ White / W

● Black / B

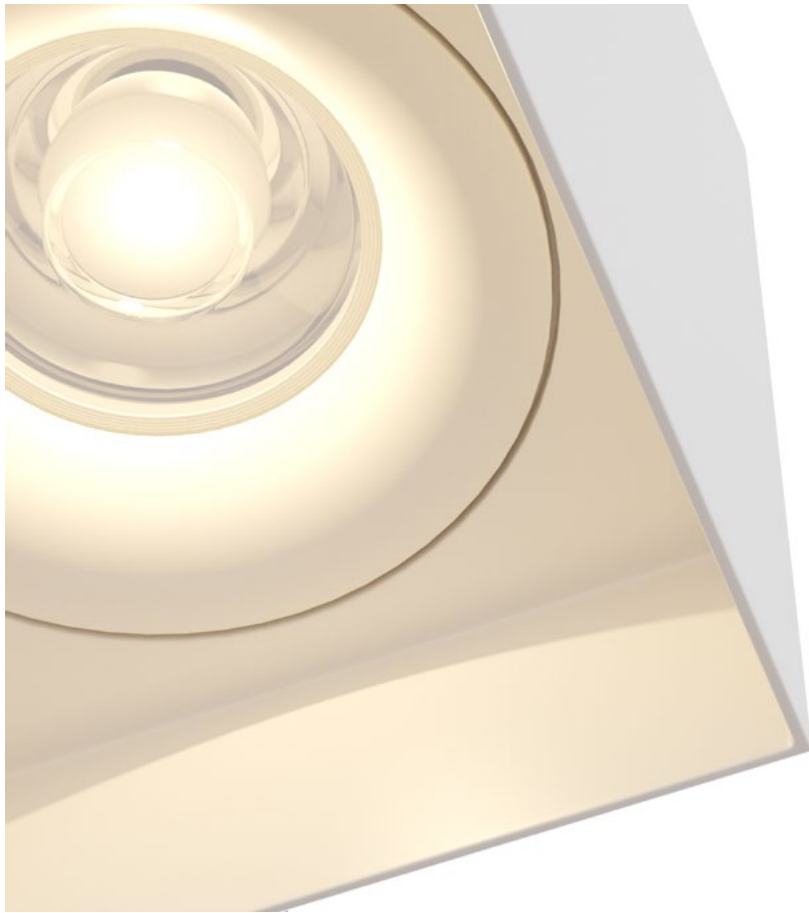

1xGU10 50W
H: 115, W: 90, L: 90 mm,
Class 2

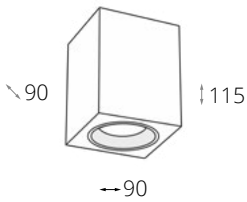

Article	Input voltage	IP
C013CL-01W	220-240 V	20
C013CL-01B	220-240 V	20

1xGU10 50W
H: 115, W: 70, L: 70 mm,
Class 2

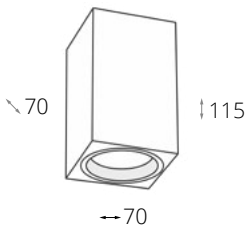

C011CL-01W	220-240 V	20
------------	-----------	----

1xGU10 50W
H: 115, W: 90, L: 90 mm,
Class 2

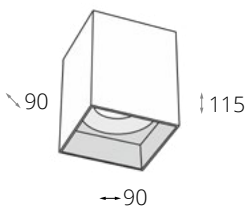

C015CL-01W	220-240 V	20
C015CL-01B	220-240 V	20



▲
C177WL-L4W
☉ LED 6W
H: 60, D: 205, L: 80 mm,
600 Lumen, 3100 K, > 80 RA,
150 °, 220-240 V, IP20

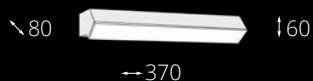

▲
C177WL-L8W
☉ LED 12W
H: 60, D: 370, L: 80 mm,
1150 Lumen, 3100 K, > 80 RA,
150 °, 220-240 V, IP20



▲
C177WL-L12W
☉ LED 18W
H: 60, D: 535, L: 80 mm,
1650 Lumen, 3100 K, > 80 RA,
150 °, 220-240 V, IP20

TONI

en Metal frame, acrylic diffuser. LED module. **de** Metallrahmen, Diffusor aus Acryl. LED Modul. **fr** Support en métal, diffuseur en acrylique. Module LED. **it** Struttura in metallo, diffusore in acrilico. Modulo LED. **es** Estructura metálica, difusor acrílico. Módulo LED. **pl** Metalowe obramowanie, dyfuzor akrylowy. Moduł LED. **ru** Арматура из металла. Корпус из металла. Рассеиватель из акрила. Встроенный LED-модуль.



● White / W



▲
C815WL-L6W
LED 6W
H: 50, D: 240, L: 105 mm,
530 Lumen, 3000 K, > 80 RA,
120 °, 220-240 V, IP20



▲
C815WL-L12W
LED 12W
H: 50, D: 405, L: 105 mm,
1200 Lumen, 3000 K, > 80 RA,
120 °, 220-240 V, IP20

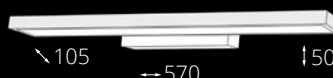

▲
C815WL-L18W
LED 18W
H: 50, D: 570, L: 105 mm,
1550 Lumen, 3000 K, > 80 RA,
120 °, 220-240 V, IP20

EVERETT

en Metal frame, integrated LED module. Sandblasted white finish. **de** Metallrahmen, integriertes LED Modul. Sandgestrahlte weiße Ausführung. **fr** Support en métal, module LED intégré. Finition blanche sablée. **it** Struttura in metallo, modulo LED integrato. Finitura bianco sabbaiato. **es** Estructura metálica, módulo LED integrado. Acabado blanco arenado. **pl** Metalowe obramowanie, zintegrowany moduł LED. Wykończenie piaskowane na biało. **ru** Арматура из металла с пескоструйной обработкой, цвет - белый. LED-модуль.



● White / W



◀ C190-WL-02-W
 ⚡ 2xG9 5W
 H: 220, W: 70, L: 70 mm,
 Paintable

PARMA

en White plaster body. LED module. Paintable **de** Weißer Gipskorpus. LED Modul. Bemalbar. **fr** Corps en plâtre blanc. Module LED. Peut être peint. **it** Corpo in gesso bianco. Modulo LED. Verniciabile. **es** Estructura de yeso blanco. Módulo LED Pintable. **pl** Obudowa o wyglądzie białego tynku. Moduł LED. Możliwość malowania. **ru** Корпус из белого гипса. LED-модуль. Возможность окрашивания.



○ White / W

	Article	Luminous flux	CCT	RA	Beam angle	Input voltage	IP
 2xLED 6W H: 100, W: 100, L: 100 mm, Paintable	C155-WL-02-3W-W	580 LM	3000 K	> 80	120 °	220-240 V	20

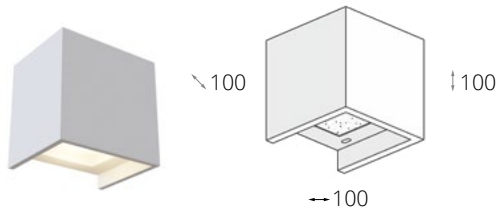

 2xLED 6W H: 155, W: 155, L: 50 mm, Class 2, Paintable	C123-WL-02-3W-W	580 LM	3000 K	> 80	120 °	220-240 V	20
---	-----------------	--------	--------	------	-------	-----------	----

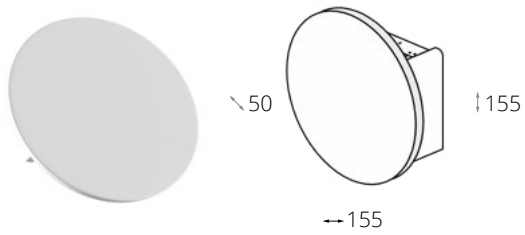

	Article	Input voltage	IP
 2xGU10 5W H: 200, W: 80, L: 100 mm, Paintable	C191-WL-02-W	220-240 V	20

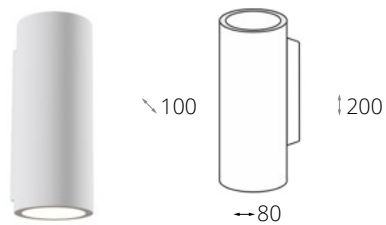

 2xG9 5W H: 220, W: 70, L: 70 mm, Paintable	C190-WL-02-W	220-240 V	20
--	--------------	-----------	----

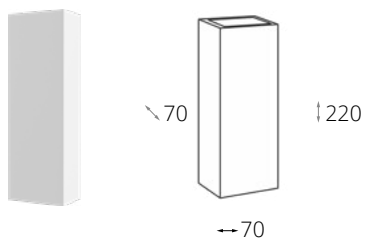



TRAME

en Metal frame, LED module. **de** Metallrahmen, LED Modul. **fr** Support en métal. Module LED. **it** Struttura in metallo, modulo LED. **es** Estructura metálica. Módulo LED. **pl** Metalowe obramowanie, moduł LED. **ru** Арматура из металла, LED-модуль.



○ White / W

● Black / B

	Article	Luminous flux	CCT	RA	Beam angle	Input voltage	IP
 LED 12W H: 125, W: 260, L: 55 mm	C804WL-L12W	400 LM	3000 K	> 80	360 °	220-240 V	20



 LED 7W H: 186, W: 160, L: 63 mm	C805WL-L7B	380 LM	3000 K	> 80	360 °	220-240 V	20
--	-------------------	--------	--------	------	-------	-----------	----

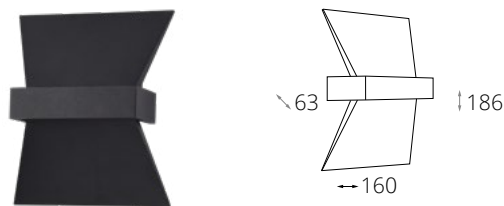

 LED 5W H: 80, W: 175, L: 96 mm	C806WL-L5W	380 LM	3000 K	> 80	300 °	220-240 V	20
---	-------------------	--------	--------	------	-------	-----------	----

	C806WL-L5B	380 LM	3000 K	> 80	300 °	220-240 V	20
--	-------------------	--------	--------	------	-------	-----------	----



 LED 3W H: 205, W: 245, L: 75 mm	C808WL-L3B	150 LM	3000 K	> 80	90 °	220-240 V	20
--	-------------------	--------	--------	------	------	-----------	----

	C808WL-L3W	150 LM	3000 K	> 80	90 °	220-240 V	20
--	-------------------	--------	--------	------	------	-----------	----

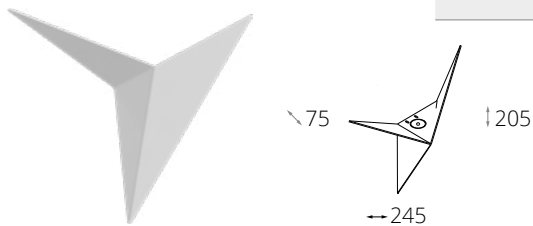

 LED 7W H: 100, W: 150, L: 110 mm	C807WL-L7W	350 LM	3000 K	> 80	180 °	220-240 V	20
---	-------------------	--------	--------	------	-------	-----------	----





ELTI

en Surface-mounted ceiling lamp. Metal frame with powder painting to exclude scratches. Static base. Adjustment of light flow direction horizontally (355°), vertically (355°). **de** Deckenaufbauleuchte. Metallrahmen mit Pulverlackierung zum Ausschluss von Kratzern. Statische Basis. Einstellung der Lichtstromrichtung horizontal (355°), vertikal (355°). **fr** Lampe à fixer au plafond. Armature en métal recouverte de poudre de peinture protégeant des rayures. Base statique. Réglage de la direction du flux lumineux horizontalement (355°), verticalement (355°). **it** Lampada da soffitto. Struttura in metallo con verniciatura a polvere. Base statica. Regolazione della direzione del flusso luminoso in orizzontale (355°) e in verticale (355°). **es** Plafón de techo y de pared. Estructura de metal con coloración en polvo. Eliminando arañazos. Fundación estática. La dirección ajustada de corriente de luz de horizontal (355°), y vertical (355°). **pl** Lampa sufitowa natynkowa. Metalowa rama z powłoką proszkową zapobiegającą zarysowaniom. Podstawa statyczna. Regulacja kierunku przepływu światła w poziomie (355°), w pionie (355°). **ru** Накладной потолочный светильник. Корпус из металла с порошковым окрашиванием, исключающим появление царапин. Статичное основание. Регулировка направления светового потока по горизонтали (355°), по вертикали (355°).



○ White / W

● Black / B



▲
C021CL-02B/W
 2xGU10 50W
 H: 770, W: 200, L: 53 mm,
 □ d=53 / h=200,
 220-240 V, IP20

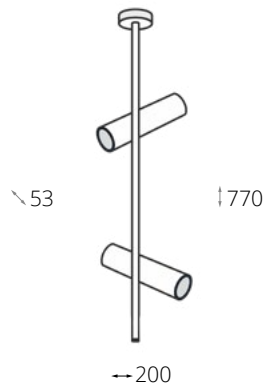

▲
C020CL-01B/W
 1xGU10 50W
 H min: 200, H max: 280,
 W: 200, L: 53 mm,
 □ d=53 / h=200,
 220-240 V, IP20

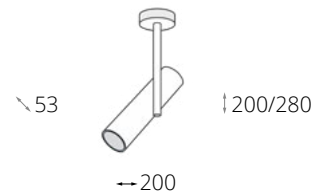

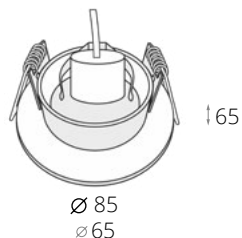

DL027-2-01W
 1xGU10 50W
 H: 65, D: 85 mm,
 220-240 V, IP20,
 Class 2

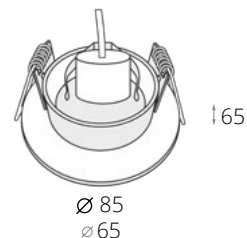

DL027-2-01B
 1xGU10 50W
 H: 65, D: 85 mm,
 220-240 V, IP20,
 Class 2

SLIM

en Recessed light. Powder coated metal body. **de** Einbauleuchte. Pulverbeschichteter Korpus aus Metall. **fr** Lumière encastrée. Corps en métal enduit de poudre. **it** Faretto da incasso. Corpo in metallo verniciato a polvere. **es** Downlight empotrable, estructura metálica con recubrimiento en polvo. **pl** Wbudowany reflektor. Metalowa obudowa malowana proszkowo. **ru** Встраиваемый светильник. Корпус из металла с порошковым окрашиванием.



○ White / W

● Black / B

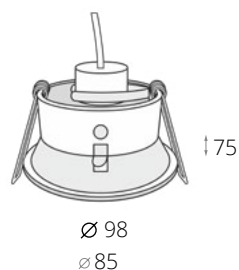

DL030-2-01W
 1xGU10 50W
 H: 75, D: 98 mm,
 220-240 V, IP20,
 Class 2

YIN

en Built-in ceiling lamp. Metal frame with powder painting. **de** Decken-Einbauleuchte mit Aluminiumrahmen. Eine spezielle Puderbeschichtung schützt vor mechanischen Schäden. **fr** Plafonnier encastré. Cadre en aluminium avec revêtement en poudre qui protège contre les dommages mécaniques. **it** Faretto da incasso. Struttura in metallo verniciata a polvere. **es** Lámpara de techo empotrada. Armazón de metal recubierta con pintura en polvo, que elimina el surgimiento de arañas. **pl** Oprawa sufitowa wpuszczana z ramą aluminiową. Specjalna powłoka proszkowa chroni przed uszkodzeniami mechanicznymi. **ru** Встраиваемый светильник. Корпус из металла с порошковым окрашиванием, защищающим от механического повреждения.



○ White / W

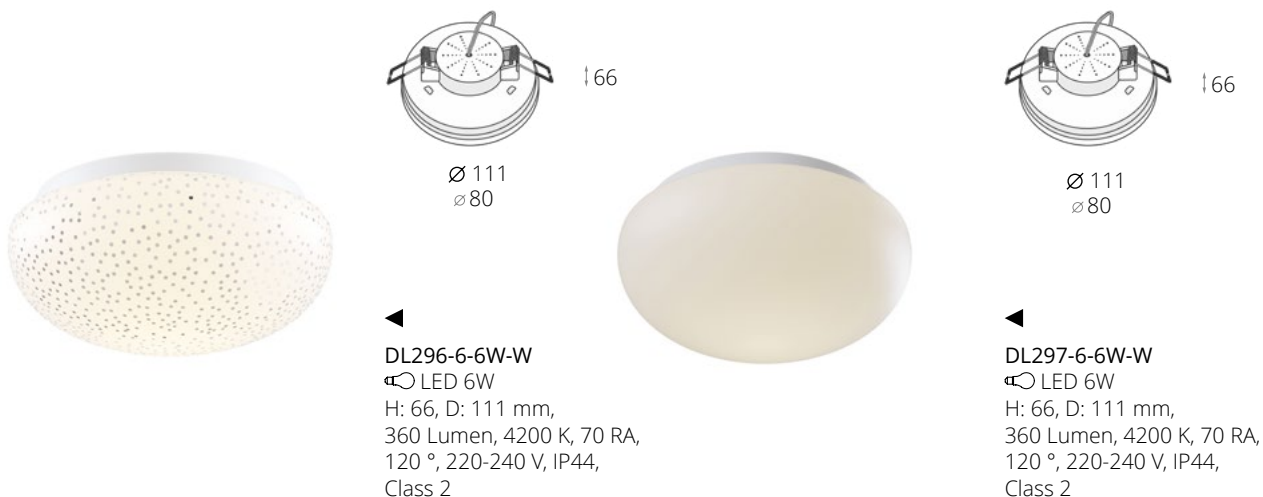

PLASTIC

en Recessed downlight with glitter or white diffuser. **de** Einbaudownlight mit Glitzer oder weißem Diffusor. **fr** Lumière encastrée dimmable avec diffuseur paillettes ou blanc. **it** Faretto da incasso con diffusore a effetto glitter o bianco. **es** Downlight empotrado con purpurina o difusor blanco. **pl** Wbudowany downlight, dyfuzor z brokatem lub biały. **ru** Встраиваемый спот. Рассеиватель из пластика белого цвета или белого цвета с прозрачными точками.



○ White / W



PLANET

en Ceiling lamp. Aluminium frame. Two light sources: main light and backlight. Work in three modes of lighting. **de** Deckenlampe. Aluminiumrahmen. Zwei Lichtquellen: Hauptlicht und Hintergrundbeleuchtung. Drei Beleuchtungsarten möglich. **fr** Plafonnier. Armature en aluminium. Deux sources lumineuses: lumière principale et rétro-éclairage. Fonctionne dans trois modes d'éclairage. **it** Lampada da soffitto. Struttura in alluminio. Due sorgenti luminose: una principale e una posteriore. Tre diversi tipi di illuminazione. **es** Plafón de techo. Carcasa de aluminio. Dos puntos de luz: general y retroiluminación. Funciona en 3 modos de iluminación. **pl** Lampa sufitowa. Rama aluminiowa. Dwa źródła światła: światło główne i podświetlenie. Praca w trzech trybach oświetlenia. **ru** Потолочный светильник. Корпус из алюминия. Два источника света: основной и подсветка. Работает в 3-х режимах освещения.



○ White / W

● Black / B

1xGU10 50W
H: 60, D: 92 mm,
Class 2

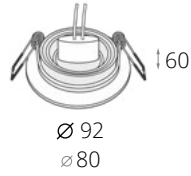

Article	Input voltage	IP
DL023-2-01S	220-240 V	20
DL023-2-01B	220-240 V	20
DL023-2-01W	220-240 V	20

1xGU10 50W
H: 60, W: 92, L: 92 mm,
Class 2

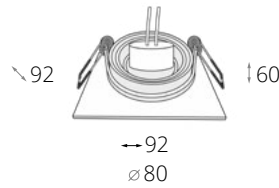

DL024-2-01S	220-240 V	20
DL024-2-01B	220-240 V	20
DL024-2-01W	220-240 V	20

2xGU10 50W
H: 60, W: 175, L: 92 mm,
Class 2

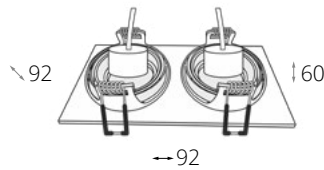

DL024-2-02S	220-240 V	20
DL024-2-02B	220-240 V	20
DL024-2-02W	220-240 V	20

3xGU10 50W
H: 60, W: 256, L: 92 mm,
Class 2

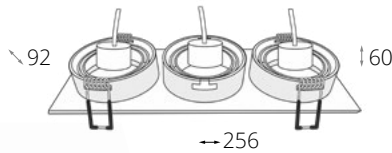

DL024-2-03S	220-240 V	20
DL024-2-03B	220-240 V	20
DL024-2-03W	220-240 V	20

ATOM

en Recessed downlight, adjustable 25°. Powder coated metal body. **de** Einbaudownlight, verstellbar um 25°. Pulverbeschichteter Korpus aus Metall. **fr** Lumière dimmable encastrée, réglable à 25°. Corps en métal enduit de poudre. **it** Faretto da incasso, orientabile a 25°. Corpo in metallo verniciato a polvere. **es** Downlight empotrable, ajustable 25°. Estructura metálica con recubrimiento en polvo. **pl** Wbudowany reflektor, regulowany pod kątem 25°. Metalowa obudowa malowana proszkowo. **ru** Встраиваемый светильник. Регулировка направления светового потока в одной плоскости 25°. Корпус из металла с порошковым окрашиванием.



○ White / W

● Black / B

○ Silver / S

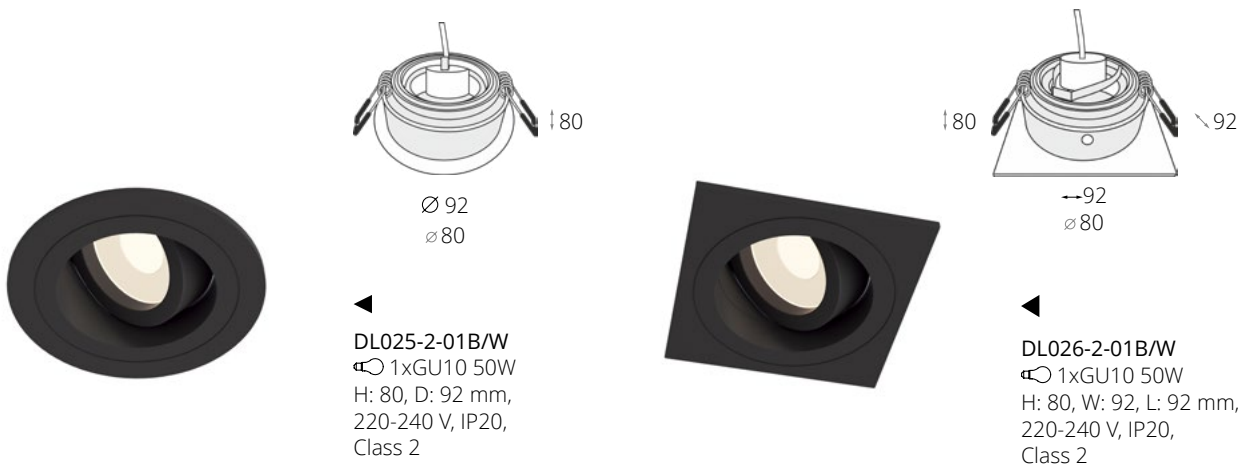

AKRON

en Recessed light. Powder coated metal body. **de** Einbauleuchte. Pulverbeschichteter Korpus aus Metall. **fr** Lumière encastrée. Corps en métal enduit de poudre. **it** Faretto da incasso. Corpo in metallo verniciato a polvere. **es** Downlight empotrable, estructura metálica con recubrimiento en polvo. **pl** Wbudowany reflektor. Metalowa obudowa malowana proszkowo. **ru** Встраиваемый светильник. Корпус из металла с порошковым окрашиванием.



○ White / W

● Black / B



	Article	Input voltage	IP
1xGU10 30W H: 180, W: 120, L: 91 mm, Class 2, Paintable	DL012-1-01W	220-240 V	20

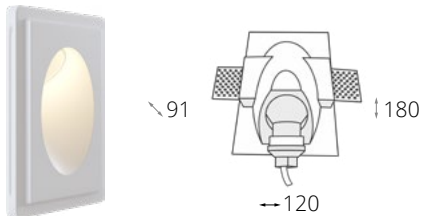

1xGU10 30W H: 250, W: 210, L: 75 mm, Class 2, Paintable	DL011-1-01W	220-240 V	20
---	-------------	-----------	----

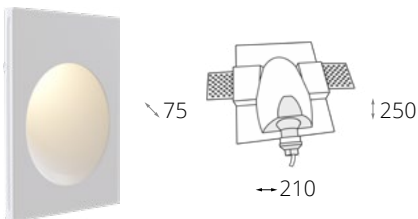

GYPS MODERN

en Recessed light, white plaster body. Paintable. **de** Einbauleuchte, weißer Korpus aus Gips. Bemalbar. **fr** Spot intégré, corps en plâtre blanc, peignable. **it** Faretto da incasso, corpo in gesso bianco. Verniciabile. **es** Luz empotrada de yeso blanco. Pintable. **pl** Wbudowany reflektor, obudowa o wyglądzie białego tynku. Możliwość malowania. **ru** Встраиваемый спот. Корпус из белого гипса. Возможность окрашивания.



○ White / W

	Article	Input voltage	IP
<p>1xGU10 35W H: 135, W: 120, L: 120 mm, Class 2, Paintable</p> 	DL001-1-01-W	220-240 V	20
<p>1xGU10 35W H: 150, D: 130 mm, Class 2, Paintable</p> 	DL002-1-01-W	220-240 V	20
<p>1xGU10 35W H: 110, D: 121 mm, Class 2, Paintable</p> 	DL004-1-01-W	220-240 V	20
<p>1xGU10 35W H: 114, W: 122, L: 122 mm, Class 2, Paintable</p> 	DL005-1-01-W	220-240 V	20
<p>1xGU10 35W H: 122, D: 110 mm, Class 2, Paintable</p> 	DL006-1-01-W	220-240 V	20
<p>2xGU10 35W H: 110, W: 230, L: 120 mm, Class 2, Paintable</p> 	DL002-1-02-W	220-240 V	20



METAL MODERN

en Aluminum modular recessed light. **de** Modulbare Einbauleuchte aus Aluminium. **fr** Spot encastré, module en aluminium. **it** Faretto da incasso modulare in alluminio. **es** Empotrable modular de aluminio. **pl** Aluminiowy modul, wbudowany reflektor. **ru** Встраиваемый модульный спот из алюминия.





- | | | | |
|---|--|---|--|
|  White / W |  Black / B |  Silver / S |  Gold / G |
|  Chrome / CH |  Brass / BS |  White-Chrome / W-CH | |

	Article	Input voltage	IP
<p>1xGU10 50W H: 78, W: 126, L: 126 mm</p>  	DL008-2-01-S	220-240 V	20
	DL008-2-01-B	220-240 V	20
	DL008-2-01-W	220-240 V	20
<p>2xGU10 50W H: 78, W: 245, L: 126 mm</p>  	DL008-2-02-S	220-240 V	20
	DL008-2-02-B	220-240 V	20
	DL008-2-02-W	220-240 V	20
<p>1xGU10 50W H: 72, D: 91 mm, Class 2</p>  	DL287-2-3W-W	220-240 V	20
<p>1xGU10 50W H: 72, D: 90 mm, Class 2</p>  	DL289-2-01-W	220-240 V	20
<p>1xGU10 50W H: 72, W: 90, L: 90 mm, Class 2</p>  	DL290-2-01-W	220-240 V	20
<p>1xGU10 50W H: 72, D: 77 mm, Class 2</p>  	DL009-2-01-W	220-240 V	20

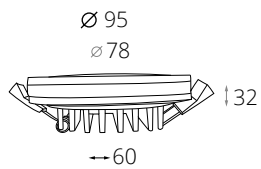

	Article	Luminous flux	CCT	RA	Beam angle	Input voltage	IP
 LED 12W H: 32, D: 95 mm, Class 2	DL2001-L12W	750 LM	3000 K	80	120 °	220-240 V	20



 LED 12W
 H: 32, W: 95, L: 95 mm,
 Class 2

DL2001-L12B	750 LM	3000 K	80	120 °	220-240 V	20
-------------	--------	--------	----	-------	-----------	----

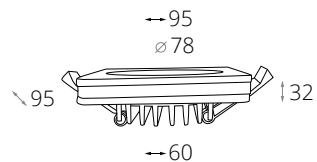

PHANTON

en Built-in lamps. Aluminium frame. LED module. **de** Einbauleuchten. Aluminiumrahmen. Modul LED. **fr** Lampes intégrées. Cadre en aluminium. Module LED. **it** Faretto da incasso. Struttura in alluminio. Modulo LED. **es** Lámparas encajadas. Caja de aluminio. Modulo LED. **pl** Wbudowane lampy. Rama aluminiowa. Moduł LED. **ru** Встраиваемые светильники. Корпус из алюминия. LED-модуль.



○ White / W

● Black / B

	Article	Luminous flux	CCT	RA	Beam angle	Input voltage	IP
 LED 7W H: 32, D: 80 mm, Class 2	DL303-L7B	400 LM	3000 K	80	120 °	220-240 V	20

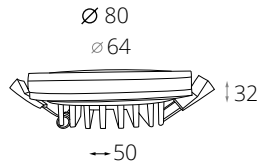

 LED 7W H: 32, W: 80, L: 80 mm, Class 2	DL303-L7W	400 LM	3000 K	80	120 °	220-240 V	20
--	-----------	--------	--------	----	-------	-----------	----

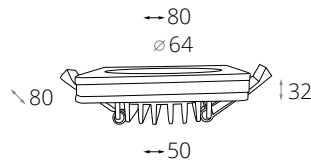

 LED 12W H: 32, W: 95, L: 95 mm, Class 2	DL303-L12W	750 LM	3000 K	80	120 °	220-240 V	20
---	------------	--------	--------	----	-------	-----------	----

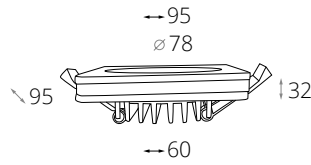

 LED 12W H: 32, D: 95 mm, Class 2	DL303-L12B	750 LM	3000 K	80	120 °	220-240 V	20
--	------------	--------	--------	----	-------	-----------	----

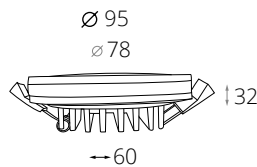

 LED 7W H: 32, D: 80 mm, Class 2	DL2001-L7W	400 LM	3000 K	80	120 °	220-240 V	20
---	------------	--------	--------	----	-------	-----------	----

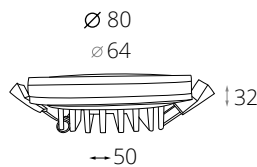

 LED 7W H: 32, W: 80, L: 80 mm, Class 2	DL2001-L7B	400 LM	3000 K	80	120 °	220-240 V	20
--	------------	--------	--------	----	-------	-----------	----

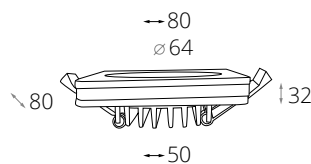





ZOOM

en Built-in lamps. Aluminium frame. Integrated LED module (models DL031). **de** Einbauleuchten. Aluminiumrahmen. Integriertes LED-Modul (Modelle DL031). **fr** Lampes intégrées. Cadre en aluminium. Module LED intégré (modèles DL031). **it** Faretto da incasso. Struttura in alluminio. Modulo LED integrato (Modelli DL031). **es** Lámparas encajadas. Caja de aluminio. Modulo LED (modelos DL031). **pl** Wbudowane lampy. Rama aluminiowa. Zintegrowany moduł LED (modele DL031). **ru** Встраиваемые светильники. Корпус из алюминия. Встроенный LED-модуль (модели DL031).





○ White / W

● Black / B

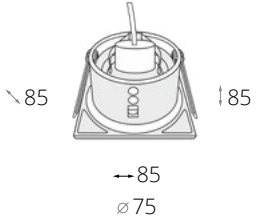
	Article	Input voltage	IP
<p>1xGU10 50W H: 85, D: 85 mm, Class 2</p>  	DL032-2-01W	220-240 V	65
	DL032-2-01B	220-240 V	65

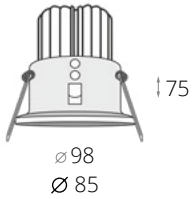
<p>1xGU10 50W H: 85, W: 85, L: 85 mm, Class 2</p>  	DL033-2-01W	220-240 V	65
	DL033-2-01B	220-240 V	65

	Article	Luminous flux	CCT	RA	Beam angle	Input voltage	IP
<p>LED 12W H: 75, D: 98 mm</p>  	DL031-2-L12B	950 LM	3000 K	80	40 °	220-240 V	20
	DL031-2-L12W	950 LM	3000 K	80	40 °	220-240 V	20

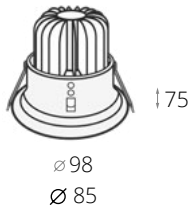
<p>LED 8W H: 75, D: 98 mm</p>  	DL031-2-L8B	650 LM	3000 K	80	40 °	220-240 V	20
	DL031-2-L8W	650 LM	3000 K	80	40 °	220-240 V	20



Modern
Pendant
Table & Floor
Mirror
Ceiling & Wall

MAYTONI MODERN



◀
 MOD446-22-N
 LED 38W
 H: 525, D: 530 mm,
 1525 Lumen, 3000 K



▲
 MOD446-11-N
 LED 15W
 H: 530, D: 230 mm,
 900 Lumen, 3000 K

NASTRO

en Metal frame. Ultra-modern design using a LED module. **de** Verchromtes Metallgestell. Ultra-modernes Design mit LED-Modul. **fr** Structure en métal. Design ultra-moderne à l'aide d'un module LED. **it** Struttura in metallo. Design contemporaneo con modulo LED. **es** Estructura de metal. Diseño contemporáneo con módulo LED. **pl** Metalowe obramowanie. Ultranowoczesny design z wykorzystaniem modułu LED. **ru** Каркас из металла. Ультрасовременный дизайн с использованием LED-модуля.



● Nickel / N



◀
MOD446-01-N
LED 26W
H: 430, D: 470 mm,
1144 Lumen, 3000 K

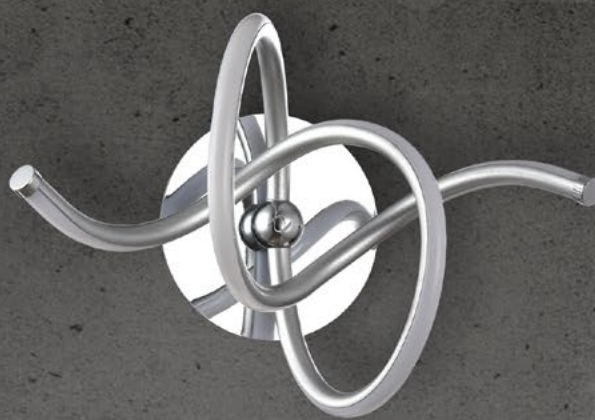

▲
MOD446-02-N
LED 12W
H: 210, W: 370, L: 240 mm,
750 Lumen, 3000 K

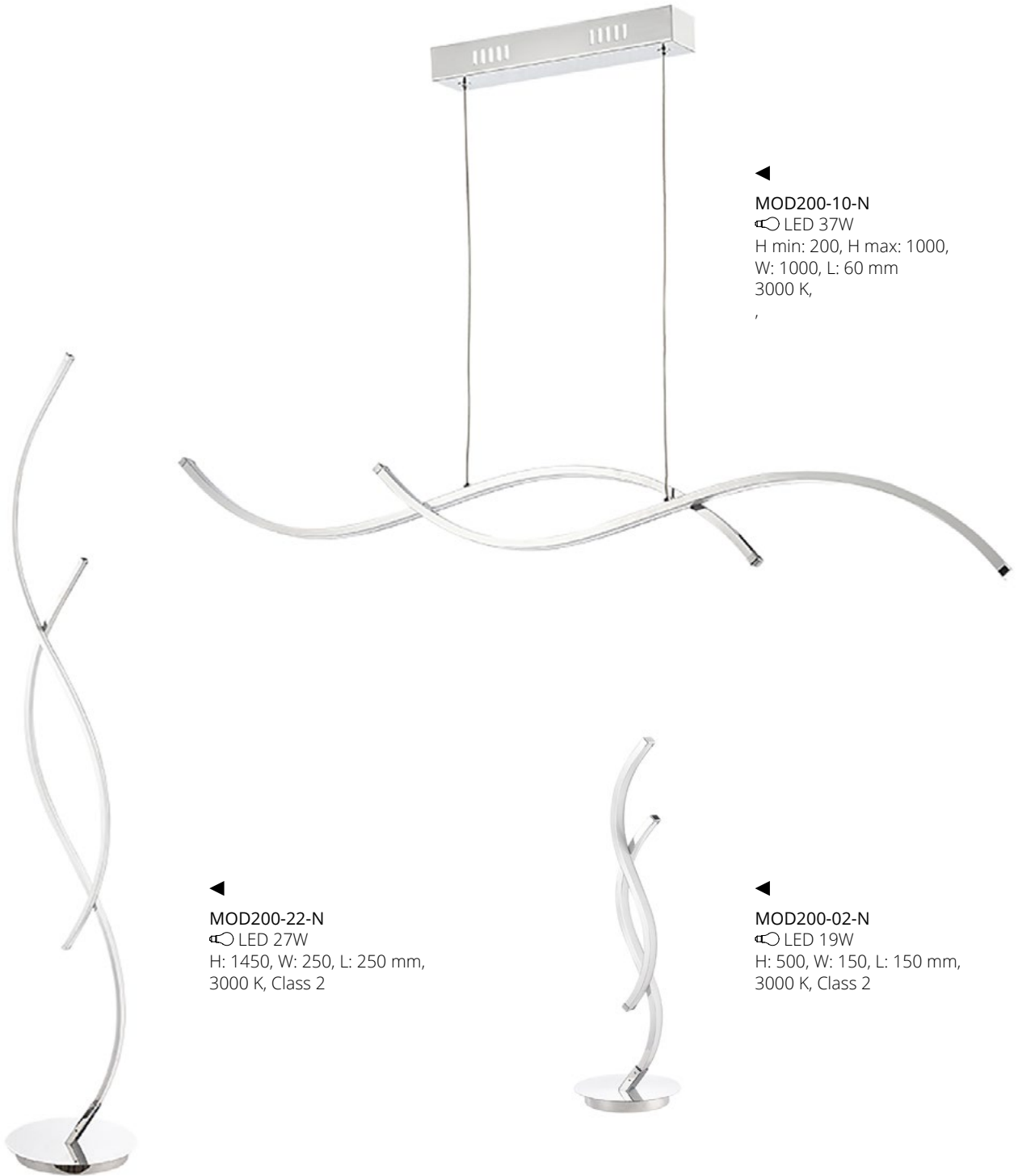

◀
MOD200-10-N
 LED 37W
 H min: 200, H max: 1000,
 W: 1000, L: 60 mm
 3000 K,

◀
MOD200-22-N
 LED 27W
 H: 1450, W: 250, L: 250 mm,
 3000 K, Class 2

◀
MOD200-02-N
 LED 19W
 H: 500, W: 150, L: 150 mm,
 3000 K, Class 2

ELLIS

en Metal frame, integrated LED module. Acrylic diffuser. **de** Metallrahmen, integriertes LED Modul. Diffusor aus Acryl. **fr** Armature métallique, module LED intégré. Diffuseur acrylique. **it** Struttura in metallo, modulo LED integrato. Diffusore in acrilico. **es** Estructura metálica, módulo LED integrado. Difusor acrílico. **pl** Metalowe obramowanie, zintegrowany moduł LED. Dyfuzor akrylowy. **ru** Арматура из металла, встроенный LED-модуль. Плафон из акрила.



● Chrome / CH





MOD211-06-N

LED 28W

H min: 505, H max: 1200,

D: 430 mm

2700 K

VENUS

en Metal frame. Ultra-modern design using a LED module. **de** Verchromter Metallkorpus im ultra-modernen Design mit LED-Modul. **fr** Structure en métal. Design ultra-moderne à l'aide d'un module LED. **it** Struttura in metallo. Design ultra-moderno con modulo LED. **es** Estructura de metal. Diseño ultra-moderno con módulo LED. **pl** Metalowe obramowanie. Ultranowoczesny design z wykorzystaniem modułu LED. **ru** Каркас из металла. Ультрасовременный дизайн с использованием LED-модуля.



● Chrome / CH



▲
MOD211-09-N
LED 66W
H min: 595, H max: 1500,
D: 620 mm





▲
MOD447-55-N
LED 43W
H: 200, D: 560 mm,
2150 Lumen



▲
MOD447-CL-3-30-W
LED 30W
H: 150, D: 560 mm,
1500 Lumen



▲
MOD447-33-N
LED 30W
H: 200, D: 540 mm,
1500 Lumen

KLEE

en Metal frame. Wall/ceiling lamp using a LED module. **de** Metallrahmen. Sowohl als Decken- und Wandleuchte montierbar. LED-Modul. **fr** Structure en métal. Applique/plafonnier LED. **it** Struttura in metallo. Lampada da muro o da soffitto con modulo LED. **es** Estructura de metal. Aplique de pared o plafón con módulo LED. **pl** Metalowe obramowanie. Lampa ścienna/sufitowa z wykorzystaniem modułu LED. **ru** Каркас из металла. Настенно-потолочный светильник с использованием LED-модуля.



● White / W

● Chrome / CH



◀
 P444-PL-01-36W-N
 LED 36W
 H min: 150, H max: 1640,
 W: 1200, L: 120 mm,
 2520 Lumen



▲
 C444-WL-01-21W-N
 LED 21W
 H: 75, W: 600, L: 100 mm,
 1470 Lumen



▲
 C444-WL-01-13W-N
 LED 13W
 H: 70, W: 450, L: 100 mm,
 910 Lumen

PLASMA

en Metal frame with glass diffuser. LED module. **de** Metallrahmen mit Diffusor aus Glas. LED Modul.
fr Armature métallique, module LED intégré. Diffuseur en verre. **it** Struttura in metallo con diffusore
 in vetro. Modulo LED. **es** Estructura metálica con difusor de cristal. Módulo LED. **pl** Metalowe
 obramowanie z dyfuzorem szklanym. Moduł LED. **ru** Арматура из металла. Плафон из стекла.
 LED-модуль.



● Nickel / N



▲
MOD809-CL-06-72-WB/W
☉ LED 72W
H: 75, W: 610, L: 495 mm,
6000/6900 Lumen



▲
MOD809-CL-04-48-W
☉ LED 48W
H: 75, W: 610, L: 481 mm,
4600 Lumen



▲
MOD809-CL-03-36-W
☉ LED 36W
H: 75, W: 548, L: 583 mm,
3400 Lumen

APRILIA

en Metal frame. Ultramodern design using LED module. **de** Deckenleuchte im modernen Design mit LED-Technologie. **fr** Armature métallique. Design ultramoderne équipé d'un module LED. **it** Struttura in metallo. Design ultramoderno con modulo LED. **es** Estructura de metal. Diseño ultramoderno con módulo LED integrado. **pl** Metalowe obramowanie. Ultranowoczesny design z wykorzystaniem modułu LED. **ru** Каркас из металла. Ультрасовременный дизайн с использованием LED-модуля.



○ White / W

◐ Black and White / BW



▲
MOD999-44-W
LED 40W
H: 115, D: 520 mm,
h=93,
Dimmable, 2800 Lumen,
3000 - 6000 K

CRYSTALLIZE

en Acrylic diffuser, LED module, RGB and dimmable. Remote control included. **de** Diffusor aus Acryl, LED Modul, RGB und dimmbar. Inklusive Fernbedienung. **fr** Diffuseur acrylique, module LED RGB, température et luminosité réglable par télécommande incluse. **it** Diffusore in acrilico, modulo LED, RGB e dimmerabile. Telecomando incluso. **es** Difusor acrílico, módulo LED, RGB y regulable. Mando a distancia incluido. **pl** Dyfuzor akrylowy, moduł LED, RGB i możliwość przyciemniania. W zestawie pilot zdalnego sterowania. **ru** Плафон выполнен из акрила. LED-модуль. Изменение цветовой температуры и яркости. Пульт дистанционного управления в комплекте.



○ White / W



▲
 MOD700-04-W
 ⚡ 4xE27 60W
 H min: 100, H max: 1200,
 D: 500 mm,
 □ h=100

ASTERO

en Metal frame. White glass lampshade. **de** Verchromter Metallrahmen. Lampenschirm aus weißem Glas. **fr** Structure en métal. Diffuseur en verre blanc. **it** Struttura in metallo. Diffusore di vetro bianco. **es** Estructura de metal. Pantalla de vidrio blanco. **pl** Metalowe obramowanie. Klosz z białego szkła. **ru** Каркас из металла. Плафон из стекла белого цвета.



● Nickel / N



▲
 MOD833-08-N
 ⚡ 8xE14 60W
 H: 280, D: 860 mm,
 □ d1=147 / d2=147 / h=130



▲
 MOD833-06-N
 ⚡ 6xE14 60W
 H: 280, D: 760 mm,
 □ d1=147 / d2=147 / h=130

JOEL

en Metal frame. White matt glass diffusers rotatable by 40°. **de** Futuristisches Metallgestell. Glasschirme aus weißem Opakglas mit 40° Schwenkradius. **fr** Armature métallique. Diffuseurs en verre blanc dépoli pivotants sur 40°. **es** Estructura in metallo. Difusori in vetro opaco bianco orientabili (40°). **it** Estructura de metal. Difusores de vidrio blanco mate que giran 40°. **pl** Metalowe obramowanie. Dyfuzory z białego matowego szkła, obracane o 40°. **ru** Каркас из металла. Плафоны из белого матового стекла поворачиваются на 40°.



● Chrome / CH



▲
MOD600PL-09W
 9xE14 60W
 H min: 610, H max: 910,
 W: 720, L: 270 mm,
 □ d=720 / h=110

MANFRED

en Metal frame with fabric shade and crystal pendants. de Metallrahmen mit Lampenschirm aus Stoff und Anhängern aus Kristall. fr Armature métallique avec abat-jour en tissu et pendentifs en cristal. it Struttura in metallo con paralume in tessuto e pendenti in cristallo. es Estructura de metal con pantalla de tela y colgantes de cristal. pl Metalowe obramowanie z abażurem z tkaniny i kryształowymi wisiorkami. ru Арматура из металла. Абажур из ПВХ покрыт тканью. Подвески из хрусталя.



● White / W



◀
MOD600PL-10W
⚡ 10xE14 60W
H min: 610, H max: 910,
D: 600 mm,
□ d=600 / h=110



◀
MOD600PL-06W
⚡ 6xE14 60W
H min: 610, H max: 910,
D: 450 mm,
□ d=450 / h=110



▲
MOD600WL-02W
⚡ 2xE14 60W
H: 185, W: 300, L: 130 mm,
□ d=300 / h=110



◀
MOD196-PL-02-W
 ⚡ 2xE14 40W
 H min: 240, H max: 1195,
 D: 250 mm,
 □ d=250 / h=170



◀
MOD196-TL-01-W
 ⚡ 1xE27 60W
 H: 320, D: 255 mm,
 □ d=255 / h=165

DELICATE

en Metal support (tripod) painted in white. Unusual lampshade design from metal curved straps. **de** Moderne Pendelleuchte. Ungewöhnliches Design des Lampenschirms in Form eines gebogenen Trägers. **fr** Support en métal en blanc. Abat-jour de design original fait de sangles métalliques ondulées. **it** Montatura in metallo verniciata in bianco. Diffusore dal design insolito con bande metalliche curve. **es** Soporte metálico pintado en blanco. Pantalla de diseño singular formado por cintas curvadas de metal. **pl** Podstawa metalowa (statyw) pomalowana na biało. Niezwykła konstrukcja abażuru z metalowych, zakrzywionych pasków. **ru** Штатив (тренога) из металла покрыт белым цветом. Необычный дизайн плафона из металлических изогнутых полос.



○ White / W





MOD112CL-08N/G

☉ 8xG9 28W

H: 320, D: 500 mm,

□ d=100



MOD112-04-N/G

☉ 4xG9 28W

H: 250, D: 380 mm,

□ d=100

BALBO

en Metal body with glass diffusers. **de** Korpus aus Metall mit Diffusoren aus Glas. **fr** Corps métallique diffuseur en verre. **it** Corpo in metallo con diffusori in vetro. **es** Armazón de metal con difusores de vidrio. **pl** Obudowa metalowa z dyfuzorami szklanymi. **ru** Корпус из металла, плафоны выполнены из стекла.



● Nickel / N

● Gold / G



◀
MOD112-08-G/N
⚡ 8xG9 28W
H min: 400, H max: 1700,
D: 500 mm,
□ d=100 / h=100



◀
MOD431-PL-06-WG/WS
 ⚡ 6xG9 40W
 H min: 275, H max: 1200,
 D: 650 mm,
 □ d=100



◀
MOD431-TL-01-WS/WG
 ⚡ 1xG9 40W
 H: 395, W: 230, L: 25 mm,
 □ d=100,
 Class 2



◀
MOD431-WL-01-WS/WG
 ⚡ 1xG9 40W
 H: 250, W: 178, L: 110 mm,
 □ d=100

AVOLA

en Metal frame, matt white finish. Glass diffusers. **de** Metallrahmen, matt weiß lackiert. Diffusoren aus Glas. **fr** Armature métallique, finition blanc mat. Diffuseur en verre. **it** Struttura in metallo, finitura bianco opaco. Diffusori in vetro. **es** Estructura de metal, acabado blanco mate. Difusores de vidrio. **pl** Metalowe obramowanie, wykończenie w kolorze białym matowym. Dyfuzory szklane. **ru** Арматура из металла окрашена в белый матовый цвет. Плафоны из стекла.



◉ White and Silver / WS ◉ White with Gold / WG



▲
MOD431-PL-01-WS/WG
☉ 1xG9 40W
H min: 320, H max: 1200,
W: 178, L: 25 mm,
□ d=100



▲
MOD012CL-12G
 ⚡ 12xG9 28W
 H min: 275, H max: 1300,
 D: 1270 mm,
 □ h=270



▲
MOD012CL-06G
 ⚡ 6xG9 28W
 H: 350, D: 1250 mm,
 □ h=270

VENTURA

en Metal frame, amber glass diffusers. **de** Metallrahmen, Bernsteinfarbige Diffusoren.
fr Armature métallique, diffuseur verre ambré. **it** Struttura in metallo, diffusori
 in vetro ambrato. **es** Estructura metálica, difusores de cristal ámbar. **pl** Metalowe
 obramowanie, dyfuzory z bursztynowego szkła. **ru** Арматура из металла. Плафоны
 янтарного цвета выполнены из стекла.



 Gold Matt / G



▲
MOD012WL-02G
 ⚡ 2xG9 28W
 H: 650, W: 175, L: 135 mm,
 □ h=270

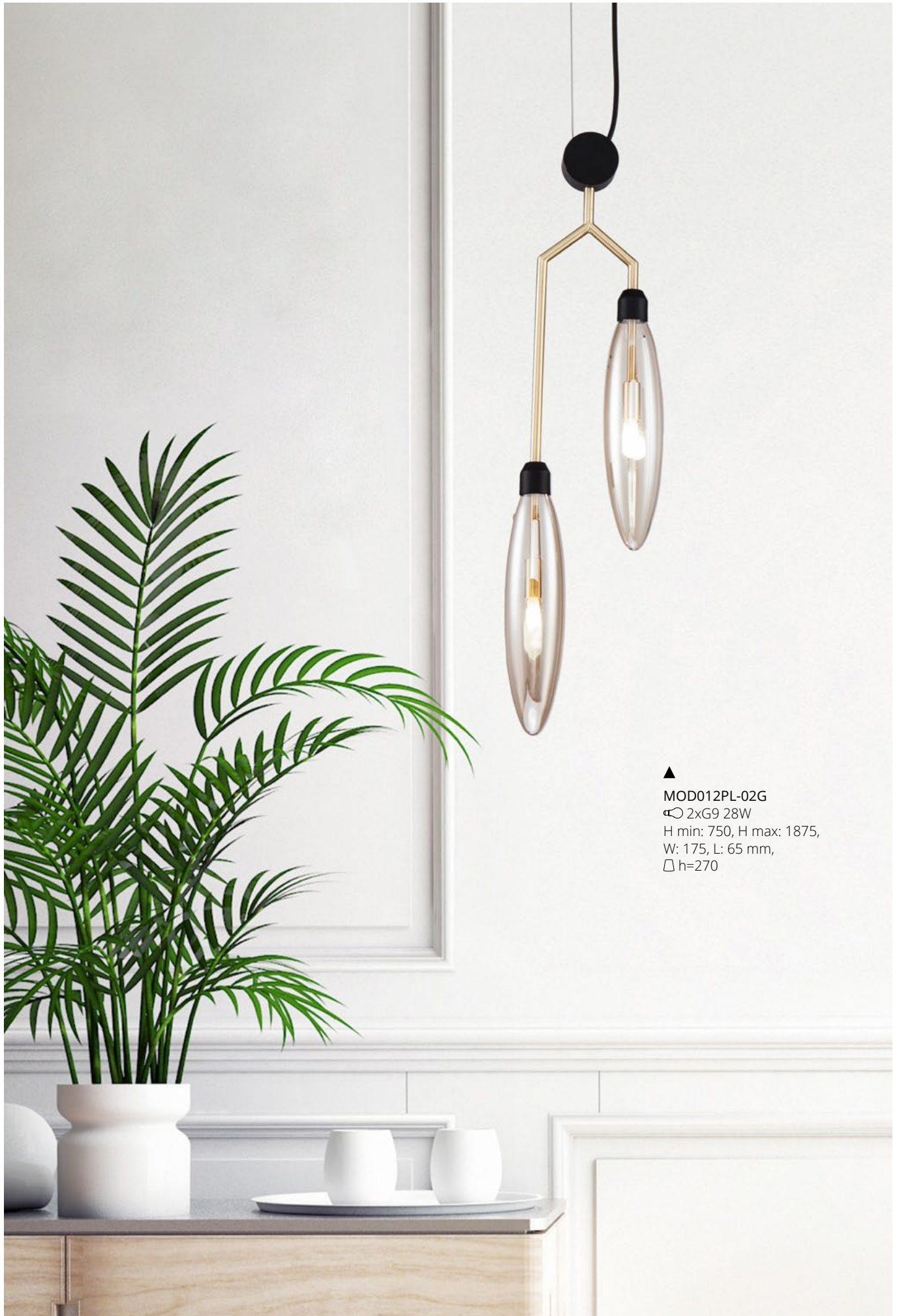

▲
MOD012PL-02G
☞ 2xG9 28W
H min: 750, H max: 1875,
W: 175, L: 65 mm,
□ h=270



MOD003PL-L27WS

☞ LED 27W

H min: 380, H max: 1380,

W: 820, L: 80 mm,

2100 Lumen

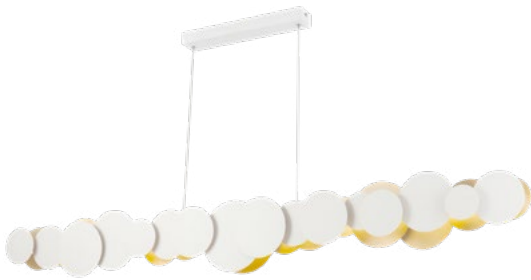

MOD003PL-L54WG

☞ LED 54W

H min: 380, H max: 1380,

W: 1500, L: 80 mm,

4100 Lumen



MOD003PL-L54WS

☞ LED 54W

H min: 380, H max: 1380,

W: 1500, L: 80 mm,

4100 Lumen

CLOUD

en Metal frame with integrated LED module. **de** Metallrahmen mit integriertem LED Modul. **fr** Armature métallique, module LED intégré. **it** Struttura in metallo con modulo LED integrato. **es** Estructura metálica con módulo LED integrado. **pl** Metalowe obramowanie, zintegrowany moduł LED. **ru** Арматура из металла. Светильник с использованием LED-модуля.



☉ White and Silver / WS ☉ White with Gold / WG



▲
MOD003PL-L27WG
LED 27W
H min: 380, H max: 1380,
W: 820, L: 80 mm,
2100 Lumen



MOD013PL-04B/W

☞ 4xG9 25W

H min: 340, H max: 1840,

W: 435, L: 390 mm,

□ d=120

RING

en Metal frame. Frosted glass diffusers. **de** Metallrahmen. Diffusoren aus mattiertem

Glas. **fr** Armature métallique, diffuseur en verre dépoli. **it** Struttura in metallo.

Diffusori in vetro acidato. **es** Armazón de metal. Difusores de vidrio esmerilado.

pl Metalowe obramowanie. Dyfuzory z oszronionego szkła. **ru** Арматура из металла.

Плафоны из белого матового стекла.



○ White / W

● Black / B



MOD013PL-02B/W

☞ 2xG9 25W

H min: 520, H max: 2040,

W: 170, L: 120 mm,

□ d=120



MOD013PL-06B/W

⊙ 6xG9 25W

H min: 340, H max: 1840,

D: 580 mm,

□ d=120





◀
MOD221-PL-12-G
 ⚡ 12xE14 40W
 H min: 700, H max: 1400,
 W: 1100, L: 500 mm,
 □ d=150



◀
MOD221-WL-02-G
 ⚡ 2xE14 40W
 H: 360, W: 150, L: 330 mm,
 □ d=150



▲
MOD221-WL-01-G
 ⚡ 1xE14 40W
 H: 270, W: 150, L: 190 mm,
 □ d=150



▲
MOD221-PL-08-G
 ⚡ 8xE14 40W
 H min: 590, H max: 1290,
 W: 960, L: 570 mm,
 □ d=150

ERICH

en Metal frame with frosted glass diffusers. The stem consists of 3 parts (MOD221-PL). Adjustable (except MOD221-WL). **de** Metallrahmen mit matten Diffusoren aus Glas. Die Stange besteht aus 3 Teilen (MOD221-PL). Verstellbar (außer für MOD221-WL). **fr** Armature métallique, diffuseur en verre dépoli. Tige composée en 3 pièces (MOD221-PL). Ajustable (sauf pour MOD221-WL). **it** Struttura in metallo con diffusori in vetro acidato. Tige regolabile, costituita da 3 parti. **es** Estructura metálica con difusores de vidrio esmerilado. Tige regulable, constituida da 3 parti. **pl** Metalowa rama. Białe klosze z matowego szkła. Mocowanie składa się z trzech części, dzięki czemu wysokość lampy można regulować (nie dotyczy kinkietów MOD221-WL). **ru** Арматура из металла. Плафоны выполнены из матового стекла. Основание состоит из 3-х частей (MOD221-PL). Возможность изменения высоты (кроме MOD221-WL).



● Nickel / N

● Brass / BS



▲
MOD221-PL-01-G
 ⚡ 1xE14 40W
 H min: 345, H max: 1805,
 D: 150 mm,
 □ d=150



◀
MOD221-FL-01-G
 ⚡ 1xE14 40W
 H: 1550, D: 250 mm,
 □ d=150,
 Class 2



▲
MOD221-TL-01-G
 ⚡ 1xE14 40W
 H: 650, W: 170, L: 215 mm,
 □ d=150,
 Class 2



▲
MOD221-PL-05-G
 ⚡ 5xE14 40W
 H min: 453, H max: 1493,
 W: 1200, L: 150 mm,
 □ d=150



▲
MOD221-PL-12-N
 ☞ 12xE14 40W
 H min: 700, H max: 1400,
 W: 1100, L: 500 mm,
 □ d=150



▲
MOD221-PL-01-N
 ☞ 1xE14 40W
 H min: 345, H max: 1805,
 D: 150 mm,
 □ d=150



◀
MOD221-WL-02-N
 ☞ 2xE14 40W
 H: 360, W: 150, L: 330 mm,
 □ d=150



▲
MOD221-WL-01-N
 ☞ 1xE14 40W
 H: 270, W: 150, L: 190 mm,
 □ d=150



◀
MOD221-FL-01-N
 ☞ 1xE14 40W
 H: 1550, D: 250 mm,
 □ d=150,
 Class 2



▲
MOD221-TL-01-N
 ☞ 1xE14 40W
 H: 650, W: 170, L: 215 mm,
 □ d=150,
 Class 2



▲
MOD221-PL-8-N
⦿ 12xE14 40W
H min: 700, H max: 1400,
W: 1100, L: 500 mm,
□ d=150





◀
MOD048PL-09G
 ⚡ 9xE14 40W
 H max: 615, Hmix: 920,
 D: 1315 mm,
 □ h=150



◀
MOD048WL-02G
 ⚡ 2xE14 40W
 H: 420, W: 175, L: 440 mm,
 □ h=150



▲
MOD048PL-03G
 ⚡ 3xE14 40W
 H max: 500, Hmix: 1500,
 D: 333 mm,
 □ h=150

NOSTALGIA

en Metal frame with frosted glass diffusers. **de** Metallrahmen mit Diffusoren aus Milchglas.
fr Structure en métal avec diffuseurs en verre dépoli. **it** Struttura in metallo, diffusori
 in vetro bianco acidato. **es** Estructura de metal. Tulipas de vidrio mate. **pl** Metalowe
 obramowanie z dyfuzorami z matowego szkła. **ru** Арматура из металла. Плафоны
 выполнены из матового стекла.



● Gold Matt / G



▲
MOD048PL-06G
⊕ 6x E14 40W
H max: 510, Hmix: 815,
D: 1000 mm,
□ h=150



▲
MOD548PL-25G/CH
 ⚡ 25xG9 28W
 H min: 238, H max: 1354,
 D: 690 mm,
 □ d=100 / h=95
 Gold – Shining Gold



▲
MOD547WL-13G/CH
 ⚡ 13xG9 28W
 H: 220, W: 950, L: 220 mm,
 □ d=100 / h=95
 Gold – Shining Gold



▲
MOD547WL-05G/CH
 ⚡ 5xG9 28W
 H: 240, W: 230, L: 380 mm,
 □ d=100 / h=95
 Gold – Shining Gold



▲
MOD547WL-09G/CH
 ⚡ 9xG9 28W
 H: 220, W: 665, L: 220 mm,
 □ d=100 / h=95
 Gold – Shining Gold

DALLAS

en Gold or chrome metal frame. Glass diffusers. 2 different gold finishes: MOD545 - matte, MOD547 - shining. **de** Gold- oder chromfarbener Metallrahmen. Diffusoren aus Glas. 2 unterschiedliche Optik: MOD545 . matt, MOD547 poliert. **fr** Armature métallique dorée ou chrome. Diffuseur en verre. 2 finitions différentes: MOD545 – mat, MOD547 - poli. **it** Struttura in metallo dorata o cromata. Diffusori in vetro. MOD545 oro finitura opaca, MOD547 oro finitura lucida. **es** Estructura de metal dorado o cromado. Difusores de vidrio. Estructura dre 2 colores de oro: MOD545 - mate, MOD547 - sanitado. **pl** Rama dostępna w dwóch kolorach: złoty i chrom. Szklane klosze. Dwa rodzaje złotego wykończenia. Modele MOD545 w kolorze matowego złota, a modele MOD547 w kolorze błyszczącego złota. **ru** Арматура из металла 2-х цветов: золото и хром. Плафоны из стекла. 2 вида золотого цвета арматуры: MOD545 - матовый, MOD547 - глянцевый.



● Chrome / CH ● Gold / G



▲
MOD545PL-24CH/G
 ⌀ 24xG9 28W
 H min: 900, H max: 1465,
 D: 650 mm,
 ▢ d=100 / h=95
 Gold - Matte Gold



◀
MOD547PL-25G/CH
 ⌀ 25xG9 28W
 H min: 228, H max: 1339,
 W: 238, L: 1235 mm,
 ▢ d=100 / h=95
 Gold - Shining Gold



◀
MOD545PL-12CH/G
 ⌀ 12xG9 28W
 H: 200, D: 600 mm,
 ▢ d=100 / h=95
 Gold - Matte Gold



◀
MOD545PL-20CH/G
 ⌀ 20xG9 28W
 H: 250, D: 750 mm,
 ▢ d=100 / h=95
 Gold - Matte Gold



◀
MOD009PL-05N
 ⚡ 5x E14 40W
 H min: 525, H max: 1225,
 W: 830, L: 365 mm,
 □ d1=110 / d2=200 / h=170



◀
MOD009WL-01N
 ⚡ 1x E14 40W
 H: 205, W: 160, L: 186 mm,
 □ d1=95 / d2=160 / h=135



▲
MOD009TL-01N
 ⚡ 1x E14 40W
 H: 618, D: 200 mm,
 □ d1=110 / d2=200 / h=165,
 Class 2

TARRASA

en Metal frame, nickel finish. Fabric covered shades. **de** Metallrahmen, vernickelt. Stoffbezogene Lampenschirme. **fr** Support en métal, éléments décoratifs en verre. Abat-jours couverts de tissu. **it** Struttura in metallo, finitura in nichel. Paralumi rivestiti in tessuto. **es** Estructura metálica, acabado en níquel. Tonos cubiertos de tela. **pl** Metalowe obramowanie, wykończenie niklowane. Klosze pokryte tkaniną. **ru** Арматура из металла, цвет - никель. Абажуры из ткани.



● Nickel / N



▲
MOD527PL-06N
 ⚡ 6x E14 40W
 H: 490, D: 740 mm,
 □ d=170 / h=120



◀
MOD527WL-01N
 ⚡ 1x E14 40W
 H: 260, W: 170, L: 225 mm,
 □ d=170 / h=120

LINCOLN

en Metal frame with decorative glass elements. Shades covered in fabric. **de** Metallrahmen mit dekorativen Elementen aus Glas. Lampenschirme mit Stoffbezug. **fr** Support en métal avec éléments décoratifs en verre. Abat-jours en tissu. **it** Struttura in metallo con elementi decorativi in vetro. Paralumi rivestiti in tessuto. **es** Estructura metálica con elementos decorativos de vidrio. Pantallas de tela. **pl** Metalowe obramowanie z dekoracyjnymi elementami szklanymi. Klosze pokryte tkaniną. **ru** Арматура из металла. Декоративные элементы из стекла. Абажур из ПВХ покрыт тканью.



● Nickel / N



MOD323-PL-01-W

☞ 1xE27 40W

H min: 970, H max: 1270,

D: 450 mm,

☐ d1=350 / d2=450 / h=270

MONIC

en Metal frame. Telescopic tube enables to adjust base height. PVC lampshade is covered with cloth.

de Dezenze Hängeleuchte. PVC-Lampenschirm mit Stoffbezug. **fr** Armature métallique. Abat-jour en PVC recouvert de tissu. **it** Struttura in metallo, altezza regolabile. Diffusore in PVC rivestito in tessuto. **es** Estructura de metal. El tubo telescópico permite ajustar la altura de la base. Pantalla de PVC revestida de tela. **pl** Metalowe obramowanie. Teleskopowa rura umożliwia regulację wysokości podstawy. Klosz z PCV pokryty jest tkaniną. **ru** Каркас из металла. Телескопическая трубка позволяет регулировать высоту основания. Абажур из ПВХ покрыт тканью.



☉ White-Chrome / W-CH ● Black-Chrome / B-CH



MOD323-TL-01-B/W

☞ 1xE27 40W

H min: 500, H max: 700,

D: 350 mm,

☐ d1=280 / d2=350 / h=280



▲
MOD617CL-04GR
 ⚡ 3xE27 60W
 H: 175, D: 520 mm,
 □ d=520 / h=175



▲
MOD613CL-04GR
 ⚡ 3xE27 60W
 H: 175, D: 520 mm,
 □ d=520 / h=175

BERGAMO

en Metal frame, fabric diffusers. **de** Metallrahmen, Diffusoren aus Stoff. **fr** Armature métallique, diffuseur en tissu. **it** Struttura in metallo con diffusore in tessuto. **es** Estructura metálica, difusores de tela. **pl** Metalowe obramowanie, dyfuzor z tkaniny. **ru** Арматура из металла. Абажур из ПВХ покрыт тканью.



● Chrome / CH



◀
MOD029-PL-01-W
 ⚡ 1xE27 60W
 H min: 470, H max: 1200,
 D: 350 mm,
 □ d1=300 / d2=350 / h=250



▲
MOD029-TL-01-W
 ⚡ 1xE27 40W
 H: 620, D: 350 mm,
 □ d1=300 / d2=350 / h=250

LANTERN

en Acid-etched glass diffuser, metal frame with wooden element. **de** Diffusor aus säuregeätztem Glas, Metallrahmen mit Element aus Holz. **fr** Diffuseur en verre dépoli à l'acide, armature métallique avec éléments en bois. **it** Diffusore in vetro acidato, struttura in metallo con elemento in legno. **es** Difusor de cristal grabado al ácido, estructura metálica con elemento de madera. **pl** Dyfuzor z oszronionego szkła, metalowe obramowanie z elementem drewnianym. **ru** Каркас из металла с деревянным элементом. Использование трафаретного узора.



○ White / W



▲
 MOD981-PL-01-B
 1xE14 40W
 H min: 350, H max: 1810,
 D: 170 mm,
 □ d1=80 / d2=170 / h=185

MAJORCA

en Polyresin frame. Organza lampshade. **de** Pendelleuchte mit Polyresinrahmen. Lampenschirm aus feinstem Organza. **fr** Armature en polyrésine. Abat-jour en organza. **it** Struttura in poliresina. Diffusore in organza. **es** Estructura de poliresina. Pantalla de organza. **pl** Rama z żywicy poliestrowej. Abażur wykonany z organzy. **ru** Арматура из полирезина. Абажур из органзы.



● Black / B



▲
MOD030PL-06GR
 ⚡ 6x E14 40W
 H min: 1696, H max: 2046,
 D: 940 mm,
 ▢ d=175 / h=70



◀
MOD030PL-05GR
 ⚡ 5x E14 40W
 H min: 286, H max: 1846,
 D: 490 mm,
 ▢ d=175 / h=70



◀
MOD030PL-01GR
 ⚡ 1x E14 40W
 H min: 286, H max: 1846,
 D: 175 mm,
 ▢ d=175 / h=70

VOID

en Metal frame. Metal and acrylic lampshade. Adjustable height of lamps. **de** Metallrahmen. Lampenschirm aus Metall und Acryl. Einstellbare Höhe der Lampen. **fr** Armature en métal. Hauteur ajustable. Abat-jours en métal et acrylique. **it** Struttura in metallo. Diffusore in metallo e acrilico. Altezza regolabile. **es** Estructura de metal. Altura variable. Tulipas de metal y acrílico. **pl** Metalowe obramowanie. Klosz metalowy i akrylowy. Regulowana wysokość. **ru** Арматура из металла. Плафон из металла и акрила. Регулируемая высота светильников.



● Grey / GR



▲
MOD541PL-01G/W
 1xE27 40W
 H min: 496, H max: 1936,
 D: 500 mm,
 □ d=200 / h=200



▲
MOD543PL-01W
 1xG9 28W
 H min: 401, H max: 1841,
 D: 380 mm,
 □ d=150 / h=100



▲
MOD542TL-01G/W
 1xG9 28W
 H: 210, D: 250 mm,
 □ h=100,
 Class 2

POLLY

en Metal frame. Decorative diffuser made of white matt glass. **de** Leuchte aus geschwungenen Metallstäbchen. Dekorativer Lampenschirm aus weißem Opakglas. **fr** Structure métallique. Abat-jour décoratif en verre blanc mat. **it** Struttura in metallo e diffusore in vetro bianco opaco. **es** Estructura de varillas de metal. Pantalla decorativa de vidrio blanco mate. **pl** Metalowe obramowanie. Dekoracyjny dyfuzor wykonany z białego matowego szkła. **ru** Каркас из металлических прутьев. Декоративный плафон из белого матового стекла.



○ White / W

◐ White with Gold / WG

◑ Black and Gold / BG



▲
MOD542PL-01W
☞ 1xG9 28W
H min: 270, H max: 1710,
D: 250 mm,
□ h=100



▲
MOD239-05-B
 ⚡ 5xE14 40W
 H min: 345, H max: 1510,
 D: 500 mm,
 □ d1=500 / d2=412 / h=200

BRAVA LAMPADA

en Metal frame with wooden elements. **de** Metallrahmen mit Elementen aus Holz. **fr** Armature métallique avec éléments en bois. **it** Struttura in metallo con elementi in legno. **es** Estructura metálica con elementos de madera. **pl** Metalowe obramowanie z elementami drewnianymi. **ru** Арматура из металла и деревянных элементов.



● Nickel / N



▲
MOD239-11-B
 ⚡ 1xE14 40W
 H min: 445, H max: 1565,
 D: 105 mm,
 □ d=105 / h=239



MOD544PL-01B

1xG9 28W

H min: 466, H max: 1746,

D: 180 mm,

□ d=100 / h=100



MOD544WL-01B

1xG9 28W

H: 410, W: 180, L: 148 mm,

□ d=100 / h=100,

Class 2



MOD544TL-01B

1xG9 28W

H: 410, D: 180 mm,

□ d=100 / h=100,

Class 2

INDIANA

en Decorative metal frame with frosted glass diffusers and leather strap. **de** Dekorativer Metallrahmen mit mattierten Diffusoren aus Glas und Lederband. **fr** Armature décorative métallique, diffuseur en verre dépoli ance en cuir. **it** Struttura decorativa in metallo con diffusori in vetro acidato e cinghia in pelle. **es** Estructura decorativa de metal con difusores de vidrio esmerilado y correa de piel. **pl** Metalowe obramowanie ozdobne z dyfuzorami z oszronionego szkła i skórzanym paskiem. **ru** Арматура из металла. Плафон выполнен из матового стекла, украшен кожаным ремешком.



● Black / B

● Black and Gold / BG



▲
MOD614PL-01BS
 ⚡ 1xE27 40W
 H min: 240, H max: 1700,
 D: 175 mm,
 □ d=175 / h=165



◀
MOD614FL-02BS
 ⚡ 2xE27 40W
 H: 1620, W: 450, L: 450 mm,
 □ d=175 / h=165,
 Class 2



TRENTO

en Perforated metal lampshade with black decorative elements. Metal frame. **de** Lampenschirm aus perforiertem Metall mit schwarzen dekorativen Elementen. Metallrahmen. **fr** Abat-jour en métal perforé avec élément décoratif noir. Armature métallique. **it** Paralume in metallo traforato con elementi decorativi neri. Struttura in metallo. **es** Pantalla de metal perforado con elementos decorativos negros. Marco de metal. **pl** Perforowany metalowy abażur z czarnymi elementami dekoracyjnymi. Metalowe obramowanie. **ru** Арматура из металла. Декоративный плафон из перфорированного металла с черными декоративными элементами.



● Black / B



▲
 MOD142-WL-01-GR/N/B/BS/W
 ☞ 1xE27 40W
 H: 210, W: 140, L: 385 mm,
 □ d=140 / h=160



▲
 MOD142-TL-01-N/B/GR/W
 ☞ 1xE27 40W
 H: 520, W: 175, L: 470 mm,
 □ d=140 / h=160,
 Class 2

DOMINO

en Metal lamp, adjustable. Available in 5 colours. **de** Leuchte aus Metall, verstellbar. Erhältlich in 5 Farben. **fr** Armature métallique, amovible. **it** Lampada in metallo, regolabile. Disponibile in 5 colori. **es** Lámpara de metal, ajustable. Disponible en 5 colores. **pl** Lampa metalowa, regulowana. Dostępna w 5 kolorach. **ru** Арматура из металла. Положение плафона регулируется. Модель представлена в 5-ти цветах.



○ White / W

● Black / B

○ Nickel / N

● Brass / BS

● Grey / GR



◀ MOD619PL-01GR

☉ 1xE14 40W
H: 1200, D: 132 mm,
□ d1=99 / d2=132 / h=122



MOD619TL-01GR

☉ 1xE14 40W
H: 315, W: 170, L: 300 mm,
□ d1=79 / d2=136 / h=201,
Class 2

NOVARA

en Metal structure and diffusers made of matt glass. **de** Moderne Leuchte mit Lampenschirmfassungen und Rahmen aus Metall und Opalglasschirmen.

fr Armature et enveloppes d'abat-jour en métal. Abat-jour en verre mat.

it Struttura in metallo, diffusore in vetro opaco. **es** Estructura y soportes de las pantallas realizados en metal. Pantallas de vidrio mate. **pl** Metalowa konstrukcja i dyfuzory wykonane z matowego szkła. **ru** Арматура и скрывающие плафоны колбы из металла. Матовые плафоны из стекла.



● Grey / GR



MOD611TL-01GR

☉ 1xE14 40W
H: 515, W: 200, L: 420 mm,
□ d1=79 / d2=136 / h=227,
Class 2



◀
MOD618TL-01W
 1xE27 60W
 H: 430, W: 305, L: 150 mm,
 □ d1=120 / d2=150 / h=150,
 Class 2



◀
MOD618WL-01W
 1xE27 60W
 H: 425, W: 250, L: 150 mm,
 □ d1=120 / d2=150 / h=150,
 Class 2

KARL

en Metal body, fabric covered lampshade. **de** Korpus aus Metall, Lampenschirm mit Stoffbezug. **fr** Corps métallique, abat-jour en tissu. **it** Corpo in metallo, paralume rivestito in tessuto. **es** Cuerpo de metal, pantalla cubierta de tela. **pl** Obudowa metalowa, klosz pokryty tkaniną. **ru** Каркас из металла. Абажур из ПВХ покрыт тканью.



○ White / W



▲
MOD184-PL-04-CH
 4xE27 60W
 H min: 412, H max: 1312,
 D: 500 mm,
 □ d=500 / h=212

GELID

en Metal frame, chrome finish. Crystal slabs diffuser. **de** Metallrahmen, verchromt. Diffusor aus Kristallscheiben. **fr** Support en métal, finition chromée. Diffuseur en plaques de cristal. **it** Struttura in metallo, finitura cromata. Diffusore in lastre di cristallo. **es** Estructura metálica, acabado cromado. Difusor de plaquetas de cristal. **pl** Metalowe obramowanie, chromowane. Dyfuzor z płytek kryształowych. **ru** Арматура из металла, цвет - хром. Плафон выполнен из хрустальных пластин, скрепленных между собой.



● Chrome / CH



▲
MOD184-WL-01-CH
☞ 1xG9 40W
H: 212, W: 147, L: 100 mm,
□h=212



◀
MOD184-PL-01-CH
☞ 1xE27 60W
H min: 350, H max: 1312,
D: 302 mm,
□d=302 / h=212



▲
MOD043PL-06CH
 ⚡ 6xE14 60W
 H min: 260, H max: 710,
 D: 517 mm



◀
MOD043PL-04CH
 ⚡ 4xE14 60W
 H min: 260, H max: 710,
 D: 380 mm



PUNTES

en Metal frame. Diffuser made of glass slabs. Adjustable height. **de** Metallrahmen. Dekorative Anhänger. Verstellbare Höhe. **fr** Armature en métal. Pendentifs décoratifs. Hauteur ajustable. **it** Struttura in metallo, diffusore in lastre di vetro. Altezza regolabile. **es** Estructura de metal. Colgantes decorativas. Altura ajustable. **pl** Metalowe obramowanie. Dyfuzor wykonany z płyt szklanych. Regulowana wysokość. **ru** Арматура из металла. Декоративные подвески. Регулируемая высота.



● Chrome / CH

▲
MOD043WL-01CH
 ⚡ 1xE14 60W
 H: 160, W: 153, L: 256 mm



▲
DIA002PL-05CH
⌀ 5x E14 60W
H min: 600; H max: 1200,
W: 1000, L: 180 mm

EMPRESS

en Metal frame, chrome finish. Crystal pendants. Adjustable height. **de** Metallrahmen, verchromt. Anhänger aus Kristall. Höhenverstellbar. **fr** Support en métal, finition chromée. Pendentifs en cristal. Hauteur réglable. **it** Struttura in metallo, finitura cromata. Pendenti in cristallo. Altezza regolabile. **es** Estructura metálica, acabado cromado. Colgantes de cristal. Altura ajustable. **pl** Metalowe obramowanie, chromowane. Kryształowe wisioriki. Regulowana wysokość. **ru** Арматура из металла, цвет - хром. Декоративные подвески из хрусталя. Регулируемая длина.



● Chrome / CH



◀
DIA600-07-N/G
7x E14 60W
H min: 430, H max: 680,
W: 933, L: 240 mm



◀
DIA600-02-G/N
2x E14 60W
H: 350, W: 405, L: 140 mm

TOILS

en Metal frame, chrome finish. Crystal pendants. Adjustable. Gold or nickel finish available. **de** Metallrahmen, verchromt. Anhänger aus Kristall. Höhenverstellbar. Erhältlich in Gold oder Nickel. **fr** Monture en métal, finition chromée. Pendentifs en cristal. Hauteur réglable. Finition or ou nickel disponible. **it** Struttura in metallo, finitura cromata. Pendenti in cristallo. Altezza regolabile. Disponibile con finiture in oro o nichel. **es** Estructura metálica, acabado cromado. Colgantes de cristal. Altura ajustable. Acabado en oro o níquel disponible. **pl** Metalowe obramowanie, chromowane. Kryształowe wisiorki. Regulowana wysokość. Dostępne wykończenie złote lub niklowane. **ru** Арматура из металла. Декоративные подвески из хрусталя. Регулируемая длина. Модель доступна в 2-х цветах: золото, никель.



● Nickel / N

● Gold / G





▲
 MOD217-50-N
 ⚡ 12xG9 40W
 H: 650, W: 500, L: 500 mm



◀
 MOD217-40-N
 ⚡ 5xG9 40W
 H: 540, W: 400, L: 400 mm

SWIRL

en Square metal frame, crystal pendants. **de** Quadratischer Metallrahmen, Anhänger aus Kristall.
fr Support en métal carré, pendentifs en cristal. **it** Struttura quadrata in metallo, pendenti
 in cristallo. **es** Estructura metálica cuadrada, colgantes de cristal. **pl** Metalowe obramowanie
 kwadratowe, kryształowe wisiorki. **ru** Четырехугольный каркас из металла. Декоративные
 подвески из хрусталя.



● Nickel / N



◀
MOD201PL-08N
 ⚡ 8xE14 40W
 H min: 540, H max: 1540,
 W: 855, L: 265 mm,
 □ h=240



◀
MOD201PL-07N
 ⚡ 7xE14 40W
 H min: 540, H max: 1540, D:
 800 mm,
 □ d=800 / h=240



▲
MOD201PL-05N
 ⚡ 5xE14 40W
 H min: 540, H max: 1540,
 D: 600 mm,
 □ d=600 / h=240

CEREZO

en Metal frame, decorative glass slabs. **de** Metallrahmen. Lampenschirm aus miteinander verbundenen Glasplatten. **fr** Armature en métal. Abat-jours fait de plaques de verre fixées entre elles. **it** Struttura in metallo. Diffusore in lastre di vetro. **es** Estructura de metal. Tulipa de las placas de vidrio fijadas.

pl Metalowe obramowanie. Klosz wykonany z połączonych płyt szklanych. **ru** Каркас из металла. Плафон выполнен из стеклянных пластин, скрепленных между собой.



● Chrome / CH



H186-PL-01-40W-BS

LED 40W

H min: 250, H max: 1600,

W: 800, L: 90 mm,

2253 Lumen



H186-PL-01-53W-BS

LED 53W

H min: 250, H max: 1600,

W: 1150, L: 90 mm,

2270 Lumen

GLETSCHER

en Metal frame, brass finish. LED module. Decorative crystals. **de** Metallrahmen, Messing-Ausführung. LED Modul. Dekorative Kristalle. **fr** Support en métal, finition en laiton. Module LED. Cristaux décoratifs. **it** Struttura in metallo, finitura in ottone. Modulo LED. Cristalli decorativi. **es** Estructura metálica, acabado en latón. Módulo LED Cristales decorativos. **pl** Metalowe obramowanie, wykończenie mosiężne. Moduł LED. Kryształ dekoracyjny. **ru** Арматура из металла, цвет - латунь. Декоративные кристаллы. LED-модуль.



Brass / BS



▲
H186-PL-01-46W-BS
 LED 46W
 H min: 250, H max: 1600,
 D: 600 mm, 1467 Lumen



▲
H186-PL-01-61W-BS
 LED 61W
 H min: 350, H max: 1800,
 D: 850 mm, 1621 Lumen



▲
H186-PL-01-73W-BS
 LED 73W
 H min: 400, H max: 1800,
 D: 1100 mm, 2642 Lumen



▲
DIA902-06-N
⚡ 6xE14 60W
H: 160, D: 490 mm



◀
DIA902-04-N
⚡ 4xE14 60W
H: 120, D: 400 mm

BROCHE

en Round metal frame. Crystals of different sizes. **de** Runder Metallrahmen. Kristalle in verschiedenen Größen. **fr** Support en métal rond. Cristaux de différentes tailles. **it** Struttura in metallo tonda. Cristalli di diverse dimensioni. **es** Estructura redonda de metal. Cristales de diferentes tamaños. **pl** Metalowe obramowanie okrągłe. Kryształy o różnych rozmiarach. **ru** Круглый каркас из металла. Хрустальные подвески различных размеров.



● Nickel / N



▲
DIA005CL-10CH
⊕ 10xE14 60W
H: 250, W: 600, L: 600 mm



▲
DIA005CL-06CH
⊕ 6xE14 60W
H: 250, W: 450, L: 450 mm

DUNE

en Metal frame. Decorative pendants. **de** Metallrahmen. Dekorative Anhänger. **fr** Armature en métal. Pendentifs décoratifs. **it** Struttura in metallo. Pendenti decorativi. **es** Estructura de metal. Colgantes decorativos. **pl** Metalowe obramowanie. Ozdobne wisiorki. **ru** Арматура из металла. Декоративные подвески.



● Chrome / CH



◀
DIA008PL-05CH
 ⚡ 5x E14 40W
 H min: 572, H max: 802,
 D: 700 mm,
 □ d=150 / h=110



◀
DIA008TL-01CH
 ⚡ 1x E27 40W
 H: 445, D: 250 mm,
 □ d=250 / h=170,
 Class 2



◀
DIA008WL-01CH
 ⚡ 1x E14 40W
 H: 310, W: 150, L: 190 mm,
 □ d=150 / h=110

TALENTO

en Metal frame. Arms are completed with glass elements. PVC lampshade is covered with white cloth. **de** Metallrahmen. Die Armen werden mit Glaselementen beschmückt. PVC-Lampenschirm ist mit einem weißen Tuch überzogen. **fr** Armature en métal. Les bras sont complétés d'éléments en verre. L'abat-jour en PVC est recouvert d'un tissu blanc. **it** Struttura in metallo con elementi in vetro. Diffusore in PVC rivestito con tessuto bianco. **es** Estructura de metal. Los brazos se complementan con elementos de vidrio. Pantalla de PVC cubierta con tela blanca. **pl** Metalowe obramowanie. Ramiona zakończone są elementami szklanymi. Klosz z PCV pokryty jest białą tkaniną. **ru** Арматура из металла. Рожки дополнены стеклянными элементами. Абажур из ПВХ покрыт белой тканью.



● Chrome / CH



▲
DIA008PL-07CH
☞ 7xE14 40W
H min: 572, H max: 802,
D: 800 mm,
☐ d=150 / h=110





MOD044-PL-03-N

3xE14 40W

H min: 320, H max: 1000,

W: 520, L: 140 mm,

d1=90 / d2=100 / h=170

BLUES

en Metal frame, glass diffusers in transparent (MOD044) or fume (MOD033) glass. Decorative crystal pendants. **de** Metallrahmen, Glasdiffusoren (MOD044) aus Klar- oder (MOD033) Rauchglas. Dekorative Anhänger aus Kristall. **fr** Armature métallique, diffuseur en verre transparent (MOD044) ou fumé (MOD033). Pendants décoratifs en cristal. **it** Struttura in metallo, diffusori in vetro trasparente (MOD044) o fumé (MOD033). Pendenti decorativi in cristallo. **es** Construcción metálica, difusores de material transparente (MOD044) o vidrio (MOD033) ahumado. Colgantes decorativos de cristal. **pl** Metalowe obramowanie, dyfuzory szklane przezroczyste (MOD044) lub opalane (MOD033). Dekoracyjne wisioriki kryształowe. **ru** Арматура из металла. Плафоны из стекла 2-х цветов: прозрачного (MOD044) и дымчатого (MOD033). Декоративные подвески из хрусталя.

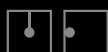

● Nickel / N



▲
MOD044-PL-01-N
 ⚡ 1xE14 40W
 H min: 320, H max: 1000,
 D: 140 mm,
 □ d1=90 / d2=100 / h=170

▲
MOD033-PL-03-N
 ⚡ 3xE14 40W
 H min: 310, H max: 1000,
 W: 520, L: 140 mm,
 □ d1=90 / d2=100 / h=170



▲
MOD033-PL-01-N
 ⚡ 1xE14 40W
 H min: 310, H max: 1000,
 D: 140 mm,
 □ d1=90 / d2=100 / h=170



◀
MOD044-WL-01-N
 ⚡ 1xE14 40W
 H: 250, W: 140, L: 210 mm,
 □ d1=70 / d2=90 / h=170



◀
MOD033-WL-01-N
 ⚡ 1xE14 40W
 H: 250, W: 140, L: 210 mm,
 □ d1=90 / d2=100 / h=170



◀
P364PL-01G
 ⚡ 1xE27 60W
 H min: 300, H max: 1770,
 D: 520 mm,
 □ d=150



◀
P364PL-01B
 ⚡ 1xE27 60W
 H min: 300, H max: 1770,
 D: 520 mm,
 □ d=150

PLEC

en Decorative metal frame with frosted glass diffusers. **de** Dekorativer Metallrahmen mit mattierten Diffusoren aus Glas. **fr** Armature décorative métallique, diffuseur en verre dépoli. **it** Struttura decorativa in metallo con diffusori in vetro acidato. **es** Estructura metálica decorativa con difusores de vidrio esmerilado. **pl** Metalowe obramowanie ozdobne z dyfuzorami z oszronionego szkła. **ru** Декоративная арматура из металла. Плафон из белого матового стекла.



● Black / B

● Gold / G



◀
P361PL-01G
 ⚡ 1xG9 25W
 H min: 405, H max: 1680,
 D: 120 mm,
 □ d=120



◀
P362PL-01G
 ⚡ 1xE27 40W
 H min: 490, H max: 1700,
 D: 150 mm,
 □ d=150



◀
P363PL-01G
 ⚡ 1xE27 40W
 H min: 595, H max: 1760,
 D: 200 mm,
 □ d=200

TELFORD

en Decorative metal frame with frosted glass diffusers. **de** Dekorativer Metallrahmen mit mattierten Diffusoren aus Glas. **fr** Armature décorative métallique, diffuseur en verre dépoli. **it** Struttura decorativa in metallo con diffusori in vetro acidato. **es** Estructura metálica decorativa con difusores de vidrio esmerilado. **pl** Metalowe obramowanie ozdobne z dyfuzorami z oszronionego szkła. **ru** Декоративная арматура из металла. Плафон из белого матового стекла.



● Gold / G





◀
P001PL-01BZ
 1xE27 60W
 H min: 400, H max: 1500,
 D: 297 mm,
 □ d=297 / h=299



◀
P002PL-01BZ
 1xE27 60W
 H min: 534, H max: 1634,
 D: 223 mm,
 □ d=233 / h=434



◀
P003PL-01BZ
 1xE27 60W
 H min: 434, H max: 1534,
 D: 215 mm,
 □ d=215 / h=334

STONE

en Metal frame, amber glass diffuser. Adjustable height. **de** Metallrahmen, Bernsteinfarbige Diffusoren. Höhenverstellbar. **fr** Support en métal, diffuseur en verre ambré. Hauteur réglable. **it** Struttura in metallo, diffusore in vetro ambrato. Altezza regolabile. **es** Estructura metálica, difusor de cristal ámbar. Altura ajustable. **pl** Metalowe obramowanie, dyfuzor szklany w kolorze bursztynu. Regulowana wysokość. **ru** Арматура из металла. Плафон из стекла янтарного цвета. Регулируемая длина светильников.



● Bronze / BZ



◀
P012-PL-01-N
☉ 1xE14 40W
H min: 205, H max: 1000,
D: 150 mm,
□ d1=30 / d2=95 / h=135



◀
P012-PL-03-N
☉ 3xE14 40W
H min: 205, H max: 1000,
W: 570, L: 150 mm,
□ d1=30 / d2=95 / h=135

ICEBERG

en Metal frame. Chromo and glass diffusers with decorative crystal pendants (optional). **de** Metallrahmen. Diffusoren aus Chrom und Glas mit dekorativen Anhängern aus Kristall (optional). **fr** Armature métallique, diffuseur chrome et verre avec pendants décoratifs en cristal (optionnel). **it** Struttura in metallo. Diffusori in cromo e vetro con pendenti decorativi in cristallo (opzionale). **es** Estructura de metal. Difusores de cromo y vidrio con cristales decorativos (opcional). **pl** Metalowe obramowanie. Dyfuzory chromowo-szklane z dekoracyjnymi kryształami (opcjonalnie). **ru** Арматура из металла. Плафоны выполнены из стекла и металла, декорированы съемными подвесками из хрусталя.



● Nickel / N



◀
P244-PL-01-N
☉ 1xE14 40W
H min: 250, H max: 1400,
D: 160 mm,
□ d=160 / h=120



◀
P244-PL-03-N
☉ 3xE14 40W
H min: 250, H max: 1400,
W: 600, L: 120 mm,
□ d=160 / h=120

HAZE

en Metal frame, smoked glass diffusers. Decorative crystal pendants (optional). **de** Metallrahmen, Diffusoren aus Rauchglas. Dekorative Anhänger aus Kristall (optional). **fr** Armature métallique, diffuseur verre fumé. Pendants décoratifs en cristal (optionnel). **it** Struttura in metallo, diffusori in vetro fumé. Pendenti decorativi in cristallo (opzionale). **es** Estructura metálica, difusores de cristal fumé. Colgantes decorativos de cristal (opcional). **pl** Metalowe obramowanie, dyfuzory ze szkła opalanego. Dekoracyjne wisiorki kryształowe (opcjonalnie). **ru** Арматура из металла. Плафоны из матового стекла дымчатого цвета. Съемные декоративные подвески из хрусталя.



● Nickel / N

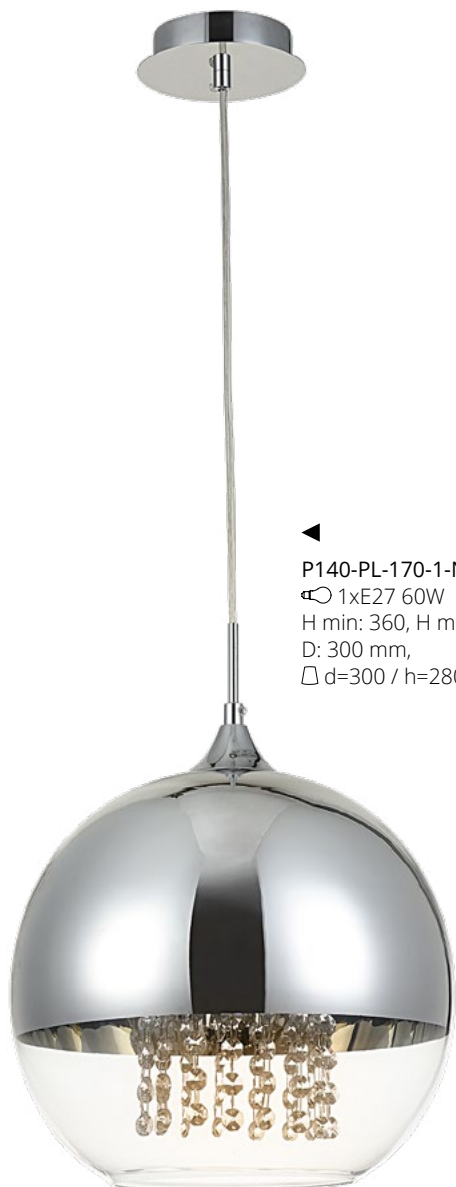

◀
P140-PL-170-1-N
 1xE27 60W
 H min: 360, H max: 1050,
 D: 300 mm,
 □ d=300 / h=280



◀
P140-PL-110-1-N
 1xE27 60W
 H min: 250, H max: 960,
 D: 200 mm,
 □ d=200 / h=175

FERMI

en Metal frame. Chromo and glass diffusers with decorative crystals (optional). **de** Metallrahmen. Diffusoren aus Chrom und Glas mit dekorativen Kristallen (optional). **fr** Armature métallique, diffuseur chrome et verre avec cristal décoratif (optionnel). **it** Struttura in metallo. Diffusori in cromo e vetro con cristalli decorativi (opzionale). **es** Estructura de metal. Difusores de cromo y vidrio con cristales decorativos (opcional). **pl** Metalowe obramowanie. Dyfuzory chromowoszklane z dekoracyjnymi kryształami (opcjonalnie). **ru** Арматура из металла. Плафоны выполнены из стекла и металла, декорированы съемными подвесками из хрусталя.



● Nickel / N



▲
P140-PL-170-5-N
5x E27 60W
H min: 330, H max: 950,
W: 910, L: 650 mm,
□ d=300 / h=280



▲
P225-PL-150-N
 ⚡ 4xE27 8W
 H min: 500, H max: 1500,
 W: 525, L: 525 mm,
 □ d=200



◀
P225-PL-200-N
 ⚡ 1xE27 8W
 H min: 480, H max: 1500,
 D: 200 mm,
 □ d=200



▲
P225-PL-300-N
 ⚡ 1xE27 8W
 H min: 490, H max: 1500,
 D: 300 mm,
 □ d=300

DEWDROP

en Metal base, matte glass diffusers. Led bulbs only. **de** Basis aus Metall, mattierte Diffusoren aus Glas. Nur LED-Lampen. **fr** Armature métallique, diffuseur verre mat. Seulement ampoules LED. **it** Base in metallo, diffusori in vetro opaco. Solo con lampadine a LED. **es** Base metálica, difusores de cristal mate. Solo bombillas led. **pl** Podstawa metalowa, dyfuzory szklane matowe. Tylko żarówki led. **ru** Основание из металла. Матовые плафоны из стекла. Допустимо использование только со светодиодными лампами.



● White / W



P225-PL-400-N

☉ 1xE27 8W

H min: 500, H max: 1500,

D: 400 mm,

□ d=400



P530PL-01W
 ⚡ 1xE27 60W
 H min: 300, H max: 1500,
 D: 150 mm,
 □ d1=140 / d2=150 / h=240



P531PL-01W
 ⚡ 1xE27 60W
 H min: 310, H max: 1510,
 D: 175 mm,
 □ d1=165 / d2=175 / h=250

WALTER

en Metal frame. Lampshades made of white matt glass with «water drops» effect. **de** Eleganter Metallrahmen mit Opakglas-Lampenschirm und «wet drops»-Effekt. **fr** Structure métallique. Abat-jour en verre blanc mat avec effet de gouttes d'eau. **it** Struttura in metallo. Diffusori in vetro bianco opaco con effetto «gocce d'acqua». **es** Estructura de metal. Pantallas de vidrio blanco mate con un acabado efecto «gotas de agua». **pl** Metalowe obramowanie. Klosze wykonane z białego matowego szkła z efektem «kropli wody». **ru** Каркас из металла. Плафоны из матового белого стекла с эффектом «мокрых капель».



○ White / W



▲
P229-PL-01-GR
☞ 1xE27 60W
H min: 580, H max: 1200,
D: 350 mm,
□ d1=245 / d2=350 / h=185



▲
P229-PL-01-W
☞ 1xE27 60W
H min: 580, H max: 1200,
D: 350 mm,
□ d1=245 / d2=350 / h=185

ELVA

en Metal frame with decorative diffuser. **de** Metallrahmen mit dekorativem Diffusor. **fr** Armature métallique avec diffuseur décoratif. **it** Struttura in metallo con diffusore decorativo. **es** Estructura metálica con difusor decorativo. **pl** Metalowe obramowanie z ozdobnym dyfuzorem. **ru** Арматура из металла. Декоративный плафон.



○ White / W

● Grey / GR



◀
MOD407-WL-01-N/W
 1xE14 40W
 H: 180, W: 140, L: 230 mm,
 □ d1=48 / d2=140 / h=132

DANIEL

en Metal frame. Glass diffuser. **de** Metallrahmen. Glasdiffusor. **fr** Structure en métal. Diffuseur en verre. **it** Struttura in metallo. Diffusore in vetro. **es** Estructura metálica. Difusor de vidrio. **pl** Metalowe obramowanie. Szklany dyfuzor. **ru** Каркас из металла. Рассеиватель из стекла.



○ White / W

● Nickel / N



▲
MOD407-PL-01-N/W
 1xE14 40W
 H min: 280, H max: 1520,
 D: 140 mm,
 □ d1=48 / d2=140 / h=132



▲
MOD238-PL-01-GN
 ☉ 1xE14 40W
 H min: 230, H max: 1430,
 D: 160 mm,
 □ d1=110 / d2=160 / h=230



◀
MOD238-PL-01-B
 ☉ 1xE14 40W
 H min: 230, H max: 1430,
 D: 160 mm,
 □ d1=110 / d2=160 / h=230



◀
MOD238-PL-01-BL
 ☉ 1xE14 40W
 H min: 230, H max: 1430,
 D: 160 mm,
 □ d1=110 / d2=160 / h=230



◀
MOD238-PL-01-TR
 ☉ 1xE14 40W
 H min: 230, H max: 1430,
 D: 160 mm,
 □ d1=110 / d2=160 / h=230

EUSTOMA

en Metal ceiling cup, glass diffusers available in 4 colours. Adjustable height. **de** Deckenbaldachin aus Metall, Diffusoren aus Glas. Erhältlich in 4 Farben. Höhenverstellbar. **fr** Coupelle en métal, diffuseur en verre, hauteur ajustable. **it** Calotta da soffitto in metallo, diffusori in vetro. Disponibile in 4 colori. Altezza regolabile. **es** Florón de metal, difusores de vidrio disponibles en 4 colores. Altura ajustable. **pl** Metalowa puszka sufitowa, dyfuzory szklane dostępne w 4 kolorach. Regulowana wysokość. **ru** Арматура и потолочная чаша из металла. Плафоны из стекла 4-х цветов. Регулируемая высота.



● Nickel / N



STAR

en Metal frame. Lampshades in the form of stars in various colours. **de** Pendelleuchte mit sternförmigen Lampenschirmen in verschiedenen Farben. **fr** Armature métallique. Abat-jours en forme d'étoiles de différentes couleurs. **it** Struttura in metallo. Diffusori a forma di stella disponibili in vari colori. **es** Estructura de metal. Pantallas de vidrio en forma de estrella disponibles en varios colores. **pl** Metalowe obramowanie. LAMPY w formie gwiazd w różnych kolorach. **ru** Каркас из металла. Плафоны в виде звезд различных цветов.



 Chrome / CH



▲
MOD242-PL-01-R
☞ 1xG9 28W
H min: 280, H max: 1440,
W: 200, L: 65 mm



▲
MOD242-PL-01-GN
☞ 1xG9 28W
H min: 280, H max: 1440,
W: 200, L: 65 mm



▲
MOD246-PL-01-R
☞ 1xG9 28W
H min: 225, H max: 1385,
W: 140, L: 65 mm



▲
MOD246-PL-01-GN
☞ 1xG9 28W
H min: 225, H max: 1385,
W: 140, L: 65 mm



▲
MOD246-PL-01-AM
☞ 1xG9 28W
H min: 225, H max: 1385,
W: 140, L: 65 mm



▲
MOD246-PL-01-TR
☞ 1xG9 28W
H min: 225, H max: 1385,
W: 140, L: 65 mm



▲
MOD246-PL-01-BL
☞ 1xG9 28W
H min: 225, H max: 1385,
W: 140, L: 65 mm



MOD267-PL-01-PN/RG/YW/BL

☞ 1xE14 40W

H min: 320, H max: 1330, D: 120 mm,

□ d=120

BALL

en Metal frame and metal socket of various colours. Lampshade in the form of white matt glass globe. **de** Metallrahmen und Lampenfassung in verschiedenen Farben. Lampenschirm in Form einer weißen Kugel aus Mattglas. Verwendung von kerzenförmigen Leuchtmitteln wird empfohlen. **fr** Armature et boîtier en métal de différentes couleurs. Abat-jour en forme de globe en verre blanc dépoli. **it** Struttura in metallo e portalampada disponibile in vari colori. Diffusore in vetro bianco opaco. **es** Estructura y portalámparas de metal de varios colores. Pantalla en forma de esfera de *cristal color blanco mate. **pl** Metalowe obramowanie i metalowe gniazdo w różnych kolorach. Klosz w postaci białego, matowego, szklanego globusiu. **ru** Каркас и патрон из металла разных цветов. Плафон в виде шара из белого матового стекла. Использование ламп в форме свечи.



● Yellow / YW

● Pink / PN

● Blue / BL

● Pink Gold/ RG



▲
MOD199-PL-03-W/G
☞ 1xE27 60W
H min: 260, H max: 1460,
D: 150 mm,
▢ d1=70 / d2=120 / h=200

LOUVRE

en Multi-faceted metal diffuser. Adjustable height. **de** Facettenreicher Diffusor aus Metall. Höhenverstellbar.
fr Diffuseur métallique multi-faces, hauteur ajustable. **it** Diffusore in metallo sfaccettato. Altezza regolabile.
es Difusor de metal facetado Altura ajustable. **pl** Wielopłaszczyznowy dyfuzor metalowy. Regulowana wysokość. **ru** Многогранный металлический плафон. Регулируемая длина.



○ White / W

● Gold / G



▲
P359-PL-01-W
 ☞ 1xE27 60W
 H min: 220, H max: 1400,
 D: 220 mm,
 □ d1=95 / d2=220 / h=137



▲
P359-PL-220-C
 ☞ 1xE27 60W
 H min: 220, H max: 1400,
 D: 220 mm,
 □ d1=95 / d2=220 / h=137



▲
P359-PL-350-C
 ☞ 1xE27 60W
 H min: 290, H max: 1470,
 D: 360 mm,
 □ d1=23 / d2=350 / h=170

▲
P359-PL-140-C/W
 ☞ 1xE27 60W
 H min: 240, H max: 1420,
 D: 140 mm,
 □ d1=60 / d2=140 / h=165

BICONES

en Metal ceiling cup and diffuser with decorative wooden element. **de** Deckenbaldachin aus Metall und Diffusor mit dekorativem Element aus Holz. **fr** Coupelle en métal, diffuseur avec éléments en bois décoratifs. **it** Calotta da soffitto e diffusore in metallo con elemento decorativo in legno. **es** Florón y difusor de metal con elemento decorativo de madera. **pl** Metalowa puszka sufitowa i dyfuzor z dekoracyjnym elementem drewnianym. **ru** Арматура и потолочная чаша из металла. Плафон украшен декоративным элементом из дерева.



○ White / W

● Black / B

● Grey / GR



P019-PL-01-W
1xE27 60W
H min: 320, H max: 1010,
D: 190 mm,
□ d1=105 / d2=190 / h=190

CUP

en Matte white metal diffuser with wooden decorative element. Adjustable height. **de** Mattweißer Diffusor aus Metall mit dekorativem Element aus Holz. Höhenverstellbar. **fr** Diffuseur métal blanc mat avec éléments décoratifs en bois, hauteur ajustable. **it** Diffusore in metallo bianco opaco con elemento decorativo in legno. Altezza regolabile. **es** Difusor de metal blanco mate con elemento decorativo de madera. Altura ajustable. **pl** Matowo-biały dyfuzor metalowy z drewnianym elementem dekoracyjnym. Regulowana wysokość. **ru** Плафон сделан из белого матового металла. Декоративный элемент из дерева в основании. Регулируемая длина.



 Black and White / BW



P535PL-01GR/PN/B/W
 1xE27 60W
 H min: 515, H max: 2012,
 D: 350 mm,
 □ d=350 / h=280



P534PL-01PN/B/GR/W
 1xE27 60W
 H min: 400, H max: 1897,
 D: 250 mm,
 □ d=250 / h=205

BELLEVUE

en Metal powder-coated diffusers, enameled white inside. Available in 4 colours and 2 different sizes. **de** Pulverbeschichtete Diffusoren aus Metall, innen weiß lackiert. Erhältlich in 4 Farben und 2 verschiedenen Größen. **tr** Diffuseur avec revêtement en poudre de métal. **it** Diffusori in metallo verniciato a polvere, con interno smaltato bianco. Disponibile in 4 colori e in 2 misure diverse. **es** Difusores metalizados, esmaltados en blanco por dentro. Disponible en 4 colores y 2 tamaños diferentes. **pl** Dyfuzory metalowe malowane proszkowo, wewnątrz emaliowane na biało. Dostępne w 4 kolorach i 2 różnych rozmiarach. **ru** Плафоны выполнены из металла и окрашены порошковым способом. Внутренняя часть плафонов выполнена из эмали белого цвета. Модель представлена в 4-х цветах и 2-х размерах.



○ White / W

● Black / B

● Grey / GR

● Pink / PN



◀ P111-PL-225-G

⦿ 1xE14 40W

H min: 260, H max: 1455,

D: 255 mm,

□ d=225 / h=125

KENDAL

en Bi-colour metal diffuser. Adjustable height. **de** Metalldiffusor aus zwei Farben. Höhenverstellbar.

fr Diffuseur métallique bi-color, hauteur ajustable. **it** Diffusore in metallo bicolore. Altezza

regolabile. **es** Difusor bicolor de metal. Altura ajustable. **pl** Dyfuzor metalowy dwukolorowy.

Regulowana wysokość. **ru** Плафон из металла 2-х цветов. Регулируемая длина подвеса.



● Chrome / CH



◀
T162-01-B
 1x E27 60W
 H min: 260, H max: 1450,
 D: 170 mm,
 □ d=170 / h=185



◀
T162-00-B
 1x E27 60W
 H min: 350, H max: 1540,
 D: 155 mm,
 □ d1=20 / d2=155 / h=175

DANAS

en Metal frame, smoked glass diffuser. **de** Metallrahmen, Diffusor aus Rauchglas.

fr Support en métal, diffuseur en verre fumé. **it** Struttura in metallo, diffusore in vetro

fumé. **es** Estructura metálica, difusor de cristal ahumado. **pl** Metalowe obramowanie,

dyfuzor z opalanego szkła. **ru** Арматура из металла. Плафон из стекла дымчатого цвета.



● Black / B



◀
T314-00-B
 1x E27 60W
 H min: 310, H max: 1500,
 D: 175 mm,
 □ d1=51 / d2=175 / h=250



◀
T314-01-B
 1x E27 60W
 H min: 320, H max: 1550,
 D: 210 mm,
 □ d1=60 / d2=160 / h=262



◀
T314-11-B
 1x E27 60W
 H min: 275, H max: 1510,
 D: 250 mm,
 □ d1=60 / d2=175 / h=215

BERGEN

en Metal frame, smoked glass diffuser with drop effect. **de** Metallrahmen, Diffusor

aus Rauchglas mit Tropfen-Effekt. **fr** Armature en métal, diffuseur verre fumé avec

effet gouttelettes. **it** Struttura in metallo, diffusore in vetro fumé con effetto goccia.

es Estructura metálica, difusor de cristal ahumado con efecto gota. **pl** Metalowe

obramowanie, dyfuzor z efektem kropli. **ru** Арматура из металла. Плафон из матового

стекла с эффектом «мокрых капель».



● Black / B



◀ P019-PL-01-N

☉ 1xE27 60W

H min: 380, H max: 1534,

D: 280 mm,

▢ d1=12 / d2=280 / h=265

◀ P018-PL-01-N

☉ 1xE27 60W

H min: 400, H max: 1554,

D: 220 mm,

▢ d1=42 / d2=220 / h=285

MORENO

en Metal frame, textured glass diffuser. **de** Metallrahmen, Diffusor aus Strukturglas.

fr Armature métallique, diffuseur en verre texturé. **it** Struttura in metallo, diffusore in vetro

testurizzato. **es** Estructura metálica, difusor de cristal texturizado. **pl** Metalowe obramowanie,

dyfuzor szklany teksturowany. **ru** Арматура из металла. Плафоны из фактурного стекла.



● Chrome / CH



▲
P017PL-01BS/B/W
 1xGU10 50W
 H min: 272, H max: 1372,
 D: 250 mm,
 □ d1=55 / d2=250 / h=110



▲
P016PL-01B/BS/W
 1xGU10 50W
 H min: 297, H max: 1397,
 D: 200 mm,
 □ d1=55 / d2=200 / h=135



▲
P015PL-01BS/W/B
 1xGU10 50W
 H min: 305, H max: 1405,
 D: 150 mm,
 □ d1=55 / d2=150 / h=145

OLA

en Metal cup, glass diffuser available in 3 finishes: frosted, amber, smoked. Decorative wooden element. Adjustable height.

de Deckenbaldachin aus Metall, Diffusor aus Glas in 3 Ausführungen erhältlich: mattiert, bersteinfarbig, geräuchert. Dekoratives

Element aus Holz. Höhenverstellbar. **fr** Coupelle en métal, diffuseur en verre disponible en 3 finitions: dépoli, ambre, fumé.

Élément en bois décoratif. Hauteur réglable. **it** Calotta in metallo, diffusore in vetro disponibile in 3 finiture: acidato, ambrato,

fumé. Elemento decorativo in legno. Altezza regolabile. **es** Florón metálico, difusor de vidrio disponible en 3 acabados: esmerilado,

ámbar, ahumado. Elemento decorativo de madera. Altura ajustable. **pl** Metalowa puszcza sufitowa, szklany dyfuzor dostępny w 3

wykończeniach: matowy, bursztynowy, opalany. Dekoracyjny element drewniany. Regulowana wysokość. **ru** Потолочная чаша

из металла. Плафон выполнен из стекла и представлен в 3-х цветах: матовом, янтарном и дымчатом.



○ White Matt / W ● Black Matt / B ● Brass / BS



▲
T163PL-01C
 ⚡ 1xE27 40W
 H min: 410, H max: 1500,
 D: 300 mm,
 □ d1=90 / d2=300 / h=217



▲
T163-11-C
 ⚡ 1xE27 40W
 H min: 310, H max: 1500,
 D: 200 mm,
 □ d=200 / h=145



▲
T163-11-R
 ⚡ 1xE27 40W
 H min: 310, H max: 1500,
 D: 200 mm,
 □ d=200 / h=145



▲
T163PL-01R
 ⚡ 1xE27 40W
 H min: 410, H max: 1500,
 D: 300 mm,
 □ d1=90 / d2=300 / h=217



▲
T163PL-01W
 ⚡ 1xE27 40W
 H min: 410, H max: 1500,
 D: 300 mm,
 □ d1=90 / d2=300 / h=217

▲
T163-11-W
 ⚡ 1xE27 40W
 H min: 310, H max: 1500,
 D: 200 mm,
 □ d=200 / h=145



▲
T163-01-W
 ⚡ 1xE27 40W
 H: 270, W: 200, L: 250 mm,
 □ d=200 / h=145



▲
T163-01-C
 ⚡ 1xE27 40W
 H: 270, W: 200, L: 250 mm,
 □ d=200 / h=145

IRVING

en Glass diffuser with brass central metal frame. Adjustable height. **de** Diffusor aus Glas mit zentralem Metallrahmen aus Messing. Höhenverstellbar. **fr** Diffuseur en verre avec support en métal. Hauteur réglable. **it** Diffusore in vetro con struttura metallica centrale in ottone. Altezza regolabile. **es** Difusor de vidrio con Estructura central de de latón. Altura ajustable. **pl** Szklany dyfuzor z mosiężnym, metalowym obramowaniem centralnym. Regulowana wysokość. **ru** Плафон из стекла с металлическим элементом цвета латуни. Регулируемая высота.



● Black / B



▲
T163-01-R
 ⚡ 1xE27 40W
 H: 270, W: 200, L: 250 mm,
 □ d=200 / h=145



◀
 MOD470-TL-01-W/B
 ⚡ 1xE14 40W
 H: 485, D: 240 mm,
 □ d=240 / h=225,
 Class 2

NASHORN

en Metal frame, polyresin decorative base. PVC shade covered in fabric. **de** Metallrahmen, dekorativer Sockel aus Polyresin. Lampenschirm aus PVC mit Stoffbezug. **fr** Support en métal, base décorative en polyrésine. Abat-jour en PVC recouvert de tissu. **it** Struttura in metallo, base decorativa in poliresina. Paralume in PVC rivestito in tessuto. **es** Estructura metálica, base decorativa de poliresina. Pantalla de PVC recubierta de tela. **pl** Metalowe obramowanie, baza dekoracyjna z żywicy poliestrowej. Klosz PCV pokryty tkaniną. **ru** Арматура из металла, основание из полирезина. Абажур из ПВХ покрыт тканью.



○ White / W

● Black / B



◀
Z148-TL-01-E
 ⚡ 1xE27 40W
 H: 505, W: 180, L: 245 mm,
 □ h=190

PIXAR

en Table lamp of metal. Adjustable lampshade. **de** Metallene Tischleuchte in den Farben Grün, Blau und Weiß. Frei justierbarer Lampenkopf. **fr** Lampe de table en métal. Abat-jour réglable. **it** Lampada da tavolo in metallo. Diffusore orientabile. **es** Estructura de metal. Difusor ajustable. **pl** Lampa stołowa z metalu. Regulowany klosz lampy. **ru** Настольная лампа из металла. Плафон регулируемый.



 Green / E



Z137-TL-01-GR/W
 1xE27 40W
 H min: 370, H max: 790,
 W: 170, L: 400 mm,
 Δ d=145 / h=85,
 Class 2

ZEPPPO 137

en Metal frame in two colours. Swivel bracket with metal links of bronze colour. **de** Designer-Tischleuchte. Schwenkbügel mit Metallgliedern in Bronze. **fr** Armature métallique. Support pivotant avec liaisons métalliques de couleur bronze. **it** Struttura in metallo. Orientabile con elementi metallici bronzo. **es** Estructura de metal. Soporte giratorio con uniones de metal color bronce. **pl** Metalowe obramowanie w dwóch kolorach. Uchwyt obrotowy z metalowymi ogniwami w kolorze brąz. **ru** Каркас из металла. Вращающийся кронштейн.



○ White / W

● Grey / GR



▲
Z147-TL-01-B
 ⚡ 1xE14 40W
 H: 500, W: 200, L: 350 mm,
 □ d1=60 / d2=160 / h=115



◀
Z147-TL-01-W
 ⚡ 1xE14 40W
 H: 500, W: 200, L: 350 mm,
 □ d1=60 / d2=160 / h=115



◀
Z147-TL-01-YE
 ⚡ 1xE14 40W
 H: 500, W: 200, L: 350 mm,
 □ d1=60 / d2=160 / h=115

APEX

en Metal frame. Flexible wooden stem, adjustable diffuser. **de** Metallrahmen erhältlich. Flexibles Holzgestell, verstellbarer Leuchtenkopf. **fr** Lampe de table. Tige en bois flexible, diffuseur orientable. **it** Lampada da tavolo in metallo con braccio flessibile in legno. Diffusore regolabile. **es** Base y difusor metálico. Brazo flexible de madera. **pl** Metalowe obramowanie. Elastyczny drewniany wspornik, regulowany dyfuzor. **ru** Каркас из металла. Гибкий деревянный кронштейн, регулируемый рассеиватель.



○ White / W

● Black / B

● Yellow / YW



CALVIN

en Natural wood tripod. Shade covered with fabric, chrome metal support. **de** Stativ aus Naturholz. Lampenschirm mit Stoffbezug, verchromter Träger aus Metall. **fr** Trépied en bois naturel. Abat-jour recouvert de tissu, support en métal chromé. **it** Treppiede in legno naturale. Paralume rivestito in tessuto, supporto in metallo cromato. **es** Trípode de madera natural. Pantalla cubierta con tela, soporte de metal cromado. **pl** Trójnożna podstawa z naturalnego drewna. Abażur pokryty tkaniną, wspornik chromowany metalowy. **ru** Штатив (тренога) из дерева. Абажур из ПВХ покрыт хлопком.



 Brown / BR



▲
Z177-FL-01-BR
 1xE27 60W
 H: 1615, D: 510 mm,
 □ d1=400 / d2=440 / h=300,
 Class 2



◀
Z001FL-L3W-1W
 1x E27 60W
 H: 1629, W: 370, L: 370 mm,
 Class 2



FAREL

en Metal frame, fabric covered shade. Adjustable spot. 3 lighting modes. **de** Metallrahmen, Lampenschirm mit Stoffbezug. Einstellbarer Spot. 3 Beleuchtungsarten. **fr** Support en métal, abat-jour en tissu. Spot réglable. 3 modes d'éclairage. **it** Struttura in metallo, paralume rivestito in tessuto. Spot regolabile. 3 intensità diverse di illuminazione. **es** Estructura de metal, pantalla cubierta de tela. Punto ajustable. 3 modos de iluminación. **pl** Metalowe obramowanie, abażur pokryty tkaniną. Regulowany spot. 3 tryby oświetlenia. **ru** Арматура из металла. Абажур из ткани. Регулировка направления спота. Работает в 3-х режимах освещения.



○ White / W

● Black / B



▲
Z001FL-L3W-1B
 1x E27 60W
 H: 1629, W: 370, L: 370 mm,
 □ h=290,
 Class 2



NEVADA

en Metal frame, fabric covered shade. Adjustable bracket. **de** Metallrahmen, Lampenschirm mit Stoffbezug. Verstellbare Halterung. **fr** Support en métal, abat-jour en tissu. Support réglable. **it** Struttura in metallo, paralume rivestito in tessuto. Staffa regolabile. **es** Estructura de metal, pantalla cubierta de tela. Soporte ajustable. **pl** Metalowe obramowanie, abażur pokryty tkaniną. Regulowany wspornik. **ru** Арматура из металла. Регулируемый кронштейн. Абажур из ПВХ покрыт тканью.



● Chrome / CH

▲
Z329-FL-01-CH
⊕ 1xE27 40W
H: 2100, W: 400, L: 1400 mm,
□ d=400 / h=260



◀
Z010FL-L8B3K
 LED 8W
 H: 1387, W: 240, L: 305 mm,
 Class 2, 700 Lumen



◀
Z010TL-L8B3K
 LED 8W
 H: 455, W: 150, L: 150 mm,
 Class 2, 550 Lumen



◀
Z010TL-L8W3K
 LED 8W
 H: 455, W: 150, L: 150 mm,
 Class 2, 550 Lumen

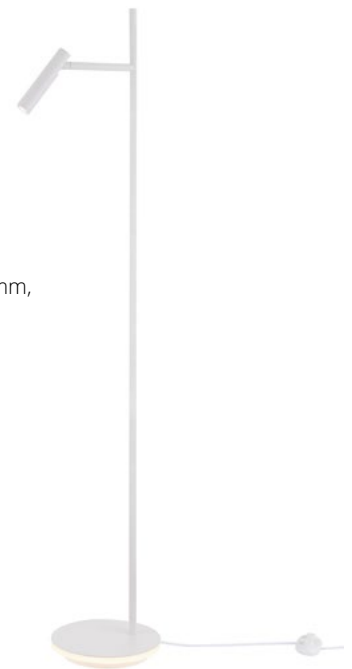

▲
Z010FL-L8W3K
 LED 8W
 H: 1387, W: 240, L: 305 mm,
 Class 2, 700 Lumen

ESTUDO

en Metal frame. Decorative backlighting. Adjustable. **de** Metallrahmen. Dekorative Hintergrundbeleuchtung. Ein drehbarer Lampenschirm passt die Richtung des Lichtstroms an. **fr** Armature en métal. Rétro-éclairage décoratif. Un abat-jour rotatif ajuste la direction du flux lumineux. **it** Struttura in metallo, spot orientabile. Base illuminata. **es** Estructura de metal. Luz decorativa de la Iluminación. Gracias a la tulipa giratoria, la dirección del flujo de luz es ajustable. **pl** Metalowe obramowanie. Dekoracyjne podświetlenie. Regulowana wysokość. **ru** Арматура из металла. Декоративная подсветка освещения. Благодаря вращающемуся плафону регулируется направление светового потока.



○ White / W ● Black / B



▲
MIR003WL-L7CH
 LED 7W
 H: 48, W: 420, L: 200 mm,
 550 Lumen



▲
MIR003WL-L16CH
 LED 16W
 H: 48, W: 720, L: 200 mm,
 1200 Lumen



▲
MIR003WL-L12CH
 LED 12W
 H: 48, W: 520, L: 220 mm,
 860 Lumen

FINO

en Metal frame, LED module. Polycarbonate diffuser. **de** Metallrahmen, LED Modul. Diffusor aus Polycarbonat. **fr** Support en métal, module LED. Diffuseur en polycarbonate. **it** Struttura in metallo, modulo LED. Diffusore in polycarbonato. **es** Estructura metálica, módulo LED. Difusor de polycarbonato. **pl** Metalowe obramowanie, moduł LED, dyfuzor poliwęglanowy. **ru** Арматура из металла. Рассеиватель из PC-пластика. LED-модуль.



● Chrome / CH



▲
MIR002WL-L12CH
💡 LED 12W
H: 45, W: 560, L: 70 mm,
1000 Lumen



▲
MIR002WL-L14CH
💡 LED 14W
H: 45, W: 660, L: 70 mm,
1200 Lumen

LAO

en Metal frame, acrylic diffuser. LED module. Chrome finish. **de** Metallrahmen, Diffusor aus Acryl. LED Modul. Verchromte Ausführung. **fr** Support en métal, diffuseur en acrylique. Module LED. Finition chrome. **it** Struttura in metallo, diffusore in acrilico. Modulo LED. Finitura cromata. **es** Estructura metálica, difusor acrílico. Módulo LED. Acabado cromado. **pl** Metalowe obramowanie, dyfuzor akrylowy. Moduł LED. Wykończenie chromowane. **ru** Арматура из металла, цвет - хром. Плафон из акрила. LED-модуль.



● Chrome / CH



▲
MIR004WL-L12B
 LED 12W
 H: 115, W: 550, L: 225 mm,
 800 Lumen



▲
MIR004WL-L12BZ
 LED 12W
 H: 115, W: 550, L: 225 mm,
 800 Lumen

FINELLI

en Metal frame, LED module. Polycarbonate diffuser. Polished black or brass finish. **de** Metallrahmen, LED Modul. Diffusor aus Polycarbonat. Polierte schwarze oder messingfarbene Ausführung. **fr** Support en métal, module LED. Diffuseur en polycarbonate. Finition noire ou en laiton poli. **it** Struttura in metallo, modulo LED. Diffusore in polycarbonato. Finitura lucida nera o ottone. **es** Estructura metálica, módulo LED. Difusor de polycarbonato. Acabado negro o latón pulido. **pl** Metalowe obramowanie, moduł LED, dyfuzor poliwęglanowy. Wykończenie polerowane na czarno lub miedziane. **ru** Арматура из металла. Рассеиватель из PC-пластика. LED-модуль. Модель представлена в 2х цветах: черный и бронза.



● Black / B

● Bronze / BZ



▲
MIR005WL-L16W
LED 16W
H: 50, W: 410, L: 85 mm,
1200 Lumen



▲
MIR005WL-L16B
LED 16W
H: 50, W: 410, L: 85 mm,
1200 Lumen

GLEAM

en Metal frame,integrated LED module. **de** Metallrahmen, integriertes LED Modul. **fr** Support en métal, module LED intégré. **it** Struttura in metallo, modulo LED integrato. **es** Estructura metálica, módulo LED integrado. **pl** Metalowe obramowanie, zintegrowany moduł LED. **ru** Арматура из металла. Встроенный LED-модуль.



○ White / W

● Black / B



▲
 MOD362-CL-01-60W-W
 LED 60W
 H: 131, D: 495 mm,
 h=131,
 Dimmable, 3000 Lumen

MUSIC 60

en Lamp frame of metal. Plastic lampshade. Modern dual-band speaker with total power of 6W. Lamp is controlled with remote control via Bluetooth (InLux applications on iOS or Android). LED module. **de** Moderne Deckenleuchte mit zwei eingebauten Dual-Band-Lautsprechern (6W). Steuerung über Bluetooth (InLux Apps auf iOS oder Android). Leuchte mit Metallrahmen, Plastischirm und LED-Modul. **fr** Plafonnier en métal. Abat-jour en plastique. Haut-parleur moderne à double bande avec une puissance totale de 6 W. Mise en marche à l'aide d'une télécommande via Bluetooth (applications InLux sur iOS et Android). Module LED. **it** Struttura in metallo. Diffusore in plastica. Moderno altoparlante dual-band con potenza totale di 6W. La lampada è controllata con telecomando via Bluetooth (applicazioni InLux su iOS o Android). Modulo LED. **es** Estructura de metal. Pantalla de plástico. Altavoz de doble banda con una potencia total de 6 W. La lámpara se controla de forma remota a través de Bluetooth (aplicaciones InLux en iOS o Android). Módulo LED integrado. **pl** Obrotowanie metalowe. Klosz plastikowy. Nowoczesny głośnik dwuzakresowy o łącznej mocy 6W. Lampa jest sterowana za pomocą pilota zdalnego sterowania przez Bluetooth (aplikacje InLux na iOS lub Android). Moduł LED. **ru** Каркас светильника из металла. Плафон из пластика. Современная 2-х полосная колонка общей мощностью 6W. Управление светильником с помощью пульта через Bluetooth (приложения InLux на IOS или Android). LED модуль.



○ White / W



▲
C6998-CL-45-W
LED 45W
H: 104, D: 548 mm,
h=64,
Dimmable, Class 2,
3600 Lumen

HALO

en Acrylic lamp with a flicker effect. LED module. Changeable colour temperature and brightness. Remote control and switch. **de** Acryl-Lampe mit Flimmer-Effekt. LED-Modul mit regulierbarer Helligkeit und Farbtemperatur über Fernbedienung und Schalter. **fr** Lampe acrylique avec un effet de scintillement, module LED intégré. Température de couleur et luminosité changeantes. Télécommande et interrupteur. **it** Lampada in acrilico con effetto flicker. Modulo LED. Temperatura di colore e luminosità variabili. Telecomando e interruttore. **es** Lámpara acrílica con efecto brillo. Color de la luz y luminosidad regulables. Mando a distancia. **pl** Lampa akrylowa z efektem migotania. Moduł LED. Możliwość zmiany temperatury światła i jasności. Zdalne sterowanie i przełącznik. **ru** Светильник из акрила с эффектом мерцания. LED модуль. Изменение цветовой температуры и яркости. Управление с пульта и выключателя.



○ White / W



▲
C6999-CL-75-W
 LED 75W
 H: 120, D: 770 mm,
 Dimmable, 4700 Lumen



◀
C6999-CL-45-W
 LED 45W
 H: 105, D: 495 mm,
 Dimmable, 3100 Lumen

GLORIA

en Acrylic diffuser, LED module, RGB and dimmable. Remote control included. **de** Diffusor aus Acryl, LED Modul, RGB und dimmbar. Fernbedienung im Lieferumfang enthalten. **fr** Diffuseur acrylique, module LED RGB, température et luminosité réglable par télécommande incluse. **it** Diffusore in acrilico, modulo LED, RGB e dimmerabile. Telecomando incluso. **es** Difusor acrílico, módulo LED, RGB y regulable. Mando a distancia incluido. **pl** Dyfuzor akrylowy, moduł LED, RGB i możliwość przyciemniania. W zestawie pilot zdalnego sterowania. **ru** Плафон выполнен из акрила. LED-модуль. Изменение цветовой температуры и яркости. Пульт дистанционного управления в комплекте.



○ White / W



▲
C615CL-L60CH
 LED 60W
 H: 87, D: 520 mm,
 □ d1=520 / d2=450 / h=80,
 Dimmable, Class 2,
 5111 Lumen



▼
C615CL-L40CH
 LED 40W
 H: 85, D: 450 mm,
 □ d1=450 / d2=380 / h=80,
 Dimmable, Class 2,
 2832 Lumen

LULEA

en Acrylic lamp with a flicker effect. LED module. Color temperature and brightness can be changed with remote control.
de Leuchte aus Acryl mit Flimmer-Effekt. LED-Modul mit regulierbarer Farbtemperatur und Helligkeit. Fernbedienung und Schalter anbei.
fr Luminaire en acrylique avec effet de scintillement. Module LED. Modification de la température de couleur et de la luminosité. Réglage par télécommande.
it Lampada in acrilico con effetto flicker. Modulo LED. Temperatura di colore e luminosità regolabili tramite telecomando.
es Lámpara de acrílico con efecto metálico. Módulo LED integrado. Brillo y temperatura del color regulables. Control remoto e interruptor.
pl Lampa akrylowa z efektem migotania. Moduł LED. Temperatura koloru i jasność mogą być zmieniane za pomocą pilota zdalnego sterowania.
ru Светильник из акрила с эффектом мерцания. LED-модуль. Изменение цветовой температуры и яркости. Управление с пульта и выключателя.



● Chrome / CH



Neoclassic
Elegant
House
Royal Classic
Ceiling & Wall
Table & Floor
Picture
Diamant Crystal
Downlight

MAYTONI CLASSIC



MOD014CL-06N

6x E14 40W

H min: 545, H max: 1460,

D: 700 mm,

□ d=170 / h=125



MOD014WL-01N

1x E14 40W

H: 260, W: 170, L: 260 mm,

□ d=170 / h=125



MOD014TL-01N

1x E14 40W

H: 460, D: 265 mm,

□ d=265 / h=170,

Class 2



MOD014FL-01N

1x E27 40W

H: 1580, D: 400 mm,

□ d=140 / h=255

Class 2

ALICANTE

en Metal frame, decorative glass elements. Fabric covered shades. **de** Metallrahmen, dekorative Elemente aus Glas. Stoffbezogene Lampenschirme. **fr** Support en métal, éléments décoratifs en verre. Abat-jours couverts de tissu. **it** Struttura in metallo, elementi decorativi in vetro. Paralumi rivestiti in tessuto. **es** Estructura metálica, elementos decorativos de vidrio. Tonos cubiertos de tela. **pl** Metalowe obramowanie, dekoracyjne elementy szklane. Klosze pokryte tkaniną. **ru** Арматура из металла. Декоративные элементы из стекла. Абажуры из ПВХ покрыты тканью.



● Nickel / N

◀
MOD014CL-08N
⊕ 8xE14 40W
H min: 545, H max: 1460,
D: 820 mm,
□ d=170 / h=125





MOD603-06-N
 ⚡ 6xE14 40W
 H max: 730, Hmix: 1182,
 D: 710 mm,
 □ d=160 / h=115,
 2 in 1



MOD603-01-N
 ⚡ 1xE14 40W
 H: 375, W: 160, L: 264 mm,
 □ d=160 / h=115

BUBBLE DREAMS

en Metal frame, glass body and arms. Translucent fabric shades. **de** Metallrahmen, Korpus und Arme aus Glas. Transparente Stoffschirme. **fr** Support en métal, corps et bras en verre. Abat-jours en tissu transparent. **it** Struttura in metallo, corpo e bracci in vetro. Paralumi in tessuto traslucido. **es** Estructura de metal, cuerpo y brazos de vidrio. Tonos de tela translúcidos. **pl** Metalowe obramowanie, szklana obudowa i ramiona. Klosze z przezroczystej tkaniny. **ru** Арматура из металла. Корпус и рожки из стекла. Абажуры из полупрозрачной белой ткани.



● Chrome / CH



MOD603-08-N
☉ 8xE14 40W
H max: 730, Hmix: 1182,
D: 840 mm,
□ d=160 / h=115,
2 in 1

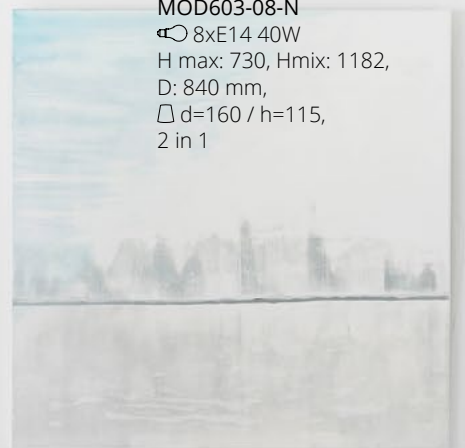

MOD603-11-N
☉ 1xE14 40W
H: 500, D: 270 mm,
□ d=270 / h=150,
Class 2





MOD334-PL-05-N

5xE14 40W

H min: 700, H max: 1000,

D: 620 mm,

□ d1=90 / d2=160 / h=120



MOD334-WL-01-N

1xE14 40W

H: 250, W: 150, L: 250 mm,

□ d1=90 / d2=160 / h=120

TALIA

en Metal frame. Lampshades of white corrugated material. Decorative pendants. **de** Metallrahmen. Weiße gefaltete Stoffschirme. Dekorative angehängte Elemente. **fr** Armature en métal. Abat-jours en tissu ondulé blanc. **it** Struttura in metallo. Diffusori di tessuto bianco plissettato. Pendenti di cristallo. **es** Estructura de metal. Pantallas de material corrugado blanco. Colgantes decorativos. **pl** Metalowe obramowanie. Lamy z białego materiału falistego. Ozdobne wisiorki. **ru** Арматура из металла. Абажуры из гофрированного белого материала. Декоративные подвески.



● Nickel / N



▲
MOD334-PL-08-N
⦿ 8xE14 40W
H min: 710, H max: 1010,
D: 770 mm,
□ d1=90 / d2=160 / h=120



MOD206-01-N
 ⚡ 1xE14 40W
 H min: 450, H max: 1750,
 D: 180 mm,
 □ d1=90 / d2=180 / h=170



MOD206-02-N
 ⚡ 2xE14 40W
 H: 480, W: 370, L: 220 mm,
 □ d1=75 / d2=160 / h=145

BOSCAGE

en Metal frame, polished chrome finish. Black fabric shades **de** Metallrahmen, poliert chrom.
 Lampenschirme mit schwarzem Stoff bezogen. **fr** Support en métal, fini chromé poli. Abat-jours en tissu noir. **it** Struttura in metallo, finitura in cromo lucido. Paralumi in tessuto nero. **es** Estructura metálica, acabado en cromo pulido. Tonos de tela negra. **pl** Metalowe obramowanie, wykończenie z polerowanego chromu. Klosze z czarnej tkaniny. **ru** Арматура из металла, цвет - хром. Абажуры из черной ткани.



● Nickel / N



▲
MOD206-08-N
⚡ 8xE14 40W
H min: 500, H max: 900,
D: 760 mm,
□ d1=75 / d2=160 / h=145,
2 in 1



▲
 MOD602-06-N
 ⌀ 6x E14 40W
 H min: 670, H max: 900,
 D: 600 mm,
 □ d=600 / h=163,
 2 in 1

MIRAGGIO

en Metal frame, chrome finish. Decorative crystal pendants. White-coloured threads shade. **de** Metallrahmen, verchromt. Dekorative Anhänger aus Kristall. Weißer Fadenschirm. **fr** Support en métal, finition chromée. Pendentifs en cristal décoratifs. Fil de couleur blanche. **it** Struttura in metallo, finitura cromata. Pendenti decorativi in cristallo. Paralume fili bianco. **es** Estructura metálica, acabado cromado. Colgantes decorativos de cristal. Pantallas de hilos de color blanco. **pl** Metalowe obramowanie, chromowane. Dekoracyjne kryształowe wisioriki. Klosz z nici w kolorze białym. **ru** Арматура из металла, цвет - хром. Декоративные подвески из хрусталя. Абажур покрыт нитями белого цвета.



● Chrome / CH



◀
MOD602-04-N
 ⚡ 4xE14 40W
 H min: 670, H max: 900,
 D: 555 mm,
 □ d=556 / h=163,
 2 in 1



▶
MOD602-FL-01-N
 ⚡ 1xE27 40W
 H: 1660, D: 420 mm,
 □ d=420 / h=260
 Class 2



▶
MOD602-00-N
 ⚡ 1xE14 40W
 H min: 630, H max: 900,
 D: 140 mm,
 □ d=145 / h=160



▶
MOD602-TL-01-N
 ⚡ 1xE14 40W
 H: 520, D: 280 mm,
 □ d=280 / h=180
 Class 2



▶
MOD602-01-N
 ⚡ 1xE14 40W
 H: 305, W: 170, L: 242 mm,
 □ d=170 / h=120



ARM526TL-01GR
 1xE27 40W
 H: 450, D: 250 mm,
 □ d=250 / h=170,
 Class 2



ARM526WL-01GR
 1xE14 40W
 H: 300, W: 180, L: 195 mm,
 □ d=180 / h=170

MARYLAND

en Metal frame. Combined body made of polyresin and transparent glass. PVC lampshade covered in cloth. **de** Leuchte mit besonderer Materialwahl: der Körper aus Polyresin und transparentem Glas, Rahmen aus Metall. PVC-Lampenschirm mit Stoffbezug. **fr** Armature métallique. Structure en polyrésine et verre transparent. Abat-jour en PVC couvert de tissus. **it** Struttura in metallo. Corpo in poliresina e vetro trasparente. Diffusore in PVC rivestito in tessuto. **es** Estructura de metal. Cuerpo realizado en una combinación de polirresina y vidrio transparente. Pantalla de PVC revestida de tela. **pl** Metalowe obramowanie. Kombinowany korpus z żywicy poliestrowej i przezroczystego szkła. Klosz z PCV pokryty tkaniną. **ru** Арматура из металла. Комбинированный каркас из полирезина и прозрачного стекла. Абажур из ПВХ покрыт тканью.



● Grey / GR



▲
ARM010-08-W
⊕ 8xE14 40W
H min: 870, H max: 1070,
D: 1000 mm,
□ d1=110 / d2=260 / h=170

INTRECCIO

en Metal frame, fabric lampshades. Golden decorative ribbons. **de** Metallrahmen, Lampenschirme aus Stoff. Goldene Dekorationsbänder. **fr** Support en métal, abat-jours en tissu. **it** Struttura in metallo, paralumi in tessuto. Nastri decorativi dorati. **es** Estructura metálica, pantallas de tela. Cintas decorativas doradas. **pl** Metalowe obramowanie, klosze z tkaniny. Złote taśmy ozdobne. **ru** Арматура из металла, абажуры из ПВХ покрыты тканью. Декоративные элементы золотого цвета в виде лент.



White with Gold / WG



▲
ARM010-06-W
 ⚡ 6xE14 40W
 H min: 880, H max: 1080,
 D: 870 mm,
 □ d1=190 / d2=340 / h=250



▲
ARM010-01-W
 ⚡ 1xE27 40W
 H: 1650, D: 340 mm,
 □ d1=190 / d2=340 / h=250,
 Class 2



▲
ARM010-02-W
 ⚡ 2xE14 40W
 H: 410, W: 410, L: 230 mm,
 □ d1=80 / d2=140 / h=155



▲
ARM010-11-W
 ⚡ 1xE14 40W
 H: 450, W: 260, L: 110 mm,
 Class 2





ARM154-06-S

⊙ 6xE14 40W

H min: 530, H max: 1030,

D: 740 mm,

□ d1=90 / d2=150 / h=130,

2 in 1



ARM154-01-S

⊙ 1xE14 40W

H: 330, W: 150, L: 240 mm,

□ d1=90 / d2=150 / h=130

MONSOON

en Metal frame with decorative elements. Antique grey finish. Shades covered in organza. **de** Metallrahmen mit dekorativen Elementen. Antike graue Ausführung. Lampenschirme mit Organza bedeckt. **fr** Support en métal avec éléments décoratifs. Finition gris antique. Abat-jours en organza. **it** Struttura in metallo con elementi decorativi. Finitura grigio antico. Paralumi rivestiti in organza. **es** Estructura metálica con elementos decorativos. Acabado gris antiguo. Pantallas de organza. **pl** Metalowe obramowanie z elementami dekoracyjnymi. Wykończenie antyczne szare. Klosze pokryte organzą. **ru** Арматура и декоративные элементы из металла, цвет - античный серый. Абажуры из органзы.



● Grey / GR



▲
ARM154-PL-01-S
☉ 1xE14 40W
H min: 290, H max: 1752,
D: 180 mm,
□ d1=100 / d2=180 / h=150



▲
ARM326-11-W
 ⚡ 1xE27 40W
 H: 1600, D: 470 mm,
 □ d1=210 / d2=470 / h=290,
 Class 2



▲
ARM326-00-W
 ⚡ 1xE14 40W
 H: 380, D: 220 mm,
 □ d1=120 / d2=220 / h=150,
 Class 2



▲
ARM326-55-W
 ⚡ 5xE14 40W
 H min: 620, H max: 920,
 D: 500 mm,
 □ d1=420 / d2=500 / h=250



▲
ARM326-33-W
 ⚡ 3xE14 40W
 H min: 620, H max: 920,
 D: 440 mm,
 □ d1=360 / d2=440 / h=235



▲
ARM326-01-W
 ⚡ 1xE14 40W
 H: 310, W: 150,
 L: 220 mm,
 □ d1=90 / d2=150 / h=130

OLIVIA

en Metal frame, ivory finish. Pleated satin shades. **de** Metallrahmen, elfenbeinfarbene Ausführung. Plissierte Lampenschirme aus Satin. **fr** Support en métal, finition ivoire. Abat-jours en satin plissé. **it** Struttura in metallo, finitura avorio. Paralumi di raso plissettati. **es** Estructura metálica, acabado marfil. Tonos de satén plisados. **pl** Metalowe obramowanie, wykończenie w kolorze kości słoniowej. Klosze satynowe plisowane. **ru** Арматура из металла, цвет - слоновая кость. Абажуры из плиссированного атласа.



● Ivory / BG



▲
ARM326-05-W
⦿ 5xE14 40W
H min: 700, H max: 1000,
D: 630 mm,
□ d1=90 / d2=150 / h=130





FELICITA

en Metal frame with cream finish. Shades covered in linen with decorative trim. **de** Metallrahmen mit cremefarberer Ausführung. Leinbezogene Lampenschirme mit dekorativen Bordüren. **fr** Support en métal finition crème. Abat-jour en lin garniture décorative. **it** Struttura in metallo con finitura color crema. Paralumi rivestiti in lino con finiture decorative. **es** Estructura metálica con acabado crema. Pantallas de lino con adornos decorativos. **pl** Metalowe obramowanie z wykończeniem kremowym. Klosze pokryte lnem z dekoracyjnym wykończeniem. **ru** Арматура из металла кремового цвета. Абажуры из льна с декоративной тесьмой.



● Beige / BG



▲
ARM029-PL-03-W
 ⚡ 3xE14 40W
 H min: 640, H max: 1400,
 D: 500 mm,
 □ d1=380 / d2=500 / h=185



▲
ARM029-01-W
 ⚡ 1xE14 40W
 H: 290, W: 150, L: 220 mm,
 □ d1=105 / d2=200 / h=155



◀
ARM029-11-W
 ⚡ 1xE14 40W
 H: 410, D: 200 mm,
 □ d1=105 / d2=200 / h=165,
 Class 2



ARM004-01-W
 1xE14 40W
 H: 330, W: 140, L: 290 mm,
 d1=90 / d2=140 / h=135



ARM004-11-W
 1xE14 40W
 H: 460, D: 280 mm,
 d1=140 / d2=280 / h=150,
 Class 2

ARM004-06-W
 6xE14 40W
 H min: 570, H max: 970,
 D: 630 mm,
 d1=90 / d2=140 / h=130,
 2 in 1

MONILE

en Metal frame, White with Gold finish. Decorative pearls and patterned shades. **de** Metallrahmen, weiß und gold lackiert. Dekorative Perlen und gemusterte Lampenschirme. **fr** Support en métal, finition blanc et or. Perles décoratives et abat-jours avec motifs. **it** Struttura in metallo, finitura in bianco e oro. Perle decorative e paralumi fantasia. **es** Estructura de metal, acabado blanco y dorado. Perlas decorativas y tonos estampados. **pl** Metalowe obramowanie, wykończenie białe i złote. Perły dekoracyjne i wzorzyste klosze. **ru** Арматура из металла, цвет - белый с золотом. Декоративные элементы в виде жемчужен. Абажуры из ткани с узором.



White with Gold / WG



ARM004-00-W

☉ 1xE27 40W

H: 1600, D: 390 mm,

▭ d1=190 / d2=390 / h=220,

Class 2



▲
ARM548-05-WG
 ⚙️ 5x E14 40W
 H min: 570, H max: 1570,
 D: 650 mm,
 □ d1=110 / d2=150 / h=110,
 2 in 1



▲
ARM548-01-WG
 ⚙️ 1x E14 40W
 H: 290, W: 150, L: 260 mm,
 □ d1=110 / d2=150 / h=110

ENNA

en Metal frame, White with Gold finish. Crystal pendants and patterned shades. **de** Metallrahmen, weiß und gold lasiert. Anhänger aus Kristall und gemusterte Lampenschirme. **fr** Support en métal, finition blanc et or. Pendentifs en cristal et abat-jours avec motifs. **it** Struttura in metallo, finitura in bianco e oro. Pendenti in cristallo e paralumi testurizzati. **es** Estructura de metal, acabado blanco y dorado. Colgantes de cristal y tonos estampados. **pl** Metalowe obramowanie, wykończenie białe i złote. Kryształowe wisiorki i wzorzyste klosze. **ru** Арматура из металла, цвет - белый с золотом. Декоративные подвески. Абажуры из ткани с узором.



🎨 White with Gold / WG



◀
ARM548-11-WG
⊕ 1xE27 40W
H: 490, D: 270 mm,
□ d1=210 / d2=270 / h=180,
Class 2



ARM143-07-BG
 7xE14 40W
 H min: 590, H max: 1590,
 D: 870 mm,
 □ d1=110 / d2=150 / h=110,
 2 in 1



ARM143-01-BG
 1xE14 40W
 H: 330, W: 150, L: 230 mm,
 □ d1=110 / d2=150 / h=110

LANA

en Metal frame. Painted *crystal pendants. Knitted lampshades. **de** Deckenleuchte mit schwungvollem Metallrahmen und lackierten *Kristall behängen. Lampenschirme im Knitter-Look. **fr** Armature métallique. Pendeloques en *cristal laqué. Abat-jours en tricot. **it** Struttura in metallo. Pendenti in *cristallo verniciati. Diffusori con lavorazione «a maglia». **es** Estructura de metal. Colgantes de *cristal pintados. Pantallas tejidas. **pl** Metalowe obramowanie. Malowane *kryształowe wisiorki. Działe klosze lamp. **ru** Арматура из металла. Подвески из окрашенного хрусталя. Вязаные абажуры.



● Beige / BG





▲
ARM139-06-W
 ⚡ 6x E14 40W
 H min: 480, H max: 1480,
 D: 690 mm,
 □ d1=80 / d2=150 / h=130,
 2 in 1



◀
ARM139-01-W
 ⚡ 1x E14 40W
 H: 300, W: 150, L: 190 mm,
 □ d1=80 / d2=150 / h=130

TORINO

en Metal frame. Decorative elements in the form of clear glass birds. PVC lampshade covered with beige cloth.
de Eleganter Metallrahmen und Dekorelemente in Form von Glasvögelchen. Lampenschirme aus PVC mit beige Stoff bedeckt. **fr** Armature métallique. Éléments décoratifs en forme d'oiseaux en verre transparent. Abat-jours en lin avec des galons de dentelle naturelle. **it** Struttura in metallo. Elementi decorativi in vetro trasparente. Diffusore in PVC rivestito in tessuto beige. **es** Estructura de metal. Elementos decorativos de cristal en forma de pájaros. Pantallas de PVC revestidas de tela beige. **pl** Metalowe obramowanie. Elementy dekoracyjne w postaci przezroczystych, szklanych ptaków. Klosz z PCV pokryty beżową tkaniną. **ru** Арматура из металла. Декоративные элементы в виде птичек из прозрачного стекла. Абажур из ПВХ покрыт бежевой тканью.



○ White Antique / W



◀
ARM001-06-W
 ⚡ 6xE14 40W
 H min: 830, H max: 1030,
 D: 670 mm,
 □ d1=90 / d2=140 / h=130,
 Class 2



◀
ARM001-01-W
 ⚡ 1xE14 40W
 H: 370, W: 140, L: 300 mm,
 □ d1=90 / d2=140 / h=130

PASSARINHO

en Metal frame, crystal pendants and decorative elements. White finish. **de** Metallrahmen, Anhänger aus Kristall und dekorative Elemente. Weiße Ausführung. **fr** Support en métal, pendentifs en cristal et éléments décoratifs. Couleur blanc. **it** Struttura in metallo, pendenti in cristallo ed elementi decorativi. Finitura bianca. **es** Estructura metálica, colgantes de cristal y elementos decorativos. Acabado blanco. **pl** Metalowe obramowanie, kryształowe wisioriki i elementy dekoracyjne. Wykończenie w kolorze białym. **ru** Арматура из металла окрашена в белый цвет. Декоративные элементы и хрустальные подвески.



● Pearl White / W



ARM013-03-W
 3x E14 40W
 H min: 570, H max: 870,
 D: 550 mm,
 □ d1=100 / d2=150 / h=130



ARM013-01-W
 1x E14 40W
 H: 300, W: 150, L: 200 mm,
 □ d1=100 / d2=150 / h=130



ARM013-33-W
 3x E14 40W
 H min: 560, H max: 860,
 D: 450 mm,
 □ d1=370 / d2=450 / h=200



ARM013-11-W
 1x E27 40W
 H: 470, D: 260 mm,
 □ d1=140 / d2=260 / h=150,
 Class 2

BIRD

en Metal frame with polyresin decorative elements. Removable shades covered in linen. Antique white finish. **de** Metallrahmen mit Dekorelementen aus Polyresin. Abnehmbare, mit Leinen bezogene Lampenschirme. **fr** Support en métal avec éléments décoratifs en polyrèsine. Abat-jours en lin. Finition blan antique. **it** Struttura in metallo con elementi decorativi in poliresina. Paralumi rimovibili rivestiti in lino. Finitura bianco antico. **es** Estructura metálica con elementos decorativos de poliresina. Pantallas extraíbles cubiertas de lino. Acabado blanco antiguo. **pl** Metalowe obramowanie z elementami dekoracyjnymi z żywicy poliestrowej. Zdejmowane klosze pokryte lnem. Wykończenie w kolorze białym antycznym. **ru** Арматура сделана из металла, декоративные элементы - из полирезина. Цвет - белый антик. Съёмные абажуры из льна.



○ White Antique / W



▲
ARM013-05-W
☉ 5xE14 40W
H min: 570, H max: 870,
D: 550 mm,
□ d1=100 / d2=150 / h=130



◀
ARM013-22-W
☉ 1xE27 40W
H: 1640, D: 400 mm,
□ d1=240 / d2=405 / h=265,
Class 2





▲
ARM172-08-G
 ⚡ 8xE14 40W
 H max: 530, Hmix: 1030,
 D: 760 mm,
 □ d1=85 / d2=140 / h=110,
 2 in 1



◀
ARM172-01-G
 ⚡ 1xE14 40W
 H: 390, D: 180 mm,
 □ d1=120 / d2=180 / h=150,
 Class 2

BRIONIA

en Metal frame, beige and gold finish. Pleated satin lampshades. **de** Metallrahmen, Ausführung beige und gold. Plissierte Lampenschirme aus Satin. **fr** Support en métal, finition beige et or. Abat-jours en satin plissé. **it** Struttura in metallo, finitura beige e oro. Paralumi di raso plissettati. **es** Estructura de metal, acabado beige y dorado. Pantallas de satén plisadas. **pl** Metalowe obramowanie, wykończenie beżowe i złote. Klosze satynowe plisowane. **ru** Арматура из металла, цвет - бежевый с золотом. Абажуры из плиссированного атласа.



● Beige / BG



▲
ARM172-05-G
 ⚡ 5xE14 40W
 H max: 480, Hmix: 980,
 D: 580 mm,
 □ d1=85 / d2=140 / h=110,
 2 in 1



◀
ARM172-11-G
 ⚡ 1xE14 40W
 H: 1650, W: 384, L: 380 mm,
 □ d1=250 / d2=380 / h=280,
 Class 2



▲
ARM172-02-G
 ⚡ 2xE14 40W
 H: 350, W: 330, L: 200 mm,
 □ d1=85 / d2=140 / h=110



▲
ARM172-22-G
 ⚡ 1xE27 40W
 H: 620, D: 280 mm,
 □ d1=180 / d2=275 / h=220,
 Class 2



TRIUMPH

en Metal frame, cream gold finish. Pleated satin lampshades. Crystal pendants. **de** Metallrahmen, crème-goldfarbenes Dekor. Plissierte Lampenschirme aus Satin. Anhänger aus Kristall. **fr** Support en métal, finition crème doré. Abat-jours en satin plissé. Pendentifs en cristal. **it** Struttura in metallo, finitura crema oro. Paralumi di raso plissettati. Pendenti in cristallo. **es** Acabado dorado crema. Pantallas de satén plisadas. Colgantes de cristal. **pl** Metalowe obramowanie, wykończenie kremowo-złote. Klosze satynowe plisowane. Kryształowe wisiorki. **ru** Арматура из металла, цвет - кремовое золото. Абажуры из плиссированного атласа. Подвески из хрусталя.



 Cream with Gold / BG



▲
ARM288-05-G
☉ 5xE14 40W
H min: 700, H max: 1200,
D: 630 mm,
□ d1=85 / d2=140 / h=110,
2 in 1



◀
ARM288-01-G
☉ 1xE14 40W
H: 420, W: 140, L: 300 mm,
□ d1=85 / d2=140 / h=110



◀
ARM247-08-G
 ⚡ 8xE14 40W
 H max: 790, Hmix: 1190,
 D: 720 mm,
 □ d1=90 / d2=140 / h=130



▲
ARM247-PL-01-G
 ⚡ 1xE14 60W
 H min: 510, H max: 1300,
 D: 300 mm,
 □ d1=200 / d2=300 / h=220



▲
ARM247-06-G
 ⚡ 6xE14 40W
 H max: 760, Hmix: 1160,
 D: 630 mm,
 □ d1=90 / d2=140 / h=130



▲
ARM247-02-G
 ⚡ 2xE14 40W
 H: 390, W: 390, L: 250 mm,
 □ d1=90 / d2=140 / h=130



▲
ARM247-01-G
 ⚡ 1xE14 40W
 H: 390, W: 120, L: 270 mm,
 □ d1=90 / d2=140 / h=130

GRACE

en Metal frame, White with Gold finish. Pleated white organza lampshades. Crystal pendants.

de Metallrahmen, weiß und gold lackiert. Lampenschirme aus weißem plissiertem Organza.

Anhänger aus Kristall. **fr** Support en métal, finition blanc et or. Abat-jours en organza blanc plissé.

Pendentifs en cristal. **it** Struttura in metallo, finitura in bianco e oro. Paralumi in organza bianca

plissettati. Pendenti in cristallo. **es** Estructura de metal, acabado blanco y dorado. Pantallas de

organza blanca plisada. Colgantes de cristal. **pl** Metalowe obramowanie, wykończenie białe i złote.

Plisowane białe abażury z organzy. Kryształowe wisioriki. **ru** Арматура из металла, цвет - белый

с золотом. Абажуры из плиссированной органзы. Подвески из хрусталя.



● White with Gold / WG



▲
ARM247-10-G
☉ 10xE14 40W
H: 1240, D: 850 mm,
□ d1=90 / d2=140 / h=130



◀
ARM247-11-G
☉ 1xE14 40W
H: 1650, D: 380 mm,
□ d1=250 / d2=380 / h=290,
Class 2



▶
ARM247-00-G
☉ 1xE14 40W
H: 560, D: 320 mm,
□ d1=180 / d2=320 / h=190,
Class 2



▲
ARM390-33-W
 ☉ 3xE14 40W
 H max: 650, Hmix: 950,
 D: 550 mm,
 □ d1=450 / d2=550 / h=220



◀
ARM390-00-W
 ☉ 1xE14 40W
 H: 463, D: 220 mm,
 □ d1=150 / d2=220 / h=180,
 Class 2



▲
ARM390-01-W
 ☉ 1xE14 40W
 H: 380, W: 150, L: 260 mm,
 □ d1=90 / d2=150 / h=130

FILOMENA

en Metal frame. Lampshade is decorated with lace. Crystal pendants. **de** Gestell aus Metall mit Kristallglasgehängen. Der Lampenschirm ist mit Spitze verziert. **fr** Armature en métal. Abat-jours décorés de dentelle. Pendentifs en verre de cristal. **it** Struttura in metallo. Diffusore decorato in pizzo. Pendenti di cristallo. **es** Estructura de metal. La pantalla está decorada con un lazo. Colgantes de vidrio de plomo. **pl** Metalowe obramowanie. Lampa ozdobiona koronką. Kryształowe wisiorki. **ru** Арматура из металла. Абажур декорирован кружевом. Подвески из хрусталя.



● Ivory / W



▲
ARM390-05-W
⌀ 5xE14 40W
H max: 660, Hmix: 960,
D: 530 mm,
□ d1=90 / d2=150 / h=130



◀
ARM023-PL-03-S

☉ 3xE14 40W

H min: 520, H max: 1280,

D: 500 mm,

□ d1=380 / d2=500 / h=185



◀
ARM023-01-S

☉ 1xE14 40W

H: 260, W: 160, L: 280 mm,

□ d1=100 / d2=155 / h=155

BOUQUET

en Metal frame with polyresin decorative elements. Removable linen shades. **de** Metallrahmen mit Dekorelementen aus Polyresin. Abnehmbare, mit Leinen bezogene Lampenschirme. **fr** Support en métal avec éléments décoratifs en polyrésine. Abat-jour amovible en lin. **it** Struttura in metallo con elementi decorativi in poliresina. Paralumi in lino removibili. **es** Estructura metálica con elementos decorativos de poliresina. Pantalla de lino. **pl** Metalowe obramowanie z elementami dekoracyjnymi z żywicy poliestrowej. Zdejmowany klosz lniany. **ru** Арматура из металла. Декоративные элементы из полирезина. Съёмные абажуры из льна.



● Grey / GR



▲
ARM369-05-G
 ⚡ 5xE14 40W
 H min: 500, H max: 800,
 D: 550 mm,
 □ d1=470 / d2=550 / h=195



▲
ARM369-33-G
 ⚡ 3xE14 40W
 H min: 570, H max: 870,
 D: 400 mm,
 □ d1=280 / d2=400 / h=267



▲
ARM369-03-G
 ⚡ 3xE27 40W
 H: 230, D: 450 mm,
 □ d1=450 / d2=355 / h=150

LEA

en Metal frame with decorative glass flowers. Pleated organza shades. **de** Metallrahmen mit dekorativen Blumen aus Glas. Plissierte Lampenschirme aus Organza. **fr** Support en métal avec fleurs décoratives en verre. Abat-jour en organza plissé. **it** Struttura in metallo con fiori decorativi di vetro. Paralumi in organza plissettati. **es** Estructura metálica con flores decorativas de vidrio. Pantalla de organza plisada. **pl** Metalowe obramowanie z dekoracyjnymi szklanymi kwiatami. Klosze z plisowanej organzy. **ru** Арматура из металла декорирована стеклянными цветами. Абажуры из плиссированной органзы.



● Pearl White / W



▲
ARM369-01-G
 ⚡ 1xE14 40W
 H: 190, W: 280, L: 140 mm,
 □ d1=195 / d2=265 / h=190



▲
ARM420-03-R
☉ 3xE14 40W
H min: 360, H max: 860,
D: 580 mm,
□ d1=100 / d2=150 / h=130,
2 in 1



▲
ARM420-01-R
☉ 1xE14 40W
H: 280, W: 150, L: 300 mm,
□ d1=100 / d2=150 / h=130

▲
ARM420-02-R
☉ 2xE14 40W
H: 280, W: 390, L: 270 mm,
□ d1=100 / d2=150 / h=130



▲
ARM420-22-R
☉ 1xE14 40W
H: 430, D: 220 mm,
□ d1=130 / d2=220 / h=160,
Class 2

VINTAGE

en Metal frame, antique bronze finish. Pleated satin lampshade. **de** Metallrahmen, antike Bronze Ausführung. Plissierter Lampenschirm aus Satin. **fr** Support en métal, finition bronze antique. Abat-jours en satin plissé. **it** Struttura in metallo, finitura in bronzo antico. Paralume di raso plissettato. **es** Estructura metálica, acabado bronce antiguo. Pantalla de satén plisada. **pl** Metalowe obramowanie, wykończenie antyczne brązowe. Klosz satynowy plisowany. **ru** Арматура из металла, цвет - античная бронза. Абажуры из плиссированного атласа.



● Bronze Antique / BZ



ARM420-05-R
☉ 5x E14 40W
H min: 360, H max: 860,
D: 580 mm,
□ d1=100 / d2=150 / h=130,
2 in 1



▲
ARM365-04-R
 ☉ 4xE27 40W
 H: 360, D: 540 mm,
 □ d1=400 / d2=520 / h=180



◀
ARM365-01-R
 ☉ 1xE14 40W
 H: 190, W: 280, L: 150 mm,
 □ d1=200 / d2=280 / h=180

LETIZIA

en Metal frame with ceramic decors. Transparent pleated organza shades. **de** Metallrahmen mit dekorativen Elementen aus Keramik. Transparente plissierte Lampenschirme aus Organza. **fr** Support en métal avec décors en céramique. Abat-jour en organza plissé transparent. **it** Struttura in metallo con elementi decorativi in ceramica. Paralumi in organza plissettata trasparente. **es** Estructura metálica con decoraciones cerámicas. Pantalla de organza plisada transparente. **pl** Metalowa obramowanie z dekorami ceramicznymi. Przezroczyste plisowane klosze z organz. **ru** Арматура из металла. Декоративные элементы из керамики. Абажуры из плиссированной прозрачной органзы.



● Bronze / BZ



▲
ARM365-05-R
☞ 5x E14 40W
H min: 640, H max: 1040,
D: 530 mm,
☐ d1=420 / d2=520 / h=310



▲
 ARM337-05-R
 ⚡ 5xE14 60W
 H min: 560, H max: 860,
 D: 560 mm



◀
 ARM337-02-R
 ⚡ 2xE14 60W
 H: 190, W: 300, L: 200 mm

PERLA

en Metal frame, cream gold finish. **de** Metallrahmen, creme-goldfarbenes Dekor. **fr** Armature en métal, finition dorée crème. **it** Struttura in metallo, finitura crema oro. **es** Estructura metálica, acabado dorado crema. **pl** Metalowe obramowanie, wykończenie kremowo-złote. **ru** Арматура из металла, цвет - кремовое золото.



● Cream with Gold / R



▲
ARM337-07-R
7x E14 60W
H min: 570, H max: 870,
D: 660 mm





◀
H428-PL-01-WG
 ⚡ 1xE14 40W
 H min: 340, H max: 1220,
 D: 245 mm,
 ▢ d=245 / h=195

▲
H428-PL-03-WG
 ⚡ 3xE14 40W
 H min: 330, H max: 1210,
 D: 400 mm,
 ▢ d=400 / h=205



◀
H428-WL-01-WG
 ⚡ 1xE14 40W
 H: 240, W: 190, L: 120 mm,
 ▢ h=160



◀
H428-TL-01-WG
 ⚡ 1xE14 40W
 H: 505, D: 275 mm,
 ▢ d=275 / h=175,
 Class 2

FARN

en Metal frame, gold finish. Fabric covered shade with metal decor. **de** Metallrahmen, vergoldet. Stoffbezogener Lampenschirm mit Metalldekor. **fr** Armature métallique, finition dorée. Abat-jour couvert de tissu avec décor en métal. **it** Struttura in metallo, finitura in oro. Paralume rivestito in tessuto con decoro in metallo. **es** Estructura de metal, acabado dorado. Pantalla cubierta de tela con decoración de metal. **pl** Metalowe obramowanie, wykończenie w kolorze złotym. Abażur pokryty tkaniną z dekiem metalowym. **ru** Арматура из металла окрашена в золотой цвет. Абажур из ПВХ покрыт хлопком и украшен декоративным металлическим элементом.



● Gold / G



▲
H223-WL-02-G
☞ 2xE14 40W
H: 200, W: 272, L: 130 mm,
□ d=272 / h=200

▲
H223-WL-01-G
☞ 1xE14 40W
H: 239, W: 122, L: 101 mm,
□ d=120 / h=240



▲
H223-PL-05-G
☞ 5xE27 60W
H: 239, D: 570 mm,
□ d=539 / h=185



▲
H223-PL-03-G
☞ 3xE27 60W
H: 239, D: 430 mm,
□ d=399 / h=185

MESSINA

en Metal frame with stencil decor. Linen covered shade. **de** Metallrahmen mit Schablonendekor. Lampenschirm mit Leinenbezug. **fr** Armature métallique avec décor Stencil. Abat-jours en lin. **it** Struttura in metallo con decoro stencil. Paralume rivestito in lino. **es** Estructura de metal. Aplicación del troquelado. Pantalla de PVC revestida de lino. **pl** Metalowe obramowanie z wzorem stencil. Abażur pokryty lnem. **ru** Металлическая арматура. Использование трафаретного узора. Абажур из ПВХ покрыт льном.



● Gold / G



ARM959-PL-06-G

☉ 6xE14 40W

H min: 320, H max: 1200,

D: 555 mm,

□ d=495 / h=160



ARM959-PL-04-G

☉ 4xE14 40W

H min: 320, H max: 1200,

D: 455 mm,

□ d=395 / h=160



ARM959-WL-02-G

☉ 2xE14 40W

H: 135, W: 330, L: 120 mm,

Class 2

BURGEON

en Metal frame with stencil decor. Bronze finish. Fabric covered shade. **de** Metallrahmen mit Schablonendekor. Bronze-Ausführung. Lampenschirm mit Stoffbezug. **fr** Armature en métal avec décor Stencil. Finition bronze. Abat-jour en tissu. **it** Struttura in metallo con decoro stencil. Finitura in bronzo. Paralume rivestito in tessuto. **es** Estructura de metal. Aplicación del troquelado. Pantalla de tela. **pl** Metalowe obramowanie z wzorem stencil. Wykończenie w kolorze brązu. Abażur pokryty tkaniną. **ru** Арматура из металла, цвет - латунь. Использование трафаретного узора. Абажур из ткани.



● Bronze / BZ



◀
H601PL-03BS
 ⚡ 3xE14 40W
 H: 700, D: 480 mm,
 □ d=480 / h=200



◀
H601PL-01BS
 ⚡ 1xE27 60W
 H: 520, D: 320 mm,
 □ d=320 / h=160

VALENCIA

en Metal frame. Decorative elements in the base made of metal. PVC lampshade covered in cloth. **de** Elegante Leuchte mit Metallrahmen und Zierelementen an der Basis. PVC-Lampenschirm mit Stoffbezug. **fr** Structure métallique. Éléments décoratifs en métal à la base. Abat-jour en PVC recouvert de tissu. **it** Struttura in metallo. Elementi decorativi sulla base in metallo. Diffusore in PVC rivestito di tessuto. **es** Estructura de metal. Base con elementos ornamentales realizados en metal. Pantalla de PVC revestida de tela. **pl** Metalowe obramowanie. Elementy dekoracyjne w podstawie wykonane z metalu. Klosz z PCV pokryty tkaniną. **ru** Каркас из металла. Декоративные элементы в основании из металла. Абажур из ПВХ покрыт тканью.



 Brass / BS



H034-PL-01-R

☉ 1xE14 40W

H min: 350, H max: 1780,

D: 180 mm,

□ d1=100 / d2=180 / h=160



H034-WL-02-R

☉ 2xE14 40W

H: 410, W: 310, L: 120 mm,

□ h=180

CIPRESSO

en Metal frame, decorative wooden elements. Linen covered shade. **de** Metallrahmen, dekorative Elemente aus Holz. Lampenschirme mit Leinenbezug. **fr** Support en métal, éléments décoratifs en bois, Abat-jour couvert en lin. **it** Struttura in metallo, elementi decorativi in legno. Paralume rivestito in lino. **es** Estructura metálica, elementos decorativos de madera. Pantalla de lino. **pl** Metalowe obramowanie, dekoracyjne elementy drewniane. Abażur pokryty lnem. **ru** Арматура из металла. Декоративные элементы из дерева. Абажур из ПВХ покрыт льном.



● Beige / R





▲
H260-03-N
 ⚡ 3xE14 40W
 H min: 590, H max: 1415,
 D: 464 mm,
 □ d=464 / h=160



▲
H260-00-N
 ⚡ 1xE27 60W
 H min: 535, H max: 1360,
 D: 230 mm,
 □ d=233 / h=160



◀
H260-02-N
 ⚡ 2xE14 40W
 H: 457, W: 120, L: 113 mm,
 □ h=457

VENERA

en Metal frame with stencil decor. Brass finish. Fabric covered shade. **de** Metallrahmen mit Schablonendekor. Messing-Ausführung. Lampenschirm mit Stoffbezug. **fr** Armature en métal avec décor Stencil. Finition en laiton. Abat-jour en tissu. **it** Struttura in metallo con decoro stencil. Finitura in ottone. Paralume rivestito in tessuto. **es** Estructura de metal con decoración de plantilla. Acabado en latón. Pantalla cubierta de tela. **pl** Metalowe obramowanie z wzorem stencil. Wykończenie w kolorze miedzianym. Abażur pokryty tkaniną. **ru** Арматура из металла с трафаретным декором, цвет - латунь. Абажур из ткани.



● Brass / BS



▲
H260-05-N
☞ 5xE27 60W
H: 243, D: 500 mm,
□ d=430 / h=150



◀
H899-11-R/W
⚡ 1xE14 60W
H min: 570, H max: 770,
D: 180 mm,
Class 2



◀
H899-01-W/R
⚡ 1xE14 60W
H: 270, W: 180, L: 100 mm

RUSTIKA

en Forged iron frame with stencil pattern, antique finish. **de** Geschmiedeter Eisenrahmen mit Schablonenmuster, antike Ausführung. **fr** Armature en fer forgé avec motif Stencil. Finition antique. **it** Struttura in ferro battuto con fantasia stencil, finitura anticata. **es** Estructura de hierro forjado con patrón de plantilla, acabado antiguo. **pl** Kuta żelazna rama z wzorem stencil, wykończenie antyczne. **ru** Кованый каркас из железа. Использование индивидуального трафаретного узора.



● Cream / W

● Brown / BR





◀ H356-CL-03-CH/BZ
 ⚡ 3xE27 60W
 H: 192, W: 352, L: 304 mm,
 □ d1=40 / d2=328 / h=130

ZEIL

en Metal frame with transparent glass slabs. **de** Metallrahmen mit transparenten Glasscheiben.
fr Armature métallique avec plaques de verre transparentes. **it** Struttura in metallo con lastre di vetro trasparente. **es** Estructura metálica con losas de vidrio transparente. **pl** Metalowe obramowanie z przezroczystymi płytami szklanymi. **ru** Арматура из металла. Плафон из прозрачного стекла.



● Chrome / CH ● Bronze / BZ



◀ H353-TL-01-BZ/N/W
 1xE14 60W
 H: 442, W: 251, L: 564 mm,
 □ d1=60 / d2=80 / h=126

SENNA

en Metal frame. Branded engraving. Glass lampshade. **de** Metallrahmen in den Farben Chrom, Bronze-Antik und Pastellblau erhältlich. Mit Firmengravur und Lampenschirmen aus Glas. **fr** Structure en métal. Gravure de marque. Diffuseur en verre. **it** Struttura in metallo. Diffusore in vetro con effetto rustico. **es** Estructura de metal, disponible en 3 colores. Difusor de vidrio con efecto rústico. **pl** Metalowe obramowanie. Grawerunek markowy. Klosz szklany. **ru** Арматура из металла. Фирменная гравировка. Плафон из стекла.



Bronze / BZ
 White / W
 Nickel / N



▲
H099-03-B
☉ 3x E14 40W
H min: 310, H max: 1270,
W: 620, L: 120 mm



▲
H099-05-B
☉ 5x E14 40W
H min: 310, H max: 1270,
D: 320 mm

RAPPE

en Metal frame. Lampshade made of glass and rattan. **de** Schwarze Metallkonstruktion. Flaschenförmige Lampenschirme aus Glas, mit Rattan umflochten. **fr** Structure en métal. Abat-jours en verre recouverts de rotin. **it** Struttura in metallo, diffusori in vetro e rivestimento in rattan. **es** Estructura de metal, difusor de vidrio revestido de ratán. **pl** Metalowe obramowanie. Lampa wykonana jest ze szkła i rattanu. **ru** Каркас из металла. Плафон выполнен из стекла и ротанга.



● Black / B





▲
H300-03-G
 ⚡ 3x E14 40W
 H: 83, D: 370 mm,
 □ h=39

LANTANA

en Metal and polyresin frame, gold finish. Frosted glass diffuser. **de** Rahmen aus Metall und Polyresin, vergoldet. Diffusor aus mattiertem Glas. **tr** Armature en métal et polyrésine, finition dorée. Diffuseur en verre dépoli. **it** Struttura in metallo e poliresina, finitura oro. Diffusore in vetro acidato. **es** Estructura de metal y poliresina, acabado dorado. Difusor de vidrio esmerilado. **pl** Obramowanie z metalu i żywicy poliestrowej, wykończenie w kolorze złotym. Dyfuzor szklany oszroniony. **ru** Арматура выполнена из металла и полирезина, цвет - античное золото. Плафон из матового стекла.



● Pearl Gold / G



▲
H300-04-G
☞ 4xE14 40W
H: 95, D: 555 mm,
□ h=51



◀
H301-04-G
 ⚡ 4xE14 40W
 H: 103, D: 560 mm,
 □ h=72



◀
H301-03-G
 ⚡ 3xE14 40W
 H: 82, D: 362 mm,
 □ h=62

LAMAR

en Metal frame, cream gold finish. Frosted glass shade. **de** Metallrahmen, crème-goldfarbenes Dekor. Mattierte Glasabdeckung. **fr** Armature métallique, finition dorée crème. Abat-jour en verre dépoli. **it** Struttura in metallo, finitura crema oro. Diffusore in vetro acidato. **es** Estructura metálica, acabado dorado crema. Pantalla de vidrio esmerilado. **pl** Metalowe obramowanie, wykończenie w kolorze kremowo-złotym. Szroniony odcień szkła. **ru** Арматура из металла, цвет - кремовое золото. Плафон из матового стекла.



● Cream with Gold / G



▲
H301-01-G
 ⚡ 1xE14 40W
 H: 280, W: 280, L: 120 mm,
 □ d=280 / h=170





▲
H001CL-05BS
 ⚡ 5xE14 40W
 H: 505, D: 780 mm,
 □ d1=125 / d2=140 / h=170



◀
H001TL-01BS
 ⚡ 1xE27 60W
 H: 600, D: 165 mm,
 □ d1=125 / d2=165 / h=250,
 Class 2



◀
H001WL-01BS
 ⚡ 1xE14 40W
 H: 280, W: 140, L: 190 mm,
 □ d1=125 / d2=140 / h=170

ZARAGOZA

en Metal frame, polished brass finish. White fabric shades. **de** Metallrahmen, poliertes Messing-Ausführung. Lampenschirme mit weißem Stoffbezug. **fr** Support en métal, finition en laiton poli. Abat-jours en tissu blanc. **it** Struttura in metallo, finitura in ottone lucido. Paralumi in tessuto bianco. **es** Estructura de metal, acabado de latón pulido. Tonos de tela blanca. **pl** Metalowe obramowanie, wykończenie o wyglądzie polerowanego miedzi. Białe klosze z tkaniny. **ru** Арматура из металла, цвет - никель. Абажуры покрыты белой тканью.



● Brass / BS



▲
H001CL-07BS
⊕ 7x E14 40W
H: 505, D: 880 mm,
□ d1=125 / d2=140 / h=170



◀
H006PL-03G
 ⚡ 3xE14 40W
 H min: 350, H max: 1300,
 D: 680 mm,
 □ d=170 / h=120



◀
H006WL-01G
 ⚡ 1xE14 40W
 H: 490, W: 280, L: 140 mm,
 □ d=280 / h=160



◀
H006TL-01G
 ⚡ 1xE27 40W
 H: 410, D: 250 mm,
 □ d=250 / h=175,
 Class 2

LUXE

en Metal frame with decorative glass elements. Fabric covered lampshades. **de** Metallrahmen mit dekorativen Elementen aus Glas. Stoffbezogene Lampenschirme. **fr** Support en métal avec éléments décoratifs en verre. Abat-jours recouverts de tissu. **it** Struttura in metallo con elementi decorativi in vetro. Paralumi rivestiti in tessuto. **es** Estructura metálica con elementos decorativos de vidrio. Pantallas cubiertas de tela. **pl** Metalowe obramowanie z dekoracyjnymi elementami szklanymi. Klosze pokryte tkaniną. **ru** Арматура из металла. Декоративные элементы из стекла. Абажур из ПВХ покрыт тканью.



● Gold Antique / G



▲
H006PL-05G
⊕ 5x E14 40W
H min: 350, H max: 1300,
D: 730 mm,
□ d=170 / h=120



H007PL-04G
 ⚡ 4xE14 40W
 H min: 395, H max: 1310,
 D: 445 mm,
 □ d=445 / h=190



H007WL-01G
 ⚡ 1xE14 40W
 H: 300, W: 180, L: 190 mm,
 □ d=140 / h=175

ANNA

en Metal frame, antique gold finish. Creamy fabric covered shades. **de** Metallrahmen, Ausführung in Antik-Gold. Lampenschirme mit cremefarbenem Stoffbezug. **fr** Support en métal, finition or antique. Abat-jours couverts de tissu teinté crème. **it** Struttura in metallo, finitura in oro antico. Paralumi rivestiti di tessuto color crema. **es** Estructura de metal, acabado dorado antiguo. Tonos cubiertos de tela color crema. **pl** Metalowe obramowanie, wykończenie w kolorze antycznym złotym. Klosze pokryte kremową tkaniną. **ru** Арматура из металла, цвет - античное золото. Абажуры из кремовой ткани.



 Gold Antique / G



▲
H007PL-05G
5x E14 40W
H min: 425, H max: 1340,
D: 620 mm,
□ d=620 / h=230



▲
H004CL-05BG
 ⦿ 5xE14 40W
 H: 370, D: 710 mm,
 □ d=120 / h=150



▲
H005WL-01BG
 ⦿ 1xE14 40W
 H: 420, W: 150, L: 200 mm,
 d=120 / h=150



▲
H004WL-01BG
 ⦿ 1xE14 40W
 H: 250, W: 120, L: 200 mm,
 d=120 / h=150

VITTORIA

en Round metal frame with cream gold finish. Cream fabric shades. **de** Runder Metallrahmen mit crème-goldfarbenem Dekor. Crème-Stoffschirme. **fr** Support en métal rond avec une finition or crème. Abat-jours en tissu crème. **it** Struttura rotonda in metallo con finitura crema oro. Paralumi in tessuto color crema. **es** Estructura redonda de metal con acabado dorado crema. Tonos de tela crema. **pl** Okrągła metalowa rama z wykończeniem w kolorze kremowo-złotym. Klosze z tkaniny kremowej. **ru** Круглый каркас из металла, цвет - кремовое золото. Абажуры покрыты кремовой тканью.



● Cream with Gold / G



▲
H004CL-07BG
☞ 7xE14 40W
H: 430, D: 790 mm,
☐ d=120 / h=150



H357-PL-03-BG

☉ 3xE14 40W

H min: 540, H max: 1300,

D: 480 mm,

□ d=480 / h=170



H357-WL-01-BG

☉ 1xE14 40W

H: 240, W: 160, L: 210 mm,

□ d=160 / h=120

CABLE

en Metal frame with delicate wire pattern decoration. Lampshades covered with transparent organza.

de Metallrahmen mit filigraner Drahtmuster-Verzierung. Lampenschirme mit transparentem Organza bezogen.

fr Support en métal, décoré. Fils décoratifs. Abat-jours en organza transparent. **it** Struttura in metallo con fili

decorativi. Paralumi in organza trasparente. **es** Estructura de metal adornada con patrones e hilos metálicos.

Pantallas de PVC revestidas de organza transparente. **pl** Metalowe obramowanie ozdobione wzorem drucianym.

Przezroczyste organzowe klosze. **ru** Арматура из металла украшена узором и декоративными проводами.

Абажуры из прозрачной органзы.



● Brown / BR



▲
H357-PL-08-BG
⊕ 8xE14 40W
H min: 640, H max: 1400,
D: 800 mm,
□ d=160 / h=120



▲
H018-PL-06-NG
 ⚡ 6xE14 40W
 H max: 840, Hmix: 1040,
 D: 680 mm,
 □ d=140 / h=120

BIENCE

en Metal frame, antique silver finish. Art deco style lampshades. Crystal pendants. **de** Metallrahmen, Antik-Silber Ausführung. Lampenschirme im Art-Deco-Stil. Anhänger aus Kristall. **fr** Support en métal, fini argent antique. Abat-jours de style Art déco. Pendentifs en cristal. **it** Struttura in metallo, finitura argento antico. Paralumi in stile Art Deco. Pendenti in cristallo. **es** Estructura de metal, acabado plateado antiguo. Pantallas de estilo Art Deco. Colgantes de cristal. **pl** Metalowe obramowanie, wykończenie w kolorze antycznym srebrnym. Klosze w stylu Art Deco. Kryształowe wisiorki. **ru** Арматура из металла, цвет - античное серебро. Абажуры в стиле ар-деко. Подвески из хрусталя.



● Silver Antique / S



◀
H018-PL-08-NG
 ⚡ 8x E14 40W
 H max: 880, Hmix: 1040,
 D: 820 mm,
 □ d=140 / h=120



◀
H018-FL-01-NG
 ⚡ 1x E27 40W
 H: 1650, D: 430 mm,
 □ d=430 / h=250,
 Class 2



◀
H018-TL-01-NG
 ⚡ 1x E14 40W
 H: 460, W: 260, L: 260 mm,
 □ d1=155 / d2=260 / h=140,
 Class 2



▲
H018-WL-01-NG
 ⚡ 1x E14 40W
 H: 380, W: 140, L: 240 mm,
 □ d=140 / h=120



▲
 H009PL-08G
 ⚡ 8xE14 40W
 H min: 835, H max: 1435,
 D: 875 mm

BOWI

en Exceptional design of metal frame in gold. **de** Außergewöhnliches Design des Metallrahmens in Gold. **fr** Armature dorée au design exceptionnel. **it** Struttura in metallo dorata. Design innovativo. **es** Estructura de metal dorado con diseño insólito. **pl** Wyjątkowa konstrukcja metalowej ramy w kolorze złotym. **ru** Необычный дизайн каркаса из металла золотого цвета.



● Gold / G



▲
H009PL-06G
⦿ 6xE14 40W
H min: 585, H max: 1385,
D: 656 mm



◀
H002PL-06G
 ⚡ 6xG9 28W
 H: 740, D: 540 mm,
 □ d=80 / h=190



◀
H002WL-02G
 ⚡ 2xG9 28W
 H: 300, W: 300, L: 140 mm,
 □ d=80 / h=190



◀
H002WL-01G
 ⚡ 1xG9 28W
 H: 300, W: 100, L: 120 mm,
 □ d=80 / h=190

LITA

en Metal frame. Lampshade of amber glass in unusual shape. **de** Metallrahmen. Lampenschirm aus bernsteinfarbenen Glas in ungewöhnlicher Form. **fr** Armature en métal. Abat-jour en verre ambré de forme inhabituelle. **it** Struttura in metallo. Diffusore in vetro ambrato dalla forma insolita. **es** Estructura de metal. Tulipa de vidrio de color ambarino de la forma insólita. **pl** Metalowe obramowanie. Lampa z bursztynowego szkła o nietypowym kształcie. **ru** Арматура из металла. Плафон из стекла янтарного цвета необычной формы.



● Gold Matt / G





◀
RC855-PL-06-R
 ⚡ 6xE14 40W
 H min: 750, H max: 1080,
 D: 800 mm,
 □ d1=90 / d2=160 / h=120



◀
RC855-WL-01-R
 ⚡ 1xE14 40W
 H: 360, W: 160, L: 300 mm
 □ d1=90 / d2=160 / h=120



◀
ARM855-TL-01-R
 ⚡ 1xE14 40W
 H: 480, D: 260 mm,
 □ d1=210 / d2=260 / h=180,
 Class 2

MURANO

en Metal frame, bronze finish. Champagne colour crystal components and pendants. **de** Metallrahmen, Bronze-Ausführung. Champagnerfarbene Kristallkomponenten und Anhänger. **fr** Support en métal, finition bronze. Composants et pendentifs en cristal de couleur Champagne. **it** Struttura in metallo, finitura in bronzo. Componenti e pendenti in cristallo color champagne. **es** Estructura metálica, acabado en bronce. Componentes y colgantes de cristal color champán. **pl** Metalowe obramowanie w kolorze brązu. Elementy kryształowe i wisiorki w kolorze szampana. **ru** Арматура из металла, цвет - бронза. Декоративные хрустальные элементы цвета «шампань» и подвески.



● Bronze / BZ





RC0100-PL-05-R

5xE14 60W

H min: 700, H max: 940,

D: 640 mm,

□ d1=100 / d2=180 / h=120



RC0100-WL-01-R

1xE14 60W

H: 325, W: 180, L: 252 mm,

□ d1=100 / d2=180 / h=120



RC0100-TL-01-R

1xE14 60W

H: 500, D: 310 mm,

□ d1=110 / d2=310 / h=220
Class 2

CHESTER

en Metal frame brass finish. Brown fabric covered lampshades. **de** Metallrahmen, Messing-Ausführung. Lampenschirme mit braunem Stoff bezogen. **fr** Support en métal fini laiton. Abat-jours recouverts de tissu marron. **it** Struttura in metallo, finitura in ottone. Paralumi rivestiti in tessuto marrone. **es** Estructura metálica acabado latón. Pantallas cubiertas de tela marrón. **pl** Metalowe obramowanie w kolorze miedzi. Klosze pokryte tkaniną brązową. **ru** Арматура из металла, цвет - латунь. Абажуры покрыты коричневой тканью.



● Brass / BS





◀
RC247-PL-08-R
☉ 8xE14 60W
H min: 790, H max: 1190,
D: 720 mm



▲
RC247-PL-06-R
☉ 6xE14 60W
H min: 760, H max: 1160,
D: 630 mm



▲
RC247-WL-02-R
☉ 2xE14 60W
H: 390, W: 390, L: 250 mm



◀
RC247-WL-01-R
☉ 1xE14 60W
H: 390, W: 120, L: 270 mm



▲
RC247-PL-01-R
☉ 1xE14 60W
H min: 610, H max: 1270,
D: 300 mm,
□ d1=200 / d2=300 / h=220



▲
RC247-TL-01-R
☉ 1xE14 40W
H: 550, D: 320 mm,
□ d1=180 / d2=320 / h=190,
Class 2

GRACE

en Metal frame, white and brass finish. Pleated white organza lampshades. Crystal pendants.
de Metallrahmen, weiß und messing lackiert. Lampenschirme aus weißem plissiertem Organza.
Anhänger aus Kristall. **fr** Support en métal, finition blanc et laiton. Abat-jours en organza blanc
plissé. Pendentifs en cristal. **it** Struttura in metallo, finitura in ottone. Paralumi in organza bianca
plissettati. Pendenti in cristallo. **es** Estructura de metal, acabado blanco y latón. Pantallas de
organza blanca plisada. Colgantes de cristal. **pl** Metalowe obramowanie, wykończenie białe i
mosiądz. Plisowane białe abażury z organzy. Kryształowe wisiorki. **ru** Арматура из металла, цвет -
белый с латунью. Абажуры из плиссированной органзы. Подвески из хрусталя.



☉ White with Gold / WG



▲
RC247-PL-10-R
⊙ 10xE14 60W
H min: 840, H max: 1240,
D: 850 mm



◀
RC247-FL-01-R
⊙ 1xE14 40W
H: 1650, D: 380 mm,
□ d1=250 / d2=380 / h=290,
Class 2





RC015-PL-01-G

1xE27 60W

H min: 320, H max: 800,

D: 120 mm,

□ d=120 / h=137

SHERBORN

en Metal frame with stencil pattern. Acrylic diffuser. **de** Metallrahmen mit Schablonenmuster. Diffusor aus Acryl. **fr** Support en métal, avec ornements patinés. Diffuseur acrylique. **it** Struttura in metallo con fantasia stencil. Diffusore in acrilico. **es** Estructura metálica con patrón de plantilla. Difusor acrílico. **pl** Metalowe obramowanie z wzorem stencil. Dyfuzor akrylowy. **ru** Арматура из металла. Использование трафаретного узора. Плафон из акрила.



● Bronze Antique / BZ



PALACE

en Metal frame, brass finish. Crystals of different sizes and shapes. **de** Metallrahmen, Messing-Ausführung. Kristalle in verschiedenen Größen und Formen. **fr** Support en métal, finition en laiton. Cristaux de différentes tailles et formes. **it** Struttura in metallo, finitura in ottone. Cristalli di diverse dimensioni e forme. **es** Estructura metálica, acabado en latón. Cristales de diferentes tamaños y formas. **pl** Metalowe obramowanie w kolorze miedzi. Kryształy o różnych rozmiarach i kształtach. **ru** Арматура из металла, цвет - латунь. Декоративные элементы из хрусталя различных размеров и форм.



● Brass / BS



▲
DIA890-CL-18-G
☉ 18xE27 60W
Hmin: 625, Hmax: 688,
D: 1000 mm



◀
DIA890-CL-06-G
☉ 6xE27 60W
H min: 380, H max: 445,
D: 500 mm



◀
DIA890-CL-05-G
☉ 5xE27 60W
Hmin: 370, Hmax: 435,
D: 400 mm



▲
DIA891-CL-14-G
⚡ 14xE27 60W
Hmin: 500, Hmax: 567,
D: 800 mm



▲
DIA890-CL-10-G
⚡ 10xE27 60W
Hmin: 377, Hmax: 442,
D: 800 mm



▲
DIA890-WL-01-G
⚡ 1xE27 60W
H: 184, W: 170, L: 119 mm



▲
DIA100-CL-16-G/N
⚡ 16x E14 60W
H: 350, D: 605 mm

BASFOR

en Metal frame, diamond-shaped crystals. **de** Metallrahmen, diamantförmige Kristalle. **fr** Monture en métal, cristaux en forme de losange. **it** Struttura in metallo, cristalli a forma di diamante. **es** Estructura de metal, cristales en forma de diamante. **pl** Metalowe obramowanie, kryształy w kształcie diamentu. **ru** Арматура из металла, хрусталь ромбовидной огранки.



● Gold Antique / G

● Nickel Antique / N



▲
DIA100-CL-12-G/N
☉ 12xE14 60W
H: 320, D: 460 mm



◀
DIA100-CL-03-G/N
☉ 3xE14 60W
H: 205, D: 300 mm



◀
DIA100-WL-02-N/G
☉ 2xE14 60W
H: 125, W: 255, L: 150 mm



▲
DIA700-CL-12-G
⊕ 12xE14 60W
H: 340, D: 650 mm

OTTILIA

en Metal frame, gold finish. Crystals of different sizes and shapes. **de** Metallrahmen, vergoldet. Kristalle in verschiedenen Größen und Formen. **fr** Support en métal, finition or. Cristaux de différentes tailles et formes. **it** Struttura in metallo, finitura oro. Cristalli di diverse dimensioni e forme. **es** Estructura de metal, acabado dorado. Cristales de diferentes tamaños y formas. **pl** Metalowe obramowanie, wykończenie w kolorze złotym. Kryształy o różnych rozmiarach i kształtach. **ru** Арматура из металла, цвет - золото. Декоративные элементы из хрусталя различных размеров и форм.



● Gold / G



▲
DIA700-CL-06-G
⚡ 6xE14 60W
H: 260, D: 435 mm



▲
DIA700-CL-03-G
⚡ 3xE14 60W
H: 235, D: 320 mm



▲
DIA700-WL-02-G
⚡ 2xE14 60W
H: 130, D: 250, L: 130 mm



◀
DIA750-TT40-WG
 ⚡ 7xE14 60W
 H min: 810, H max: 1701,
 D: 400 mm



▲
DIA750-PT50-WG
 ⚡ 6xE14 60W
 H: 370, D: 500 mm



▲
DIA750-WB01-WG
 ⚡ 2xE14 60W
 H: 185, W: 230, L: 140 mm

BELLA

en Metal frame, gold finish. Crystals of different sizes and shapes. **de** Metallrahmen, vergoldet. Kristalle in verschiedenen Größen und Formen. **fr** Monture en métal, finition dorée. Cristaux de différentes tailles et formes. **it** Struttura in metallo, finitura oro. Cristalli di diverse dimensioni e forme. **es** Estructura de metal, acabado dorado. Cristales de diferentes tamaños y formas. **pl** Metalowe obramowanie, wykończenie w kolorze złotym. Kryształy o różnych rozmiarach i kształtach. **ru** Арматура из металла, цвет - золото. Декоративные элементы из хрусталя различных размеров и форм.



● Gold / G



▲
DIA750-TT50-WG
8x E14 60W
H min: 850, H max: 1741,
D: 500 mm



▲
DIA522-CL-07-G
☞ 7xE14 60W
H: 500, D: 420 mm



◀
DIA522-WL-01-G
☞ 1xE14 60W
H: 205, W: 170, L: 105 mm

CASCADE

en Metal frame, brass tape, antique gold finish. Crystal pendants. **de** Metallrahmen, Band aus Messing, Antik-Gold-Ausführung. Anhänger aus Kristall. **fr** Support en métal, ruban en laiton, finition or antique. Pendentifs en cristal. **it** Struttura in metallo, nastro di ottone, finitura oro antico. Pendenti in cristallo. **es** Estructura metálica, aro de latón, acabado dorado antiguo. Colgantes de cristal. **pl** Metalowe obramowanie, taśma mosiężna, wykończenie antyczne złote. Kryształowe wisiorki. **ru** Арматура из металла, цвет - золото. Латунная лента. Подвески из хрусталя.



● Gold / G

● Gold Antique / G



◀
DIA522-CL-12-G
⊕ 12xE14 60W
H: 1000, D: 420 mm



DIA004-08-G

8x E14 60W

H min: 560, H max: 960,

D: 760 mm, 2 in 1

SEVILLA

en Metal frame, gold finish. Crystal pendants. **de** Metallrahmen, vergoldet. Anhänger aus Kristall.

fr Support en métal, finition dorée. Pendentifs en cristal. **it** Struttura in metallo, finitura oro. Pendenti

in cristallo. **es** Estructura de metal, acabado dorado. Colgantes de cristal. **pl** Metalowe obramowanie,

wykończenie w kolorze złotym. Kryształowe wisiorki. **ru** Арматура из металла, цвет - золото.

Декоративные подвески из хрусталя.



● Gold / G



◀
DIA004-06-G
⦿ 6x E14 60W
H min: 560, H max: 960,
D: 620 mm, 2 in 1



◀
DIA004-01-G
⦿ 1x E14 60W
H: 360, W: 120, L: 270 mm



DIA003-PT50-G

 16xE14 60W

H: 1750, D: 515 mm

NIAGARA

en Metal frame, gold finish. Crystals of different sizes and shapes. **de** Metallrahmen, vergoldet. Kristalle in verschiedenen Größen und Formen. **fr** Support en métal, finition or. Cristaux de différentes tailles et formes. **it** Struttura in metallo, finitura oro. Cristalli di diverse dimensioni e forme. **es** Estructura de metal, acabado dorado. Cristales de diferentes tamaños y formas. **pl** Metalowe obramowanie, wykończenie w kolorze złotym, kryształy o różnych rozmiarach i kształtach. **ru** Арматура из металла, цвет - золото. Декоративные элементы из хрусталя различных размеров и форм.

 Gold / G



▲
DIA120-09-G
⊕ 9xE14 40W
H: 270, D: 510 mm



◀
DIA120-06-G
⊕ 6xE14 40W
H: 240, D: 410 mm

KAROLINA

en Metal frame, gold finish. Crystal pendants of different sizes and shapes. **de** Metallrahmen, vergoldet. Anhänger aus Kristall in verschiedenen Größen und Formen. **fr** Monture en métal, finition dorée. Pendentifs en cristal de différentes tailles et formes. **it** Struttura in metallo, finitura oro. Pendenti in cristallo di diverse dimensioni e forme. **es** Estructura de metal, acabado dorado. Colgantes de cristal de diferentes tamaños y formas. **pl** Metalowe obramowanie, wykończenie w kolorze złotym. Kryształowe wisiorki o różnych rozmiarach i kształtach. **ru** Арматура из металла, цвет - золото. Декоративные подвески из хрусталя различных размеров и форм.



● Gold / G



▲
C906-CL-04-W/R
⊕ 4xE27 40W
H: 180, D: 470 mm,
□ h=150



▲
C906-CL-03-W
⊕ 3xE27 40W
H: 170, D: 360 mm,
□ h=140

ARITOS

en Metal frame, sandblasted glass diffuser with pattern. **de** Metallrahmen, sandgestrahlter Diffusor aus Glas mit Muster. **fr** Support en métal, diffuseur en verre sablé avec motif. **it** Struttura in metallo, diffusore in vetro sabbiato con decori. **es** Estructura de metal, difusor de vidrio arenado con diseño. **pl** Metalowe obramowanie, dyfuzor szklany piaskowany z wzorem. **ru** Арматура из материала. Плафон из матового стекла с пескоструйным рисунком.



○ White with Gold / WG

● Brown with Gold / R



▲
C900-CL-05-W/R
⊕ 5xE14 40W
H: 200, D: 640 mm,
□ h=175



▲
C900-CL-03-R/W
⊕ 3xE14 40W
H: 160, D: 420 mm,
□ h=135

SPERIA

en Metal frame. Frosted glass diffuser. **de** Metallrahmen. Diffusor aus mattiertem Glas. **fr** Support en métal. Diffuseur en verre dépoli. **it** Struttura in metallo. Diffusore in vetro acidato. **es** Estructura de metal. Difusor de vidrio esmerilado. **pl** Metalowe obramowanie, oszroniony dyfuzor szklany. **ru** Арматура из металла. Плафон из матового стекла.



○ Cream/ BG

● Bronze / BZ



▲
C907-CL-03-R/W
 ⚡ 3xE27 40W
 H: 140, D: 450 mm,
 □ h=105



◀
C907-CL-02-W/R
 ⚡ 2xE14 40W
 H: 110, D: 330 mm,
 □ h=75

DIAMETRIK

en Metal frame, sandblasted glass diffuser with pattern. **de** Metallrahmen, sandgestrahlter Diffusor aus Glas mit Muster. **fr** Support en métal, diffuseur en verre sablé avec motif. **it** Struttura in metallo, diffusore in vetro sabbiato con decori. **es** Estructura de metal, difusor de vidrio arenado con diseño. **pl** Metalowe obramowanie, dyfuzor szklany piaskowany z wzorem. **ru** Арматура из материала. Плафон из матового стекла с пескоструйным рисунком.



○ White with Gold / WG

○ Brown with Gold / BR



▲
 C232-CL-03-R
 ⚡ 3xE27 60W
 H: 280, D: 480 mm

COMBINARE

en Metal frame, matt glass diffuser. **de** Metallrahmen, Diffusor aus mattiertem Glas.
fr Support en métal, diffuseur en verre mat. **it** Struttura in metallo, diffusore in vetro opaco.
es Estructura metálica, difusor de cristal mate. **pl** Metalowe obramowanie, dyfuzor z matowego szkła.
ru Арматура из металла. Плафон из матового стекла.



● Bronze Antique / BZ



◀
C908-CL-04-R/W
 4x E27 40W
 H: 200, D: 470 mm,
 □ h=175



◀
C908-CL-03-W/R
 3x E27 40W
 H: 190, D: 370 mm,
 □ h=165

PASCAL

en Metal frame, sandblasted glass diffuser with pattern. **de** Metallrahmen, sandgestrahlter Diffusor aus Glas mit Muster. **fr** Support en métal, diffuseur en verre sablé avec motif. **it** Struttura in metallo, diffusore in vetro sabbaiato con decori. **es** Estructura de metal, difusor de vidrio arenado con diseño. **pl** Metalowe obramowanie, dyfuzor szklany piaskowany z wzorem. **ru** Арматура из металла. Плафон из матового стекла с пескоструйным рисунком.



● White with Gold / WG

● Bronze Antique / BZ



◀
 H351-TL-01-N
 1xE27 60W
 H: 492, W: 320, L: 210 mm,
 □ d=320 / h=200,
 Class 2

MONTANA

en Metal frame. Decorative element in the form of matt glass flower. PVC lampshade covered with cloth. **de** Standleuchte mit Metallbasis. Eine Blume aus Opakglas als Schmuckelement. PVC-Lampenschirm mit Stoffbezug. **fr** Armature métallique. Éléments décoratifs en forme de fleur en verre dépoli. Abat-jour en PVC recouvert de tissu. **it** Struttura in metallo. Elemento decorativo floreale in vetro opaco. Diffusore in PVC rivestito in tessuto. **es** Estructura de metal. Elemento decorativo de *cristal en forma de flor. Pantalla de PVC revestida de tela. **pl** Metalowe obramowanie. Element dekoracyjny w postaci matowego kwiatu szklanego. Klosz z PCV pokryty tkaniną. **ru** Арматура из металла. Декоративный элемент в виде цветка из матового стекла. Абажур из ПВХ покрыт тканью.



● Nickel / N



◀
Z153-TL-01-BS
💡 1xE27 40W
H: 360, W: 260, L: 180 mm,
□ h=75,
Class 2

KIWI

en Metal frame with antique brass finish. Blown overlay glass diffuser. **de** Metallrahmen mit antiker Messing. Geblasener Overlay-Glasdiffusor. **fr** Support en métal avec finition laiton antique. Diffuseur en verre soufflé laqué. **it** Struttura in metallo con finitura in ottone. Diffusore in vetro soffiato. **es** Estructura de metal con acabado antiguo de latón. Difusor de vidrio soplado superpuesto. **pl** Metalowe obramowanie o wykończeniu antycznego miedzi. Dyfuzor szklany dmuchany. **ru** Арматура из металла. Модель представлена в цвете латунь. Плафон из дутого стекла.



● Brass / BS



PIC118-22-R/W
 2x E14 25W
 H: 122, W: 359, L: 212 mm

RENOIR

en Metal frame, adjustable diffuser. Available in 2 finishes. **de** Metallrahmen, verstellbarer Diffusor. Erhältlich in 2 Ausführungen. **fr** Support en métal, diffuseur réglable. Disponible en 2 finitions. **it** Struttura in metallo, diffusore regolabile. Disponibile in 2 finiture. **es** Estructura metálica, difusor ajustable. Disponible en 2 acabados. **pl** Metalowe obramowanie, regulowany dyfuzor. Dostępny w 2 wykończeniach. **ru** Арматура из металла. Механизм регулировки угла подсветки. Модель представлена в 2-х цветах.



○ White / W ● Bronze / BZ



PIC117-01-R/W
 1x E14 25W
 H: 122, W: 233, L: 212 mm

RUBENS

en Metal frame, adjustable diffuser. Available in 2 finishes. **de** Metallrahmen, verstellbarer Diffusor. Erhältlich in 2 Ausführungen. **fr** Support en métal, diffuseur réglable. Disponible en 2 finitions. **it** Struttura in metallo, diffusore regolabile. Disponibile in 2 finiture. **es** Estructura metálica, difusor ajustable. Disponible en 2 acabados. **pl** Metalowe obramowanie, regulowany dyfuzor. Dostępny w 3 wykończeniach. **ru** Арматура из металла. Механизм регулировки угла подсветки. Модель представлена в 2-х цветах.



○ White / W ● Bronze / BZ



PIC114-02-G/R/W

☞ 2xE14 25W

H: 171, W: 445, L: 209 mm

PICASSO

en Metal frame, adjustable diffuser. Available in 3 finishes. **de** Metallrahmen, verstellbarer Diffusor. Erhältlich in 3 Ausführungen. **fr** Support en métal, diffuseur réglable. Disponible en 3 finitions. **it** Struttura in metallo, diffusore regolabile. Disponibile in 3 finiture. **es** Estructura metálica, difusor ajustable. Disponible en 3 acabados. **pl** Metalowe obramowanie, regulowany dyfuzor. Dostępny w 3 wykończeniach. **ru** Арматура из металла. Механизм регулировки угла подсветки. Модель представлена в 3-х цветах.



○ White / W

● Bronze / BZ

● Gold / G



PIC113-02-R/G/W

☞ 2xE14 25W

H: 180, W: 440, L: 165 mm

RAPHAEL

en Metal frame, adjustable diffuser. Available in 3 finishes. **de** Metallrahmen, verstellbarer Diffusor. Erhältlich in 3 Ausführungen. **fr** Support en métal, diffuseur réglable. Disponible en 3 finitions. **it** Struttura in metallo, diffusore regolabile. Disponibile in 3 finiture. **es** Estructura metálica, difusor ajustable. Disponible en 3 acabados. **pl** Metalowe obramowanie, regulowany dyfuzor. Dostępny w 3 wykończeniach. **ru** Арматура из металла. Механизм регулировки угла подсветки. Модель представлена в 3-х цветах.



○ White / W

● Bronze / BZ

● Gold / G



PIC119-44-W

☞ 4xE14 25W

H: 122, W: 713, L: 200 mm



PIC119-44-R

☞ 4xE14 25W

H: 122, W: 713, L: 200 mm

GOVANNI

en Metal frame, adjustable diffuser. Available in 2 finishes. **de** Metallrahmen, verstellbarer Diffusor. Erhältlich in 2 Ausführungen. **fr** Support en métal, diffuseur réglable. Disponible en 2 finitions. **it** Struttura in metallo, diffusore regolabile. Disponibile in 2 finiture. **es** Estructura metálica, difusor ajustable. Disponible en 2 acabados. **pl** Metalowe obramowanie, regulowany dyfuzor. Dostępny w 2 wykończeniach. **ru** Арматура из металла. Механизм регулировки угла подсветки. Модель представлена в 2-х цветах.



○ White / W

● Bronze / BZ



▲
DL278-1-01-W
☞ 1xGU10 35W
H: 118, D: 140 mm,
Class 2, Paintable



▲
DL279-1-01-W
☞ 1xGU10 35W
H: 98, D: 102 mm,
Class 2, Paintable



▲
DL284-1-01-W
☞ 1xGU10 35W
H: 100, D: 127 mm,
Class 2, Paintable

GYPS CLASSIC

en Recessed light, white plaster body. Paintable. **de** Einbauleuchte, weißer Korpus aus Gips. Bemalbar. **fr** Spot intégré, corps en plâtre blanc, peignable. **it** Faretto da incasso, corpo in gesso bianco. Verniciabile. **es** Luz empotrada de yeso blanco. Pintable. **pl** Wbudowany reflektor, obudowa o wyglądzie białego tynku. Możliwość malowania. **ru** Встраиваемый спот. Корпус из белого гипса. Возможность окрашивания.



○ White / W



▲
DL301-2-01-CH/G
☞ 1xGU10 50W
H: 74, D: 95 mm,
Class 2



▲
DL300-2-01-CH
☞ 1xGU10 50W
H: 74, D: 110 mm,
Class 2



▲
DL302-2-01-G
☞ 1xGU10 50W
H: 74, D: 95 mm,
Class 2

METAL CLASSIC

en Recessed spotlight. Metal frame. **de** Einbaustrahler mit Metallrahmen. **fr** Spot encastré. Armature métallique. **it** Faretto da incasso. Struttura in metallo. **es** Foco empotrable. Estructura de metal. **pl** Wgłębione światło punktowe. Metalowe obramowanie. **ru** Встраиваемый спот. Корпус из металла.



● Gold / G

● Chrome / CH



Loft
Universal base

MAYTONI LOFT



▲
T546PL-12B
 ⚡ 12xE27 7W
 H min: 557, H max: 1562,
 D: 750 mm

JACKSON

en Metal frame, black finish. Gold socket cover. **de** Metallrahmen, schwarz lackiert. Goldene Lampensockel.
fr Armature métallique, finition noire, culots couleur dorée. **it** Struttura in metallo con finitura nera.
 Portalampade dorati. **es** Estructura metálica, acabado en negro. Portalámparas dorado. **pl** Metalowe
 obramowanie, wykończenie w kolorze czarnym. Złote złącza. **ru** Арматура из металла окрашена в черный цвет.
 Цоколи золотого цвета.



● Black / B



▲
T546PL-18B
⦿ 18xE27 7W
H min: 742, H max: 1669,
D: 980 mm



▲
T532CL-12B
 ⚡ 12xE27 60W
 H: 252, W: 1230, L: 880 mm



◀
T532CL-08B
 ⚡ 8xE27 60W
 H: 252, W: 870, L: 590 mm

GILBERT

en Metal frame, black finish. **de** Metallrahmen, schwarz lackiert. **fr** Armature métallique, finition noire. **it** Struttura in metallo con finitura nera. **es** Estructura metálica, acabado en negro. **pl** Metalowe obramowanie, wykończenie w kolorze czarnym. **ru** Арматура из металла окрашена в черный цвет.



● Black / B



▲
T532WL-02B
 ⚡ 2xE27 60W
 H: 305, W: 250, L: 170 mm



▲
T021-03-B
 ☞ 3x E27 60W
 H min: 470, H max: 1350,
 W: 550, L: 200 mm

▲
T021-01-B
 ☞ 1x E27 60W
 H min: 480, H max: 1170,
 D: 200 mm,
 □ h=410

SPIDER

en Metal frame with decorative metal rods diffusers. **de** Metallrahmen mit Diffusoren aus dekorativen Metallstäben. **fr** Armature et tiges décoratives en métal. Hauteur ajustable. **it** Struttura in metallo con diffusori a barre decorative in metallo. **es** Estructura metálica con difusores decorativos de varillas metálicas. **pl** Metalowa rama z dekoracyjnymi dyfuzorami metalowymi. **ru** Арматура из металла. Декоративный плафон из металлических прутьев.



● Black / B



▲
T354-PL-04-B
 ⚡ 4xE27 60W
 H min: 380, H max: 1556,
 W: 915, L: 170 mm,
 □ h=220

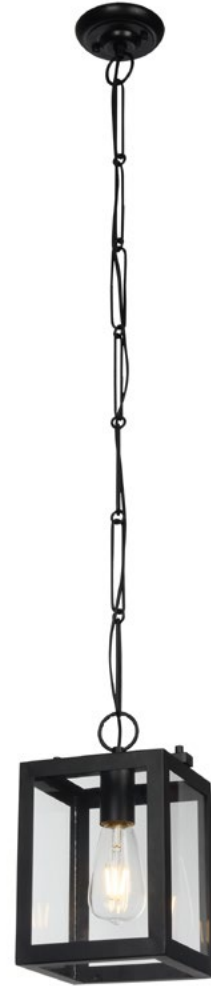

▲
T354-PL-01-B
 ⚡ 1xE27 60W
 H min: 355, H max: 1222,
 D: 171 mm,
 □ h=220



▲
T354-WL-01-B
 ⚡ 1xE27 60W
 H: 220, W: 190, L: 170 mm,
 □ h=220

DELPHI

en Metal body, matt black finish. Clear glass slabs diffuser. **de** Korpus aus Metall, mattschwarz lackiert. Diffusor aus klaren Glasscheiben. **fr** Corps en métal, finition noir mat. Diffuseur verre transparent. **it** Corpo in metallo, finitura nero opaco. Diffusore in lastre di vetro trasparente. **es** Estructura de metal, acabado negro mate. Difusores rectangulares de cristal transparente. **pl** Obudowa metalowa, wykończona na czarno matowo. Dyfuzor z przezroczystego szkła. **ru** Корпус из металла окрашен в черный цвет. Плафон из прозрачного стекла.



● Black / B





T432-PL-01-G

1xE14 60W

H min: 240, H max: 1730,

D: 210 mm,

□ h=175

SOPRANO

en Metal cup and decorative rods. Adjustable. **de** Deckenbaldachin aus Metall und dekorative Stäbe. Höhenverstellbar. **fr** Coupelle et tiges décoratives en métal. Hauteur ajustable. **it** Calotta in metallo e barre decorative. Altezza regolabile. **es** Florón de metal y varillas decorativas. Altura ajustable. **pl** Metalowy szkielet i ozdobne pręty. Regulowana wysokość. **ru** Потолочная чаша из металла. Плафон из металлических прутьев. Регулируемая длина.



● Gold Matt / G



T432-PL-03-G

☞ 3x E14 60W

H min: 270, H max: 1760,

W: 800, L: 210 mm,

□ h=175



▲
T062-PL-16-B/W
 ⚡ 1xE14 60W
 H min: 320, H max: 2320,
 D: 165 mm,
 □ d1=50 / d2=165 / h=260



▲
T062-PL-23-W/B
 ⚡ 1xE14 60W
 H min: 505, H max: 2500,
 D: 225 mm,
 □ d1=60 / d2=225 / h=445

GINGER AND FRED

en Metal frame and diffuser. **de** Metallrahmen und Diffusor. **fr** Armature et diffuseur en métal. **it** Struttura e diffusore in metallo. **es** Estructura y difusor metálicos. **pl** Metalowe obramowanie i dyfuzor. **ru** Арматура и плафон выполнены из металла.



○ White / W

● Black / B

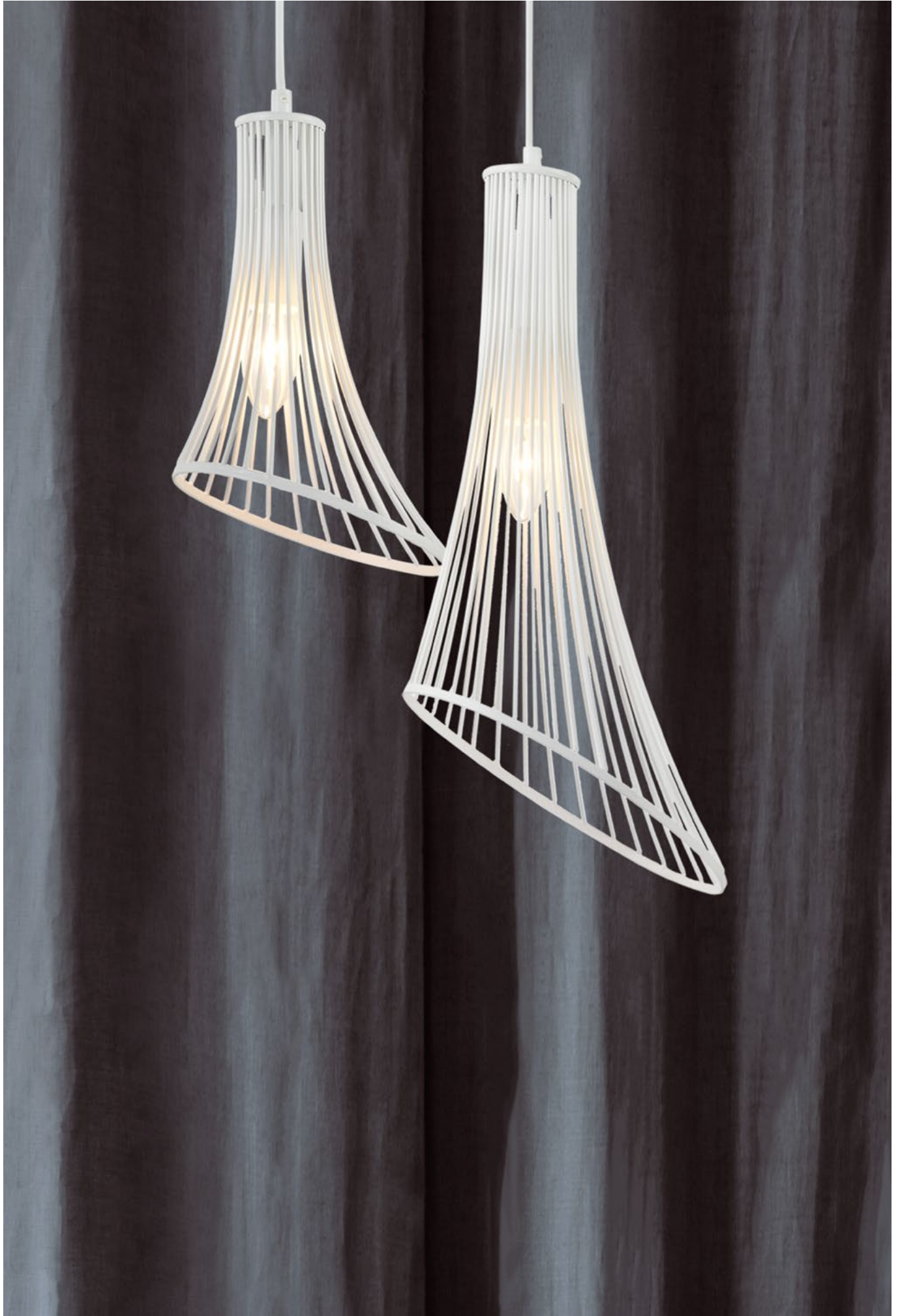



◀
T442-PL-01-B
 ⚡ 1xE27 60W
 H min: 275, H max: 2270,
 D: 180 mm,
 □ d=180 / h=150



◀
T443-PL-01-B
 ⚡ 1xE27 60W
 H min: 265, H max: 2260,
 D: 180 mm,
 □ d=180

MONZA

en Black metal cup and decorative diffuser. Adjustable height. **de** Schwarzer Deckenbaldachin aus Metall und dekorative Diffusor. Höhenverstellbar. **fr** Coupelle en métal noir et diffuseur décoratif. Hauteur réglable. **it** Calotta nera in metallo e diffusore decorativo. Altezza regolabile. **es** Florón metálico negro y difusor decorativo. Altura ajustable. **pl** Czarna metalowa puszcza sufitowa i ozdobny dyfuzor. Regulowana wysokość. **ru** Потолочная чаша выполнена из металла, окрашена в черный цвет. Декоративный плафон из металла. Регулируемая длина.



● Black / B



◀
T018-01-B
 ⚡ 1xE27 60W
 H min: 350, H max: 1040,
 D: 230 mm,
 □ d1=30 / d2=150 / h=280



▲
T018-03-B
 ⚡ 3xE27 60W
 H min: 350, H max: 1240,
 D: 300 mm,
 □ d1=30 / d2=150 / h=280

GRILLE

en Metal frame with decorative metal mesh diffusers. **de** Metallrahmen mit dekorativen Diffusoren aus Metallgitter. **fr** Armature métallique avec diffuseur en grillage métallique. **it** Struttura in metallo con diffusori decorativi a griglia metallica. **es** Estructura metálica con difusores decorativos de metal. **pl** Metalowe obramowanie z dekoracyjnymi dyfuzorami metalowymi. **ru** Арматура из металла. Плафоны выполнены из декоративной металлической сетки.



● Black / B



▲
T164-11-G
 ⚡ 1xE27 40W
 H min: 230, H max: 1500,
 D: 125 mm,
 □ d=125 / h=122

▲
T164-11-N
 ⚡ 1xE27 40W
 H min: 230, H max: 1500,
 D: 125 mm,
 □ d=125 / h=122



◀
T164-01-G
 ⚡ 1xE27 40W
 H: 235, W: 125, L: 215 mm,
 □ d=125 / h=122



◀
T164-01-N
 ⚡ 1xE27 40W
 H: 235, W: 125, L: 215 mm,
 □ d=125 / h=122

TEMPO

en Metal frame, glass diffuser with embossed decor. Adjustable. **de** Metallrahmen, Diffusor aus Glas mit eingepprägtem Dekor. Höhenverstellbar. **fr** Support en métal, diffuseur en verre avec décor incorporé. Hauteur ajustable. **it** Struttura in metallo, diffusore in vetro con decorazione incorporata. Altezza regolabile. **es** Estructura de metal, difusor de cristal con decoración incorporada. Altura ajustable. **pl** Metalowe obramowanie, szklany dyfuzor z wbudowanym elementem dekoracyjnym. Regulowana wysokość. **ru** Арматура из металла. Плафон из рельефного стекла. Регулируемая высота.



● Black / B



◀
T268-PL-01-W
 1xE27 60W
 H min: 300, H max: 1330,
 D: 185 mm,
 □ d1=70 / d2=185 / h=100

ARGO

en Metal frame in two colours. Clear glass lampshade. **de** Moderne Pendelleuchte in zwei Farben. Lampenschirm aus Klarglas. **fr** Armature métallique disponible en deux couleurs. Abat-jour en verre transparent. **it** Struttura in metallo disponibile in due colori. Diffusore in vetro trasparente. **es** Estructura de metal disponible en dos colores. Pantalla de vidrio transparente. **pl** Metalowe obramowanie w dwóch kolorach. Przezroczysty klosz szklany. **ru** Каркас из металла 2-х цветов. Плафон из прозрачного стекла.



○ White / W

● Brass / BS



▲
T268-PL-01-BS
 1xE27 60W
 H min: 300, H max: 1330,
 D: 185 mm,
 □ d1=70 / d2=185 / h=100



▲
T192-PL-01-B
☉ 1xE27 40W
H min: 530, H max: 1930,
D: 120 mm,
□ d=70 / h=200



▲
T187-PL-01-B
☉ 1xE27 40W
H min: 510, H max: 1850,
D: 180 mm,
□ d1=70 / d2=180 / h=170



▲
T193-PL-01-B
☉ 1xE27 40W
H min: 440, H max: 1840,
D: 130 mm,
□ d=110 / h=250



▲
T194-PL-01-B
☉ 1xE27 40W
H min: 430, H max: 1830,
D: 320 mm,
□ d=145 / h=230



▲
T195-PL-01-B
☉ 1xE27 40W
H min: 450, H max: 1850,
D: 120 mm,
□ d=90 / h=150

CITY

en Frame made from metal rods in the form of world architectural works. Lampshade of white cotton. **de** Pendelleuchte mit einem Metallgestell in Form von berühmter Architektur. Lampenschirm aus weißer Baumwolle. **fr** Armature en fils métalliques en forme d'œuvres architecturales mondiales. Abat-jour en coton blanc. **it** Struttura in metallo, che ricorda famose opere architettoniche. Diffusore in cotone bianco. **es** Estructura formada por varillas de metal que emulan obras arquitectónicas de todo el mundo. Pantalla de algodón blanco. **pl** Obramowanie z metalowych prętów w kształcie światowych dzieł architektonicznych. Klosz z białej bawełny. **ru** Каркас из металлических прутьев в виде мировых произведений архитектуры. Плафон из белого хлопка.



● Black / B



DENVER

en Black metal cup and decorative diffuser. Adjustable. **de** Schwarzer Deckenbaldachin aus Metall und dekorative Diffusor. Höhenverstellbar. **fr** Coupelle en métal noir et diffuseur décoratif. Hauteur réglable. **it** Calotta nera in metallo e diffusore decorativo. Altezza regolabile. **es** Florón metálico negro y difusor decorativo. Altura ajustable. **pl** Czarna metalowa puszka sufitowa i ozdobny dyfuzor. Regulowana wysokość. **ru** Потолочная чаша выполнена из металла, окрашена в черный цвет. Декоративный плафон из металла. Регулируемая длина.



● Black / B



T450-PL-01-B

☞ 1xE27 60W

H min: 310, H max: 2300,

D: 165 mm,

☐ d1=66 / d2=165 / h=180



▲
T436-PL-01-GR
☞ 1xE27 60W
H min: 300, H max: 2290,
D: 160 mm,
□ d1=55 / d2=130 / h=190

▲
T452-PL-01-GR
☞ 1xE27 60W
H min: 290, H max: 2280,
D: 230 mm,
□ d1=55 / d2=160 / h=180

GOSFORD

en Concrete diffuser with metal decorative element in different shapes. Adjustable height. **de** Diffusor aus Beton mit Metalldekor in verschiedenen Formen. Höhenverstellbar. **fr** Armature en métal avec douille en béton. Abat-jour décoratif avec grillage métallique. **it** Diffusore in calcestruzzo con elemento decorativo in metallo in diverse forme. Altezza regolabile. **es** Difusor de cemento con elemento decorativo de metal en diferentes formas. Altura ajustable. **pl** Dyfuzor o wyglądzie betonu z metalowym elementem dekoracyjnym o różnych kształtach. Regulowana wysokość. **ru** Каркас из металла, патрон выполнен с использованием бетона. Декоративный плафон из металлической сетки. Регулируемая длина.



● Black / B



BRONI

en Metal ceiling cup. Concrete diffuser of different shapes and sizes. Adjustable. **de** Deckenbaldachin aus Metall. Diffusor aus Beton in verschiedenen Formen und Größe. Höhenverstellbar. **tr** Coupelle en métal. Diffuseur en béton de différentes formes et tailles. Hauteur réglable. **it** Calotta da soffitto in metallo. Diffusore in calcestruzzo di diverse forme e dimensioni. Altezza regolabile. **es** Florón metálico. Difusor de cemento con elemento decorativo de metal en diferentes formas. Altura ajustable. **pl** Metalowa puszką sufitowa. Dyfuzor o wyglądzie betonu o różnych kształtach i rozmiarach. Regulowana wysokość. **ru** Потолочная чаша из металла. Плафоны из бетона. Различные формы плафонов. Регулируемая длина.



● Black / B

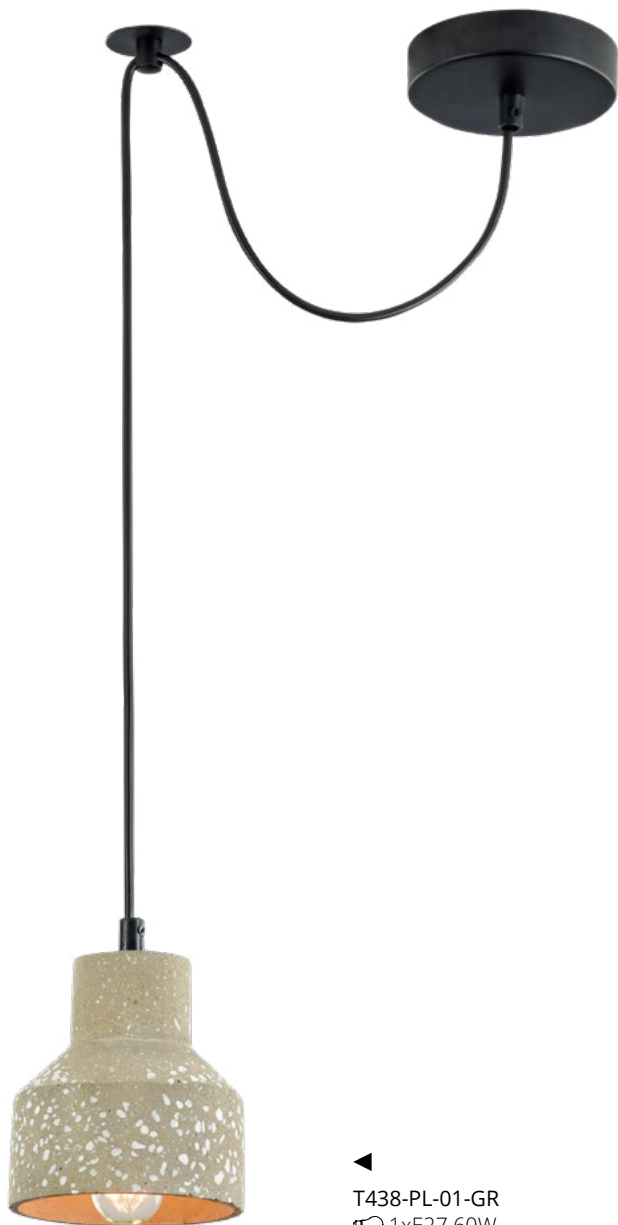

▲
T438-PL-01-GR
 ⚡ 1xE27 60W
 H min: 200, H max: 2220,
 D: 125 mm,
 □ d=125 / h=135



▲
T451-PL-01-GR
 ⚡ 1xE27 60W
 H min: 240, H max: 2230,
 D: 200 mm,
 □ d=200 / h=180



▲
T440-PL-01-GR
 ⚡ 1xE27 60W
 H min: 230, H max: 2220,
 D: 190 mm,
 □ d1=150 / d2=190 / h=170



▲
T433-PL-01-GR
 ⚡ 1xE27 60W
 H min: 220, H max: 2210,
 D: 165 mm,
 □ d1=55 / d2=165 / h=150



▲
T434-PL-01-GR
 ⚡ 1xE27 60W
 H min: 230, H max: 2220,
 D: 160 mm,
 □ d1=65 / d2=160 / h=160



▲
T437-PL-01-GR
 ⚡ 1xE27 60W
 H min: 200, H max: 2220,
 D: 125 mm,
 □ d1=55 / d2=125 / h=135



▲
T439-PL-01-GR
 ⚡ 1xE27 60W
 H min: 290, H max: 2220,
 D: 160 mm,
 □ d=160 / h=225



▲
T455-10-BASE
H: 30, D: 205 mm



▲
T455-08-BASE
H: 30, D: 205 mm



▲
T455-05-BASE
H: 30, D: 205 mm



▲
T455-14-BASE
H: 30, D: 205 mm

▲
T455-05-BASE + SERIES
GINGER AND FRED

DAKOTA

en Ceiling base for mounting of bulbs for 5, 8, 10 and 14 pendants. **de** Deckenhalterung für verschiedene Anzahl an Gehängen. **fr** Base de plafond pour le montage d'ampoules sur un nombre different de suspensions. **it** Base per il montaggio a soffitto di lampadine pendenti (5, 8, 10 e 14 luci). **es** Plafón para bombillas de 5, 8, 10 y 14 colgantes. **pl** Podstawa sufitowa do montażu żarówek na 5, 8, 10 i 14 zawieszek. **ru** Потолочное основание для крепления лампочек на 5, 8, 10 и 14 подвесов.



● Black / B



▲
SPR-BASE-R-03-B +
SERIES EUSTOMA



▲
SPR-BASE-03-B/W
H: 25, W: 650, L: 50 mm



▲
SPR-BASE-R-03-B/W
H: 25, D: 300 mm



▲
SPR-BASE-R-02-W/B
H: 20, D: 80 mm

UNIVERSAL BASE

en Metal ceiling bases with single or multiple light plank. **de** Lampenbaldachin aus Metall mit einer oder mehreren Leuchten. **fr** Base de fixation simple ou multiple. **it** Basi metalliche da soffitto per luce singola o multipla. **es** Florón de metal con punton de luz simple o múltiple. **pl** Metalowe podstawy sufitowe z jedną lub kilkoma zawieszkami. **ru** Потолочное основание для крепления одного или нескольких подвесов. Модель выполнена из металла.



○ White / W

● Black / B



Outdoor

MAYTONI OUTDOOR



▲
O594WL-L6GR
LED 6W
H: 160, W: 100, L: 78 mm,
380 Lumen, 3000 K, IP65



◀
O594WL-L6W
LED 6W
H: 160, W: 95, L: 165 mm,
380 Lumen, 3000 K, IP54

TIMES SQUARE

en Metal body. Resistant to thermal shock and corrosion. Integrated LED module. **de** Korpus aus Metall. Beständig gegen Temperaturwechsel und Korrosion. Integriertes LED Modul. **fr** Corps en métal. Résistant aux chocs thermiques et à la corrosion. Module LED intégré. **it** Corpo in metallo. Resistente alle variazioni di temperatura e alla corrosione. Modulo LED integrato. **es** Estructura metálica resistente al choque térmico y a la corrosión. Módulo LED integrado. **pl** Metalowy korpus odporny na szok termiczny i korozję. Zintegrowany moduł LED. **ru** Устойчивый к перепадам температуры и коррозии корпус из металла. Встроенный LED-модуль.



○ White / W

● Black / B

● Grey / GR



▲
O580WL-L6W
 LED 6W
 H: 200, W: 90, L: 90 mm,
 100 Lumen, 3200 K, IP54



▲
O581WL-L6W
 LED 6W
 H: 160, W: 90, L: 55 mm,
 480 Lumen, 3000 K, IP54



▲
O581WL-L6B
 LED 6W
 H: 160, W: 90, L: 55 mm,
 480 Lumen, 3000 K, IP54



▲
O580WL-L6B
 LED 6W
 H: 200, W: 90, L: 90 mm,
 100 Lumen, 3200 K, IP54



▲
O573WL-L6GR
LED 6W
H: 95, W: 135, L: 115 mm,
500 Lumen, 3000 K, IP54



▲
O573WL-L6B
LED 6W
H: 95, W: 135, L: 115 mm,
500 Lumen, 3000 K, IP54



▲
O572WL-L6GR
LED 6W
H: 100, W: 100, L: 100 mm,
500 Lumen, 3000 K, IP54



▲
O572WL-L6W
LED 6W
H: 100, W: 100, L: 100 mm,
500 Lumen, 3000 K, IP54

FULTON

en Metal body. Resistant to thermal shock and corrosion. Integrated LED module. Adjustable light beam. **de** Korpus aus Metall. Beständig gegen Temperaturwechsel und Korrosion. Integriertes LED Modul. Einstellbarer Lichtstrahl. **fr** Corps en métal. Résistant aux chocs thermiques et à la corrosion. Module LED intégré. Faisceau de lumière réglable. **it** Corpo in metallo. Resistente alle variazioni di temperatura e alla corrosione. Modulo LED integrato. Fascio di luce regolabile. **es** Estructura metálica resistente al choque térmico y a la corrosión. Módulo LED integrado. Haz de luz ajustable. **pl** Metalowy korpus odporny na szok termiczny i korozję. Zintegrowany moduł LED. Możliwość regulacji wiązki światła. **ru** Устойчивый к перепадам температуры и коррозии корпус из металла. Встроенный LED-модуль. Регулировка направления светового потока.



○ White / W

● Black / B

● Grey / GR



▲
O573WL-L6W
LED 6W
H: 95, W: 135, L: 115 mm,
500 Lumen, 3000 K, IP54



▲
O572WL-L6B
LED 6W
H: 100, W: 100, L: 100 mm,
500 Lumen, 3000 K, IP54



◀
O011WL-L6B
 LED 6W
 H: 100, D: 108 mm,
 400 Lumen, 3000 K, IP54



◀
O011FL-L6B
 LED 6W
 H: 500, D: 108 mm,
 370 Lumen, 3000 K, IP54

WOLSELEY ROAD

en Metal bode. Resistant to thermal shock and corrosion. LED module. **de** Temperatur- und korrosionsbeständiger Metallrahmen. Modul LED. **fr** Cadre métallique résistant à la température et à la corrosion. Module LED. **it** Struttura in metallo resistente alle variazioni di temperatura e alla corrosione. Modulo LED. **es** Estructura de metal resistente de la temperatura diferente y de la corrosión. **pl** Metalowa obudowa odporna na wahania temperatur i korozję. Moduł LED. **ru** Устойчивый к перепадам температуры и коррозии корпус из металла. LED-модуль.



● Black / B



O584WL-L10B
LED 10W
H: 150, W: 150, L: 50 mm,
LED SMD EPISTAR 5730,
480 Lumen, 3000 K, IP54



O583WL-L10B
LED 10W
H: 150, W: 150, L: 50 mm,
LED SMD EPISTAR 5730,
1000 Lumen, 3000 K, IP54

MADISON AVENUE

en Outdoor wall lamp. Metal frame resistant to temperature deviations and corrosion. **de** Außenleuchte mit temperatur- und korrosionsbeständigem Metallrahmen. **fr** Lampe murale d'extérieur. Armature métallique résistante aux variations de la température et à la corrosion. **it** Applique per esterni. Struttura metallica resistente alle variazioni di temperatura e alla corrosione. **es** Aplique de pared para exteriores. Estructura de metal resistente a los cambios de temperatura y la corrosión. **pl** Zewnętrzny kinkiet ścienny. Metalowa obudowa odporna na wahania temperatur i korozję. **ru** Настенный уличный светильник. Устойчивый к перепадам температуры и коррозии корпус из металла.



● Black / B



O575WL-L6W
 LED 6W
 H: 100, W: 110, L: 50 mm,
 460 Lumen, 3000 K, IP54



O575WL-L6B
 LED 6W
 H: 100, W: 110, L: 50 mm,
 460 Lumen, 3000 K, IP54

GANSEVOORT

en Metal body. Resistant to thermal shock and corrosion. Integrated LED module. **de** Korpus aus Metall. Beständig gegen Temperaturwechsel und Korrosion. Integriertes LED Modul. **fr** Corps en métal. Résistant aux chocs thermiques et à la corrosion. Module LED intégré. **it** Corpo in metallo. Resistente alle variazioni di temperatura e alla corrosione. Modulo LED integrato. **es** Estructura metálica resistente al choque térmico y a la corrosión. Módulo LED integrado. **pl** Metalowy korpus odporny na szok termiczny i korozję. Zintegrowany moduł LED. **ru** Устойчивый к перепадам температуры и коррозии корпус из металла. Встроенный LED-модуль.



○ White / W

● Black / B

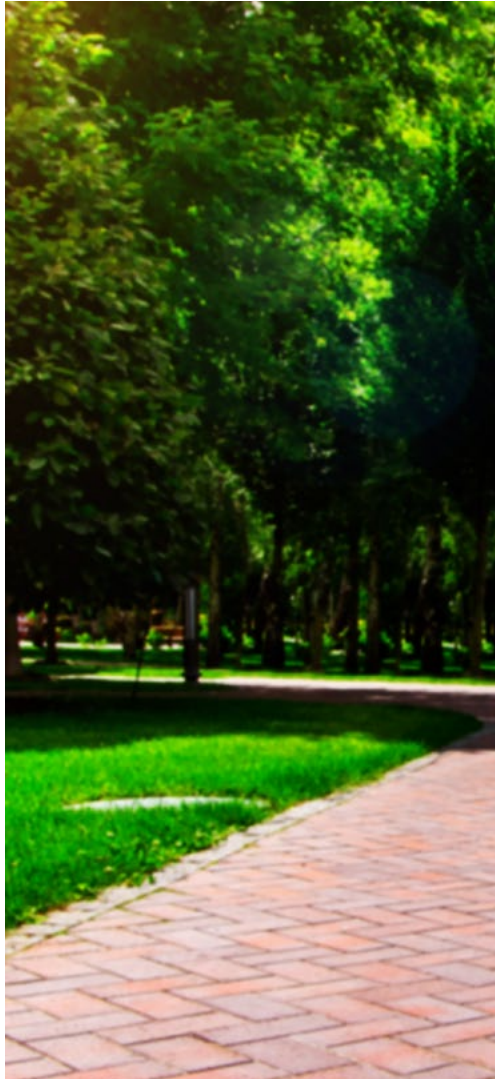

▲
O803WL-L6W
LED 6W
H: 50, W: 115, L: 100 mm,
LED SMD EPISTAR 2835,
500 Lumen, 3000 K, IP54



◀
O803WL-L6B
LED 6W
H: 50, W: 115, L: 100 mm,
LED SMD EPISTAR 2835,
500 Lumen, 3000 K, IP54

BROADWAY

en Outdoor wall lamp. Metal frame. Glass diffuser. **de** Außen-Wandleuchte mit robustem Metallrahmen und Glasschirm. **fr** Lampe murale d'extérieur. Armature métallique. Diffuseur de lumière en verre. **it** Applique per esterni. Struttura in metallo. Diffusore in vetro. **es** Aplique de pared para exteriores. Estructura de metal. Difusor de vidrio. **pl** Zewnętrzny kinkiet ścienny. Metalowa obudowa. Szklany dyfuzor. **ru** Настенный уличный светильник. Корпус из металла. Стекланный рассеиватель.



3000K

○ White / W

● Black / B



◀
O802WL-L7B
 LED 8W
 H: 170, W: 170, L: 75 mm,
 640 Lumen, 3000 K, IP54

◀
O577WL-L5B
 LED 5W
 H: 70, W: 120, L: 120 mm,
 450 Lumen, 3000 K, IP54

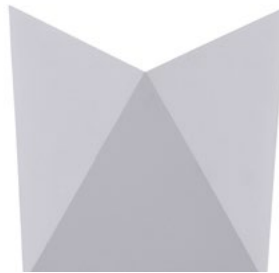

◀
O802WL-L7W
 LED 8W
 H: 170, W: 170, L: 75 mm,
 640 Lumen, 3000 K, IP54

BEEKMAN

en Metal body. Resistant to thermal shock and corrosion. Integrated LED module. **de** Korpus aus Metall. Beständig gegen Temperaturwechsel und Korrosion. Integriertes LED Modul. **fr** Corps en métal. Résistant aux chocs thermiques et à la corrosion. Module LED intégré. **it** Corpo in metallo. Resistente alle variazioni di temperatura e alla corrosione. Modulo LED integrato. **es** Estructura metálica resistente al choque térmico y a la corrosión. Módulo LED integrado. **pl** Metalowy korpus odporny na szok termiczny i korozję. Zintegrowany moduł LED. **ru** Устойчивый к перепадам температуры и коррозии корпус из металла. Встроенный LED-модуль.



○ White / W

● Black / B



◀
O574WL-01B
 ⚡ 1xGU10 50W
 H: 134, W: 64, L: 115 mm,
 IP54



◀
O574WL-02B
 ⚡ 2xGU10 50W
 H: 180, W: 64, L: 115 mm,
 IP54

BOWERY

en Metal body. Resistant to thermal shock and corrosion. LED bulbs recommended. **de** Korpus aus Metall. Beständig gegen Temperaturwechsel und Korrosion. LED Lampen empfohlen. **fr** Corps en métal. Résistant aux chocs thermiques et à la corrosion. Ampoules LED recommandées. **it** Corpo in metallo. Resistente alle variazioni di temperatura e alla corrosione. Si consiglia di utilizzare lampadine a LED. **es** Estructura metálica resistente al choque térmico y a la corrosión. Se recomiendan bombillas LED. **pl** Metalowy korpus odporny na szok termiczny i korozję. Zaleca się używanie żarówek LED. **ru** Устойчивый к перепадам температуры и коррозии корпус из металла. Рекомендуется использовать светодиодные лампы.



● Black / B



▲
O576WL-01B
 ⚡ 1xE27 60W
 H: 200, W: 100, L: 163 mm,
 IP54



▲
O576WL-02B
 ⚡ 2xE27 60W
 H: 320, W: 108, L: 175 mm,
 IP54



◀
O576FL-01B
 ⚡ 1xE27 60W
 H: 796, D: 155 mm,
 IP54

BRONX

en Metal body. Resistant to thermal shock and corrosion. Glass diffuser. LED bulbs recommended. **de** Korpus aus Metall. Beständig gegen Temperaturwechsel und Korrosion. Diffusor aus Glas. LED Lampen empfohlen. **fr** Corps en métal. Résistant aux chocs thermiques et à la corrosion. Diffuseur en verre. Ampoules LED recommandées. **it** Corpo in metallo. Resistente alle variazioni di temperatura e alla corrosione. Diffusore in vetro. Si consiglia di utilizzare lampadine a LED. **es** Estructura metálica resistente al choque térmico y a la corrosión. Se recomiendan bombillas LED. **pl** Metalowy korpus odporny na szok termiczny i korozję. Dyfuzor ze szkła. Zaleca się używanie żarówek LED. **ru** Устойчивый к перепадам температуры и коррозии корпус из металла. Плафон из стекла. Рекомендуется использовать светодиодные лампы.



● Black / B



▲
O010WL-02B
 ⚡ 2xGU10 50W
 H: 67, W: 205, L: 65 mm,
 □ d=65 / h=67,
 IP54



▲
O010WL-01B
 ⚡ 1xGU10 50W
 H: 67, W: 135, L: 65 mm,
 □ d=65 / h=67,
 IP54



◀
O010FL-02B
 ⚡ 2xGU10 50W
 H: 550, W: 205, L: 65 mm,
 IP54



◀
O010FL-01B
 ⚡ 1xGU10 50W
 H: 550, W: 135, L: 65 mm,
 IP54

WALL STREET

en Temperature- and corrosion-resistant metal frame. Adjustment of light flow direction. LED bulbs are recommended.

de Temperatur- und korrosionsbeständiger Metallrahmen. Einstellung der Lichtstromrichtung. LED-Birnen werden empfohlen.

fr Cadre métallique résistant à la température et à la corrosion. Réglage de la direction du flux lumineux. Les ampoules LED sont recommandées.

it Struttura in metallo resistente alle variazioni di temperatura e alla corrosione. Regolazione della direzione del flusso luminoso. Si consiglia l'uso di lampadine a LED.

es Estructura de metal resistente de la temperatura diferente y de la corrosión. La dirección de luz ajustado. Bombillas LED son recomendadas.

pl Metalowa obudowa odporna na wahania temperatur i korozję. Możliwość regulacji kierunku przepływu światła. Zaleca się używanie żarówek LED.

ru Устойчивый к перепадам температуры и коррозии корпус из металла. Регулировка направления светового потока. Рекомендуем использовать светодиодные лампы.



● Black / B





▲
O578WL-01B
 1xE27 60W
 H: 207, W: 110, L: 100 mm,
 IP54



▲
O578WL-02B
 2xE27 60W
 H: 330, W: 110, L: 100 mm,
 IP54



▲
O578FL-01B
 1xE27 60W
 H: 610, W: 140, L: 140 mm,
 IP54

UNTER DEN LINDEN

en Metal body. Resistant to thermal shock and corrosion. Glass diffuser. LED bulbs recommended. **de** Korpus aus Metall. Beständig gegen Temperaturwechsel und Korrosion. Diffusor aus Glas. LED Lampen empfohlen. **fr** Corps en métal. Résistant aux chocs thermiques et à la corrosion. Diffuseur en verre. Ampoules LED recommandées. **it** Corpo in metallo. Resistente alle variazioni di temperatura e alla corrosione. Diffusore in vetro. Si consiglia di utilizzare lampadine a LED. **es** Estructura metálica resistente al choque térmico y a la corrosión. Se recomiendan bombillas LED. **pl** Metalowy korpus odporny na szok termiczny i korozję. Dyfuzor ze szkła. Zaleca się używanie żarówek LED. **ru** Устойчивый к перепадам температуры и коррозии корпус из металла. Плафон из стекла. Рекомендуется использовать светодиодные лампы.



● Black / B





LA RAMBLA

en Metal body. Resistant to thermal shock and corrosion. Textured clear glass diffuser. **de** Korpus aus Metall. Beständig gegen Temperaturwechsel und Korrosion. Diffusor aus strukturiertem Klarglas. **fr** Corps en métal. Résistant aux chocs thermiques et à la corrosion. Diffuseur en verre clair texturé. **it** Corpo in metallo. Resistente alle variazioni di temperatura e alla corrosione. Diffusore in vetro trasparente testurizzato. **es** Estructura metálica resistente al choque térmico y a la corrosión. Difusor de cristal transparente con textura. **pl** Metalowy korpus odporny na szok termiczny i korozję. Przezroczysty klosz z teksturowanego szkła. **ru** Корпус из металла, устойчивый к перепадам температуры. Плафон из фактурного прозрачного стекла.



 Brown / BR



◀
S104-119-51-R
☉ 1xE27 100W
H: 1199, D: 240 mm,
□ d1=240 / d2=80 / h=448,
IP44



▲
S104-10-41-R
☉ 1xE27 60W
H min: 642, H max: 1479,
D: 240 mm,
□ d1=240 / d2=80 / h=448,
IP44



▲
S104-59-31-R
☉ 1xE27 60W
H: 593, D: 240 mm,
IP44



CHAMPS ELYSEES

en Metal body. Resistant to thermal shock and corrosion. Tinted glass diffuser. **de** Korpus aus Metall. Beständig gegen Temperaturwechsel und Korrosion. Diffusor aus getöntem Glas. **fr** Corps en métal. Résistant aux chocs thermiques et à la corrosion. Diffuseur en verre teinté. **it** Corpo in metallo. Resistente alle variazioni di temperatura e alla corrosione. Diffusore in vetro colorato. **es** Estructura metálica resistente al choque térmico y a la corrosión. Difusor de cristal tintado. **pl** Metalowy korpus odporny na szok termiczny i korozję. Klosz z barwionego szkła. **ru** Корпус из металла, устойчивый к перепадам температуры. Плафон из тонированного стекла.



● Bronze Antique / BZ



◀
S110-22-03-R
☉ 3xE27 100W
H: 2190, D: 550 mm,
□ d=215 / h=290,
IP54



▲
S110-10-01-R
☉ 1xE27 100W
H: 1050, D: 241 mm,
IP54



S101-10-41-B/R
 1x E27 60W
 H min: 520, H max: 1356,
 D: 188 mm,
 d1=188 / d2=121 / h=320,
 IP44

OXFORD

en Metal body. Resistant to thermal shock and corrosion. Clear glass diffuser. **de** Korpus aus Metall. Beständig gegen Temperaturwechsel und Korrosion. Diffusor aus klarem Glas. **fr** Corps en métal. Résistant aux chocs thermiques et à la corrosion. Diffuseur en verre clair. **it** Corpo in metallo. Resistente alle variazioni di temperatura e alla corrosione. Diffusore in vetro trasparente. **es** Estructura metálica resistente al choque térmico y a la corrosión. Difusor de cristal transparente. **pl** Metalowy korpus odporny na szok termiczny i korozję. Klosz z przezroczystego szkła. **ru** Корпус из металла, устойчивый к перепадам температуры. Плафон из прозрачного стекла.



● Black / B

● Bronze / BZ



▲
S101-42-11-R/B
☉ 1xE27 60W
H: 424, W: 163, L: 230 mm,
□ d1=188 / d2=121 / h=320,
IP44



▲
S101-42-01-B
☉ 1xE27 60W
H: 418, W: 163, L: 230 mm,
□ d1=188 / d2=121 / h=320,
IP44



◀
S101-108-51-R
☉ 1xE27 100W
H: 1094, D: 230 mm,
IP44



▲
S101-60-31-B
☉ 1xE27 60W
H: 584, D: 160 mm,
□ d1=188 / d2=121 / h=320,
IP44

ALPHABETICAL INDEX

ARM001-01-W	209	ARM369-03-G	221	C182-TL-01-B	48	DIA700-CL-03-G	275
ARM001-06-W	209	ARM369-05-G	221	C182-TL-01-W	48	DIA700-CL-06-G	275
ARM004-00-W	202	ARM369-33-G	221	C190-WL-02-W	57	DIA700-CL-12-G	274
ARM004-01-W	202	ARM390-00-W	218	C191-WL-02-W	57	DIA700-WL-02-G	275
ARM004-06-W	202	ARM390-01-W	218	C198-WL-01-12W-W	45	DIA750-PT50-WG	276
ARM004-11-W	202	ARM390-05-W	219	C198-WL-01-3W-W	45	DIA750-TT40-WG	276
ARM010-01-W	194	ARM390-33-W	218	C198-WL-01-6W-W	45	DIA750-TT50-WG	277
ARM010-02-W	194	ARM420-01-R	222	C232-CL-03-R	286	DIA750-WB01-WG	276
ARM010-06-W	194	ARM420-02-R	222	C286-WL-01-5W-W	47	DIA890-CL-05-G	270
ARM010-08-W	193	ARM420-03-R	222	C444-WL-01-13W-N	83	DIA890-CL-06-G	270
ARM010-11-W	194	ARM420-05-R	223	C444-WL-01-21W-N	83	DIA890-CL-10-G	271
ARM013-01-W	210	ARM420-22-R	222	C608-WL-01-W	49	DIA890-CL-18-G	270
ARM013-03-W	210	ARM526TL-01GR	192	C615CL-L40CH	179	DIA890-WL-01-G	271
ARM013-05-W	211	ARM526WL-01GR	192	C615CL-L60CH	179	DIA891-CL-14-G	271
ARM013-11-W	210	ARM548-01-WG	204	C6998-CL-45-W	177	DIA902-04-N	134
ARM013-22-W	211	ARM548-05-WG	204	C6999-CL-45-W	178	DIA902-06-N	134
ARM013-33-W	210	ARM548-11-WG	205	C6999-CL-75-W	178	DL001-1-01-W	67
ARM023-01-S	220	ARM855-TL-01-R	262	C804WL-L12W	59	DL002-1-01-W	67
ARM023-PL-03-S	220	ARM959-PL-04-G	230	C805WL-L7B	59	DL002-1-02-W	67
ARM029-01-W	201	ARM959-PL-06-G	230	C806WL-L5B	59	DL004-1-01-W	67
ARM029-11-W	201	ARM959-WL-02-G	230	C806WL-L5W	59	DL005-1-01-W	67
ARM029-PL-03-W	201	C001CW-01W	50	C807WL-L7W	59	DL006-1-01-W	67
ARM139-01-W	208	C002CW-01W	50	C808WL-L3B	59	DL008-2-01-B	69
ARM139-06-W	208	C003CW-01W	50	C808WL-L3W	59	DL008-2-01-S	69
ARM143-01-BG	206	C004CW-01W	50	C815WL-L12W	55	DL008-2-01-W	69
ARM143-07-BG	206	C005CW-01W	51	C815WL-L18W	55	DL008-2-02-B	69
ARM154-01-S	196	C006CW-01W	51	C815WL-L6W	55	DL008-2-02-S	69
ARM154-06-S	196	C007CW-01B	46	C900-CL-03-R/W	284	DL008-2-02-W	69
ARM154-PL-01-S	197	C007CW-01W	46	C900-CL-05-W/R	284	DL009-2-01-W	69
ARM172-01-G	212	C009CW-L12B	63	C906-CL-03-W	284	DL011-1-01W	66
ARM172-02-G	213	C009CW-L12W	63	C906-CL-04-W/R	284	DL012-1-01W	66
ARM172-05-G	213	C010CL-01B	52	C907-CL-02-W/R	285	DL023-2-01B	64
ARM172-08-G	212	C010CL-01W	52	C907-CL-03-R/W	285	DL023-2-01S	64
ARM172-11-G	213	C011CL-01W	53	C908-CL-03-W/R	287	DL023-2-01W	64
ARM172-22-G	213	C012CL-01B	52	C908-CL-04-R/W	287	DL024-2-01B	64
ARM247-00-G	217	C012CL-01W	52	C937-WL-01-12W-N	44	DL024-2-01S	64
ARM247-01-G	216	C013CL-01B	53	DIA002PL-05CH	127	DL024-2-01W	64
ARM247-02-G	216	C013CL-01W	53	DIA003-PT50-G	282	DL024-2-02B	64
ARM247-06-G	216	C014CL-01W	52	DIA004-01-G	281	DL024-2-02S	64
ARM247-08-G	216	C015CL-01B	53	DIA004-06-G	281	DL024-2-02W	64
ARM247-10-G	217	C015CL-01W	53	DIA004-08-G	280	DL024-2-03B	64
ARM247-11-G	217	C016CL-01B	52	DIA005CL-06CH	135	DL024-2-03S	64
ARM247-PL-01-G	216	C016CL-01W	52	DIA005CL-10CH	135	DL024-2-03W	64
ARM288-01-G	215	C017CW-01W	42	DIA008PL-05CH	136	DL025-2-01B/W	65
ARM288-05-G	215	C018CL-01W	42	DIA008PL-07CH	137	DL026-2-01B/W	65
ARM326-00-W	198	C019CW-01W	48	DIA008TL-01CH	136	DL027-2-01B	62
ARM326-01-W	198	C020CL-01B/W	61	DIA008WL-01CH	136	DL027-2-01W	62
ARM326-05-W	199	C021CL-02B/W	61	DIA100-CL-03-G/N	273	DL030-2-01W	62
ARM326-11-W	198	C024CL-L18B	42	DIA100-CL-12-G/N	273	DL031-2-L12B	73
ARM326-33-W	198	C024CL-L18W	42	DIA100-CL-16-G/N	272	DL031-2-L12W	73
ARM326-55-W	198	C035wl-I3b3k	46	DIA100-WL-02-N/G	273	DL031-2-L8B	73
ARM337-02-R	226	C035wl-I3W3k	46	DIA120-06-G	283	DL031-2-L8W	73
ARM337-05-R	226	C123-WL-02-3W-W	57	DIA120-09-G	283	DL032-2-01B	73
ARM337-07-R	226	C155-WL-02-3W-W	57	DIA522-CL-07-G	278	DL032-2-01W	73
ARM365-01-R	224	C176-WL-01-6W-B/W	43	DIA522-CL-12-G	279	DL033-2-01B	73
ARM365-04-R	224	C177WL-L12W	54	DIA522-WL-01-G	278	DL033-2-01W	73
ARM365-05-R	225	C177WL-L4W	54	DIA600-02-G/N	128	DL2001-L12B	70
ARM369-01-G	221	C177WL-L8W	54	DIA600-07-N/G	128	DL2001-L12W	70

DL2001-L7B.....	71	H300-04-G.....	243	MOD044-PL-01-N.....	139	MOD246-PL-01-BL.....	153
DL2001-L7W.....	71	H301-01-G.....	244	MOD044-PL-03-N.....	138	MOD246-PL-01-GN.....	153
DL278-1-01-W.....	293	H301-03-G.....	244	MOD044-WL-01-N.....	139	MOD246-PL-01-R.....	153
DL279-1-01-W.....	293	H301-04-G.....	244	MOD048PL-03G.....	106	MOD246-PL-01-TR.....	153
DL284-1-01-W.....	293	H351-TL-01-N.....	288	MOD048PL-06G.....	107	MOD267-PL-01.....	154
DL287-2-3W-W.....	69	H353-TL-01-BZ/N/W.....	239	MOD048PL-09G.....	106	MOD323-PL-01-W.....	112
DL289-2-01-W.....	69	H356-CL-03-CH/BZ.....	238	MOD048WL-02G.....	106	MOD323-TL-01-B/W.....	112
DL290-2-01-W.....	69	H357-PL-03-BG.....	254	MOD101PL-L47W.....	29	MOD334-PL-05-N.....	186
DL294-5-3W-WC.....	69	H357-PL-08-BG.....	255	MOD101PL-L88W.....	29	MOD334-PL-08-N.....	187
DL296-6-6W-W.....	63	H357-WL-01-BG.....	254	MOD102PL-L42B.....	24	MOD334-WL-01-N.....	186
DL297-6-6W-W.....	63	H428-PL-01-WG.....	228	MOD102PL-L42W.....	24	MOD362-CL-01-60W-W.....	176
DL300-2-01-CH.....	293	H428-PL-03-WG.....	228	MOD112-04-N/G.....	92	MOD407-PL-01-N/W.....	150
DL301-2-01-CH/G.....	293	H428-TL-01-WG.....	228	MOD112-08-G/N.....	93	MOD407-WL-01-N/W.....	150
DL302-2-01-G.....	293	H428-WL-01-WG.....	228	MOD112CL-08N/G.....	92	MOD431-PL-01-WS/WG.....	95
DL303-L12B.....	71	H601PL-01BS.....	231	MOD142-TL-01-N/B/GR/W121		MOD431-PL-06-WG/WS.....	94
DL303-L12W.....	71	H601PL-03BS.....	231	MOD142-WL-01.....	121	MOD431-TL-01-WS/WG.....	94
DL303-L7B.....	71	H899-01-W/R.....	236	MOD184-PL-01-CH.....	125	MOD431-WL-01-WS/WG.....	94
DL303-L7W.....	71	H899-11-R/W.....	236	MOD184-PL-04-CH.....	124	MOD446-01-N.....	77
H001CL-05BS.....	246	MIR002WL-L12CH.....	173	MOD184-WL-01-CH.....	125	MOD446-02-N.....	77
H001CL-07BS.....	247	MIR002WL-L14CH.....	173	MOD196-PL-02-W.....	90	MOD446-11-N.....	76
H001TL-01BS.....	246	MIR003WL-L12CH.....	172	MOD196-TL-01-W.....	90	MOD446-22-N.....	76
H001WL-01BS.....	246	MIR003WL-L16CH.....	172	MOD199-PL-03-W/G.....	155	MOD447-33-N.....	82
H002PL-06G.....	260	MIR003WL-L7CH.....	172	MOD200-02-N.....	78	MOD447-55-N.....	82
H002WL-01G.....	260	MIR004WL-L12B.....	174	MOD200-10-N.....	78	MOD447-CL-3-30-W.....	82
H002WL-02G.....	260	MIR004WL-L12BZ.....	174	MOD200-22-N.....	78	MOD448-44-N.....	31
H004CL-05BG.....	252	MIR004WL-L12BZ.....	174	MOD201PL-05N.....	131	MOD448-55-N.....	31
H004CL-07BG.....	253	MIR005WL-L16B.....	175	MOD201PL-07N.....	131	MOD448-CL-4-30-W.....	30
H004WL-01BG.....	252	MIR005WL-L16W.....	175	MOD201PL-08N.....	131	MOD448-CL-5-45-W.....	31
H005WL-01BG.....	252	MOD003PL-L27WG.....	97	MOD206-01-N.....	188	MOD470-TL-01-W/B.....	164
H006PL-03G.....	248	MOD003PL-L27WS.....	96	MOD206-02-N.....	188	MOD527PL-06N.....	111
H006PL-05G.....	249	MOD003PL-L54WG.....	96	MOD206-08-N.....	189	MOD527WL-01N.....	111
H006TL-01G.....	248	MOD003PL-L54WS.....	96	MOD211-06-N.....	80	MOD541PL-01G/W.....	116
H006WL-01G.....	248	MOD009PL-05N.....	110	MOD211-09-N.....	81	MOD542PL-01W.....	117
H007PL-04G.....	250	MOD009TL-01N.....	110	MOD217-40-N.....	130	MOD542TL-01G/W.....	116
H007PL-05G.....	251	MOD009WL-01N.....	110	MOD217-50-N.....	130	MOD543PL-01W.....	116
H007WL-01G.....	250	MOD012CL-06G.....	96	MOD221-FL-01-G.....	103	MOD544PL-01B.....	119
H009PL-06G.....	259	MOD012CL-12G.....	96	MOD221-FL-01-N.....	104	MOD544TL-01B.....	119
H009PL-08G.....	258	MOD012PL-02G.....	97	MOD221-PL-01-G.....	103	MOD544WL-01B.....	119
H018-FL-01-NG.....	257	MOD012WL-02G.....	96	MOD221-PL-01-N.....	104	MOD545PL-12CH/G.....	109
H018-PL-06-NG.....	256	MOD013PL-02B/W.....	100	MOD221-PL-05-G.....	103	MOD545PL-20CH/G.....	109
H018-PL-08-NG.....	257	MOD013PL-04B/W.....	100	MOD221-PL-08-G/N.....	102-5	MOD545PL-24CH/G.....	109
H018-TL-01-NG.....	257	MOD013PL-06B/W.....	101	MOD221-PL-12-G.....	102	MOD547PL-25G/CH.....	109
H018-WL-01-NG.....	257	MOD014CL-06N.....	182	MOD221-PL-12-N.....	104	MOD547WL-05G/CH.....	108
H034-PL-01-R.....	232	MOD014CL-08N.....	183	MOD221-TL-01-G.....	103	MOD547WL-09G/CH.....	108
H034-WL-02-R.....	232	MOD014FL-01N.....	182	MOD221-TL-01-N.....	104	MOD547WL-13G/CH.....	108
H099-03-B.....	240	MOD014TL-01N.....	182	MOD221-WL-01-G.....	102	MOD548PL-25G/CH.....	108
H099-05-B.....	240	MOD014WL-01N.....	182	MOD221-WL-01-N.....	104	MOD600PL-06W.....	89
H186-PL-01-40W-BS.....	132	MOD015CL-L80B.....	22	MOD221-WL-02-G.....	102	MOD600PL-09W.....	88
H186-PL-01-46W-BS.....	133	MOD015CL-L80W.....	22	MOD221-WL-02-N.....	104	MOD600PL-10W.....	89
H186-PL-01-53W-BS.....	132	MOD016PL-L75B.....	22	MOD238-PL-01-B.....	151	MOD600WL-02W.....	89
H186-PL-01-61W-BS.....	133	MOD016PL-L75W.....	23	MOD238-PL-01-BL.....	151	MOD602-00-N.....	191
H186-PL-01-73W-BS.....	133	MOD029-PL-01-W.....	113	MOD238-PL-01-GN.....	151	MOD602-01-N.....	191
H223-PL-03-G.....	229	MOD029-TL-01-W.....	113	MOD238-PL-01-TR.....	151	MOD602-04-N.....	191
H223-PL-05-G.....	229	MOD030PL-01GR.....	115	MOD239-05-B.....	118	MOD602-06-N.....	190
H223-WL-01-G.....	229	MOD030PL-05GR.....	115	MOD239-11-B.....	118	MOD602-FL-01-N.....	191
H223-WL-02-G.....	229	MOD030PL-06GR.....	115	MOD242-PL-01-AM.....	148	MOD602-TL-01-N.....	191
H260-00-N.....	234	MOD033-PL-01-N.....	139	MOD242-PL-01-BL.....	148	MOD603-01-N.....	184
H260-02-N.....	234	MOD033-PL-03-N.....	139	MOD242-PL-01-GN.....	149	MOD603-06-N.....	184
H260-03-N.....	234	MOD033-WL-01-N.....	139	MOD242-PL-01-R.....	149	MOD603-08-N.....	185
H260-05-N.....	235	MOD043PL-04CH.....	126	MOD242-PL-01-TR.....	148	MOD603-11-N.....	185
H300-03-G.....	242	MOD043PL-06CH.....	126	MOD246-PL-01-AM.....	153	MOD611TL-01GR.....	122
		MOD043WL-01CH.....	126				

MOD613CL-04GR.....	113	O803WL-L6B.....	325	RC855-PL-06-R.....	262	T450-PL-01-B.....	310
MOD614FL-02BS.....	120	O803WL-L6W.....	325	RC855-WL-01-R.....	262	T451-PL-01-GR.....	313
MOD614PL-01BS.....	120	P001PL-01BZ.....	142	S101-10-41-B/R.....	336	T452-PL-01-GR.....	311
MOD617CL-04GR.....	113	P002PL-01BZ.....	142	S101-108-51-R.....	337	T455-05-BASE.....	314
MOD618TL-01W.....	123	P003PL-01BZ.....	142	S101-42-01-B.....	337	T455-08-BASE.....	314
MOD618WL-01W.....	123	P010PL-L23B/W.....	38	S101-42-11-R/B.....	337	T455-10-BASE.....	314
MOD619PL-01GR.....	122	P010PL-L30W/B.....	38	S101-60-31-B.....	337	T455-14-BASE.....	314
MOD619TL-01GR.....	122	P012-PL-01-N.....	143	S104-10-41-R.....	333	T532CL-08B.....	300
MOD700-04-W.....	86	P012-PL-03-N.....	143	S104-119-51-R.....	333	T532CL-12B.....	300
MOD807TL-L18W.....	28	P015PL-01BS/W/B.....	162	S104-59-31-R.....	333	T532WL-02B.....	300
MOD809-CL-03-36-W.....	84	P016PL-01B/BS/W.....	162	S110-10-01-R.....	335	T546PL-12B.....	296
MOD809-CL-04-48-W.....	84	P017PL-01BS/B/W.....	162	S110-22-03-R.....	335	T546PL-18B.....	297
MOD809-CL-06-72-WB/W.....	84	P018-PL-01-N.....	161	SPR-BASE-03-B/W.....	315	TR002-1-GU10-B.....	35
MOD833-08-N.....	87	P019-PL-01-N.....	161	SPR-BASE-R-02-W/B.....	315	TR002-1-GU10-W.....	35
MOD877PL-L110W.....	26	P019-PL-01-W.....	157	SPR-BASE-R-03-B+.....	315	TR003-1-12W3K-B.....	32
MOD877PL-L24W.....	26	P020PL-01S/W/B.....	40	SPR-BASE-R-03-B/W.....	315	TR003-1-12W3K-W.....	32
MOD877PL-L36W.....	26	P021PL-L10B/W.....	41	T018-01-B.....	306	TR003-1-12W4K-B.....	32
MOD877PL-L48W.....	26	P111-PL-225-G.....	159	T018-03-B.....	306	TR003-1-12W4K-W.....	32
MOD877PL-L60W.....	29	P140-PL-110-1-N.....	144	T021-01-B.....	299	TR003-1-17W3K-B.....	34
MOD877PL-L62W.....	27	P140-PL-170-1-N.....	144	T021-03-B.....	299	TR003-1-17W3K-W.....	34
MOD877PL-L70W.....	29	P140-PL-170-5-N.....	145	T062-PL-16-B/W.....	304	TR003-1-17W4K-B.....	32
MOD877PL-L85W.....	25	P225-PL-150-N.....	146	T062-PL-23-W/B.....	304	TR003-1-17W4K-W.....	32
MOD877TL-L18W.....	28	P225-PL-200-N.....	146	T162-00-B.....	160	TR003-1-30W3K-B.....	34
MOD877WL-L12W.....	28	P225-PL-300-N.....	146	T162-01-B.....	160	TR003-1-30W3K-W.....	34
MOD877WL-L13W.....	28	P225-PL-400-N.....	147	T163-01-C.....	163	TR003-1-30W4K-B.....	34
MOD877WL-L18W.....	28	P229-PL-01-GR.....	149	T163-01-R.....	163	TR003-1-30W4K-W.....	34
MOD981-PL-01-B.....	114	P229-PL-01-W.....	149	T163-01-W.....	163	TR003-1-6W3K-B.....	32
MOD999-44-W.....	85	P244-PL-01-N.....	143	T163-11-C.....	163	TR003-1-6W3K-W.....	32
O010FL-01B.....	328	P244-PL-03-N.....	143	T163-11-R.....	163	TR003-1-6W4K-B.....	34
O010FL-02B.....	328	P318PL-01B/W/N.....	39	T163-11-W.....	163	TR003-1-6W4K-W.....	34
O010WL-01B.....	328	P359-PL-01-W.....	156	T163PL-01C.....	163	TR004-1-GU10-B.....	35
O010WL-02B.....	328	P359-PL-140-C/W.....	156	T163PL-01R.....	163	TR004-1-GU10-W.....	35
O011FL-L6B.....	322	P359-PL-220-C.....	156	T163PL-01W.....	163	TR005-1-GU10-B.....	35
O011WL-L6B.....	322	P359-PL-350-C.....	156	T164-01-G.....	307	TR005-1-GU10-W.....	35
O572WL-L6B.....	321	P361PL-01G.....	140	T164-01-N.....	307	TR008-1-GU10-B.....	34
O572WL-L6GR.....	320	P362PL-01G.....	140	T164-11-G.....	307	TR008-1-GU10-W.....	34
O572WL-L6W.....	320	P363PL-01G.....	140	T164-11-N.....	307	TRA001B-11B/W.....	36
O573WL-L6B.....	320	P364PL-01B.....	140	T187-PL-01-B.....	309	TRA001C-11B/W.....	36
O573WL-L6GR.....	320	P364PL-01G.....	140	T192-PL-01-B.....	309	TRA001CF-11B/W.....	36
O573WL-L6W.....	321	P530PL-01W.....	148	T193-PL-01-B.....	309	TRA001CL-11B/W.....	36
O574WL-01B.....	327	P531PL-01W.....	144	T194-PL-01-B.....	309	TRA001CT-11B/W.....	36
O574WL-02B.....	327	P534PL-01PN/B/GR/W.....	158	T195-PL-01-B.....	309	TRA001CW-11B/W.....	36
O575WL-L6B.....	324	P535PL-01GR/PN/B/W.....	158	T268-PL-01-BS.....	308	TRA001CX-11B/W.....	36
O575WL-L6W.....	324	PIC113-02-R/G/W.....	291	T268-PL-01-W.....	308	TRA001EC-11B/W.....	36
O576FL-01B.....	327	PIC114-02-G/R/W.....	291	T314-00-B.....	160	TRX001-111B.....	35
O576WL-01B.....	327	PIC117-01-R/W.....	290	T314-01-B.....	160	TRX001-111W.....	35
O576WL-02B.....	327	PIC118-22-R/W.....	290	T314-11-B.....	160	TRX001-112B.....	35
O577WL-L5B.....	326	PIC119-44-R.....	292	T354-PL-01-B.....	300	TRX001-112W.....	35
O578FL-01B.....	330	PIC119-44-W.....	292	T354-PL-04-B.....	300	Z001FL-L3W-1B/W.....	169
O578WL-01B.....	330	RC0100-PL-05-R.....	264	T354-WL-01-B.....	300	Z010FL-L8B3K.....	171
O578WL-02B.....	330	RC0100-TL-01-R.....	264	T432-PL-01-G.....	302	Z010FL-L8W3K.....	171
O580WL-L6B.....	319	RC0100-WL-01-R.....	264	T432-PL-03-G.....	303	Z010TL-L8B3K.....	171
O580WL-L6W.....	319	RC015-PL-01-G.....	268	T433-PL-01-GR.....	313	Z010TL-L8W3K.....	171
O581WL-L6B.....	319	RC247-FL-01-R.....	267	T434-PL-01-GR.....	313	Z137-TL-01-GR/W.....	166
O581WL-L6W.....	319	RC247-PL-01-R.....	266	T436-PL-01-GR.....	311	Z147-TL-01-B.....	167
O583WL-L10B.....	323	RC247-PL-06-R.....	266	T437-PL-01-GR.....	313	Z147-TL-01-W.....	167
O584WL-L10B.....	323	RC247-PL-08-R.....	266	T438-PL-01-GR.....	313	Z147-TL-01-YE.....	167
O594WL-L6GR.....	318	RC247-PL-10-R.....	267	T439-PL-01-GR.....	313	Z148-TL-01-E.....	165
O594WL-L6W.....	318	RC247-TL-01-R.....	266	T440-PL-01-GR.....	313	Z153-TL-01-BS.....	289
O802WL-L7B.....	326	RC247-WL-01-R.....	266	T442-PL-01-B.....	306	Z177-FL-01-BR.....	168
O802WL-L7W.....	326	RC247-WL-02-R.....	266	T443-PL-01-B.....	306	Z329-FL-01-CH.....	170

MAYTONI

DECORATIVE LIGHTING

www.maytoni.de

+49 (30) 555 722 45

